

# **Ministry of Health Drinking Water Quality Guidelines for New Zealand**

# Chapter 1: Introduction

## Contents

|            |  |           |
|------------|--|-----------|
| <b>1.1</b> | <b>Introduction</b>  | <b>3</b>  |
| 1.1.1      | Purpose of the guidelines  | 3         |
| 1.1.2      | Background   | 4         |
| 1.1.3      | Waterborne diseases in New Zealand   | 5         |
| 1.1.4      | The cost of providing potable drinking-water   | 13        |
| 1.1.5      | The benefits of potable drinking-water supplies  | 14        |
| <b>1.2</b> | <b>Ministry of Health public health protection strategy for drinking-water 1993–1995</b>               | <b>18</b> |
| 1.2.1      | Strategy development   | 18        |
| 1.2.2      | Outline of the strategy  | 19        |
| 1.2.3      | Planned milestones   | 19        |
| 1.2.4      | Desired outcomes   | 20        |
| 1.2.5      | Promotion of awareness of public health issues related to drinking-water                               | 20        |
| 1.2.6      | Outputs achieved by 1995   | 20        |
| <b>1.3</b> | <b>Strategy development 1995–2000</b>  | <b>21</b> |
| 1.3.1      | Consultation   | 21        |
| 1.3.2      | Inclusion of protozoa in the DWSNZ   | 22        |
| 1.3.3      | Human resource development   | 22        |
| 1.3.4      | DWSNZ 2000   | 22        |
| <b>1.4</b> | <b>Strategy development 2000–2005</b>  | <b>23</b> |
| 1.4.1      | Consultation   | 23        |
| 1.4.2      | Water safety plans   | 23        |
| 1.4.3      | Legislative development  | 24        |
| 1.4.4      | Development of the DWSNZ 2005  | 25        |
| 1.4.5      | Development of the drinking-water assistance programme   | 27        |
| <b>1.5</b> | <b>Operational development of the drinking-water management programme 2005–2009</b>                    | <b>28</b> |
| 1.5.1      | The Drinking-water Assistance Programme, DWAP  | 28        |
| 1.5.2      | Legislation: The Health (Drinking Water) Amendment Act 2007 (Part 2a of the Health Act 1956 – the Act) | 29        |
| 1.5.3      | The 2008 revision of DWSNZ 2005  | 30        |

|  |  |           |
|--|--|-----------|
| 1.5.4  | Tankered drinking-water supplies   | 30        |
| 1.5.5  | Development of specifications for Rural Agricultural Drinking-water Supplies (RADWS) | 31        |
| 1.5.6  | Point-of-use and point-of-entry drinking-water treatment appliances standards        | 31        |
| <b>1.6</b>   | <b>Tools for promoting potable drinking-water supplies</b>                           | <b>32</b> |
| 1.6.1  | Introduction   | 32        |
| 1.6.2  | Four tools used by the World Health Organization                                     | 33        |
| 1.6.3  | The six guiding principles of drinking-water safety                                  | 33        |
| 1.6.4  | Drinking-water Standards for New Zealand   | 35        |
| 1.6.5  | Guidelines for Drinking-water Quality Management in New Zealand                      | 39        |
| 1.6.6  | Water safety plans   | 39        |
| 1.6.7  | Public health grading of drinking-water supplies                                     | 40        |
| 1.6.8  | Drinking-water assessment  | 41        |
| 1.6.9  | Monitoring   | 41        |
| 1.6.10   | Surveillance   | 42        |
| 1.6.11   | Identifying priority 2 and priority 3 determinands                                   | 42        |
| 1.6.12   | Register of Community Drinking-water Supplies and Suppliers in New Zealand           | 43        |
| 1.6.13   | Annual Review of Drinking-water Quality in New Zealand                               | 43        |
| 1.6.14   | Register of recognised laboratories  | 44        |
| 1.6.15   | Records  | 44        |
| <b>1.7</b>   | <b>Other drinking-water requirements</b>   | <b>46</b> |
| 1.7.1  | Drinking-water quality at airports   | 46        |
| 1.7.2  | Drinking-water quality in shipping   | 46        |
| <b>1.8</b>   | <b>Emergency supplies and emergencies</b>  | <b>47</b> |
| <b>Appendix 1: Statistical issues that relate to the Drinking-water Standards of New Zealand</b> |  | <b>48</b> |
| A1   | Compliance rules for percentile standards  | 49        |
| A2   | Handling non-detects   | 55        |
| <b>References</b>  |  | <b>56</b> |

## List of tables

|             |  |    |
|-------------|--|----|
| Table 1.1:  | Numbers and rates of notifiable diseases with waterborne transmission potential, 2004–2013   | 9  |
| Table 1.2:  | Number of outbreaks and associated cases recorded for enteric disease and waterborne enteric disease, 2004–2013  | 10 |
| Table 1.3:  | Documented waterborne outbreaks in New Zealand, with probable links to drinking water, 2005–2016   | 11 |
| Table 1.4:  | Economic benefits arising from water and sanitation improvements   | 15 |
| Table 1.5:  | Examples of priority allocation in the DWSNZ   | 43 |
| Table A1.1: | Numbers of samples and allowable transgressions needed to keep maximum risks below 5 percent when assessing compliance with a 95th percentile standard | 51 |
| Table A1.2: | Allowable exceedances (for 95 percent confidence that the MAV is exceeded for no more than 5 percent of the time)                                      | 54 |

## List of figures

|             |   |    |
|-------------|---|----|
| Figure 1.1: | Epidemic versus endemic/sporadic disease  | 12 |
| Figure A1:  | Bayesian confidence of compliance curves for a 95th percentile standard, using Jeffreys' uninformative        | 52 |
| Figure A2:  | Fitting a lognormal distribution to >L data (where L = 5), and extrapolating back to obtain values of <L data | 56 |

# 1.1 Introduction

## 1.1.1 Purpose of the guidelines

A wide range of gastrointestinal diseases can be caused by ingestion of food or drink that is contaminated by pathogenic micro-organisms or by toxic chemicals. Control of these is an important feature of public health. This is done by regulating food safety, administered by the Ministry of Primary Industries and regulating safety of community drinking-water supplies, administered by the Ministry of Health.

The purpose of these *Guidelines for Drinking-water Quality Management for New Zealand* is to provide information on the tools used by the Ministry of Health to promote the provision, by suppliers, of drinking-water that is safe to drink. The development of these tools commenced in 1993. This introduction to the *Guidelines* puts the Ministry's tools in their historical context.



## 1.1.2 Background

In 1992 the public health oversight of drinking-water quality management in New Zealand was in disarray after five years of central and local government restructuring and retrenchment. The (then) Department of Health was receiving little information about the quality of public drinking-water supplies (Taylor 1993a). However, an independent survey (Ogilvie 1989) had shown that at least 45 to 50 percent of water suppliers did not monitor their chlorine dosage satisfactorily, 28 percent never tested the bacteriological quality of water after it entered the distribution system, and another 30 percent tested only four times per year. Thus, for most of the year, the microbiological quality of the water was unknown. In 1991 bacterial quality was reported for just 462 of the water supplies in New Zealand. As the drinking-water management tools came into operation the number of known supplies increased until, as at April 2015, 1,470 community water supplies were listed on the Register of Drinking-water Suppliers for New Zealand.

After the Department of Health was restructured into the Ministry of Health in 1993, an initial appraisal of the public health safety management of the drinking-water industry was carried out (Taylor 1993a, 1993b). The opportunity was taken to review and restructure the process of public health management of drinking-water. There were also a number of major governance and structural issues surrounding the management of the water resources and the water industry that might have benefited from review, but responsibility for these lay outside the health portfolio. Therefore the Ministry of Health concentrated on the public health infrastructure, although it has contributed where possible to various governance and structural reviews on related topics carried out by other agencies.

It soon became evident that there were a large number of small supplies about which little or nothing was known, even though the larger municipal supplies were generally well-managed and safe, there were some whose standards were not as good as could be desired.

The Ministry of Health is responsible for the regulation of public health under the Health Act 1956 and subsequent amendments. This includes overview of drinking-water supplies to ensure that the water from these supplies can be drunk without causing illness. A potable drinking-water supply is a fundamental pre-requisite of public health.

In 1993 the World Health Organization (WHO) published the second edition of its *Guidelines for Drinking-water Quality* which updated the information on drinking-water quality requirements from the first (1983) edition. The Ministry of Health used the information in the WHO Guidelines, and the knowledge of deficiencies in the public health management of drinking-water that it had gained from its own review in New Zealand, to publish revised *Drinking-water Standards for New Zealand* in 1995 and to develop a strategic plan and tools to improve the public health safety of New Zealand drinking-water. The standards were further updated in 2000, 2005, and again in 2008.

The *Drinking-water Standards for New Zealand 2000* updated the analytical methods for drinking-water quality and made some minor changes to improve the interpretation and robustness.

Additional new material was included in the *Drinking-water Standards for New Zealand 2005* (DWSNZ) to accommodate the advances that had occurred in the previous five years. This included protocols for the use of ultraviolet light disinfection to inactivate bacteria and protozoa, radically restructuring sections relating to protozoal compliance, and sections on cyanotoxins, small supplies, and tankered drinking-water. New information from the WHO *Guidelines for Drinking-water Quality* (3rd edition, 2004) was included.

The current Standards are *Drinking-water Standards for New Zealand 2005* (revised 2008). They have two main components:

- public health standards for drinking-water quality which list the maximum concentrations of chemical, radiological and microbiological contaminants that can be present in drinking-water without presenting a public health risk
- compliance criteria for community water supplies which specify the sampling frequencies and testing procedures needed to demonstrate with 95 percent confidence that the water complies with the DWSNZ for at least 95 percent of the time, and provide for lesser confidence levels for smaller supplies.

Though the DWSNZ provide performance criteria for drinking-water quality management they do not specify how the quality of water supplies should be managed. That is discussed in this publication, the *Guidelines for Drinking-water Quality Management in New Zealand*, which forms the companion volume to the DWSNZ.

The water properties addressed in the DWSNZ relate to health significance, not to aesthetic qualities. The *Guidelines for Drinking-water Quality Management in New Zealand* (the Guidelines) explain the principles underlying the DWSNZ, how the Maximum Acceptable Values (MAVs) for determinands in drinking-water were derived, and the part that aesthetic quality plays in producing a potable, wholesome and acceptable community drinking-water. The Ministry's drinking-water quality management tools and the scope of the Guidelines are discussed in more detail in section 1.3.

### 1.1.3 Waterborne diseases in New Zealand

Untreated or inadequately treated drinking-water contaminated with pathogens presents a significant risk to human health. In New Zealand, the overall burden of endemic drinking-waterborne gastrointestinal disease has been estimated at 18,000 to 34,000 cases per year (Ball 2007). Attributing the cause of illness can be complicated by the lack of data collected at the time.

Following recent outbreaks in Canada (eg, Walkerton), Schuster et al (2005) analysed 288 outbreaks in Canada between 1974 and 2001. They found 99 outbreaks (34 percent) occurred in areas served by public supplies, 138 (48 percent) in semi-public supplies (private supplies but providing drinking-water to the public), and 51 (18 percent) in private supplies. The causative organisms, in descending frequency of occurrence, were: *Giardia*, *Campylobacter*, *Cryptosporidium*, Norwalk-type viruses, *Salmonella*, and hepatitis A virus.

In New Zealand, giardiasis, campylobacteriosis, cryptosporidiosis, salmonellosis and as well as acute gastroenteritis in general, are commonly reported enteric diseases with waterborne transmission potential. Norovirus (reported under acute gastroenteritis) also commonly causes waterborne illness, however, it is not notifiable unless the cases are related to an outbreak. Table 1.1 shows the numbers and rates of notifiable diseases with waterborne transmission potential for the period 2004–2013.

Over the last 10 years, approximately 3 to 10% of enteric disease outbreaks in New Zealand recorded a mode of transmission as waterborne. Table 1.2 shows the number of outbreaks and associated cases recorded for enteric diseases and waterborne enteric diseases for the period 2004–2013.

The numbers and rates of potentially waterborne illness notified and reported in Tables 1.1 and 1.2 are known to underestimate the actual burden of illness in the community because not all people who become ill are accounted for in the notifiable disease statistics. Reasons for this include:

- some people are infected but asymptomatic
- some people that are ill do not visit a doctor
- a doctor may fail to report a suspected case
- a doctor may not request faecal specimens
- some people may not submit the requested faecal specimens
- many other potentially waterborne illnesses are not notifiable (eg, norovirus cases – unless outbreak related, or sporadic gastroenteritis cases).

A New Zealand study estimated that out of every 222 community cases of acute gastroenteritis illness only one case is reported to the notification system, Lake et al 2009; Wheeler et al 1999 suggest that only a minority of cases get reported in England.

The term 'waterborne potential' is used here for any illness that could potentially be transmitted by water. This does not mean that an illness was actually transmitted by water. A large number of gastrointestinal infections are associated with other transmission routes (eg, foodborne, person-to person or environmental transmission, eg, Reilly et al 2004). The proportion attributable to each transmission route varies by disease. Finally, only a proportion of those that are linked to waterborne transmission will be directly associated with drinking-water. Other possible waterborne transmission routes include contact with recreational water. But this is not cause for complacency for at least four reasons.

First, the majority of the disease burden occurs in sporadic or endemic cases, not in detected outbreaks<sup>1</sup> (Figure 1.1 demonstrates the distinction between these terms). Therefore, given the publicity that outbreaks attract, the sporadic disease prevalence may be underestimated. To elaborate, some illnesses may often occur in outbreaks (eg, cryptosporidiosis) and so can receive a lot of publicity (eg, Baker et al 1998 and associated news items). Indeed there is a whole book devoted to analysis of outbreaks attributed to poor drinking-water supplies (Hrudey and Hrudey 2004),<sup>2</sup> including a New Zealand water supply example. However, other illnesses, such as campylobacteriosis, are usually less associated with outbreaks (although these can happen, particularly when water treatment systems are not operated well).<sup>3</sup> Health scientists are now in broad agreement that outbreaks form only a minor part of the total drinking-water related illness burden. For example, Dr Jamie Bartram of WHO, in introducing a section on *Investigation of Sporadic Waterborne Disease* in an authoritative text on drinking-water and disease (Hunter et al 2003), states that “a large proportion, and probably the vast majority, of waterborne disease burden arises outside of detected outbreaks. This statement contrasts with the view, predominant until only a few years ago and still periodically heard, that the failure to detect outbreaks of waterborne disease illustrates that this route of disease transmission is largely conquered in industrialised countries” (Bartram 2003).

Second, to identify the endemic and sporadic cases, special epidemiological investigations must be conducted to see if those cases are associated with drinking-water. Because of the cost of resources required to carry out such a study such work is usually not done. When such studies are performed, an association with the degree of drinking-water treatment is often identified. This has been found both overseas (Payment 2003, Hunter et al 2003) and in New Zealand. The New Zealand studies include giardiasis in a city in which two water supplies drawn from the same source received different levels of treatment (Dunedin, Fraser and Cooke 1991); campylobacteriosis in a number of rural water supplies (Eberhardt-Phillips et al 1997), and a Hawkes Bay college; cryptosporidiosis in many communities (Duncanson et al 2000); and microbial and chemical contamination of roof-collected rainwater supplies in Auckland, and associated illnesses (Simmons et al 2001).

<sup>1</sup> For reporting purposes the outbreak case definition is “two or more cases linked to a common source” (ESR 2002 Disease Outbreak Manual p2 (download [www.surv.esr.cri.nz](http://www.surv.esr.cri.nz))). The sensitivity of surveillance for diseases will often be less, particularly for common enteric diseases where only a small proportion of those infected will advise health officials thereby reducing the chances of identifying a common source.

<sup>2</sup> Outbreaks of cryptosporidiosis in Milwaukee (USA) and pathogenic *E. coli* in Walkerton (Canada) are the most recent serious examples, where numbers of people died and others gained life-long health impairment (usually renal failure).

<sup>3</sup> New Zealand examples include: Queenstown (Thorstensen 1985), Canterbury (Briesman 1987, Stehr-Green et al 1991), Hawkes Bay (McElnay and Inkson 2002). The 1984 Queenstown outbreak affected an estimated 3,500 people, and at least one person affected has since required continual kidney dialysis.

Third, there is a substantial level of faecal contamination of New Zealand freshwaters, including *Campylobacter*, enteroviruses and adenoviruses, even at recreational and water supply abstraction sites (McBride et al 2002). Human and livestock wastes may contain large numbers of pathogens that can present a major threat to public health if released into the environment and result in substantial health costs. Numerous waterborne outbreaks of infectious enteric diseases worldwide have been associated with discharge of effluents and agricultural runoff resulting in human exposure to faecal-contaminated water. Luckily, in general, the larger New Zealand drinking-water supplies are well-managed and generally well-sourced. This has minimised the potential disease level that could have been expected from the level of microbiological contamination of some of the source waters. Cysts and oocysts of protozoan parasites such as *Giardia* and *Cryptosporidium* are frequently found in environmental waters especially in areas of intensive livestock farming (Ionas et al 1999). In the UK, significant costs ranging from £15 to 30 million per annum have been estimated (Pretty et al 2000) to result from the agricultural contamination of drinking-water with zoonoses (diseases transmitted from animals to humans) such as *Cryptosporidium*.

Finally, despite careful and extensive examination of New Zealand drinking waters failing to find any trace of *Campylobacter* in well-treated and disinfected drinking-water supplies, it is present in almost all riverine source water.<sup>4</sup>

In his evidence to the Havelock North inquiry, Dr S Hrudehy (2017) stated:

In closing, the common theme across all of the international outbreak evidence is one of complacency. Our affluent societies have known for many decades how to prevent outbreaks yet we continue to allow them to happen by failing to do what we know needs to be done. In this sense, an analogy may be drawn with recurring outbreaks of communicable diseases like measles and mumps that occur because of a failure to maintain adequate immunization. These circumstances reveal the inevitable tension between individual rights and societal benefit. In the case of drinking water, individual biases about water disinfection and treatment should not be allowed to endanger innocent consumers, especially when such biases are based on urban myths and are not founded on authentic public health evidence.

<sup>4</sup> A preliminary study occasionally found small concentrations of *Campylobacter* in finished well-treated New Zealand water supplies (Savill et al 2001), but a subsequent full-scale study, using altered laboratory procedures, has failed to repeat that finding (Nokes et al 2004).

**Table 1.1: Numbers and rates of notifiable diseases with waterborne transmission potential, 2004–2013**

| Notifiable disease      | 2004          |                   | 2005          |                   | 2006          |                   | 2007          |                   | 2008          |                   | 2009          |                   | 2010          |                   | 2011          |                   | 2012          |                   | 2013          |                   |
|-------------------------|---------------|-------------------|---------------|-------------------|---------------|-------------------|---------------|-------------------|---------------|-------------------|---------------|-------------------|---------------|-------------------|---------------|-------------------|---------------|-------------------|---------------|-------------------|
|                         | Cases         | Rate <sup>1</sup> | Cases         | Rate <sup>1</sup> | Cases         | Rate <sup>1</sup> | Cases         | Rate <sup>1</sup> | Cases         | Rate <sup>1</sup> | Cases         | Rate <sup>1</sup> | Cases         | Rate <sup>1</sup> | Cases         | Rate <sup>1</sup> | Cases         | Rate <sup>1</sup> | Cases         | Rate <sup>1</sup> |
| Campylobacteriosis      | 12,215        | 298.8             | 13,836        | 334.7             | 15,873        | 379.3             | 12,778        | 302.2             | 6,694         | 156.8             | 7,177         | 166.3             | 7,346         | 168.2             | 6,686         | 151.8             | 7,016         | 158.3             | 6,837         | 152.9             |
| Cryptosporidiosis       | 611           | 14.9              | 888           | 21.5              | 737           | 17.6              | 924           | 21.9              | 764           | 17.9              | 854           | 19.8              | 954           | 21.8              | 610           | 13.8              | 877           | 19.8              | 1,348         | 30.1              |
| Gastroenteritis (acute) | 1,363         | 33.3              | 557           | 13.5              | 937           | 22.4              | 622           | 14.7              | 686           | 16.1              | 712           | 16.5              | 493           | 11.3              | 567           | 12.9              | 735           | 16.6              | 558           | 12.5              |
| Giardiasis              | 1,514         | 37.0              | 1,231         | 29.8              | 1,214         | 29.0              | 1402          | 33.2              | 1,660         | 38.9              | 1,639         | 38.0              | 1,985         | 45.4              | 1,934         | 43.9              | 1,714         | 38.7              | 1,729         | 38.7              |
| Hepatitis A             | 49            | 1.2               | 51            | 1.2               | 123           | 2.9               | 42            | 1                 | 89            | 2.1               | 44            | 1.0               | 46            | 1.1               | 26            | 0.6               | 82            | 1.8               | 91            | 2.0               |
| Legionellosis           | 62            | 1.5               | 85            | 2.1               | 52            | 1.2               | 64            | 1.5               | 73            | 1.7               | 74            | 1.7               | 173           | 4.0               | 158           | 3.6               | 150           | 3.4               | 151           | 3.4               |
| Leptospirosis           | 102           | 2.5               | 85            | 2.1               | 87            | 2.1               | 66            | 1.6               | 118           | 2.8               | 69            | 1.6               | 81            | 1.9               | 68            | 1.5               | 108           | 2.4               | 59            | 1.3               |
| Paratyphoid fever       | 28            | 0.7               | 25            | 0.6               | 23            | 0.5               | 23            | 0.5               | 25            | 0.6               | 25            | 0.6               | 19            | 0.4               | 13            | 0.3               | 22            | 0.5               | 25            | 0.6               |
| Salmonellosis           | 1,081         | 26.4              | 1,382         | 33.4              | 1,335         | 31.9              | 1275          | 30.2              | 1,339         | 31.4              | 1,128         | 26.1              | 1,146         | 26.2              | 1,055         | 23.9              | 1,081         | 24.4              | 1,143         | 25.6              |
| Shigellosis             | 140           | 3.4               | 183           | 4.4               | 102           | 2.4               | 129           | 3.1               | 113           | 2.6               | 119           | 2.8               | 104           | 2.4               | 101           | 2.3               | 132           | 3.0               | 137           | 3.1               |
| Typhoid fever           | 31            | 0.8               | 30            | 0.7               | 42            | 1.0               | 48            | 1.1               | 29            | 0.7               | 34            | 0.8               | 31            | 0.7               | 45            | 1.0               | 44            | 1.0               | 50            | 1.1               |
| VTEC/STEC infection     | 89            | 2.2               | 92            | 2.2               | 87            | 2.1               | 100           | 2.4               | 124           | 2.9               | 143           | 3.3               | 138           | 3.2               | 153           | 3.5               | 147           | 3.3               | 205           | 4.6               |
| Yersiniosis             | 407           | 10.0              | 383           | 9.3               | 453           | 10.8              | 502           | 11.9              | 508           | 11.9              | 430           | 10.0              | 406           | 9.3               | 513           | 11.6              | 514           | 11.6              | 485           | 10.8              |
| <b>Total</b>            | <b>17,694</b> | <b>432.9</b>      | <b>18,831</b> | <b>455.5</b>      | <b>21,066</b> | <b>503.4</b>      | <b>17,979</b> | <b>425.2</b>      | <b>12,223</b> | <b>286.3</b>      | <b>12,449</b> | <b>288.5</b>      | <b>12,933</b> | <b>296.1</b>      | <b>11,932</b> | <b>270.9</b>      | <b>12,652</b> | <b>285.4</b>      | <b>12,819</b> | <b>286.7</b>      |

Data extracted from EpiSurv on 20 June 2014. Rates for cholera and toxic shellfish poisoning are <0.5 per 100,000 population so not included.

<sup>1</sup> Cases per 100,000 population calculated using mid-year population estimates.

Notes:

- All of the diseases included in the table have multiple possible transmission routes but have the potential to be transmitted via water. It is not possible here to attribute a specific number of cases associated with any specific transmission route. Multiple transmission routes are also possible. The number of cases attributable to a specific transmission route will vary by disease.
- The number of cases includes imported cases. The proportion of imported cases varies by disease.

Table 1.2 shows the number of outbreaks and associated cases recorded for enteric diseases and waterborne enteric diseases in New Zealand for the period 2004–2013.

**Table 1.2: Number of outbreaks and associated cases recorded for enteric disease and waterborne enteric disease, 2004–2013**

| Year | Waterborne enteric outbreaks <sup>1</sup> |       | All enteric outbreaks |        |
|------|---|-------|-----------------------|--------|
|      | Outbreaks                                 | Cases | Outbreaks             | Cases  |
| 2004 | 24  | 118   | 363                   | 4,623  |
| 2005 | 27  | 184   | 342                   | 2,365  |
| 2006 | 18  | 284   | 483                   | 6,171  |
| 2007 | 15  | 205   | 479                   | 7,866  |
| 2008 | 26  | 159   | 429                   | 6,311  |
| 2009 | 24  | 87    | 587                   | 10,217 |
| 2010 | 56  | 235   | 571                   | 6,153  |
| 2011 | 45  | 141   | 545                   | 6,715  |
| 2012 | 51  | 379   | 659                   | 9,489  |
| 2013 | 62  | 227   | 616                   | 6,950  |

Data extracted from EpiSurv on 20 June 2014.

<sup>1</sup> Includes outbreaks where waterborne transmission was either the primary or secondary mode of transmission reported.

Table 1.3 lists documented outbreaks in New Zealand where waterborne transmission has been implicated as a possible source of infection, from 2005 to 2013. This is an updated version of Table 1 from Ball (2007).

Note that Table 1.3 does not include all waterborne outbreaks that have occurred in New Zealand.

Apart from the Havelock North Inquiry Report, the following search methods were used:

- 1 Literature search using search terms “New Zealand” AND outbreak\* AND water\* In: Index New Zealand (INNZ), Proquest Public Health, PubMed, ScienceDirect, Scopus, Web of Science from 2006–2014
- 2 Search of New Zealand Public Health Surveillance Reports from 2004–June 2014.

Search of EpiSurv from 2005–2014 for outbreaks that reported 10 or more cases and were not household/family related.

**Table 1.3: Documented waterborne outbreaks in New Zealand, with probable links to drinking water, 2005–2016**

| Year | Incident                                  | Causal agent                 | Cases     |          | Source                 | Reference   |
|------|---|------------------------------|-----------|----------|------------------------|---|
|      |   |                              | Confirmed | Probable |                        |   |
| 2005 | Bridge Valley camp                        | <i>Campylobacter</i>         | 3         | 10       | EpiSurv                |   |
| 2005 | Hawke's Bay school camp                   | <i>Campylobacter</i>         | 6         | 34       | NZPHSR                 | <a href="https://surv.esr.cri.nz/PDF_surveillance/NZPHSR/2006/NZPHSR2006March.pdf">https://surv.esr.cri.nz/PDF_surveillance/NZPHSR/2006/NZPHSR2006March.pdf</a>   |
| 2005 | Med student camp, Canterbury              | <i>Campylobacter</i>         | 13        | 21       | EpiSurv                |   |
| 2005 | Otago bowling tournament                  | <i>Campylobacter</i>         | 8         | 13       | EpiSurv                |   |
| 2006 | Cardrona Skifield                         | Norovirus                    | 218       |          | Appl Environ Microbiol | Hewitt J, Bell D, Simmons G, et al. (2007). Gastroenteritis Outbreak Caused by Waterborne Norovirus at a New Zealand Ski Resort. Appl Environ Microbiol. 73 (24):7853–7857  |
| 2006 | School camp, Te Kuiti                     | <i>Campylobacter</i>         | 2         | 20       | EpiSurv                |   |
| 2007 | School camp, Wellington                   | Gastro – unknown cause       | 96        |          | NZPHSR                 | <a href="https://surv.esr.cri.nz/PDF_surveillance/NZPHSR/2007/NZPHSR200712Dec.pdf">https://surv.esr.cri.nz/PDF_surveillance/NZPHSR/2007/NZPHSR200712Dec.pdf</a>   |
| 2007 | Northland school                          | Gastro – viral unknown cause | 17        |          | NZPHSR                 | <a href="https://surv.esr.cri.nz/PDF_surveillance/NZPHSR/2007/NZPHSR200709Sept.pdf">https://surv.esr.cri.nz/PDF_surveillance/NZPHSR/2007/NZPHSR200709Sept.pdf</a>   |
| 2008 | Springston                                | <i>Campylobacter</i>         | 5         | 39       | EpiSurv                | <a href="http://www.3news.co.nz/Springston-residents-forced-to-boil-water-after-E-Coli-outbreak/tabid/423/articleID/49229/Default.aspx">http://www.3news.co.nz/Springston-residents-forced-to-boil-water-after-E-Coli-outbreak/tabid/423/articleID/49229/Default.aspx</a> |
| 2008 | South Canterbury youth camp               | <i>Campylobacter</i>         | 2         | 13       | EpiSurv                |   |
| 2010 | Golden Bay Holiday Park                   | Norovirus                    |           |          | Nelson Mail            | <a href="http://www.stuff.co.nz/nelson-mail/news/3655382/Lessons-from-norovirus-episode">http://www.stuff.co.nz/nelson-mail/news/3655382/Lessons-from-norovirus-episode</a>   |
| 2010 | Waiouru Commanders' Course                | <i>Campylobacter</i>         | 1         | 15       | EpiSurv                |   |
| 2011 | Runanga drinking-water supply             | <i>Campylobacter</i>         | 4         |          | NZPHSR                 | <a href="https://surv.esr.cri.nz/PDF_surveillance/NZPHSR/2012/NZPHSR2012Mar.pdf">https://surv.esr.cri.nz/PDF_surveillance/NZPHSR/2012/NZPHSR2012Mar.pdf</a>   |
| 2012 | Darfield drinking-water supply            | <i>Campylobacter</i>         | 29        | 138      | J of Water and Health  | <a href="http://www.iwaponline.com/jwh/up/wh2014155.htm">http://www.iwaponline.com/jwh/up/wh2014155.htm</a>   |
| 2012 | Hawke's Bay camping ground drinking-water | <i>Campylobacter</i>         | 28        |          | NZPHSR                 | <a href="https://surv.esr.cri.nz/PDF_surveillance/NZPHSR/2012/NZPHSR2012Sep.pdf">https://surv.esr.cri.nz/PDF_surveillance/NZPHSR/2012/NZPHSR2012Sep.pdf</a>   |
| 2012 | Cardrona Hotel and water supplies         | Norovirus                    | 48        | 5        | NZMJ                   | <a href="http://www.ncbi.nlm.nih.gov/pubmed/24362738">http://www.ncbi.nlm.nih.gov/pubmed/24362738</a>   |
| 2013 | Nelson Lakes Scout camp                   | Gastro – unknown cause       |           | 13       | EpiSurv                |   |
| 2016 | Havelock North                            | <i>Campylobacter</i>         |           | 5,500    | DIA                    | <a href="https://www.dia.govt.nz/Government-Inquiry-into-Havelock-North-Drinking-Water">https://www.dia.govt.nz/Government-Inquiry-into-Havelock-North-Drinking-Water</a>   |



## Relevant terminology

**Outbreak** is a term used in **epidemiology** to describe an occurrence of disease greater than would otherwise be expected in a particular time and place. It may affect a small and localised group or impact upon thousands of people across an entire continent. Two linked events of a rare infectious disease may be sufficient to constitute an outbreak. The outbreak detection level is determined by epidemiologists on the basis of their knowledge of the disease under consideration. Outbreaks may also refer to **epidemics**, which affect a region in a country or a group of countries, or **pandemics**, which describe global disease outbreaks.

**The disease incidence rate** is usually reported as the number of cases per 100,000 people per annum. Sometimes **disease burden** is used (DALY – see section 1.6.2); this incorporates the duration of the illness and its consequences and gives a better idea of how serious the outbreak may be. For example, a norovirus infection may last one or two days, but cryptosporidiosis may persist for more than two weeks.

- 1 **Sporadic disease:** A *sporadic disease* is one that occurs only occasionally in a population (ie, normally absent and unpredictable).
- 2 **Endemic disease:** An *endemic disease* is one that is always present in a population, with a predictable resolution or in a predictable way, with no external inputs needed.
- 3 **Epidemic disease:** An *epidemic disease* is a disease that many people acquire over a short period (ie, with suddenly increasing incidence).

Figure 1.1, amended from Frost et al 2003 by Craun et al 2004, illustrates the difference between outbreaks of disease (epidemic) and endemic or sporadic disease occurrences. Figure 1.1 shows there will be an underlying disease incidence below the reporting level.

**Figure 1.1: Epidemic versus endemic/sporadic disease**

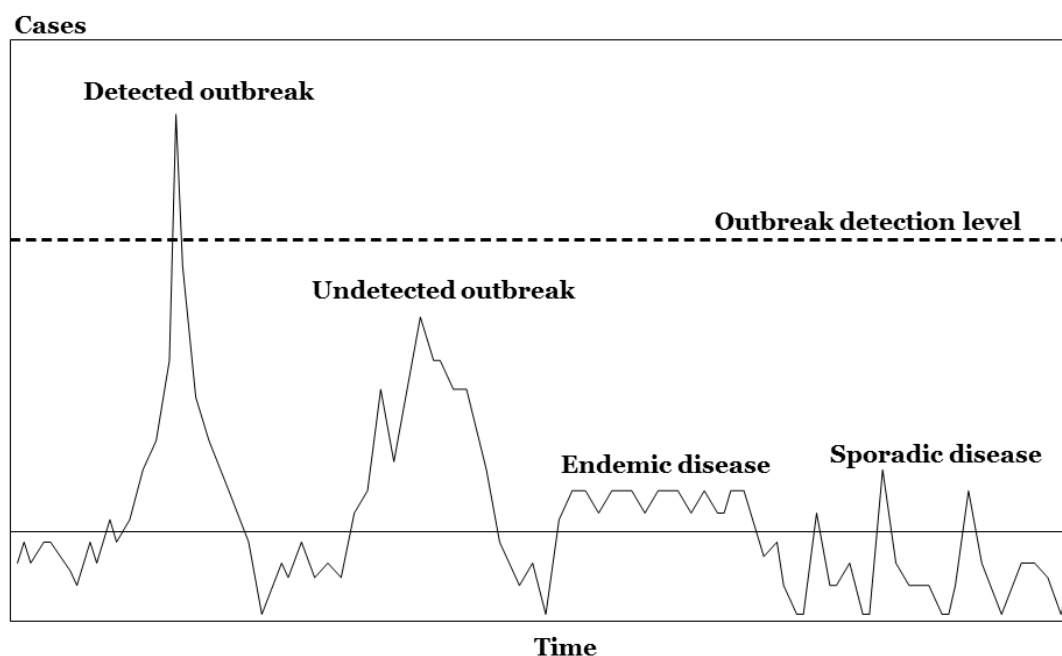

## 1.1.4 The cost of providing potable drinking-water

Water that complies with the DWSNZ should be safe to drink. Since 1995 a number of attempts have been made to determine how much it will cost to upgrade all New Zealand drinking-water supplies to enable them to comply with the DWSNZ.

Two classes of expenditure must be considered:

- CAPEX – the capital expenditure required to provide treatment facilities that are capable of delivering compliant water
- OPEX – the cost of operating the water supply system and monitoring its performance. Note that this should (but doesn't always!) include maintenance.

Prior to 2000, Local Government NZ (LGNZ) made attempts to estimate these costs for local authority operated supplies, but found it difficult to obtain adequate data.

Prior to the passage of the Health (Drinking Water) Amendment Act in 2007 the Ministry of Health sponsored two major studies on the costs of providing treatment plants capable of providing potable drinking-water:

- in 2001 Beca Steven estimated the costs as \$269.50 to \$290.40 million (Beca 2001)
- in 2004 Roseveare and Yeabsley of OMS (OMS 2004) estimated the:
  - Capex as \$329.8 million
  - Opex as \$4.3 million per year.

The authors noted the wide error band of the estimates. The uncertainties arise from:

- the unknown number of small water supplies that are not operated by local authorities and are not on the Register. Some 1500 of these were registered, but many more were thought to exist
- the variable standard of the existing facilities. Although many were well-maintained and serviceable, a significant number were inadequate or very poorly maintained and would be expensive to bring up to a serviceable standard.

It is interesting to note that the US 1996 SDWA Amendments mandated that information about treatment technology performance and affordability be developed for small systems (<10,000 population). Affordability criteria (for the annual cost of drinking-water) are based on a threshold of 2.5 percent of the median household income (quoted from USEPA 2003).

The OECD (2011) notes that the full magnitude of the benefits of water services is seldom considered for a number of reasons. Non-economic benefits that are difficult to quantify but that are of high value to the concerned individuals and society, ie, non-use values, dignity, social status, cleanliness and overall wellbeing, are frequently under-estimated.

## 1.1.5 The benefits of potable drinking-water supplies

OMS (2004) estimated the direct annual benefit of illness avoidance by controlling waterborne disease in New Zealand at \$13 million to \$37 million a year on the basis of the notified waterborne enteric disease data of 18,000 cases in 1999 (the last full year of data available at the time) (assessed as costs foregone).

The data from 1986 to 2004 were later systematically reviewed by Ball of ESR in 2006. Ball concluded that the number of cases per year was at least 34,000, which would give a much higher benefit than that calculated by OMS.

OMS noted that an uncertain level of unknown additional benefits arose from:

- protecting the sanctity of the public drinking-water infrastructure (analogous to the sanctity of the blood bank)
- equality of access to a basic human right/need
- maintaining the 'New Zealand brand' in terms of our clean, green and secure environment in the eyes of the overseas community for food exports, and as a destination for immigration and tourism
- the benefits of the interventions included time-savings associated with better access to water and sanitation facilities, the gain in productive time due to less time spent being ill, health sector and patients' costs saved due to less treatment of diarrhoeal diseases, and the value of prevented deaths.

**Table 1.4: Economic benefits arising from water and sanitation improvements**

| <b>Beneficiary</b>                  | <b>Direct economic benefits of avoiding diarrhoeal disease</b>   | <b>Indirect economic benefits related to health improvement</b>   | <b>Non-health benefits related to water and sanitation improvement</b>  |
|-------------------------------------|--|---|---|
| Health sector                       | Less expenditure on treatment of diarrhoeal disease  | Value of fewer health workers falling sick with diarrhoea   | More efficiently managed water resources and effects on vector bionomics  |
| Patients                            | Less expenditure on treatment of diarrhoeal disease and fewer related costs<br>Less expenditure on transport in seeking treatment<br>Less time lost in seeking treatment | Value of avoided days lost at work or at school<br>Value of avoided time lost of parent or carer of sick children<br>Value of loss of death avoided | More efficiently managed water resources and effects on vector bionomics  |
| Consumers                           |  |   | Time savings related to water collection or accessing sanitary facilities<br>Labour saving devices in the household<br>Switch away from more expensive water sources<br>Property value rise<br>Leisure activities and non-use value |
| Agricultural and industrial sectors | Less expenditure on treatment of employees with diarrhoeal disease   | Less impact on productivity of ill-health of workers  | Benefits to agriculture and industry of improved water supply, more efficient management of water resources – time saving or income generating technologies and land use changes  |

Hutton and Haller (2004) summarised for WHO the benefits of potable drinking-water supplies, see Table 1.4, but noted that the intangible and unforeseen benefits often outweigh the direct benefits of disease reduction.

In another New Zealand study the Wellington Regional Council has estimated the cost of waterborne illness per affected household to be \$5,000 (WRC 1998), based on a household size of three persons, and period of illness of 2.5 weeks. Using Hamilton as an example (160,000 people), the cost of illness of a cryptosporidiosis outbreak in drinking-water could be estimated at \$109 million comprising \$80 million in cost of illness affecting 30 percent of the city and \$28.8 million due to a 0.025 percent mortality rate amongst those infected (12 people). Applying US figures, the cost of averting behaviour (hauling safe water, boiling water and/or purchasing bottled water) as a result of an outbreak of waterborne disease, again relating to Hamilton, is estimated at \$14.8 to \$46.8 million per month (Harrington et al 1985) who surveyed a community in Pennsylvania, USA which experienced a giardiasis outbreak in 1983). Averting behaviour expenditures were estimated for each household at US\$153 to \$483 per month (converted to NZ\$278 to \$878 at NZ\$/US\$0.55, for 53,300 households in Hamilton).

A further saving arises because consumers do not need to install any supplementary treatment device such as point-of-use (POU) equipment in any New Zealand water supply that complies with the DWSNZ and has a good Grading. Consumers that choose to install such equipment need to be careful that they do not introduce health concerns through improper use or maintenance, such as allowing bacteria to grow in the equipment that removes chlorine. See Chapter 19: Small, Individual and Roof Water Supplies, section 19.3.4 for further information.

Further savings arise because purchase of bottled water is unnecessary. It should also be noted that New Zealanders spent \$26,000,000 on bottled water in 2004, including coolers (G Hall, Corporate Water Brands, pers comm). At least some of this can be taken as the cost of a lack of confidence in public water supplies. Tap water quality in Tokyo is strictly regulated and advanced water treatment techniques such as ozonation have been widely introduced, with tap water quality attaining the highest level in the world. However, a 2013 consumer report indicated that only 49% of people in Tokyo drank tap water. Surveys have revealed a lack of knowledge about tap water regulation, with water suppliers needing to improve communication with citizens about safety and selection of tap water as drinking water.

LECG (2010) concluded a net economic benefit to New Zealand of \$134 million would be achieved by requiring large water suppliers to comply with both the bacteriological and protozoal determinands; a net economic benefit is also expected if medium supplies comply with both. The economic benefits to New Zealand for minor, small and neighbourhood supplies complying with both would need to be considered on a case by case basis. The cost of compliance was estimated by CH2M Beca (2010).

Dupont and Jahan (2012) examined factors that explained consumer spending on tap water substitutes using information from a national survey undertaken with a representative set of Canadian respondents. They developed a model to predict the percentage of households that undertook such spending for the purpose of reducing perceived health risks from tap water consumption. Using results from the model they estimated the magnitude of defensive expenditures to be over half a billion dollars (2010 US\$) per year for Canada, as a whole. This is equivalent to approximately \$48 per household per year or about \$19 per person per year. Residents of Ontario, the province in which an *Escherichia coli* incident took place in 2000, had the highest willingness-to-pay of approximately \$60 per household per year.

## Darfield

The Canterbury town of Darfield (population 1790) experienced an outbreak of campylobacteriosis in August 2012 where it is estimated that 413 people became ill due to faulty chlorination of the water supply. A sensitivity analysis based on the lowest and highest plausible estimates of campylobacteriosis cases identified ranges of total monetised costs of \$308,592–\$536,401, 871 days off school and 0.93–1.31 DALYs. From: Sapere Research (2013).

## Havelock North

A campylobacter outbreak occurred in Havelock North in 2016 (see Table 1.3). The MoH commissioned a report to determine the costs of outbreak (Sapere 2017).

Costs were separated into six broad groupings: local government, the business sector, central government, non-governmental organisations (NGOs), health/illness-related costs, and households. In addition, costs were distinguished by the following stages:

- investigation/diagnosis refers to the sourcing and confirmation of the outbreak (eg, expert reports, testing, planning and setting up response teams)
- reaction relates to costs that arose once the contamination was confirmed (eg, provision of bottled water, communications and information provision and co-ordination costs, welfare teams)
- remedial covers costs related to actions to 'make right' the water supply (treatment, engineering costs, further testing, etc)
- consequential describes costs that arise because of the outbreak (eg, filtered water stations, safeguards, and inquiry related costs)
- residual are costs that are ongoing such as monitoring, testing, rates rebates, information campaigns, and costs to respond to ongoing inquiries as to the safety of the water.

Total economic costs associated with the outbreak were estimated to be \$21,029,288. The vast majority of costs relate to household inconvenience due to having to boil water, buy bottled water, and taking time off from normal activities during the outbreak. This is a function of the large number of households affected (5,088) and the relatively high costs per household of around \$2,440.

An ESR presentation in 2019 stated that:

- scientists believe that the *Campylobacter* strains that caused the Havelock North outbreak were extremely virulent
- it is possible that people only needed to ingest 10 *Campylobacter* cells to become infected
- sheep defecate 865 g of faeces per day
- there are 3.3 million *Campylobacter* per gram of sheep faeces
- to contaminate Havelock North's water supply for one day only 70 g of faeces would need to have entered the drinking water reticulation system
- Havelock North residents would only have needed to drink 300 mL of water per day to become ill.

# 1.2 Ministry of Health public health protection strategy for drinking-water 1993–1995

## 1.2.1 Strategy development

The purpose of the Ministry of Health (MoH) strategy for drinking-water, formally adopted by the Director-General of Health in 1995, was to develop and apply the necessary tools for the implementation of the policy for drinking-water management.

From 1993 to 1995 the MoH developed an initial strategy to protect the public health safety of drinking-water. The goal of the MoH drinking-water policy was to achieve a high standard of drinking-water quality and management in New Zealand by promoting the understanding and application of the principles of public health safety by drinking-water suppliers and the general public. The development and implementation of this strategy are outlined below.

To develop its public health protection strategy for drinking-water, the MoH developed:

- goals and objectives for public health protection of drinking-water
- assessed whether the desired goals and objectives were realistic and achievable
- assessed the tools available for implementing the strategy:
  - which tools are currently in use?
  - what new tools are required?
  - would they work?
  - what were their strengths and weaknesses?
  - whether their performance could be enhanced by designing them to work synergistically
  - whether there was statutory authorisation for their use
- planned an integrated strategy by:
  - deciding which tools were needed to provide adequate protection for drinking-water quality
  - ascertaining how to design the tools to ensure that they reinforced one another in use
  - preparing a schedule of objectives for developing and implementing the tools.

The programme was designed to get the already-existing tools into operation as soon as possible and concurrently to:

- develop an overall strategy and a notional timetable for implementation
- redesign the already-existing tools to work better together to achieve the desired goals
- develop new tools as required.

## 1.2.2 Outline of the strategy

The Ministry of Health's drinking-water strategy from 1993 to 1995 involved:

- 1 development of performance standards on all aspects of management of drinking-water quality
- 2 development of standards of competence for health officers and Medical Officers of Health working with drinking-water in order to achieve consistent national standards
- 3 development and application of an integrated set of tools for promoting the provision of potable, wholesome drinking-water supplies
- 4 provision of information to the public on public health issues concerning drinking-water and the quality of community drinking-water supplies
- 5 promotion of public health issues concerning drinking-water to the public
- 6 promotion of self-management by the water supply industry
- 7 promotion of the use of quality assurance management techniques by water supply authorities, including adequate documentation of management procedures, monitoring procedures and contingency plans
- 8 provision of the electronic database Water Information, New Zealand (WINZ) to provide for the recording of all aspects of drinking-water supply performance and enable the assessment and reporting of improvement in performance
- 9 preparing for consultation on legislation to strengthen the implementation of the strategy
- 10 implementation of the overall strategy by a 'ratchet' process that improves performance in 'digestible' steps in one area and to facilitate advance in another area where progress had previously been difficult.

## 1.2.3 Planned milestones

- Obtain a clear understanding, by the end of 1996, of who will take responsibility for each of the various categories of community drinking-water supplies.
- Achieve implementation, by the end of 1997, of a programme of self-monitoring by the water suppliers, audited by health agencies, in 95 percent of all community drinking-water supplies.
- Achieve informed community discussion and decision-making on public health safety issues on drinking-water by the end of 1997.
- Achieve potable drinking-water in:
  - 95 percent of all large community drinking-water supplies (large = over 500 population supplied) by the end of 1996
  - 90 percent of all small community drinking-water supplies (small = 25 to 500 population supplied) by the end of 1998.

These targets are now for population groups rather than supplies.



## 1.2.4 Desired outcomes

- Adequate and effective monitoring of the quality of drinking-water supplies by suppliers.
- Sufficient knowledge and awareness of public health issues for the public to enable their effective participation in decision-making about public health issues relating to community drinking-water supplies.
- Competent health officers assessing the quality of water supplies to a consistent standard throughout the country.
- Improved public health safety standards for community and private drinking-water supplies.
- An effective statutory basis for the public health protection of drinking-water supplies.

## 1.2.5 Promotion of awareness of public health issues related to drinking-water

This was achieved by publication of reports on the public health grading of community drinking-water supplies and on the presence of determinands of public health concern found in the supplies (Priority 1 and 2 determinands) commenced in the *Register of Community Drinking-water Supplies in New Zealand* in 1993 and immediately attracted media attention.

Copies of the *Drinking-water Standards for New Zealand 1995*, the *Guidelines for Drinking-water Quality Management in New Zealand 1995* and the *Register of Community Drinking-water Supplies in New Zealand* (which was originally published approximately twice a year), were placed in every public library in the country to ensure that authoritative information on drinking-water quality management was freely available.

## 1.2.6 Outputs achieved by 1995

A number of the planned outputs were achieved or were well advanced in the first three years.

- Publication of the public health grading, together with drinking-water sources, of treatment plants and distribution zones commenced at the end of 1993.
- The 1984 *Drinking-water Standards for New Zealand* were revised by the end of 1994 and published in 1995.
- Most large community drinking-water supply treatment plants had been graded by the end of 1994.
- Standards for drinking-water data and data transfer were in place by mid-1994.
- New regulations for drinking-water quality management had not been achieved by 1995, but a discussion paper on the need for drinking-water legislation was in preparation.

# 1.3 Strategy development

## 1995–2000

### 1.3.1 Consultation

In 1995 a public discussion paper<sup>5</sup> on the introduction of the Ministry's 1994 policy was published and public meetings on it were held in the four main centres in association with the NZWWA.

Based on the feedback from the 1995 paper a further discussion paper<sup>6</sup> was produced in 1998 which reviewed all New Zealand legislation relating to drinking-water and outlined options for consolidating the legislation. This underwent consultation similar to that held on the 1995 paper, with similar results.

<sup>5</sup> Drinking-water public health issues – a public discussion paper. MoH, Wellington, March 1995. 67 submissions were received representing the views of 101 agencies and groups. There was unanimous agreement that:

- 1.01 safe drinking-water is a key requirement for public health
- 1.02 all persons should have the right to expect that any water which they draw from a tap was safe to drink unless they were specifically informed to the contrary. This was considered especially important in premises handling food and to be particularly important for tourism, and travellers. It was considered that there was a need for signs in hotels, camps, farmstays etc where the water does not meet the Standards
- 1.03 the legislation relating to drinking-water is outdated, fragmented, inadequate and in need of revision, integration and cross-referencing. Over 36 Acts and Regulations are involved. In these, reference is made to 'acceptable', 'pure', 'wholesome', 'potable', or 'safe', water, etc; what these terms mean is rarely defined. All submissions on this subject recommended that the definitions of these terms should be standardised throughout the legislation
- 1.04 any legislative revision should remove gaps, produce consistency and remove conflict between the various Acts, Regulations and Bylaws which relate or refer to drinking-water quality, especially the Local Government Act 1974, the Rating Powers Act 1988, the Health Act 1956, the Resource Management Act 1991, the Water Supplies Protection Regulations 1961, the Building Act 1991 and the model Bylaws
- 1.05 compliance mechanisms and penalties should be effective and of equivalent severity to those in the Resource Management Act 1991 and the Health and Safety in Employment Act 1992
- 1.06 the Ministry of Health should be the lead organisation in the national management of drinking-water quality, with territorial authorities having a key role in the enhancement of drinking-water quality control
- 1.07 the Ministry of Health should be statutorily empowered to promulgate drinking-water standards
- 1.08 the Ministry of Health should be statutorily empowered to carry out the public health grading of drinking-water supplies
- 1.09 the respective roles, relationships and responsibilities of the various agencies and statutory officers involved in drinking-water quality management (principally the designated officers of the Ministry of Health and the TA's officers concerned with each of the supply, regulation and planning functions) need to be more clearly defined in the legislation. This includes defining the responsibility for each of water supply provision, monitoring, surveillance, audit etc
- 1.10 the public has a right to know about the quality and safety of drinking-water supplies and all information about these should be publicly available.

<sup>6</sup> Review of the Water Supplies Protection Regulations 1961 (Review of Regulations made under the Health Act 1956) – a discussion document. MoH (Wellington), February 1998.

## 1.3.2 Inclusion of protozoa in the DWSNZ

Prior to 1990, the focus of waterborne disease prevention was on bacterial pathogens and much work was in progress to determine whether faecal coliforms (thermotolerant coliforms, enterococci or *Clostridium* spp) were the best indicators of the presence of faecal contamination. Work was also in progress to distinguish between organisms of human and animal origin because it was thought that animal organisms would not be pathogenic to humans. In the early 1990s it became evident that *Giardia* was a significant emergent waterborne disease in New Zealand. Consequently public health management of *Giardia* and *Cryptosporidium* was addressed in the 1995 and 2000 DWSNZ. Because of the difficulty of monitoring these protozoa directly, control in the 1995 and 2000 standards was by specifying turbidity (as a surrogate for particle counts) and filter pore size.

## 1.3.3 Human resource development

Assessment of the results of the first round of drinking-water supply grading carried out after public health grading was introduced in 1993 showed that the level of competence of the DHB health protection officers in assessing the performance of drinking-water supplies was very uneven. For effective administration of drinking-water quality management legislation it would be essential that the assessment process is carried out to a consistently high level of competence.

To prepare for the needs of the proposed legislation, the Ministry sponsored the establishment of a NZQA diploma in drinking-water assessment to provide appropriate training for HPOs in drinking-water supply management and operation, complemented by training in the legal requirements relating to their water supply duties. In addition, arrangements were made for the water HPOs to obtain IANZ accreditation to ISO/IEC 17020 specifications for inspection and assessment. Drinking-water assessment units (DWAUs) were set up in the participating DHBs. These were accredited by IANZ as inspection bodies with the officers who were to be appointed as DWAs after the legislation was promulgated, being designated as approved signatories for the DWAUs and authorised to use the IANZ logo on reports on the water supply assessments that they had been accredited to perform.

## 1.3.4 DWSNZ 2000

The 1995 DWSNZ were revised and finally re-issued in 2000 with the assistance of the Expert Committee on Drinking-water Quality. The main changes involved:

- replacing faecal coliforms as the indicator of faecal contamination to *E. coli*
- including *Cryptosporidium* in the protozoal compliance section. In the decade after 1995 the understanding of the public health importance of protozoa in drinking-water increased rapidly and the importance of *Cryptosporidium* as a major new waterborne pathogen that was resistant to conventional disinfection procedures or practices rapidly overtook that of *Giardia*. The scientific understanding of *Cryptosporidium* management advanced with extreme rapidity and by 2000 it became necessary to update the 1995 DWSNZ to incorporate the new knowledge. *Cryptosporidium* was selected as the representative protozoan because it is the most difficult to control in drinking-water

- introducing monitoring requirements for ozone and chlorine dioxide disinfection to meet the protozoal requirements, and removing the C.t tables for *Giardia* inactivation using chlorine
- the use of Bayesian statistics to guide the derivation of monitoring frequencies and acceptable transgression rates
- updating the MAVs based in the 1998 revision of the 2nd edition of the WHO *Guidelines for Drinking-water Quality*
- including PMAVs for cyanotoxins.

## 1.4 Strategy development 2000–2005

### 1.4.1 Consultation

In 2000 consultation was held in conjunction with NZWWA on the procedures that had been developed by ESR for the Ministry on Public Health Risk Management Plans (PHRMPs – now known as Water Safety Plans) for drinking-water supplies and on the need to update the Public Health Grading protocols. The philosophy behind the WSP was generally accepted. Proposals were made to include the WSP as part of the grading process, but it was decided to hold this over until there was more experience with the use of WSPs.

### 1.4.2 Water safety plans

The limitations of the historical approach to drinking-water quality management by the quality control (QC) procedure of assessing compliance with a product quality standard (the DWSNZ) had become evident by 2000.

Although the QC approach established whether the drinking-water quality targets had been met, this occurred only after the event. Also, because bacterial tests then took two days to complete, identification of a contamination event did not occur until two days after the event. The use of a water safety plan (WSP) for a water supply was seen as a way of introducing quality assurance (QA) procedures into drinking-water quality management. The publication of the NZ Guidelines on the Preparation of PHRMPs (Ministry of Health 2001)<sup>7</sup> was followed by the publication of Chapter 4 on Water Safety Plans in the WHO *Guidelines on Drinking-water Quality* (3rd edition, 2004). Following the WHO publication the use of PHRMPs for drinking-water supplies (called water safety plans by WHO) has become an internationally accepted procedure. WHO has used New Zealand DWAs to provide training in water safety plans to the Pacific Island countries.

<sup>7</sup> See *New Zealand Drinking-water Safety Plan Framework* – Ministry of Health (2018).

The stages in the development of a WSP are:

- identification of what is intended to be achieved (the target, eg, compliance with the DWSNZ)
- identification of the factors that could impede the achievement of the target (the risks). This includes identification of the financial and technical resources required to achieve the target, both the set-up and ongoing operational requirements
- identification of the ways in which the risks could be overcome (managed). This includes identification of the necessary financial and technical resources
- identification of the relative magnitude of the risks and ranking of the priorities for dealing with the risks, taking into account their importance and the relative ease of management
- development of contingency plans for managing unusual but critical perturbations of normal operation (eg, floods, droughts, power cuts, accidents to key personnel)
- completion of a schedule for managing the risks (a three- to five-year timetable)
- implement the WSP
- monitor, and review the WSP implementation performance, revise if necessary.

The water safety process can form the basis of a complete drinking-water quality management programme.

The steps along the pathway of using the WSP as the basis of a programme for achieving the target of a supply that delivers an adequate volume of water that is safe to drink are:

- 1 completion of a WSP for the supply
- 2 optimisation of the operation and management of the existing supply process
- 3 establishment of a programme for monitoring the performance of the water supply system to verify progress
- 4 preparation of an improvement schedule for the supply, based on the information in the WSP
- 5 preparation of a design report for upgrading the supply, if the target cannot be achieved (an engineer's report).

### 1.4.3 Legislative development

Building on the recommendations from the 1995 and 1998 public discussions on proposals for strengthening the drinking-water quality management sections of the Health Act 1956, Cabinet instructed the Ministry of Health in November 2000 to prepare a Health Act Amendment Bill which would provide a statutory framework for the non-regulatory interventions that were currently operating. The amendment was to strengthen and improve the existing legislation by:

- 1 providing assurance that a sector, with assets measured in the billions of dollars and which is fundamental to economic development (including the tourism sector), would be adequately managed
- 2 assisting local government to discharge their statutory duty “to improve, promote and protect public health”
- 3 placing duties on drinking-water suppliers to take all practicable steps<sup>8</sup> to comply with the drinking-water standards (and various other duties and powers ancillary to that)
- 4 providing a statutory framework for the promulgation of drinking-water standards
- 5 putting duties on the general public not to contaminate drinking-water supplies
- 6 requiring drinking-water suppliers to introduce and implement water safety plans
- 7 providing for officers designated by the Ministry to act as assessors to verify:
  - compliance with the DWSNZ
  - the standard and implementation of water safety plans
  - the competence of water supply staff carrying out process and field analyses
- 8 requiring designated assessors to have their competence accredited by an internationally recognised conformance accreditation agency
- 9 providing for appropriate record-keeping and publication of information about the compliance of the supply with the Act.

## 1.4.4 Development of the DWSNZ 2005

Subsections 1.4.4.1 to 1.4.4.5 discuss the main changes from the 2000 DWSNZ. The DWSNZ 2005 maintained the two principal components:

- the water quality specification (standard), which defined the Maximum Acceptable Values (MAVs) at which the risk of disease from drinking the water is negligible. A new concept, operating requirements, was introduced where monitoring of a MAV was impracticable
- the compliance specifications, which define the checks (and their frequencies) that are to be taken to demonstrate compliance with the DWSNZ.

<sup>8</sup> All practicable steps, in relation to the achievement of any particular result, means all steps to achieve that result that it is reasonably practicable to take in the circumstances, having regard to the:

- a) nature and severity of the harm that may be suffered if the result is not achieved, and
- b) current state of knowledge about the likelihood that harm of that nature and severity will be suffered if the result is not achieved, and
- c) current state of knowledge about harm of that nature, and
- d) current state of knowledge about the means available to achieve that result, and about the likely efficacy of each, and availability and cost of each of those means.

#### 1.4.4.1 Introduction of the log credit approach

Because the methods available for identifying *Cryptosporidium* were not suitable for routine monitoring, and there appeared to be no suitable indicator organisms, it became necessary to improve the surrogate methods used to manage the public health risk. This was done by improving the performance of treatment processes in removing or inactivating *Cryptosporidium* oocysts. This stimulated the introduction of quality assurance methodology for drinking-water supply operational management, which culminated in the development of Public Health Risk Management Plans (now known as Water Safety Plans).

The risk of infection from drinking-water contaminated by waterborne protozoa is affected by the:

- concentration of *Cryptosporidium* oocysts or other protozoal cysts in the raw water
- extent to which (oo)cysts are inactivated or removed by the treatment processes.

To take account of the additive effect of a series of treatment processes on the removal of protozoa, log credits are used, *Cryptosporidium* being used as the reference organism. The log credit for a treatment process is the logarithm of the percentage of the protozoa the process can remove or inactivate. The cumulative effect of successive treatment processes can be calculated by adding the log credits of all the qualifying processes in use. The cumulative effects cannot be added when the removal is expressed as a percentage.

#### 1.4.4.2 UV disinfection

Much work was done internationally on improving the understanding of the use of UV irradiation for inactivating *Cryptosporidium*. Originally UV was thought to be ineffective, because the oocysts appeared visually to be unchanged by exposure to UV. Development of means of measuring the extent of inactivation of the oocysts and measuring their infectiousness, combined with genotyping led to a significant increase in the understanding of control methods and demonstrated that UV was much more effective than initially thought.

UV will also control bacteria, but, like ozone, leaves no disinfectant residual.

#### 1.4.4.3 Cyanobacteria

Prior to 2000, cyanobacteria were not considered a major problem in New Zealand surface waters. Outbreaks were few and far between and confined mainly to standing waters such as ponds and lakes. Since about 2000 the situation changed and cyanobacteria became much more prevalent, including a major outbreak in the Waikato River. Also it was realised that the public health concern was not the cyanobacteria themselves but the cyanotoxins that they produced.



Cyanobacteria produce a range of toxins similar to those found in toxic shellfish. Thus the control measures had to be based on the management of the toxins at least as much as the organisms. In addition to the planktonic cyanobacteria in the water mass, pads of benthic cyanobacteria have also become a problem and have caused a number of dog deaths. It was considered prudent to develop management techniques including action levels for cyanobacteria and cyanotoxins in drinking and recreational waters.

#### 1.4.4.4 Small water supplies

Before 2005 the development of drinking-water standards was largely targeted to the management of water supplies serving populations greater than 500. Annual reviews of drinking-water quality have shown that the smaller supplies consistently perform less well than larger supplies. Also, the costs of monitoring water quality are relatively small per head of population when spread over a large community, but excessive when spread over a small number of people. Between 2000 and 2005 major consultations and discussions were held to try to improve the situation for small supplies, so drinking water standards based on risk management planning rather than formal compliance with water quality standards were developed for use in the 2005 DWSNZ.

#### 1.4.4.5 Tankered drinking-water

In small unreticulated drinking-water supplies, especially ones in which roof water provides a significant proportion of the available water, it is almost inevitable that some portion of the water will be provided by tankered supplies.

It was considered necessary to provide for the management of the quality of this tankered drinking-water because there was anecdotal evidence that some tankered water deliveries were of dubious quality, due to use of dirty tankers or filling them from other than town supply hydrants.

### 1.4.5 Development of the drinking-water assistance programme

By 2003 it was evident from the annual review of drinking-water quality management that the improvement in water supplies due to the implementation of the 1993 policies had reached the point of diminishing returns and had reached a plateau. Larger supplies were substantially complying with the DWSNZ, but a number of the smaller supplies did not comply.

To ascertain the reasons for the non-performance of the smaller supplies, the Ministry sponsored surveys of some 120 smaller supplies to ascertain what these suppliers considered to be the major impediments to the improvement of their performance.<sup>9</sup> This was supplemented by sixteen regional public meetings from Whangarei to

<sup>9</sup> NZWWA/NZWRF. 2002. New Zealand Small Water Systems Survey (Report to the MoH) Wellington.



Invercargill.<sup>10</sup> The principal impediment to compliance with the proposed legislation was seen as lack of technical training of the operators and the availability of technical information. This was considered by the small suppliers to be even more important than the costs that would be incurred in complying. Many of these suppliers did not know how to effectively manage the use of the facilities that they already had.

During the government's Infrastructure Stocktake (aimed at identifying the key utilities required to underpin the economic well-being of New Zealanders), drinking-water and waste management were identified as key utilities.

The need to improve the performance management of small supplies had been demonstrated by their poor performance recorded in the annual reviews of drinking water quality and by the responses of small communities to the consultation rounds. By 2000 sufficient information was being gathered on the management needs of small communities to enable the management needs of the 20 percent of the population serviced by small drinking-water supplies to be addressed.

Planning to meet the needs for provision of technical information and training for operators of small supplies together with financial assistance where this could be demonstrated to be necessary commenced in 2001. As a result of the government's infrastructure stocktake, funding for assistance to underperforming drinking-water supplies was made available in the 2005 Budget.

## 1.5 Operational development of the drinking-water management programme 2005–2009

### 1.5.1 The Drinking-water Assistance Programme, DWAP

To meet both the technical and financial needs of the small suppliers that had been identified by consultation and planning in 2000–2005, the Drinking-water Assistance Programme (DWAP) was designed to have two complementary components: the Technical Assistance Programme and the Drinking-water Subsidy Scheme. Public health units have been appointed to implement the DWAP on behalf of the Ministry and is for water supplies serving between 25–5,000 people.

<sup>10</sup> ESR. 2004. Report on regional consultation meetings for smaller and rural water supplies; FW0474. Meetings were held in Whangarei, Tauranga, Hamilton, Taupo, Palmerston North, New Plymouth, Gisborne, Napier, Masterton, Queenstown, Greymouth, Nelson, Invercargill, Balclutha, Timaru, Kaikoura.

## a) The Technical Assistance Programme

The first component of the DWAP is a Technical Assistance Programme that provides advice and technical assistance to drinking-water suppliers. The Technical Assistance Programme assists suppliers to evaluate their supply, produce a WSP and optimise the performance of their existing facilities. Should the supply be incapable of complying with the DWSNZ after its performance has been optimised, the Technical Assistance Programme can assist with assessing the capital works needed to upgrade the supply so that it can meet its performance targets. The Technical Assistance Programme is available to any supply under 5,000 people.

## b) The Subsidy Scheme

The Technical Assistance Programme is complemented by a Subsidy Scheme that administers the funds available to the DWAP for capital assistance. Eligibility and priority criteria were revised in 2010. Applications for subsidy are processed through the Sanitary Works Technical Advisory Committee (SAWTAC).

Applicants for the Subsidy Scheme must meet the criteria set out in *Applying for a Drinking-water Subsidy: Guidelines for applicants and district health board public health units* available on the Ministry of Health's website. For the Subsidy Scheme:

- \$10 million is available for allocation each year until 2015
- the scheme will pay up to 85 percent of costs (previously it was 95 percent)
- only those communities with a Deprivation Index of 7 and above are eligible
- the criteria clarify that asset replacement, maintenance, land purchase and applications from city councils are not eligible for subsidies
- an engineering review is required for subsidy applications that exceed \$1,000 subsidy per person for a water supply scheme.

Applications must be submitted to the Ministry of Health no later than 5 pm on 28 February of each year until 2015. Further information is available from public health units and on the Ministry of Health's website.

## 1.5.2 Legislation: The Health (Drinking Water) Amendment Act 2007 (Part 2a of the Health Act 1956 – the Act)

The Health (Drinking Water) Amendment Bill that was passed in 2007 contained a number of changes from the original proposals submitted to Cabinet in 2000, which are listed in section 1.2.2. These changes were either authorised by Cabinet before the Bill went to Parliament, or were recommended by the Select Committee. These included:

- tankers, ports and airports to be classified as drinking-water suppliers
- changes to the criteria for establishing whether the 'all practicable steps' criterion had been met
- addition of the new category of Rural Agricultural Drinking-water Supply to the list of categories of water supplies
- the requirement to assess whether an action required under the Act is affordable as part of the procedure for deciding whether all practicable steps have been taken to achieve a result required.

### 1.5.3 The 2008 revision of DWSNZ 2005

The amendment to the Act necessitated a number of changes to the DWSNZ 2005, including the need to develop a section on Rural Agricultural Drinking-water Supplies. The changes were published in the 2008 revision of the DWSNZ 2005 and became available as the Rural Agricultural Drinking-water Supply Guideline (Ministry of Health 2015). The introduction of the WSPs necessitated a number of minor adjustments to ensure compatibility with the Act.

Although the DWSNZ 2005 had been the result of a consensus among members of the Expert Committee on Drinking-water Quality, set up to advise the Ministry of Health, several submissions from small water suppliers necessitated major rewrite of section 10 (small supplies).

Water suppliers were invited to comment on the 2005 DWSNZ, resulting in the clarification of the other sections, particularly related to procedural matters in the protozoal compliance section. The opportunity was also taken to update the maximum acceptable value (MAV) tables based on the latest World Health Organization (WHO) information. All water suppliers that had commented on the 2005 DWSNZ were asked to confirm that their concerns had been addressed in the draft revision.

### 1.5.4 Tankered drinking-water supplies

Standards have been developed for use with different types of source water for tankered supplies. For operational guidance, the Tankered Drinking Water Carrier's Association has prepared *Guidelines for the Safe Carriage and Delivery of Drinking-water*. The initial draft was produced in conjunction with the New Zealand Water and Wastes Association, as a Code of Practice. The final version was published by the Ministry in 2008, as Guidelines (Ministry of Health 2008).

## 1.5.5 Development of specifications for Rural Agricultural Drinking-water Supplies (RADWS)

The DWSNZ 2005 revised (2008) are prescriptive standards developed to ensure potable drinking-water for the population's water supplies. Many of the criteria used in these standards are population-based and are appropriate for use in homogeneous reticulated communities such as towns where the principal purpose of the water supply is for drinking. However they do not meet the needs of the rural situation where the purpose of the water supply is more heterogeneous.

In rural communities a large proportion of the water supply may not be intended for drinking. The water may be used mainly for irrigation or stock watering. Treating all of this water to comply with the drinking-water standards may be pointless and unnecessarily costly. For this reason it was proposed that a Rural Agricultural category (RADWS) be developed in which only water intended to be drunk by humans will be required to meet the drinking-water standards.

This became available as the *Rural Agricultural Drinking-water Supply Guideline* (Ministry of Health 2015). This is also discussed briefly in Chapter 19.

## 1.5.6 Point-of-use and point-of-entry drinking-water treatment appliances standards

To facilitate the regulatory control over the performance of point-of-use (POU) and point-of-entry (POE) drinking-water treatment appliances, the documentation of the appliance needs to specify:

- a) what contaminants the appliance will control
- b) what contaminants the appliance will NOT control
- c) performance standards for control of the contaminants of concern
- d) a clear indication of when the appliance is no longer achieving its performance standards.

There are four relevant international standards that deal with POU and POE appliances:

- 1 AS/NZS 4983:1998 Water supply – Domestic type water treatment appliances – Performance requirements
- 2 AS/NZS 3497:1998) Amended Plumbing Requirements for POU and POE appliances
- 3 NSF/ANSI 53, and
- 4 NSF/ANSI 55.

Of these standards only AS/NZS 3497:1998 includes the documentation requirements specified above.

The technical performance specifications of AS/NZS 4983 need to be brought up to the standard of the specifications of NSF/ANSI 53 and NSF/ANSI 55 in order to ensure that the appliance will deliver water that complies with the DWSNZ.

## 1.6 Tools for promoting potable drinking-water supplies

### 1.6.1 Introduction

From 1992 to 1996 the Ministry of Health developed an integrated set of tools for improving drinking-water quality to protect public health. These tools were designed in such a way that they reinforce one another in use and included the:

- public health grading of community drinking-water supplies
- the 1995 *Drinking-water Standards for New Zealand*
- development of national drinking-water databases, eg, WINZ
- and publication of:
  - *Register of Community Drinking-water Supplies in New Zealand*
  - *Guidelines for Drinking-water Quality Management in New Zealand*
  - *Annual Reports on Quality of Drinking-water in New Zealand*.

Subsequently, the following new tools have been added:

- the introduction of water safety plans
- the introduction of drinking-water assessment and the training of personnel for this
- publication of the *Register of Recognised Laboratories*
- publication of the *Register of Drinking-water Assessors*.

Several of these tools have been updated since 2000, eg, the DWSNZ, the Guidelines, the Grading, and the WINZ software (now called Drinking-water Online).

The tools are designed to promote maximum interaction and mutual support between the various stakeholders, the public, the media, the drinking-water supplier, and the drinking-water assessor. Emphasis is on using risk management planning techniques to promote a quality assurance approach. This is complemented by a monitoring programme used as a final quality control that also acts as a feedback loop and provides a trigger for remedial action where this is necessary.

A description of the tools used by the Ministry of Health, and the way they interact, follows in sections 1.6.4 to 1.6.15.

## 1.6.2 Four tools used by the World Health Organization

The World Health Organization uses four approaches when considering health-based targets.

- 1 The tolerable burden of disease. This is called disability-adjusted life years (DALYs) which can be used to quantify and compare the burden of disease associated with different water-related hazards, taking into account varying probabilities, severities and duration of effects, regardless of the type of hazard (microbial, chemical or radiological) to enable the use of a consistent approach for each hazard. WHO has used DALYs to evaluate public health priorities and to assess the disease burden associated with environmental exposures, particularly for microbial hazards. The tolerable burden of disease is defined as an upper limit of  $10^{-6}$  DALY ( $\mu$ DALY) per person per year. This upper-limit DALY approximates a  $10^{-5}$  excess lifetime risk of cancer (ie, 1 excess case of cancer per 100 000 people ingesting drinking-water at the water quality target daily over a 70-year period), which is the risk level WHO uses to determine guideline values for genotoxic carcinogens. See section 3 in WHO 2017 for further information.
- 2 Guidelines values. Guideline values for chemicals are based on individual chemical risk assessments. These are called maximum acceptable values (MAVs) in the DWSNZ.
- 3 Specified removal of hazards. These are usually expressed as log reductions. This approach has been adopted in the DWSNZ for protozoa.
- 4 Defined technologies. This usually involves use of validated treatment equipment such as UV disinfection, membrane and cartridge filtration.

## 1.6.3 The six guiding principles of drinking-water safety

The Australian Drinking-water Guidelines incorporate six well-established principles for potable drinking water. The principles were developed in 2001 by a working group comprising the World Health Organisation microbial pathogens expert group and the Medical Research Council of Australia.

### Principle 1: A high standard of care must be embraced

Unsafe drinking water can cause illness, injury or death on a large-scale. All those involved in supplying drinking water (from operators to politically elected representatives) must therefore embrace a high standard of care akin to that applied in the fields of medicine and aviation where the consequences of a failure are similarly detrimental to public health and safety. Vigilance, diligence and competence are minimum requirements and complacency has no place.

## Principle 2: Protection of source water is of paramount importance

Protection of the source of drinking water provides the first, and most significant, barrier against drinking water contamination and illness. It is of paramount importance that risks to sources of drinking water are understood, managed and addressed appropriately. However, as pathogenic microorganisms are found everywhere, complete protection is impossible and further barriers against contamination are vital.

## Principle 3: Maintain multiple barriers against contamination

Any drinking water system must have, and continuously maintain, robust multiple barriers against contamination appropriate to the level of potential contamination. This is because no single barrier is effective against all sources of contamination and any barrier can fail at any time. Barriers with appropriate capabilities are needed at each of the following levels: source protection; effective treatment; secure distribution; effective monitoring; and effective responses to adverse signals. A “source to tap” approach is required.

## Principle 4: Change precedes contamination

Contamination is almost always preceded by some kind of change and change must never be ignored. Sudden or extreme changes in water quality, flow or environmental conditions (for example, heavy rainfall, flooding, earthquakes) should arouse particular suspicion that drinking water might become contaminated. Change of any kind (for example, personnel, governance, equipment) should be monitored and responded to with due diligence.

## Principle 5: Suppliers must own the safety of drinking water

Drinking water suppliers must maintain a personal sense of responsibility and dedication to providing consumers with potable water. Knowledgeable, experienced, committed and responsive personnel provide the best assurance of potable drinking water. The personnel, and drinking water supply system, must be able to respond quickly and effectively to adverse monitoring signals. This requires commitment from the highest level of the organisation and accountability by all those with responsibility for drinking water.

## Principle 6: Apply a preventive risk management approach

A preventive risk management approach provides the best protection against waterborne illness. Once contamination is detected, contaminated water may already have been consumed and illness may already have occurred. Accordingly, the focus must always be on preventing contamination. This requires systematic assessment of risks throughout a drinking water supply from source to tap; identification of ways these risks can be managed; and control measures implemented to ensure that management is occurring properly. Adequate monitoring of the performance of each barrier is essential. Each supplier’s risk management approach should be recorded in a living WSP which is utilised on a day to day basis.

## 1.6.4 Drinking-water Standards for New Zealand

WHO (2017) considers the functions of surveillance and quality control are best performed by separate and independent entities because of the conflict of interest that arises when the two are combined. In this:

- national agencies provide a framework of targets, standards and legislation to enable and require suppliers to meet defined obligations
- agencies involved in supplying water for consumption by any means should be required to ensure and verify that the systems they administer are capable of delivering potable water and that they routinely achieve this
- a surveillance agency is responsible for independent (external) surveillance through periodic audit of all aspects of safety and/or verification testing.

The DWSNZ in 1995, 2000, 2005 and 2008 were based on the following principles.

1. The DWSNZ define the maximum concentrations of chemicals of health significance (MAVs) in water that, based on current knowledge, constitute no significant risk to the health of a person who consumes 2 L of that water a day over their lifetime (usually taken as 70 years).

**Potable water** is drinking-water that does not contain or exhibit any determinand to any extent that exceeds the MAVs specified in the DWSNZ (see the definition of 'potable' in section 69G of the Act).

The DWSNZ do not purport to specify a concentration of contaminant at which zero risk exists because a degree of uncertainty over the magnitude of the risk always exists. The datasheets in the Guidelines (vol 3) provide information on each determinand.

2. The DWSNZ give highest priority to health risks arising from microbial contaminants because they can lead to rapid and major outbreaks of illness. Control of microbial contamination is of paramount importance and must not be compromised in an attempt to correct chemical problems, such as disinfection by-product (DBP) formation.
3. The DWSNZ set priorities on how to ensure that, while public health is protected, scarce resources are not diverted to monitoring substances of relatively minor importance.
4. The DWSNZ set out to protect public health and apply only to health-significant determinands.

However, because the public generally assesses the quality of its water supply on aesthetic perceptions, guideline values for aesthetic determinands are also provided (DWSNZ section 2), although they are not part of the water quality standards.

**Wholesome drinking-water** is potable water that does not contain or exhibit any determinands that exceed the guideline values for aesthetic determinands in the DWSNZ (see the definition of 'wholesome' in section 69G of the Act). For more details, see chapter 18.



5. To demonstrate compliance with the MAVs, water suppliers need to follow the relevant sampling and testing programmes detailed in sections 4, 5 and 7 to 12 of the DWSNZ.
6. Where feasible, the sampling protocols are designed to give 95 percent confidence that no determinand in a supply has exceeded its MAV for more than 5 percent of the time.

The MAVs for micro-organisms are determined differently from those for chemicals.

- a) The MAV of a micro-organism is its concentration in drinking-water above which there is a significant risk of contracting a waterborne (enteric) disease.
- b) Because of the limitations of existing microbial technology, MAVs are not given for all micro-organisms of health significance (eg, all pathogens). Instead MAVs are given for the representative organisms *Escherichia coli* (*E. coli*) for the bacteria and *Cryptosporidium* plus *Giardia* (representing the protozoa).
- c) *E. coli* is used as an indicator of bacterial risk because it indicates the presence of faecal material and, therefore, the potential presence of pathogenic bacteria.
- d) There are no MAVs for viruses; water that meets bacterial and protozoal compliance is deemed to virologically satisfactory.

The DWSNZ also prescribe MAVs for the determinands of public health significance other than micro-organisms. These MAVs are the concentrations of determinands below which there is no significant risk to a consumer over a lifetime of consumption assessed at 2 litres per day.

MAVs for chemical determinands of health significance are given in Tables 2.2 and 2.3 of the DWSNZ. Because the relationship between cyanobacterial numbers and toxin production is highly variable, no attempt is made to develop MAVs for cyanobacteria, but they are developed for their cyanotoxins.

Wherever possible, the MAVs have been based on the latest WHO guideline values. WHO calls their guideline values provisional when there is a high degree of uncertainty in the toxicology and health data, or if there are difficulties in water treatment or chemical analysis. The DWSNZ adopt the same approach. Provisional MAVs (PMAVs) have also been applied to chemical determinands when the Ministry of Health has derived a MAV in the absence of a WHO guideline value. In terms of compliance with the DWSNZ, PMAVs are considered to be equivalent to MAVs.

Chemical MAVs are based on average values, and while a higher daily dose could be safe for a certain period, consumption of that dose for a lifetime is not expected to be safe. Average values are used for framing Regulations because provision cannot be made for all possible combinations of exposures that individuals may encounter; an exception is cyanide where the MAV has been established to protect consumers during short-term exposure following a significant spill of cyanide to a drinking-water source (see datasheet in the Guidelines). There is a short-term MAV for nitrate and nitrite as well, established to protect against methaemoglobinaemia in bottle-fed infants.

For carcinogenic chemicals, the MAVs set in the DWSNZ generally represent a risk of one additional incidence of cancer per 100,000 people ingesting the water at the concentration of the MAV for 70 years.

For most other chemicals, MAVs have been calculated using a tolerable daily intake (TDI) approach that identifies the dose below which no evidence exists that significant adverse effects will occur and that will represent no significant risk to a consumer from a lifetime of consumption of 2 L of the water per day. The derivations of the MAVs are explained in the datasheets in the Guidelines.

MAVs apply to water intended for human consumption, food preparation, utensil washing, oral hygiene or personal hygiene. Approximately one third of the daily average fluid intake is thought to be derived from food. The remaining water requirement must be met from consuming fluids. The criteria in the DWSNZ are applicable to all drinking-water except bottled water, which must comply with the Food Act 1981.

The WHO assesses determinands for which health concerns have been raised and has found many are unlikely to occur in drinking-water or occur at levels well below those at which toxic effects are observed. Datasheets for these determinands appear in the Guidelines.

The DWSNZ list the maximum concentrations of chemical, radiological and microbiological contaminants acceptable for public health in drinking-water. For community drinking-water supplies, the DWSNZ specify the sampling frequencies and testing procedures that must be used to demonstrate that the water complies with the DWSNZ.

The sampling frequencies are chosen to give 95 percent confidence that the medium to large drinking-water supplies comply with the Standards for at least 95 percent of the time. The larger supplies are required to monitor more frequently. The DWSNZ 1995 used classical statistics to derive the necessary monitoring frequencies, but the DWSNZ 2000 took advantage of more recent advances in the use of statistics in which monitoring frequencies are derived using the Bayesian approach (McBride and Ellis 2000). For further information, refer to the Appendix.

The DWSNZ do not describe how a water supply should be managed. This should be covered in the water safety plans. Water supply management is also discussed in the *Guidelines for Drinking-water Quality Management in New Zealand*.

The DWSNZ specify MAVs for more than 120 determinands. To minimise the number of determinands that have to be monitored routinely in any specific drinking-water supply but still maintain adequate safeguards to public health, the DWSNZ have grouped the determinands of public health concern into three priority classes, see section 1.6.10 and Table 1.5. The Appendix includes a discussion on how to handle 'non-detects' or 'less than values'.

The potential indicators of disease-causing organisms, micro-organisms characteristic of faecal contamination, are given the highest priority (Priority 1), in the DWSNZ because the public health implications of disease organisms in the water supply are almost always of greater concern than the presence of chemical contaminants, which are usually slower acting.

It can be seen that the top priority is given to identifying potential causes of infectious disease outbreaks. In an ideal world a screening test would be used that provides instant identification of the presence of pathogenic organisms in drinking-water. At present no such test exists. Until better tests have been developed, New Zealand, like the rest of the world, has to fall back on the use of indicator organisms to identify the probability that the water has been contaminated by excrement and, therefore, the possibility that pathogenic bacteria or viruses are present. Because of the practical difficulties in routinely enumerating infectious protozoa in drinking-water, surrogate methods have had to be used, based on checking that the water is from a safe source or has received a level of treatment that has a high probability of removing protozoal organisms.

Information on the supply-specific Priority 2 determinands, ie, those determinands in a drinking-water supply that are of public health concern, is published in the *Annual Review* (see section 1.6.12).

The MAVs in the DWSNZ apply to private and individual household drinking-water supplies as well as to community supplies. Because of the wide variation in the circumstances of individual supplies it is not possible to give explicit guidance on sampling strategies for individual supplies in the DWSNZ. Individual household supplies are discussed in Chapter 19 of these Guidelines. Advice on specific cases can be obtained from the drinking-water assessors.

Compliance with the DWSNZ demonstrates that a drinking-water supply is potable within the meaning of the Act. The DWSNZ:

- 1 specify bacteriological referee methods against which the methods used by individual laboratories have to be calibrated satisfactorily
- 2 require that laboratories carrying out compliance testing be approved for the purpose by the Ministry of Health
- 3 specify minimum remedial action needed in the event of the DWSNZ being breached.

## 1.6.5 Guidelines for Drinking-water Quality Management in New Zealand

The *Guidelines for Drinking-water Quality Management in New Zealand* (the Guidelines) provide more detailed information on the public health management of drinking-water and the properties of drinking-water determinands of public health concern than appears in the DWSNZ. They provide access to information on public health aspects of drinking-water to water supply personnel, health personnel and the general public. The original *Guidelines* were published in 1995 and were directed mainly at small supplies and some self-suppliers. The 2005 edition and subsequent revisions are directed at all water supplies.

The *Guidelines* provide background and supporting information for the DWSNZ and will be revised as necessary. The *Guidelines* contain:

- guidance and good management principles for community drinking-water supplies
- volume 1 includes the chapters. Chapters 1–5 are largely introductory and discuss risk management, and source water. Chapters 6–11 discuss compliance issues. Chapters 12–18 relate to operating and maintaining the supply. Chapter 19 covers small supplies
- the datasheets, in volume 2, describe how the criteria used in the DWSNZ were derived.

These datasheets also provide background information about each determinand including their sources, environmental forms and fates, typical concentrations either in New Zealand or overseas drinking-water supplies, processes for removing the determinand from drinking-water, analytical methods, health considerations, derivation of the MAVs for health significant determinands and Guideline Values for aesthetic determinands, and references for further reading. Datasheets for determinands of possible health and aesthetic significance and are included for general information.

## 1.6.6 Water safety plans

The introduction of public health risk management plans (PHRMPs – now known as Water Safety Plans) in 2001 marked the transition from drinking-water quality management procedures from purely quality control (monitoring compliance against product quality standards) to a combination of QC and quality assurance (QA). Prior to 2001 public health management of supplies relied largely on compliance monitoring of the quality of the water produced by individual water suppliers to check that it complied with the DWSNZ. While monitoring is always important, WSPs for drinking-water supplies provide the additional benefit of introducing management procedures that reduce the likelihood of contaminants entering supplies in the first place. By the time monitoring shows that contaminants are present, something has already gone wrong and a hazard is already present in the water. But identifying and managing risks should prevent hazards arising.

WSPs encourage the use of risk-management principles during treatment and distribution so that monitoring is not the only water quality management technique used thereby further reducing the risk of contamination.

To assist drinking-water suppliers to develop WSPs for their drinking-water the Ministry of Health produced 39 PHRMP Guides covering the system elements (eg, filtration, disinfection, water storage, distribution etc) that are most frequently found in drinking-water supplies. The model PHRMP Guides are available at <http://www.health.govt.nz/water> then select publications and Public Health Risk Management Plans ~ Reference Guides. WSPs are discussed in detail in Chapter 2: Management of Community Supplies.

The first item, How to prepare and develop public health risk management plans for drinking-water supplies should be read before using any of the PHRMP Guides because it explains the risk management process and how the different guides are intended to be used to build up a WSP for a particular water supply.

Subsequently, in 2005, simplified WSP procedures and multi-media training material were developed especially for use by small water supplies and published, together with related training CDs, as an integral part of the DWAP TAP.

All but the smallest community water supplies are required to prepare and implement a WSP (HDWAA section 69Z). The timetable for compliance with this requirement is set out in HDWAA sections 69C to 69F. Water supplies that are smaller than neighbourhood supplies (usually smaller than 25 persons) are not required to have WSPs unless specifically required to do so by the Medical Officer of Health.

The preparation of an approved WSP by a drinking-water supplier provides one way of demonstrating that all practicable steps have been taken to meet the requirements of the proposed drinking-water legislation (HDWAA section 69H), because it:

- identifies the nature and magnitude of public health risks inherent in the water supply process
- specifies what preventive and corrective procedures should be in place to manage/mitigate each risk
- identifies what will be done by the supplier to mitigate the risks
- identifies what the supplier is not able to do to mitigate the risks because of resource limitations.

## 1.6.7 Public health grading of drinking-water supplies

The grading of community drinking-water supplies is a voluntary system that has been in place in various forms since 1962. The current grading system was updated in 2003 to incorporate changes introduced by the *Drinking-water Standards for New Zealand 2000*. There is no requirement for a water supplier to participate in grading. If a water

supplier chooses not to be graded, the supplier is recorded in the *Register of Drinking-water Supplies in New Zealand* as being ungraded.

In 2008, following the amendments to the Health Act 1956 that introduced a statutory compliance regime for drinking-water supplies, ESR Ltd surveyed water supply stakeholders to see if there was support for a new grading framework. The survey found that grading was still regarded by water suppliers as an important tool, and the purpose of providing a public statement of safety was still desirable. Stakeholders agreed however that the existing framework did not satisfactorily account for risk. It had no provision for water safety plans (WSPs), or for the requirements of the *Drinking-water Standards for New Zealand 2005 (revised 2008)*.

At the time of writing the consultation on revision of the Grading Framework had closed with submissions being analysed.

## 1.6.8 Drinking-water assessment

The role of the Drinking-water Assessors (DWAs) is to verify that the requirements of the Health Act 1956 as they relate to drinking-water have been complied with. The DWAs are appointed by the Director-General of Health, and have the following set of tasks and their functions are set out in section 69ZL of the Act.

DWAs are located in District Health Board public health units and are accredited as authorised signatories. Maintenance and public access to a Register of Drinking-water Assessors is a requirement of the Act's section 69ZX. The Register can be accessed at: <http://www.health.govt.nz/water> then select legislation.

## 1.6.9 Monitoring

Assesses the extent to which a drinking-water supply complies with the DWSNZ at the time of monitoring.

Monitoring of the quality of a community drinking-water supply was made the responsibility of the drinking-water supplier in the DWSNZ 1995. Previously, under the DWSNZ 1984, monitoring had been carried out by the (then) Department of Health.

To demonstrate compliance with the DWSNZ, the Priority 1 and 2 determinands have to be monitored according to the protocols set down in the DWSNZ. The DWSNZ specify the minimum frequency of compliance monitoring. Water suppliers also conduct process control testing and quality assurance monitoring as part of their day-to-day management. Process control test results can be used for compliance monitoring if the procedure used complies with the requirements of the DWSNZ.

## 1.6.10 Surveillance

Surveillance requires a systematic programme of surveys, which may include auditing, analysis, sanitary inspection and institutional and community aspects. It should cover the whole of the drinking-water system, including sources and activities in the catchment, transmission infrastructure, treatment plants, storage reservoirs and distribution systems (whether piped or unpiped) (WHO 2017).

The definition of surveillance in the DWSNZ is: the process of checking that the management of drinking-water supplies conforms to the specifications in the Drinking-water Standards for New Zealand (DWSNZ); usually conducted by the public health agency. An example of surveillance is the process that results in a chemical determinand being assigned as a P2 (see next section).

The WHO Guidelines describe drinking-water supply surveillance as “the continuous and vigilant public health assessment and review of the safety and acceptability of drinking-water supplies”. This surveillance contributes to the protection of public health by promoting improvement of the quality, quantity, accessibility, coverage, affordability and continuity of water supplies (known as service indicators) and is complementary to the quality control function of the drinking-water supplier. Drinking-water supply surveillance does not remove or replace the responsibility of the drinking-water supplier to ensure that a drinking-water supply is of acceptable quality and meets predetermined health-based and other performance targets.

## 1.6.11 Identifying priority 2 and priority 3 determinands

Between 1995 and 2004, the Ministry of Health’s Priority 2 Chemical Determinands Identification Programme assessed drinking-water supplies to identify which chemical determinands needed to be assigned as Priority 2 determinands. Since then water suppliers have been responsible for identifying in their Water Safety Plan chemicals of health concern in their own water supplies as the drinking-water sections of the Health Act 1956 come into force for their supplies. The procedure, with advice to help identify determinands that might be of concern, is described in *Priority 2 and Priority 3 Chemical Determinands Identification Guide*, produced by ESR for the Ministry in 2015.

The *Guide* also includes recommendations for monitoring Priority 3 determinands, because no requirements for sampling Priority 3 determinands are contained in the DWSNZ. However, there are situations in which sampling for them is a necessary part of good public health risk management. For example, where a determinand is present at concentrations near the MAV in the source water, its concentration in the distribution zone may be reduced to a level less than 50 percent of the MAV by treatment. Changes in treatment efficacy could cause the determinand’s concentration in the reticulated water to exceed 50 percent of the MAV.

**Table 1.5: Examples of priority allocation in the DWSNZ<sup>11</sup>**

| Priority  | Example of determinands  |
|---|--|
| <b>Priority 1</b><br>Applies to all community drinking-water supplies   | <i>Escherichia coli</i> ( <i>E. coli</i> )<br><i>Giardia</i><br><i>Cryptosporidium</i>   |
| <b>Priority 2</b><br>Applies to determinands where there is good reason to believe that the substance is present in concentrations that present a potential public health risk (this priority is specific to the particular supply) | Chemical and radiological determinands that could be introduced into the drinking-water supply by the treatment chemicals at levels potentially significant to public health (usually greater than 50 percent MAV) eg, acrylamide monomer where low specification polyacrylamide is used as a coagulant aid.<br>Chemical and radiological determinands of health significance that have been demonstrated to be in the drinking-water supply at levels potentially significant to public health (usually greater than 50 percent MAV) eg, arsenic and boron in geothermal areas.<br>Micro-organisms (other than priority 1) of health significance which have been demonstrated to be present in the drinking-water supply |
| <b>Priority 3</b><br>Applies to determinands not likely to be present in the supply to the extent where they could present a risk to public health  | Chemical and radiological determinands of health significance which are not known to occur in the drinking-water supply at greater than 50 percent MAV.<br>Micro-organisms of health significance which could be present in the drinking-water supply.<br>Determinands of aesthetic significance that may occur in the drinking-water supply.  |

## 1.6.12 Register of Community Drinking-water Supplies and Suppliers in New Zealand

The *Register of Community Drinking-water Supplies and Suppliers in New Zealand* is a requirement of the Health Act (s69J). It is a public document that provides easily accessible information about community water supplies and drinking-water carriers.

For each supply, the Register records:

- the name and address of the drinking-water supplier or carrier
- the source(s) of the supply
- unique codes for each component (to aid clear identification)
- when the supply was first registered
- category of the supply.

## 1.6.13 Annual Review of Drinking-water Quality in New Zealand

The *Annual Review of Drinking-water Quality in New Zealand* provides a public statement of the extent to which a community water supply (serving over 100 people) complies with the requirements of the Part 2A Health Act 1956.

<sup>11</sup> The priority classification scheme was introduced to give guidance as to the relative public health concern relating to the many determinands of public health significance that are listed in the WHO *Guidelines for Drinking-water Quality*. A detailed discussion of the priority classes is given in the DWSNZ.



Publication of an annual report is a requirement of the Director-General under section 69ZZZB. Annual reviews are available at <http://www.health.govt.nz/water> (then select publications).

## 1.6.14 Register of recognised laboratories

To be accepted by the Ministry of Health for the purpose of analysing samples for compliance with the DWSNZ, a laboratory must satisfy the Ministry that it:

- requires suppliers who send samples from community drinking-water supplies for analysis for the purpose of demonstrating compliance with the DWSNZ, to identify all such samples with the appropriate unique site identification code as listed in the current *Register of Community Drinking-water Supplies and Suppliers in New Zealand*
- has been recognised by an appropriate accreditation or certification authority as competent to perform those analyses for which acceptance by the Ministry is sought (this would involve accreditation to NZS/ISO/IEC 17025 [IANZ 2005] or equivalent). This includes IANZ accredited laboratories and laboratories recognised by IANZ as complying with Ministry of Health Level 2 Criteria (IANZ 2007)
- is operating appropriate quality assurance procedures
- is using bacteriological methods that have been calibrated against the referee methods specified in the DWSNZ. Laboratories conducting chemical tests for compliance purposes may use the test methods for which they have been assessed by IANZ and found to be competent to perform
- is actively engaged in on-going inter-laboratory method-comparison programmes to compare the results of their analyses of the determinands for which they wish to be accepted by the Ministry with analyses on those determinands carried out by other laboratories accepted by the Ministry.

Other requirements may be added from time to time.

The Register of Recognised Laboratories is available via <http://www.health.govt.nz/water> (under Drinking-water/Legislation/Related websites).

## 1.6.15 Records

The duty to keep records and make them available is covered in section 69ZD of the Act. Records must be kept of the results of monitoring drinking-water determinands. The records are necessary to demonstrate that the DWSNZ are being complied with. They are an essential requirement for the public health grading of drinking-water supplies. The records must include the following.

- The name of the supply, treatment plant(s) and distribution zone(s) to which the information relates and the unique supply component code listed in the Register of Drinking Water Suppliers for New Zealand (<http://www.health.govt.nz/>). If the water

supply has not been registered, this should be undertaken with the Ministry of Health.

- The relevant supply codes must be included in all correspondence with the Ministry of Health or drinking-water assessor (DWA).
- Up-to-date records of the resident population in the district served by the supply.
- The information that is recorded must, to the satisfaction of the DWA, be sufficient for the purposes of assessing compliance with the DWSNZ.
- Online data records may be compressed using a procedure that preserves the accuracy of the original measurements. Data must be reported as a percentage of the time (or duration, where required) that the value was exceeded (or met) during the compliance monitoring period.
- Information collected during catchment assessments, sanitary inspections of the water supply, inspections of bore head protection, and data gathered during the protozoal risk categorisation process.
- All monitoring results of the raw water or water entering the treatment plant that are required for the protozoal risk categorisation.
- The treatment processes in operation at the beginning of the year being reported and any modifications that changed the process during the previous year.
- Unless analysing for Priority 2a determinands, the concentration of any impurities in the chemicals being dosed. This should include the calculations used that proved analysis of the impurities was not needed.
- Anything that could significantly affect water quality that has occurred in the drinking-water supply system or catchment.
- A log of observations made of the appearance of the source water where regular source inspections are required.
- The determinands monitored during the year. If any Priority 1 or Priority 2 determinands have not been monitored or have been monitored at less than the required frequency, the reasons must be recorded, with corroborating data where appropriate.
- The sampling frequency for each determinand, the dates and times on which the measurements were made (for samples before and after flushing where this is necessary), the sampling site location, the supply component code, the name of the sampler(s) and the analytical results.
- Any remedial action taken as a result of the level of a determinand exceeding the MAV or because the water supplier considered it necessary.
- The analytical method used and the limit of detection and uncertainty for each of test method.
- The name of the laboratory used for the analyses as listed in the Ministry of Health's Register of Recognised Laboratories for New Zealand  
<http://www.health.govt.nz/water>.
- Any re-evaluation of the operational programme undertaken and the reasons for this. Notes concerning treatment modification have been discussed above, but changes in the operation or the materials used in the reticulation should also be noted where appropriate.
- Operational records, including process changes and operational monitoring.

- Copies of all equipment validations or certifications.
- The names, relevant qualifications and experiences of staff supervisors and operators.

Proper internal documentation of the monitoring programme will enable water suppliers to collate this information easily. Using the Drinking-water Online database (available through the Ministry of Health) will assist suppliers to calculate compliance and maintain the necessary records in the correct format.

## 1.7 Other drinking-water requirements

### 1.7.1 Drinking-water quality at airports

Annex 1 B 1(d) of the International Health Regulations (IHR) (WHO 2005) requires every designated airport location worldwide to develop the capacity to provide potable water for the aircraft that use their facilities. However, it is the responsibility of each aircraft operator to ensure that these standards are being upheld, not just in terms of the quality of the water taken on board from the source of supply on the ground. In accordance with Article 24(c) of the IHR (WHO 2005) states shall take all practicable measures to ensure that conveyance operators keep the water system free of sources of contamination and infection.

Airports should comply with the core capacity requirements of Annex 1 B 1(d) and the role of the competent authorities to ensure, as far as practicable, that the facilities are in sanitary condition and kept free of sources of infection and contamination, as per Article 22(b), such as providing potable water from a uncontaminated source approved by the competent authority.

For further information, see WHO (2009).

Note that the US established in 2009 an Aircraft Drinking Water Rule, for details, see <http://water.epa.gov/lawsregs/rulesregs/sdwa/airlinewater/index.cfm>

### 1.7.2 Drinking-water quality in shipping

Historically ships have played an important role in transmitting infectious diseases around the world. For example, the spread of cholera pandemics in the 19th century was thought to be linked to trade routes, and facilitated by merchant shipping.

The purpose of the International Health Regulations is “to provide security against the international spread of disease while avoiding unnecessary interference with international traffic”.

Waterborne outbreaks have been associated with loading poor quality water. Therefore, the first waterborne disease prevention strategy should be to load ships with the safest water available at port. To support this objective, ports should make good quality potable water available to ships.

Potable water for ships, including water-boats and water-barges, needs to be obtained only from those water sources and water supplies that provide potable water of a quality in line with the standards recommended in the *Guidelines for Drinking-water Quality* (WHO 2004), especially in relation to bacteriological requirements and chemical and physical requirements.

Potable water would typically need to be obtained from those watering points approved by the health administration or health authority. Facilities include piping, hydrants, hoses and any other equipment necessary for the delivery of water from shore sources at the pier or wharf area to the filling line for the ship's potable water system. Plans for the construction or replacement of facilities for loading potable water aboard vessels would typically be submitted to the port health authority or other designated authority for review.

For further information, see WHO (2007 and 2011a).

Note: The International Health Regulations (2005), hereafter referred to as IHR (2005), are an international WHO legal framework addressing risks of international disease spread and legally binding on 194 states parties throughout the world, including all 193 WHO member states. The IHR (2005) are very broad, focusing upon almost all serious public health risks that might spread internationally, whether biological, chemical or radionuclear in origin, and whether transmissible in goods (including food), by persons, on conveyances (aircraft, ships, vehicles), through vectors or through the environment. The IHR (2005) contain rights and obligations for states parties (and functions for WHO) concerning prevention, surveillance and response; health measures applied by States to international travellers, aircraft, ships, ground vehicles and goods; and public health at international ports, airports and ground crossings. For more information, see <http://www.who.int/csr/ihr/en/>.

## 1.8 Emergency supplies and emergencies

Emergencies may result from contamination of the source water, loss of supply from the source due to drought or flood damage, failure at the treatment plant, or distribution system problems due to main breaks, pump failure, power supply failure, earthquake, etc.

Emergencies and contingencies are discussed in a general or planning manner in Chapter 2 of the Guidelines, sections 2.1, 2.2, 2.2.2.3, 2.2.2.4, 2.2.2.5, 2.2.3, and 2.2.4.2.

When the drinking-water may not be safe to drink, some water suppliers invoke a boil water notice (Chapter 6 includes an Appendix: Boil Water Notices). Other water

suppliers may deliver water by tanker: see section 1.5.4 of these Guidelines and Ministry of Health (2008).

Some water suppliers have developed emergency water supplies specifically for longer term use after events such as earthquakes.

Emergency supplies must meet Priority 1 MAVs or requirements.

However, chemical determinands are less serious because their MAVs are based on consumption of two litres per day over a lifetime, ie, chronic MAVs. Aesthetic determinands are even less serious, unless the taste or odour is sufficient to cause consumers to seek an alternative, and possibly less safe, source.

During an emergency the concentration of a chemical determinand may exceed its MAV. Whether this is important will depend on the chemical, its concentration and duration. See section 10.2.3 and, particularly, section 10.2.5 of the Guidelines for discussion about acute MAVs and their derivation.

Chemical determinands can cause health or aesthetic issues due to volcanic eruptions, or accidental discharges or spills upstream of a water supply intake. Managers of water supplies at risk are advised to communicate with the various organisations in their area with responsibility for managing hazardous wastes. These include the Fire Service, NZ EPA, Police, regional councils and territorial local authorities. The National HazMat Coordination Committee (NHCC) is chaired by the NZFS, and comprises senior representatives from the NZ EPA, Worksafe New Zealand, New Zealand Police, the Ministry of Health, Maritime New Zealand, Civil Aviation Authority, New Zealand Defence Force, and Responsible Care New Zealand.

Bush fires are common in Australia and can have serious effects on water supplies. Their Department of Health has published guidance for people using rainwater supplies, Australian DoH (2011). Guidance on fire retardant chemicals has also been published, see Victoria State Government (2015) and Queensland Government (2018).

## Appendix 1: Statistical issues that relate to the Drinking-water Standards of New Zealand

### Contents

|           |  |           |
|-----------|--|-----------|
| <b>A1</b> | <b>Compliance rules for percentile standards</b> | <b>49</b> |
|           | Classical evaluation of risks                    | 50        |
|           | Bayesian evaluation of risks                     | 51        |
|           | Choice of priors                                 | 52        |

|                                |           |
|--------------------------------|-----------|
| Timeframe for compliance       | 52        |
| Compliance for small supplies  | 53        |
| Compliance for other supplies  | 53        |
| <b>A2 Handling non-detects</b> | <b>55</b> |

### List of tables

|  |    |
|--|----|
| Table A1.1: Numbers of samples and allowable transgressions needed to keep maximum risks below 5 percent when assessing compliance with a 95th percentile standard | 51 |
| Table A1.2: Allowable exceedances (for 95 percent confidence that the MAV is exceeded for no more than 5 percent of the time)                                      | 54 |

### List of figures

|  |    |
|--|----|
| Figure A1: Bayesian confidence of compliance curves for a 95th percentile standard, using Jeffreys' uninformative        | 52 |
| Figure A2: Fitting a lognormal distribution to >L data (where L = 5), and extrapolating back to obtain values of <L data | 56 |

Two issues are presented in outline herein:

- developing compliance rules for percentile standards
- handling non-detect data.

The 1995 Guidelines had a rather full presentation of these, but recent publications: Helsel 2005 and McBride 2005, have elucidated the arguments in full and need not be repeated.

## A1 Compliance rules for percentile standards

The purpose of a drinking-water monitoring programme is to get as accurate a picture of the water quality as possible over the period of time and geographical area of interest. The reliability of the picture produced by the monitoring data is dependent on, amongst other things, the number of samples taken to construct it. The larger the number of samples, the more reliable the conclusions reached about the water quality are likely to be. Samples should be taken at random. Systematic sampling can introduce bias into the results by failing to detect patterns occurring outside the sampling schedule. Constraints on the resources available for monitoring programmes, however, limit the number of samples that can be collected. It is therefore necessary to use statistical calculations to determine the number of samples that must be taken to provide the required level of confidence in the conclusions reached from the data.

The *Drinking-water Standards for New Zealand (2005, revised 2008, and revised 2018)* (DWSNZ) are designed to work to 95 percentile standards (as discussed in section 6.2 of these Guidelines). Hereafter we will discuss only the 95th percentile case.

In other words, they aim to ensure that in a supply that complies with the DWSNZ, health-significant determinands are present at levels less than their MAVs for 95 percent or more of the time. Note that this is 95 percent of the time, not 95 percent of the samples. This is a deliberate choice. Variability in such things as the quality of the water and false positive results mean that with the limited monitoring data available, there will be a degree of uncertainty as to the ability of a supply to meet the 95th percentile requirement. The DWSNZ are based on a 95 percent confidence that the 95th percentile is being met. From these two parameters, 95 percent confidence in acceptable water quality for 95 percent of the time, the number of monitoring samples required for demonstrating compliance can be calculated.

In the 1995 edition of the DWSNZ these calculations were made using classical statistical methods. In the DWSNZ 2000 and 2005/2008 the classical basis has been replaced by the use of a Bayesian statistical method. The main consequence of this change is that fewer samples need to be taken to demonstrate the same level of confidence in compliance than was the case when the classical calculations were used.

## Classical evaluation of risks

When evaluating whether the value of a determinand is less than, or equal to, its MAV for 95 percent of the time in a classical framework, one of two types of error can be committed:

- 1 from the number of transgressions it is incorrectly inferred that there was non-compliance. The risk of this occurring is termed the 'supplier's risk'
- 2 from the number of transgressions it is incorrectly inferred that there was compliance. The risk of this occurring is termed the 'consumer's risk'.

To quantify these risks using classical statistical methods it is assumed that sampling is random in time. To perform these calculations the probability of a single sample transgressing its MAV must be selected. This is done by assuming that the water is borderline for compliance, ie, the probability of the sample exceeding its MAV is 5 percent (95 percent of the time the MAV is not exceeded implies that 5 percent of the time it is, if the situation is borderline). This assumption of course makes for a very pessimistic approach.

The results obtained from the classical calculations are shown in Table A1.1. They are the basis for the statements made in section 1.3 of the DWSNZ 1995, showing how the number of samples necessary to demonstrate compliance 95 percent of the time depends on the number of samples exceeding the MAV. To keep the consumer's risk to less than 5 percent therefore requires a minimum of 59 samples to be taken, none of which are permitted to transgress the MAV. If one of the monitoring samples transgresses its MAV, there must be at least another 92 that have not exceeded the MAV to be 95 percent confident that the supply is in compliance 95 percent of the time.

**Table A1.1: Numbers of samples and allowable transgressions needed to keep maximum risks below 5 percent when assessing compliance with a 95th percentile standard**

| Number of allowable transgressions | Number of samples required to keep the maximum consumer's risk below 5% using the following methods |                    | Number of samples required to keep the maximum supplier's risk below 5% using the following methods |           |
|------------------------------------|---|--------------------|---|-----------|
|                                    | Classical   | Bayesian*          | Classical   | Bayesian* |
| 0                                  | 59–92 <sup>#</sup>  | 38–76 <sup>#</sup> | 1 <sup>†</sup>  | ‡         |
| 1                                  | 93–123  | 77–108             | 2–7   | 1–3       |
| 2                                  | 124–152   | 109–138            | 8–16  | 4–11      |
| 3                                  | 153–180   | 139–166            | 17–28   | 12–22     |
| 4                                  | 181–207   | 167–193            | 29–40   | 23–34     |
| 5                                  | 208–233   | 194–220            | 41–53   | 35–46     |
| 6                                  | 234–259   | 221–246            | 54–67   | 47–60     |
| 7                                  | 260–285   | 247–272            | 68–81   | 61–74     |
| 8                                  | 286–310   | 273–298            | 82–95   | 75–88     |
| 9                                  | 311–335   | 299–323            | 96–110  | 89–102    |

\* These Bayesian results are obtained using Jeffreys' uninformative prior, as discussed in the next section.

# It is not possible to keep the consumer's risk below 5 percent if less than 59 samples are to hand (classical method) or if less than 38 samples are to hand (Bayesian method with an uninformative (Jeffreys') prior).

† The risk is exactly 5 percent in this case.

‡ It is impossible to keep the supplier's risk below 5 percent if no transgressions are allowed in this Bayesian approach.

## Bayesian evaluation of risks

In the classical approach to calculating these calculations no use is made of any previously obtained data or opinions; a single particular value of the probability of an exceedance occurring is selected (5 percent in this case). In using the Bayesian approach, the probability of exceedance is regarded as a continuous variable about which confidence statements can be made. To do this, use is made of prior knowledge, or opinion, to define beforehand a 'prior' probability distribution. This probability can then be upgraded using the actual data collected to obtain a 'posterior' probability that is termed the 'Confidence of Compliance'. Note that this approach does not require the borderline assumption, so results are *always* less pessimistic than those obtained under the classical approach, for every possible prior.

These calculations lead to Figure A1 from which the required number of samples for a given number of allowable transgressions can be read. Key values from the data sets used to produce these plots are summarised in Table A1.1. These values were contained in Table A1.4 of the 2005 DWSNZ (revised 2008, revised 2018). They now appear as Table A1.2 in this chapter of the Guidelines.



**Figure A1: Bayesian confidence of compliance curves for a 95th percentile standard, using Jeffreys' uninformative**

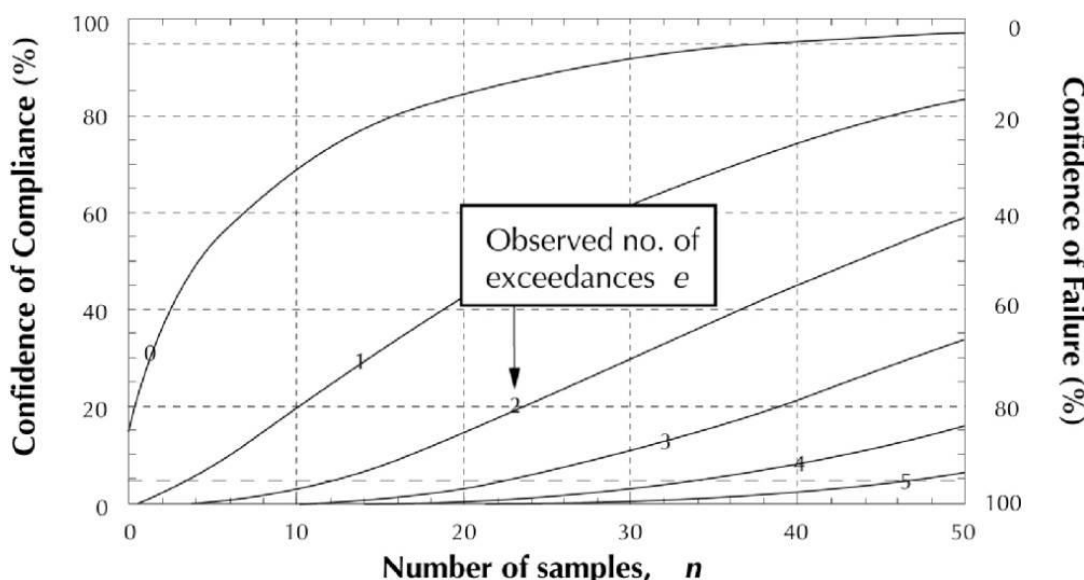

The desired maximum supplier's risk (5 percent) corresponds to confidence of failure = 95 percent, as shown by the long dashed line on each graph. The desired maximum consumer's risk (5 percent) corresponds to confidence of compliance = 95 percent, as shown by the short dashed line on each graph. Details of the calculation procedure and the details of Jeffreys' prior, are given in McBride and Ellis (2001) and McBride (2005).

## Choice of priors

Using the Bayesian approach requires a decision to be made about the nature of the prior probability distribution (the 'prior'). When there is no historical information on which to base a prior, the common-sense approach is to adopt an 'uninformative' prior that best reflects our ignorance of the likelihood of compliance. The calculations for Figure A1, from which results for the DWSNZ were obtained, use the Jeffrey's (uninformative) prior. Strictly, there is no such thing as a truly 'uninformative' prior; any statement about the probability of the state of things is saying something. Nevertheless, the term 'uninformative' is in widespread use in the Bayesian statistical literature. Arguments in favour of the (U-shaped) Jeffrey's prior are given in McBride and Ellis (2001).

There may be situations, however, in which there is prior knowledge of the likelihood of compliance. Bayesian Confidence of Compliance calculations allow account to be taken of this knowledge, and the numbers of samples needing to be taken appropriately modified.

## Timeframe for compliance

The statistics provided in Table A1.1 are independent of time. The number of transgressions that can occur while still keeping the risk to the consumer to less than

5 percent and hence comply with the DWSNZ depends only upon the number of samples taken. For example, if two transgressions are recorded, so long as at least 107 other samples (giving a total of 109) have not exceeded the MAV, the risk to the consumer is less than 5 percent irrespective of the period over which the samples were collected.

For the purposes of compliance, however, it is necessary to set a time period within which the statistics are to be applied. The reason for this is demonstrated by considering a situation in which 48 samples are collected per year for three years (total 144 samples), and that only two of these samples exceed the MAV, both in the last two months of sampling. When the whole three years is considered, the risk to the consumer is less than 5 percent because a maximum of three transgressions is allowed for 144 samples (see the first Bayesian column in Table A1.1). However, the fact that both transgressions occur in a short period indicates that there may well be a water quality problem that has developed near the end of the three-year period. This possible problem is correctly identified if a shorter period for assessing compliance is defined: for example, one year. Now, for the first two years in which there were no transgressions, the number of samples taken meets the requirements of Table A1.1 (a minimum of 38 samples taken if there is no exceedance). The supply does not comply in the last year however, because there are two transgressions during this year, and Table A1.1 requires a minimum of 109 samples to have been taken to reduce the consumer's risk to less than 5 percent.

For the purposes of the DWSNZ, the period over which compliance is assessed has been indexed to the community size, as has the sampling frequency, which should assist in minimising these issues.

## Compliance for small supplies

Small supplies have been given the benefit of the doubt to allow a reduction in the burden that collection of 38 samples a year would otherwise place on them. In doing this it is assumed that 12 non-transgressions indicates no transgressions at least 95 percent of the time. However, in the event that one sample exceeds the MAV, there is evidence that the 95th percentile standard may not be being met, and further sampling requirements set out in the DWSNZ must be followed.

## Compliance for other supplies

Table A1.2 lists the number of exceedances that can be tolerated for 95 percent confidence that a benchmark is not being exceeded more than 5 percent of the time.

The table refers to the number of samples, irrespective of the frequency of sampling. Thus, the number of permissible transgressions in 250 samples is the same (seven) whether all 250 samples were collected in one day or taken over the course of a year.

**Table A1.2: Allowable exceedances (for 95 percent confidence that the MAV is exceeded for no more than 5 percent of the time)**

| <i>e</i> | <i>n</i>  | <i>e</i> | <i>n</i>  | <i>e</i> | <i>n</i>  | <i>e</i> | <i>n</i>  |
|----------|-----------|----------|-----------|----------|-----------|----------|-----------|
| 0        | 38–76     | 40       | 1025–1046 | 80       | 1908–1929 | 120      | 2773–2793 |
| 1        | 77–108    | 41       | 1047–1069 | 81       | 1930–1951 | 121      | 2794–2815 |
| 2        | 109–138   | 42       | 1070–1091 | 82       | 1952–1973 | 122      | 2816–2836 |
| 3        | 139–166   | 43       | 1092–1113 | 83       | 1974–1994 | 123      | 2837–2858 |
| 4        | 167–193   | 44       | 1114–1136 | 84       | 1995–2016 | 124      | 2859–2879 |
| 5        | 194–220   | 45       | 1137–1158 | 85       | 2017–2038 | 125      | 2880–2900 |
| 6        | 221–246   | 46       | 1159–1181 | 86       | 2039–2060 | 126      | 2901–2922 |
| 7        | 247–272   | 47       | 1182–1203 | 87       | 2061–2081 | 127      | 2923–2943 |
| 8        | 273–298   | 48       | 1204–1225 | 88       | 2082–2103 | 128      | 2944–2965 |
| 9        | 299–323   | 49       | 1226–1247 | 89       | 2104–2125 | 129      | 2966–2986 |
| 10       | 324–348   | 50       | 1248–1270 | 90       | 2126–2146 | 130      | 2987–3007 |
| 11       | 349–372   | 51       | 1271–1292 | 91       | 2147–2168 | 131      | 3008–3029 |
| 12       | 373–397   | 52       | 1293–1314 | 92       | 2169–2190 | 132      | 3030–3050 |
| 13       | 398–421   | 53       | 1315–1336 | 93       | 2191–2211 | 133      | 3051–3072 |
| 14       | 422–445   | 54       | 1337–1358 | 94       | 2212–2233 | 134      | 3073–3093 |
| 15       | 446–469   | 55       | 1359–1381 | 95       | 2234–2255 | 135      | 3094–3114 |
| 16       | 470–493   | 56       | 1382–1403 | 96       | 2256–2276 | 136      | 3115–3136 |
| 17       | 494–517   | 57       | 1404–1425 | 97       | 2277–2298 | 137      | 3137–3157 |
| 18       | 518–541   | 58       | 1426–1447 | 98       | 2299–2320 | 138      | 3158–3178 |
| 19       | 542–564   | 59       | 1448–1469 | 99       | 2321–2341 | 139      | 3179–3200 |
| 20       | 565–588   | 60       | 1470–1491 | 100      | 2342–2363 | 140      | 3201–3221 |
| 21       | 589–611   | 61       | 1492–1513 | 101      | 2364–2384 | 141      | 3222–3243 |
| 22       | 612–635   | 62       | 1514–1535 | 102      | 2385–2406 | 142      | 3244–3264 |
| 23       | 636–658   | 63       | 1536–1557 | 103      | 2407–2427 | 143      | 3265–3285 |
| 24       | 659–681   | 64       | 1558–1579 | 104      | 2428–2449 | 144      | 3286–3307 |
| 25       | 682–704   | 65       | 1580–1601 | 105      | 2450–2471 | 145      | 3308–3328 |
| 26       | 705–727   | 66       | 1602–1623 | 106      | 2472–2492 | 146      | 3329–3349 |
| 27       | 728–751   | 67       | 1624–1645 | 107      | 2493–2514 | 147      | 3350–3371 |
| 28       | 752–774   | 68       | 1646–1667 | 108      | 2515–2535 | 148      | 3372–3392 |
| 29       | 775–796   | 69       | 1668–1689 | 109      | 2536–2557 | 149      | 3393–3413 |
| 30       | 797–819   | 70       | 1690–1711 | 110      | 2558–2578 | 150      | 3414–3434 |
| 31       | 820–842   | 71       | 1712–1733 | 111      | 2579–2600 | 151      | 3435–3456 |
| 32       | 843–865   | 72       | 1734–1755 | 112      | 2601–2621 | 152      | 3457–3477 |
| 33       | 866–888   | 73       | 1756–1776 | 113      | 2622–2643 | 153      | 3478–3498 |
| 34       | 889–910   | 74       | 1777–1798 | 114      | 2644–2664 | 154      | 3499–3520 |
| 35       | 911–933   | 75       | 1799–1820 | 115      | 2665–2686 | 155      | 3521–3541 |
| 36       | 934–956   | 76       | 1821–1842 | 116      | 2687–2707 | 156      | 3542–3562 |
| 37       | 957–978   | 77       | 1843–1864 | 117      | 2708–2729 | 157      | 3563–3583 |
| 38       | 979–1001  | 78       | 1865–1886 | 118      | 2730–2750 | 158      | 3584–3605 |
| 39       | 1002–1024 | 79       | 1887–1907 | 119      | 2751–2772 | 159      | 3606–3626 |

Note: 'e' is the maximum permissible number of exceedances of a 95 percentile limit for the stated range of samples 'n'. Calculations have been made using the theory stated in McBride and Ellis (2001), using 'Jeffreys' prior'. (See also McBride 2005, section 8.4.)

## A2 Handling non-detects

New Zealand chemical analysts routinely define a detection limit or limit of detection as some multiple (typically between 2 and 4) of the standard deviation of a series of blanks, and report all data measured below that limit as less than that limit. Let's denote the detection limit by  $L$ . Three cases should be considered.

- 1 **Few less-than data.** When a dataset contains only a few data (say <10 percent) below  $L$ , analysis of those data can proceed by replacing those (left-censored) data by  $\frac{1}{2}L$ . This is a generally satisfactory procedure (Ellis 1989).
- 2 **A moderate amount of less-than data.** If there are a moderate number of censored data, replacement by  $\frac{1}{2}L$  is unsatisfactory. Instead, use a statistical distribution fitting method (Helsel and Hirsch 1992, and Helsel 2005), as depicted on Figure A1, ie:
  - fit a plausible statistical distribution to the data above  $L$  (eg, using a probability plot)
  - extrapolate that distribution below  $L$  to fill-in values below  $L$
  - add up the concentrations.
- 3 **Mostly, or all, less-than data.** If there are many less-thans in a dataset neither of the above procedures can be used. For example, take a set of results for ten individual chemicals: <0.1, <0.1, <0.1, <0.1, <0.1, <0.1, <0.1, <0.1, 0.8, <0.1. What then is the total? Replacing each '<0.1' by 0.1 is implausible (could all nine less-thans really be 'knocking at the door?'), and we should not fit a distribution to just one datum.<sup>12</sup> Even replacement by 0.05 seems implausible.

Taking data at face-value we could say that the range of total concentration is 0.8–1.7, where the former figure is obtained by replacing all the censored data by zeroes and the latter figure by replacing those data by the detection limits. Beyond that little statistical help is available, and one must rely on plausibility arguments. One should also note that it is much better practice to analyse the compounds with a method that has a lower limit of detection, reducing the number of measurements if budgets are limited.

<sup>12</sup> Actually, we can: *any* distribution fits just one datum!

**Figure A2: Fitting a lognormal distribution to >L data (where L = 5), and extrapolating back to obtain values of <L data**

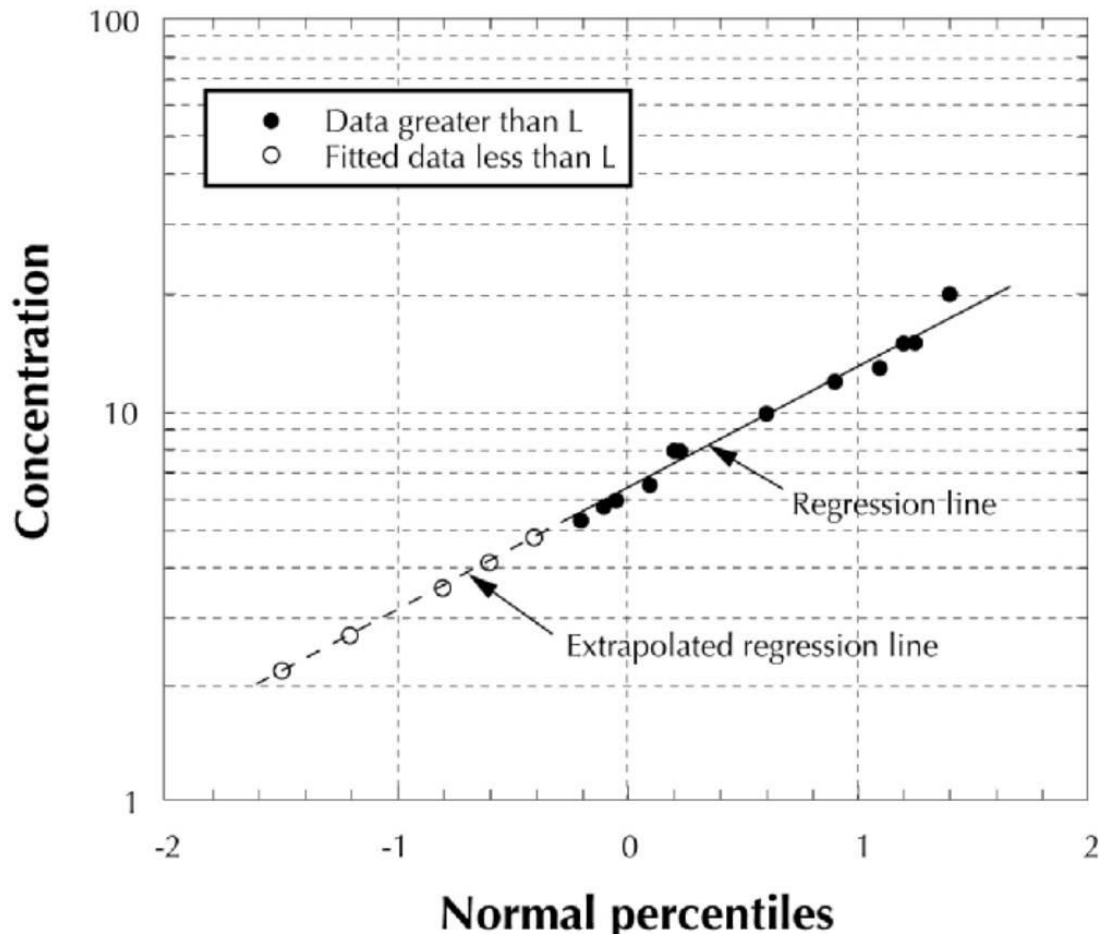

Each fill-in value (open circles) is selected randomly from the left tail of a lognormal distribution.

## References

Australian DoH. 2011. *Guidance on Use of Rainwater Tanks: Preventing Impacts on Aesthetic Quality*. Department of Health.  
<http://www.health.gov.au/internet/publications/publishing.nsf/Content/ohp->

## enhealth-raintank-cnt-l~ohp-enhealth-raintank-cnt-l-5~ohp-enhealth-raintank-cnt-l-5.7

Ball A. 2007. *Estimation of the Burden of Waterborne Disease in New Zealand: Preliminary report*. Christchurch: ESR.

Baker M, Russell N, Roseveare C, et al. 1998. Outbreak of cryptosporidiosis linked to Hutt Valley swimming pool. *The New Zealand Public Health Report* 5(6): 41–5.

Bartram J. 2003. Investigation of sporadic waterborne disease. Preface to section 3 (on Investigation of Sporadic Waterborne Disease) in PR Hunter, M Waite, E Ronchi. 2003. *Drinking Water and Infectious Disease*. Boca Raton, LA: CRC Press and IWA Publishing.

Beca. 2001. *Drinking Water Compliance Assessment*. A report prepared (in March) for the Ministry of Health by Beca Steven in association with BERL.

Brieseman MA. 1987. Town water supply as the cause of an outbreak of *Campylobacter* infection. *New Zealand Medical Journal* 100: 212–13.

CH2M Beca. 2010. *Drinking Water Standards New Zealand Cost Benefit Analysis – Engineering Input*. 103 pp. <http://www.health.govt.nz/publication/drinking-water-cost-benefit-analysis>

Craun G, Till DG, McBride GB. 2004. Epidemiological studies and surveillance. Chapter 10 in: JA Cotruvo, A Dufour, G Rees, et al. *Waterborne Zoonoses: Identification, Causes and Control*. London: IWA Publishing, for the World Health Organization. Available at: [http://www.who.int/water\\_sanitation\\_health/diseases/zoonoses/en/](http://www.who.int/water_sanitation_health/diseases/zoonoses/en/)

Duncanson M, Russell N, Weinstein P, et al. 2000. Rates of notified cryptosporidiosis and quality of drinking water supplies in Aotearoa, New Zealand. *Water Research* 14(15): 3804–12.

Dupont DP, Jahan N. 2012. Defensive spending on tap water substitutes: the value of reducing perceived health risks. *J Water and Health* 10(1): 56–68.

Eberhardt-Phillips J, Walker N, Garrett N, et al. 1997. Campylobacteriosis in New Zealand: results of a case-control study. *Journal of Epidemiology and Community Health* 51: 686–91.

Ellis JC. 1989. *Handbook on the Design and Interpretation of Monitoring Programmes*. Water Research Centre Report NS29. England: Medmenham.

ESR. *Annual Summary of Outbreaks in New Zealand*. Wellington: ESR. See [www.surv.esr.cri.nz](http://www.surv.esr.cri.nz) then select surveillance reports, annual surveillance summary for the year desired, and then selected tables.

Fraser G, Cooke KR. 1991. Endemic giardiasis and municipal water supply. *American Journal of Public Health* 81(6): 760–2.

Frost F, Calderon RL, Craun GF. 2003. Improving waterborne disease surveillance. Chapter 2 in FW Pontius (ed) *Drinking Water Regulation and Health*. New York, NY: Wiley-Interscience.

Harrington W, Krupnick A, Spofford W. 1985. The benefits of preventing an outbreak of giardiasis due to drinking water contamination. *Resources for the Future Report*.

Washington: US Environmental Protection Agency, National Center for Environmental Economics.

Helsel DR, Hirsch RM. 1992. *Statistical Methods in Water Resources. Studies in Environmental Science* 49. Amsterdam: Elsevier. Chapter 13.

Helsel DR. 2005. *Nondetects and Data Analysis: Statistics for censored environmental data*. New York: Wiley.

Hrudey SE, Hrudey E. 2004. *Safe Drinking Water: Lessons from Recent Outbreaks in Affluent Nations*. London: IWA Publishing.

Hrudey SE. 2017. *Converting Hindsight into Foresight. Evidence prepared for Water New Zealand for submission to Government Inquiry into North Havelock Drinking-Water*. 60 pp. [https://www.dia.govt.nz/diawebsite.nsf/Files/Havelock-North-Submissions/\\$file/Havelock-Submissions-Hrudey-Mar-31.pdf](https://www.dia.govt.nz/diawebsite.nsf/Files/Havelock-North-Submissions/$file/Havelock-Submissions-Hrudey-Mar-31.pdf)

Hunter P, Waite M, Ronchi E. 2003. *Drinking Water and Infectious Disease: Establishing the Links*. London: CRC Press Boca Raton and IWA Publishing.

Hutton G, Haller L. 2004. *Evaluation of the Costs and Benefits of Water and Sanitation Improvements at the Global Level*. WHO/SDE/WSH/04.04. Geneva: WHO. See: [http://www.who.int/water\\_sanitation\\_health/wsh0404/en/](http://www.who.int/water_sanitation_health/wsh0404/en/)

IANZ. 2000. *General Requirements for the Competence of Testing and Calibration Laboratories* (NZS/ISO/IEC 17025).

IANZ. 2007. *Supplementary Criteria for Accreditation No. 1.2/2.2* (2nd edition). Auckland: Ministry of Health Register of Water Testing Laboratories, International Accreditation New Zealand. See: <http://www.ianz.govt.nz>

Ionas G, Learmonth JJ, Keys EA, et al. 1999. Distribution of *Giardia* and *Cryptosporidium* in natural water systems in New Zealand – a nationwide survey. *Water Science and Technology* 38(12): 57–60.

Lake R, Adlam B, Perera S. 2009. *Acute Gastrointestinal Illness (AGI) Study: Final study report*. Christchurch: ESR.

LECG. 2010. *Cost Benefit Analysis of Raising the Quality of New Zealand Networked Drinking Water*. Report to the Ministry of Health. 274 pp. <http://www.health.govt.nz/publication/drinking-water-cost-benefit-analysis>

McBride GB, Ellis JC. 2001. Confidence of compliance: a Bayesian approach for percentile standards. *Water Research* 35(5): 1117–24.

McBride GB. 2005. *Using Statistical Methods for Water Quality Management: Issues, Options and solutions*. New York: Wiley.

McBride G, Till D, Ryan T, et al. 2002. *Freshwater Microbiology Research Report: Pathogen occurrence and human health risk assessment analysis*. Wellington: Ministry for the Environment.

McElnay C, Inkson I. 2002. Outbreak of *Campylobacter* in Hawke's Bay traced to school water supply. In: *Annual Summary of Outbreaks in New Zealand 2001: A report to the Ministry of Health*. Wellington: Institute of Environmental Science and Research Limited (ESR).

- Ministry of Health. 1992 to present day. *Annual Reviews of Drinking-water Quality in New Zealand*. Wellington: Ministry of Health.
- Ministry of Health. 1993 to present day. *Register of Community Drinking-water Supplies and Suppliers in New Zealand*. Wellington: Ministry of Health.
- Ministry of Health. 1995, 2000, 2005, 2008 and 2018. *Drinking-water Standards for New Zealand*. Wellington: Ministry of Health.
- Ministry of Health. 2001. *How to Prepare and Develop Public Health Risk Management Plans for Drinking-water Supplies*. Wellington: Ministry of Health.
- Ministry of Health. 2008. *Guidelines for the Safe Carriage and Delivery of Drinking-water*. <https://www.health.govt.nz/publication/guidelines-safe-carriage-and-delivery-drinking-water>
- Ministry of Health. 2015. *Rural Agricultural Drinking-water Supply Guideline*. Wellington: Ministry of Health. 12 pp. <http://www.health.govt.nz/publication/rural-agricultural-drinking-water-supply-guideline>
- Ministry of Health. 2018. New Zealand Drinking-water Safety Plan Framework. <https://www.health.govt.nz/publication/new-zealand-drinking-water-safety-plan-framework>
- Nokes C, Devane M, Scholes P, et al. 2004. Survey of *Campylobacter* in New Zealand's treated drinking waters. *Proceedings of the New Zealand Water and Wastes Annual Conference and Expo*. Christchurch, 6–8 October.
- OECD. 2011. *Benefits of Investing in Water and Sanitation: An OECD perspective*. OECD Publishing. 151 pp. <http://dx.doi.org/10.1787/9789264100817-en>
- Ogilvie DJ. 1989. Water supply questionnaire, disinfection and bacteriology. *New Zealand Water Supply and Disposal Association Newsletter* (now *New Zealand Water & Wastes Association Journal*). Part I, issue #55: 8–14; Part II, issue #56: 19–26; Part III, issue #57: 20–4.
- OMS. 2004. *Assistance Options for Safer Drinking Water Systems: Report to the Ministry of Health*. Wellington: Outcome Management Services Ltd.
- Payment P, Hunter P. 2003. Intervention studies. In PR Hunter, M Waite, E Ronchi. 2003. *Drinking Water and Infectious Disease*. Boca Raton, LA: CRC Press and IWA Publishing.
- Percival S, Chalmers R, Embrey M, et al. 2004. *Microbiology of Water-borne Diseases*. Amsterdam: Elsevier Academic Press.
- Pretty JN, Brett C, Gee D, et al. 2000. An assessment of the total external costs of UK agriculture. *Agricultural Systems* 65: 113–36.
- Queensland Government. 2018. Fire Retardants and Health. <https://www.qld.gov.au/health/staying-healthy/environmental/after-a-disaster/bushfires/fire-retardants-and-health>
- Reilly WJ, Browning LM. 2004. Zoonoses in Scotland – food, water, or contact? Chapter 11 in JA Cotruvo, A Dufour, G Rees, et al (eds.). *Waterborne Zoonoses Identification, Causes and Control*. London: IWA Publishing, for the World Health



Organization, pp 167–190. Available at:

[http://www.who.int/water\\_sanitation\\_health/diseases/zoonoses/en/](http://www.who.int/water_sanitation_health/diseases/zoonoses/en/)

Reimann C, Banks D. 2004. Setting action levels for drinking water: are we protecting our health or our economy (or our backs!). *Science of the Total Environment* 332: 12–21.

Sapere Research. 2013. *The 2012 Waterborne Disease Outbreak in a Small Town in New Zealand: An estimate of costs*. Report prepared by the Sapere Research Group for the Ministry of Health. 55 pp.

Sapere Research. 2017. *The Economic Costs of the Havelock North August 2016 Waterborne Disease Outbreak*. Report prepared by the Sapere Research Group for the Ministry of Health. 68 pp. <https://www.health.govt.nz/publication/economic-costs-havelock-north-august-2016-waterborne-disease-outbreak>

Savill MG, Hudson JA, Ball A, et al. 2001. Enumeration of *Campylobacter* in New Zealand recreational and drinking waters. *Journal of Applied Microbiology* 91: 38–46.

Schuster CJ, Aramini JJ, Ellis AG, et al. 2005. Infectious disease outbreaks related to drinking water in Canada 1974–2001. *Revue Canadienne de Santé Publique* 96(4): 254–8.

Shaw CP. 1993. *The New Zealand Drinking-water Standards – a preview*. New Zealand Water and Wastes Association Annual Conference, September.

Simmons G, Hope V, Lewis G, et al. 2001. Contamination of potable roof-collected rainwater in Auckland, New Zealand. *Water Research* 35(6): 1518–24.

Sneyd E, Baker M. 2003. *Infectious Diseases in New Zealand: 2002 annual surveillance summary*. ESR Client Report FW 0332, for New Zealand Ministry of Health.

Stehr-Green JK, Nicholls C, McEwan S, et al. 1991. Waterborne outbreak of *Campylobacter jejuni* in Christchurch: the importance of a combined epidemiologic and microbiologic investigation. *New Zealand Medical Journal* 104: 356–8.

Thorstensen AL. 1985. *What happened at Queenstown – an object lesson for water supply authorities*. New Zealand Local Government, February, p 455.

Till DG, McBride GB. 2004. Potential public health risk of *Campylobacter* and other zoonotic waterborne infections in New Zealand. Chapter 12 in: JA Cotruvo, A Dufour, G Rees, et al. *Waterborne Zoonoses: Identification, Causes and Control*. London: IWA Publishing, for the World Health Organization. Available at: [http://www.who.int/water\\_sanitation\\_health/diseases/zoonoses/en/](http://www.who.int/water_sanitation_health/diseases/zoonoses/en/)

Taylor MEU. 1993a. *Review of the Management of Drinking-water Quality in New Zealand*. New Zealand Water and Wastes Association Annual Conference, September.

Taylor MEU. 1993b. *Drinking-water for the 21st Century*. The second annual AIC Water Resources Industry Conference, Auckland, July.

Taylor MEU. 2000. Drinking-water management in New Zealand. *Water (J Australian Water and Waste Association)*, November issue.

Taylor M, Ball A. 2004. Why do we need safe water? Unpublished paper presented to the New Zealand Environment Summit, Wellington, 22 March 2004.

USEPA. 2003. *Small Drinking Water Systems Handbook: A guide to 'packaged' filtration and disinfection technologies with remote monitoring and control tools*. EPA/600/R-03/041. Office of Research and Development. Water Supply and Water Resources Division, United States Environmental Protection Agency. 73 pp.

<http://www.epa.gov/nrmrl/pubs/600r03041/600r03041.htm> now go to:

<http://nepis.epa.gov/Exe/ZyNET.exe/100046K6.TXT?ZyActionD=ZyDocument&Client=EPA&Index=2000+Thru+2005&Docs=&Query=&Time=&EndTime=&SearchMethod=1&TocRestrict=n&Toc=&TocEntry=&QField=&QFieldYear=&QFieldMonth=&QFieldDay=&IntQFieldOp=0&ExtQFieldOp=0&XmlQuery=&File=D%3A%5Czyfiles%5CIndex%20Data%5C00thru05%5CTxt%5C00000006%5C100046K6.txt&User=ANONYMOUS&Password=anonymous&SortMethod=h%7C-&MaximumDocuments=1&FuzzyDegree=0&ImageQuality=r75g8/r75g8/x150y150g16/i425&Display=p%7Cf&DefSeekPage=x&SearchBack=ZyActionL&Back=ZyActionS&BackDesc=Results%20page&MaximumPages=1&ZyEntry=1&SeekPage=x&ZyPURL>

Victoria State Govt. 2015. *Fire Retardants and Health*.

<https://www2.health.vic.gov.au/public-health/environmental-health/environmental-health-in-the-community/fire-retardants-and-health>

Wheeler JG, Sethi D, Cowden JM, et al. 1999. Study of infectious intestinal disease in England: rates in the community, presenting to general practice, and reported to national surveillance. *British Medical Journal* 318(7190): 1046–50.

WHO. 2004. *Guidelines for Drinking-water Quality* (3rd edition). Geneva: World Health Organization. Available at:

[www.who.int/water\\_sanitation\\_health/dwq/gdwq3/en/print.html](http://www.who.int/water_sanitation_health/dwq/gdwq3/en/print.html) see also the addenda.

WHO. 2005. *International Health Regulations (IHR)*. Geneva: World Health Organization. 82 pp. <http://www.who.int/ihr/9789241596664/en/index.html>

WHO. 2007. *International Health Regulations, Guide to Ship Sanitation* (3rd edition) draft, Version 10. Geneva: World Health Organization. 178 pp. Final version due December 2010.

[http://www.who.int/water\\_sanitation\\_health/gdwqrevision/rrships/en/index.html](http://www.who.int/water_sanitation_health/gdwqrevision/rrships/en/index.html)

WHO. 2009. *Guide to Hygiene and Sanitation in Aviation* (3rd edition). Geneva: World Health Organization. 71 pp. See for general links:

[http://www.who.int/ihr/ports\\_airports/en/](http://www.who.int/ihr/ports_airports/en/) and also:

[http://www.who.int/water\\_sanitation\\_health/gdwqrevision/aviation/en/index.html](http://www.who.int/water_sanitation_health/gdwqrevision/aviation/en/index.html)

[http://www.who.int/water\\_sanitation\\_health/hygiene/ships/guide\\_hygiene\\_sanitation\\_aviation\\_3\\_edition.pdf](http://www.who.int/water_sanitation_health/hygiene/ships/guide_hygiene_sanitation_aviation_3_edition.pdf)

WHO. 2011. *Guidelines for Drinking-water Quality 2011* (4th edition). Geneva: World Health Organization. Available at:

[http://www.who.int/water\\_sanitation\\_health/publications/2011/dwq\\_guidelines/en/index.html](http://www.who.int/water_sanitation_health/publications/2011/dwq_guidelines/en/index.html)

WHO. 2011a. *Guide to Ship Sanitation* (3rd edition). Geneva: World Health Organization. 171 pp.

[http://whqlibdoc.who.int/publications/2011/9789241546690\\_eng.pdf](http://whqlibdoc.who.int/publications/2011/9789241546690_eng.pdf)

WHO. 2017. Guidelines for drinking-water quality: fourth edition incorporating the first Addendum. Geneva: World Health Organization. 631 pp.

[http://www.who.int/water\\_sanitation\\_health/publications/drinking-water-quality-guidelines-4-including-1st-addendum/en/](http://www.who.int/water_sanitation_health/publications/drinking-water-quality-guidelines-4-including-1st-addendum/en/)

WRC. 1998. *Wholesale Water Supply Risk Analysis Discussion Paper*. Wellington Regional Council.

# Chapter 2: Management of community supplies

## Contents

|            |  |           |
|------------|--|-----------|
| <b>2.1</b> | <b>Introduction</b>                                  | <b>2</b>  |
| 2.1.1      | Components of a drinking-water supply                | 3         |
| 2.1.2      | Overview of management systems                       | 6         |
| <b>2.2</b> | <b>Risk management</b>                               | <b>8</b>  |
| 2.2.1      | General  | 8         |
| 2.2.2      | Water Safety Plans (WSPs)                            | 11        |
| 2.2.3      | Contingency planning                                 | 29        |
| 2.2.4      | Response to incidents                                | 31        |
| 2.2.5      | Debriefings  | 33        |
| 2.2.6      | Sanitary surveys                                     | 34        |
| 2.2.7      | Staff and contractors                                | 35        |
| <b>2.3</b> | <b>Quality assurance</b>                             | <b>37</b> |
| 2.3.1      | Key features of quality assurance                    | 37        |
| 2.3.2      | Application to drinking-water supplies               | 38        |
| <b>2.4</b> | <b>Quality control</b>                               | <b>40</b> |
| <b>2.5</b> | <b>Quantitative microbial risk assessment (QMRA)</b> | <b>41</b> |
|            | <b>References</b>                                    | <b>44</b> |

## List of tables

|            |  |    |
|------------|--|----|
| Table 2.1: | Supply elements contributing to the four main barriers to bacterial contaminants | 19 |
|------------|--|----|

## List of figures

|             |   |    |
|-------------|---|----|
| Figure 2.1: | Schematic diagram of a drinking-water supply system | 4  |
| Figure 2.2: | Integrated management of water supply systems       | 7  |
| Figure 2.3: | The risk management process                         | 9  |
| Figure 2.4: | Suggested approach for the development of WSPs      | 18 |
| Figure 2.5: | Process for the implementation of WSPs              | 25 |
| Figure 2.6: | Organisation of incident management teams           | 32 |
| Figure 2.7: | Basic structure for a quality management system     | 38 |

## 2.1 Introduction

This chapter discusses good management practices for community drinking-water supplies. A community drinking-water supply is a reticulated, publicly or privately owned, drinking-water supply connecting at least two buildings on separate titles, and serving at least 1500 person days a year (eg, 25 people at least 60 days per year). An integrated management system should be designed to meet the requirements of the *Drinking-water Standards for New Zealand 2005 (revised 2008)* (DWSNZ), statutory requirements and the consumers' needs, as well as environmental and cultural considerations.

The most important constituents of drinking-water are undoubtedly those that are capable of having a direct impact on public health. It is up to the water suppliers to demonstrate to their consumers that the management of the water supply system is being undertaken in a responsible and efficient manner.

The proper management of a water supply system includes:

- 1 awareness and understanding of the physical and operational components of the system
- 2 adopting risk, quality assurance and asset management procedures in the operation of the water supply
- 3 maintaining a surveillance programme to confirm that all systems are operating effectively
- 4 establishing a preventive and remedial actions programme
- 5 establishing effective monitoring programmes to test compliance with the drinking-water quality standards
- 6 being aware of the requirements set down by statutory and consumer needs
- 7 having the ability to respond to consumer and community needs
- 8 establishing communication lines and techniques.

This chapter covers items 2–4 in some detail, and necessarily overlaps with items 1 and 5–8, which are covered in other chapters.

Chapters 3 and 4 cover the selection and protection of water sources; Chapters 5–11 cover compliance issues; Chapters 12–15 discuss treatment processes (including disinfection); Chapter 16 discusses distribution system operations and maintenance. Chapter 17 covers monitoring. Consumer satisfaction is important, especially with respect to the aesthetic quality of the water supply, refer Chapter 18: aesthetic considerations. Management of small supplies appears in Chapter 19.

Some management issues are covered in ANSI/AWWA Standards G series, see list on <http://www.awwa.org/files>

EnHealth (2012) developed a risk resource to help local governments in Australia manage environmental health risks, including water supplies. The resource raises awareness of how to minimise the financial, health and reputation risks related to the environmental health responsibilities of local governments.

Water Research Australia (WRA 2015) produced a good practice guide for water supply management laid out in a user friendly format of check points and actions.

Water safety plans (WSPs) contribute to improved O&M by supporting the systematic assessment, prioritisation and management of risks from catchment to consumer, including those related to inadequate O&M. **Operations** refers to the day-to-day “running” of a water supply system under normal or emergency conditions. **Maintenance** involves (a) scheduled or planned activities under normal operating conditions to maintain operational systems, equipment and assets essential to supplying safe water to consumers (including the catchment, raw water storage, abstraction, treatment, distribution and customer interface); and (b) unscheduled activities during unforeseen or emergency situations to bring the water supply system back to normal operating conditions. Most maintenance activities require engagement of operational personnel. **O&M are central to successful implementation of WSPs.** Identifying O&M-related hazards, determining and validating associated control measures, monitoring those control measures, preparing standard operating procedures (SOPs) for O&M activities and ensuring sufficient training for O&M staff are essential components of a WSP. The full benefits of a WSP cannot be realised without these key O&M processes. **WSPs drive O&M improvements.** The risk assessment process that underpins WSPs is a mechanism to identify any gaps in a water supply system’s O&M practices and the control measures required to manage risk to water quality and service delivery. This gap analysis becomes the platform to drive O&M process improvements (WHO 2018).

## 2.1.1 Components of a drinking-water supply

The principal features of a drinking-water supply are shown in Figure 2.1, which is reproduced from section 1.8 of the DWSNZ. The format for the information on drinking-water supplies published in the Ministry’s *Register of Community Drinking-water Supplies and Suppliers in New Zealand* is based on the schematic approach illustrated in Figure 2.1.

A community water supply comprises one or more of the following (see Figure 2.1):

- the source of raw water
- the treatment plant
- the distribution system.

Individual components and chemicals used in the water supply need to be appropriate, ie, should not compromise the quality of the water. New Zealand, Australian, UK, ISO and US standards should be referred to where possible. Examples include:

- List of Approved Products for Use in Public Water Supply in the United Kingdom, see <http://dwi.defra.gov.uk/drinking-water-products/approved-products/soslistcurrent.pdf>
- AS/NZS 4020:1999. Products for use in contact with drinking water.

**Figure 2.1: Schematic diagram of a drinking-water supply system**

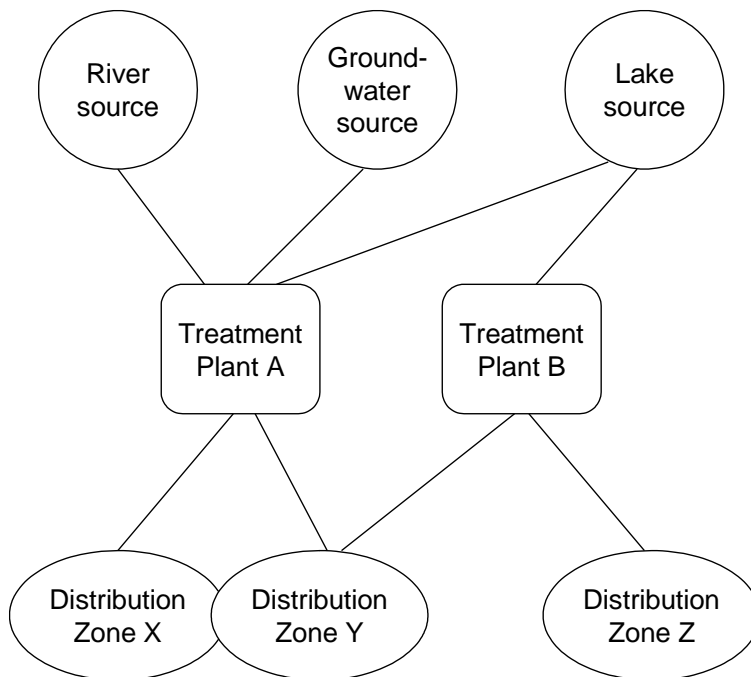

### 2.1.1.1 Source water

A community water supply may abstract raw water from rainwater, surface water or groundwater sources. These are discussed in Chapters 3 and 4; Chapter 8 which describes the source water categories for *Cryptosporidium*; and Chapter 19 which focuses on small water supplies, including rainwater supplies.

Surface water is frequently contaminated by micro-organisms. Waters from shallow groundwater sources and springs are microbiologically equivalent to surface water, along with rivers, streams, lakes and reservoirs. Secure bore water is considered to be free from microbiological (bacterial and protozoal) contamination, see Chapter 3.

A water supply may have more than one source of raw water. Secondary sources may be permanent or temporary. Temporary water supplies are discussed in section 6.8 of WHO (2011). Tankered water is covered by the *Guidelines for the Safe Carriage and Delivery of Drinking-water* (MoH 2008).

### 2.1.1.2 The treatment plant

A treatment plant is a facility that treats raw water to make it safe and palatable for drinking. To harmonise the DWSNZ with the conventions used in the public health grading of community drinking-water supplies, the treatment plant is considered to be that part of the system where raw water becomes the drinking-water. This can range from a full-scale water treatment plant comprising chemical coagulation, sedimentation, sand filtration, pH adjustment, disinfection and fluoridation, to simply being the point in a pipeline where the water main changes from a raw water main to a drinking-water supply main. In a simple water supply, the water may be merely abstracted from a river, passed through a coarse screen and piped to town; thus the water supply acts like a diverted stream. If the raw water is chlorinated, however, it will not be considered to become drinking-water until it has been exposed to chlorine (or chlorine dioxide) for the design contact time.

A treatment plant may receive raw water from more than one source.

Water treatment and disinfection processes are discussed in Chapters 12–15.

### 2.1.1.3 The distribution system

Once the water leaves the water treatment plant, it enters one or more distribution zone(s) that serve the community. The DWSNZ and the Public Health Grading of drinking-water supplies define a distribution zone as:

“the part of the water supply network within which all consumers receive drinking-water of identical quality, from the same or similar sources, with the same treatment and usually at the same pressure. It is part of the supply network that is clearly separated from other parts of the network, generally by location, but in some cases by the layout of the pipe network. For example, in a large city, the central city area may form one zone, with outlying suburbs forming separate zones, or in a small town, the system may be divided into two distinct areas. The main purpose of assigning zones is to separately grade parts of the system with distinctly different characteristics.”

A distribution zone may receive water from more than one treatment plant. The distribution system may comprise more than one distribution zone. See Figure 2.1.

Distribution zones are distinguished because they may:

- be fed by a pumping station so that they are isolated from nearby zones by pressure
- be fed from a service reservoir which can markedly increase the retention time
- vary seasonally due to supplementary sources being used at peak draw-off times
- the boundaries may vary due to changes in pressure or draw-off



- vary due to the materials used in common sections of the distribution system
- receive their water from another supply by tanker that pumps the water into a storage tank
- receive their drinking-water from a water supply wholesaler via bulk mains.

The distribution zones selected for the Public Health Grading and the DWSNZ are based on water quality considerations and will not necessarily coincide with the distribution zones which the water suppliers identify for operational and management purposes. Many community drinking-water supplies comprise one distribution zone only.

The distribution system is discussed in Chapter 16.

## 2.1.2 Overview of management systems

There are a number of concepts and techniques that are useful for the management of water supply systems. These include:

- risk management (as outlined in section 2.2), which involves identifying, controlling and minimising the impact of uncertain events
- quality assurance (as outlined in section 2.3) which is based on controlling processes to provide consistent products that satisfy customer requirements
- quality control measures (as outlined in section 2.4), which provides the checks to demonstrate the product is complying with standards, and feedback to the adequacy of risk management
- asset management, which involves the management of assets to achieve the required levels of service.

From the time the *Drinking Water Standards for New Zealand 1995* were prepared, the emphasis of the Ministry of Health has shifted from quality assurance to risk management.

Quality assurance techniques were first devised for the control of manufacturing processes. They aim to ensure a consistently acceptable end product by understanding and controlling the processes used to produce that product. Quality assurance techniques recognise that there will be a percentage of products that do not comply with the specified requirements and concentrates on reducing this quantity to an economically acceptable level. Whilst this approach offers many benefits, it is not completely suitable for the management of water supplies, where the release of even a very small amount of contaminated water can impact on public health, and cause economic and social impacts.

Risk management on the other hand concentrates on identifying, controlling and minimising the impact of uncertain events. Like quality assurance it recognises that sometimes things will not go as planned and aims to identify the causes of these problems and early warnings that the events are starting, and put into place measures to control their impact. Emphasis is placed on developing plans that detail how to prevent events occurring and to respond to events when they do occur.

The use of risk management principles provides a greater certainty that the water being provided to the public is safe than is given by merely monitoring compliance with standards (quality control). This approach to water supply management leads water suppliers to consider what can possibly go wrong in a water supply, to pinpoint what the causes may be, and once identified, to take actions to reduce the likelihood of the event occurring.

Whilst quality assurance and risk management techniques have different emphases, they both involve similar tasks and both techniques have a place, along with asset management techniques, in the integrated management of water supply systems, as illustrated in Figure 2.2. Risk management techniques are used to identify what can go wrong and for putting in place measures to reduce these risks. Often the measures will involve controlling the everyday work processes through quality assurance techniques. In other cases measures may involve the maintenance or upgrading of assets such as treatment plants and distribution pipes, using asset management techniques to decide when and/or how to upgrade or maintain these assets. The understanding gained from the application of quality assurance and asset management to the operation, maintenance and upgrading of the water supply system will in turn provide a better understanding of the risks that can affect the system. When this is fed back into the risk assessment the whole cycle starts again.

**Figure 2.2: Integrated management of water supply systems**

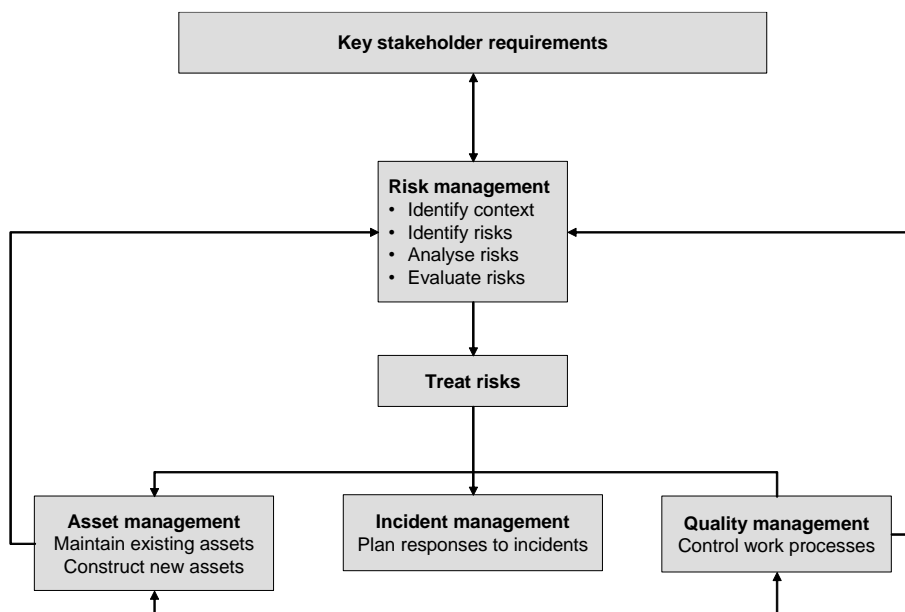

The Australian Drinking Water Guidelines (NHMRC 2016) discuss six guiding principles for assuring safe drinking water:

1. The greatest risks to consumers of drinking water are pathogenic microorganisms. Protection of water sources and treatment are of paramount importance and must never be compromised
2. The drinking water system must have, and continuously maintain, robust multiple barriers appropriate to the level of potential contamination facing the raw water supply.

3. Any sudden or extreme change in water quality, flow or environmental conditions (eg, extreme rainfall or flooding) should arouse suspicion that drinking water might become contaminated.
4. System operators must be able to respond quickly and effectively to adverse monitoring signals.
5. System operators must maintain a personal sense of responsibility and dedication to providing consumers with safe water, and should never ignore a consumer complaint about water quality.
6. Ensuring drinking water safety and quality requires the application of a considered risk management approach.

## 2.2 Risk management

### 2.2.1 General

Risk is measured in terms of:

- likelihood, ie, what is the probability or chance that the event will occur
- consequence, ie, what harm will be caused by the event.

Risk management, therefore, places emphasis on preventing events occurring (to reduce the likelihood) and responding to events when they do occur (to reduce the consequences).

WHO (2013) states that risk perception is formed by two components: hazard and outrage. Hazard (the technical, scientific aspect) combines the probability of a certain event occurring with the severity of the outcome. Outrage (the subjective part) focuses on the situation as opposed to the extent of the risks, including the nature of the risk and the way it is managed. The main components of outrage factors are the involuntary nature of the issue, the artificial (industrial) nature of the risk, the use of cover-up or silence, attempts to engage message recipients to persuade them about the issue, the occurrence of accidents, double truths around the issue, conflicts of interest, contradictory messages and inequitable distribution of risk. It has been demonstrated that a clearer perception of the risk by the population leads to a higher effectiveness of the protective measures established by health institutions. Uncertainty also plays an important role in environmental risk assessment, management and communication. Uncertainty should be acknowledged as a central component in the management of environmental risks. It is important to consider and assess uncertainties in the risk assessment process, since not doing so leads to a distortion of study conclusions. Recognition of uncertainties allows for their further reduction in future studies and unmasking in previous cases. It can also help in the taking of political and regulatory decisions.

In the case of a water supply, an event would be something that has the potential to compromise the ability to supply safe drinking water. Examples could include:

- the water supply being contaminated by faeces and people becoming sick because of drinking contaminated water
- a truck or unbunded tank spills its chemical load upstream of the intake and people becoming sick because of drinking contaminated water
- a power failure at the pump station and people becoming sick because they do not have access to enough safe water
- an operator not taking appropriate action in response to a bad water test result and people becoming sick because of drinking contaminated water. See Water UK (2010).

The concept of the process for managing risk is shown in Figure 2.3.

**Figure 2.3: The risk management process**



## Risk analysis

Risk analysis involves:

- identifying events that may introduce hazards (contaminants that can make you sick) into the water
- establishing the likelihood and consequence of each event – the risk
- determining the tolerability or acceptability of the risks
- identifying possible options to reduce the chances of the events occurring and/or the impact of the events should they occur
- balancing the costs and benefits of each option for achieving acceptable risk levels.

## Risk reduction

Risk reduction involves implementing the measures to reduce the likelihood or consequence of the events determined in the risk analysis – a proactive step. Typical measures include:

- determining the scope/tasks of the reduction measures
- assigning responsibilities to the tasks
- determining a timeline for implementing the measures
- implementing the measures
- checking that the measures have been successful.

Examples of risk reduction measures may include additional/improved treatment processes, online monitoring, or improved training.

## Readiness

Where it is not practical to completely eliminate the risk through the implementation of risk reduction measures, organisations need to be ready to deal with the risk event when it occurs – preparation for the reactive response step. This involves:

- preparing contingency plans that detail what personnel will do when a risk event occurs – measures to deal with the event itself (eg, fix the broken pipe, restore residual chlorine level) and measures to deal with the consequences of the event (eg, issue boil water notice,<sup>1</sup> alert medical services)
- establishing relationships and outlining the channels of responsibility and communication with key stakeholders, peer organisations, regulatory authorities, suppliers and service providers so that they are in a position to help during a risk event
- the training of staff in incident management techniques and their individual roles in managing incidents
- conducting exercises to train staff and test contingency plans.

## Response

When a risk event arises organisations need to be able to respond and implement quickly and effectively the contingency plans that they have already developed in readiness – a reactive step. Therefore, organisations need to conduct team exercises regularly to practise and fine tune any response processes that they have designed and prepare robust communication systems.

<sup>1</sup> Chapter 6 includes an Appendix: Boil Water Notices.

## Recovery

Recovery involves two stages:

- firstly, the measures taken to return operations to normal and put to rest any customer or community dissatisfaction
- secondly, the analysis of the event and carrying out debriefings, to learn from the event and put into place measures to reduce the likelihood of it recurring.

The results of the debriefing should be fed back into the risk analysis thus closing the cycle and allowing it to start again. Over time this will help organisations gain a better understanding of the risks that can affect their operations and they should become smarter at handling them.

For further reading on the topic of risk management, see Chapter 10 of WHO (2001), WQRA (2009) and NHMRC (2012).

## 2.2.2 Water Safety Plans (WSPs)

The Ministry of Health (MoH) introduced the concept of Public Health Risk Management Plans (PHRMPs) in 2001 for managing public health risks associated with water supplies; MoH advocated their use. The 2005 DWSNZ introduced a new section: section 10, for small water supplies. Small water supplies had the option of following the compliance criteria in sections 4, 5, 7, 8 and 9, or using section 10 which allowed a reduced monitoring regime provided water suppliers adopted a PHRMP approach. When the Health Act was amended PHRMPs were renamed Water Safety Plans (WSPs). Section 69Z of the Health Act describes the statutory requirements for WSPs.

WSPs are action plans that show how risks to public health that may arise from the drinking-water provided by the supply will be reduced. In 2012 WHO published *Water safety planning for small community water supplies step-by-step risk management guidance for drinking-water supplies in small communities*. This includes a case study, based on New Zealand publications. WHO described water safety plans as “The most effective means of consistently ensuring the safety of a drinking water supply is through the use of a comprehensive risk assessment and risk management approach that encompasses all steps in water supply from catchment to consumer”.

WHO (2005) discusses managing drinking-water quality from the catchment to the consumer. WHO (2007) was written to help users at national or local level to establish which chemicals in a particular setting should be given priority in developing strategies for risk management and monitoring of chemicals in drinking-water. WHO (2009) is a manual for developing WSPs. WHO (2011) was written to “increase confidence that safe water is consistently being delivered to consumers by ensuring that key elements in the WSP process are not overlooked and that the WSP remains up to date and is effective”. WHO (2016a) provides a structured approach to understanding surface waters and their catchments to support the identification, assessment and prioritization of the risks, and the development of management strategies for their control.

Section 2.2.2 provides background information about the approaches that the Ministry of Health has taken. It also includes subsections on the model *Public Health Risk Management Plan Guides* (the Guides), which provide generic information that can be of assistance in the preparation of water safety plans, and a discussion of the Ministry's document *How to prepare and develop Public Health Risk Management Plans* (MoH 2001), which provides suggestions as to how WSPs can be developed from the Guides.

The Ministry has developed a *Small Drinking-water Supplies: Public Health Risk Management Kit* (MoH 2008), which is discussed in Chapter 19: management of small supplies.

WHO (2014) is a field guide that contains short explanations of the water safety planning process (including practical templates and tips) that support WSP development and implementation in small communities. They stress that a WSP covers all steps of the water supply system from the area where the source water originates all the way through to the point of water consumption. The whole system should be described as the basis for the WSP tasks which they itemise, along with tips and templates.

WHO (2015) supports the development and implementation of customised WSP auditing schemes by setting out the most important considerations and requirements, including:

- audit objectives
- audit methodology
- audit scope and depth of investigation
- audit timing and frequency
- auditor qualifications
- auditor training and certification
- establishing audit criteria
- evaluating and reporting audit findings.

The Guide includes a New Zealand case study.

More recent WHO publications on water safety plans include (see [http://www.who.int/water\\_sanitation\\_health/publications/water-safety-in-distribution-system/en/](http://www.who.int/water_sanitation_health/publications/water-safety-in-distribution-system/en/)):

- *Climate-resilient Water Safety Plans: Managing health risks associated with climate variability and change*. 92 pp. 2017.
- *Global Status Report on Water Safety Plans: A review of proactive risk assessment and risk management practices to ensure the safety of drinking-water*. Geneva. World Health Organization. Licence: CC BY-NC-SA 3.0 IGO. 44 pp. 2017.
- *Capacity Training on Urban Water Safety Planning – Training Modules*. 720 pp. 2016.
- *Water Safety in Distribution Systems*. 160 pp. 2014.

### 2.2.2.1 The Ministry of Health's model approach to public health risk management

The key documents of the Ministry's approach are the *Public Health Risk Management Plan Guides* (the Guides). There is no requirement for water suppliers to make use of the Guides; they may use them to whatever degree they wish.

Some terms that are used in the following sub-sections and definitions may be helpful are:

- Supply element: a physical or operational component of a water supply. Supply elements act together to determine the quantity and quality of the water received by the consumer.
- Hazard: a microbiological or chemical determinand that may cause sickness.
- Event: an incident or situation that may introduce a hazard (or hazards) into the water.
- Cause: the situation, action or inaction resulting in an event.
- Preventive measure: an action taken, or process, to reduce the likelihood of an event occurring.

### 2.2.2.2 WSP guides – development

To determine which Guides had to be prepared, water supplies were considered to consist of three supply stages: source, treatment and the distribution system. Within each of these stages supply elements were identified. The elements are the physical or operational components contained in each stage. They act together to determine the quantity and quality of the water received by the consumer.

Some elements, such as the process of disinfection, can be further subdivided, eg, chlorination, ozonation, etc. These were termed sub-elements. WSP Guides have been prepared for all elements and sub-elements where they existed. The contents of the Guides are discussed in section 2.2.2.3.

The most important factor influencing the form of the Guides was the need to make them generic documents, ie, generally applicable, not designed to meet the needs of a particular supply.

A number of principles acted as the basis for the development of the Guides:

- a) The Guides focus on what might go wrong within a supply (ie, the events), not the microbiological or chemical contaminants (hazards) in the water or the preventive measures. This was done to avoid overlooking:
  - hazards that may not have been identified at the time the Guides were prepared
  - other events, not identified in the Guide, because of too narrow a focus on the preventive measures.



- b) The Guides identify preventive measures that might not be possible to act on at present in some supplies. These are included because they are considered important and need to be noted in case future developments allow them to be put in place. Examples of this are preventive measures that cannot be implemented because water suppliers lack the legislative authority to manage their own catchments. Future changes to legislation may allow these preventive measures to be implemented.
- c) The Guides have been regarded as a means of improving industry practices where this seems reasonable. As a result, some water suppliers may find that their present practices fall short of some preventive measures and corrective actions in the Guides, and they will need to review whether an improvement in the way they manage their supplies can be achieved. These situations will probably arise most frequently in relation to distribution systems.
- d) Events with various levels of risk have been included in each Guide. No attempt has been made to omit events because they were considered to be too low a risk. Each water supplier has to determine the importance of each event for their particular situation; the Guides only indicate what should be considered.
- e) The Guides only provide generalised estimates of the levels of risk associated with each supply element. To obtain a fuller assessment of the risk associated with each event, water suppliers have to analyse the risks based on the circumstances in their supplies. The Guides do, however, contain two features that give an indication of the typical importance of events for public health:
  - an estimate of the level of risk associated with each event (evaluated on what might be expected for most supplies)
  - a risk summary, in which the event considered to present the greatest risk to public health for a particular supply element is identified, along with the most important preventive measures for this event.

### 2.2.2.3 WSP guides – content

The Guides are the building blocks from which water safety plans can be prepared. They contain the following sections and information:

- 1 Introduction: The introduction outlines the topics covered by the Guide. It also sets out possible events that can be associated with the supply element, the possible public health consequences of each event, and how the particular element can influence, or be influenced by, other supply elements. This last item is important, because it provides the operator with guidance on how the risks associated with one element may be modified by another.
- 2 Risk summary: The risk summary's purpose is to summarise the key information contained within the Guide. It is included for the supplier that may have limited understanding of drinking-water quality management. Even if the full information table later in the Guide cannot be understood, the risk summary provides, in simplified form, the most important information.

- 3 Risk information table: This table contains the detailed information that can be used in managing risks associated with the supply element. The table is divided into sections, each of which deals with a particular event. The heading of each section states the event, the hazard(s) that may be introduced as a result of the event, and provides a guide to the typical level of risk associated with the event, more lately referred to as critical control points. The events contained in the tables are potential events. They are listed to alert water supplies to events that may occur; their appearance in the table does not mean that they are all relevant to a particular supply. The supplier has to decide this for his/her own supply.

There are some deviations from this. There are some instances where micro-organisms are the hazard, but they may not be pathogens of faecal origin. For example, where sediment in part of the system is stirred up (eg, Event P2.2), faecal pathogens are not the concern. The organisms introduced into the water may be opportunistic pathogens. These organisms may be part of the normal microflora of the body, but under certain conditions cause disease in compromised individuals (Geldreich 1996).

Because the actual risks presented by a particular event will depend on the situation existing in the supply; an accurate indication of the level of risk cannot be provided in a generic document. The levels of risk given provide some guidance for those who feel unable to estimate more accurately the risks for their supply. Section 2.2.2.6 offers more detail about how to estimate a qualitative level of risk for an event.

Listed within each section of the risk information tables (ie, concerned with one event) are:

- possible causes of the event
- preventive measures that can be taken to reduce the likelihood of the event arising from that particular cause
- checks that can be made to determine whether the preventive measures are working
- signs from the checks that show when preventive measures have failed and action needs to be taken
- corrective actions that need to be taken if the event occurs despite the preventive measures in place.

Preventive measures and corrective actions are distinguished by the way in which they deal with the two aspects of risk. Preventive measures are intended to reduce the likelihood of an event; corrective actions aim to reduce the consequences of the event if it occurs. In some instances, corrective actions set up preventive measures that should have been in place already.

The suggested checks are to determine when an event has occurred and a preventive measure has not worked. Trouble-shooting may be assisted in some instances by checks that are specific to certain preventive measures and the causes they are designed to control. There are other checks, however, that are not so specific. These provide limited help in identifying the cause of an event. For example, free available chlorine (FAC) measurements are checks common to all causes that may result in the FAC concentration being too low during chlorination. A low FAC result (a critical control point) therefore indicates that an

event has occurred, and that a preventive measure has failed, but does not pinpoint what caused the problem.

The supply of undisinfected water by a water supplier in Melbourne caused by a disinfection plant failure was identified as one of the significant risks, or critical control points (CCPs), in both the wholesaler's and in the retailer's WSPs. Significant operational improvements were therefore made, including continuous monitoring of key indicators of water treatment (for example chlorine, turbidity, filter head loss); continuous review of CCP performance, including treatment plant failures; operator training; internal, external and regulatory audits; and well-established programmes of water treatment plant maintenance. As a result, a significant reduction in critical limit breaches has been achieved since 1999, including fewer disinfection plant failures. As disinfection plant failure triggers a declaration of an incident, operational expenditure on the order of A\$10,000-50 000 per incident has been avoided. Typical examples of costs avoided include mobilisation of an incident management team, field work such as water mains cleaning (flushing, air scouring, swabbing), spot chlorination of water storages, use of bottled water, use of water tankers as an alternative water supply, additional water quality sampling and laboratory testing, and customer and media communications, not to mention loss of confidence by the public. From WHO (2018).

- 4 Contingency plans: Contingency plans have been prepared for events resulting in either serious microbial contamination of the water, or substantial chemical contamination that will have acute consequences. The concentrations at which chemical hazards generally occur are low enough that their consequences are long-term. The contingency plans contain information to assist in deciding when a contingency plan is needed, and the actions that should be taken.

Contingency plans are distinguished from corrective actions on the basis of the level of risk they are intended to manage. For example, the detection of low levels of a faecal indicator in the treated water requires a corrective action, but not the implementation of a contingency plan. The detection of high levels of faecal contamination, or evidence of widespread sickness that is likely to be of water-borne origin signals the need to implement a contingency plan. The need for the implementation of a contingency plan may arise from the failure of corrective actions to reduce a hazard in the water to an acceptable level.

- 5 Performance assessment: This section of the Guide lists checks that can be made to establish how well the plan is working for the particular element in question, and how frequently the checks need to be made. Many of the checks are the same as those noted in the risk information table. Guidance is also provided on what needs to be done with the results of checks, particularly with respect to their review, and the need to use this information in the updating of the plan.

The Guides may not have identified all possible events, their causes or appropriate preventive measures. It is therefore important that, when a WSP is prepared, the water supplier remains alert to the possibility that events not listed may also occur, and does not rely solely on the Guides.

#### 2.2.2.4 The preparation of WSPs

Guidance on the preparation and implementation of WSPs is provided in the Ministry of Health's publication *How to Prepare and Develop Public Health Risk Management Plans*. The publication serves a number of functions by:

- setting out which Guides are available
- explaining in general what they contain, and the terminology used
- offering direction in the use of the Guides in preparing WSPs
- offering direction for the use of the plans once they have been prepared.

A suggested approach to the development of WSPs is set out in Figure 1 of the publication. It outlines a series of steps that should be taken in preparing plans, provides some detail as to how to carry out the step, and indicates what should come out of the step for addition to the supply's WSP. The steps are summarised in Figure 2.4 and outlined below.

It is preferable that water suppliers prepare their own WSPs, because during the process, they will become more aware of each step involved in running the supply, identify the critical points, and will therefore consider the risks, monitoring, improvements and training needs associated with each step. If it is considered necessary to use consultants, the water supplier must be closely involved in the preparation of the WSP. It is recommended that the WSP makes frequent reference to all relevant operations manuals.

WRF (2016) developed an approach for identifying potential sources of contamination upstream of drinking water intakes, particularly from aboveground storage tanks. The project was designed to help drinking water utilities follow the AWWA Standard G300 (*American National Standard for Source Water Protection*) and related guidance. The work also contributes to emergency preparedness, response, and health and safety management. They developed an eleven-step method to cover the process from delineation of upstream contributing areas and zones of concern, through data mining, contaminant research, aerial image analysis, and SWP planning and implementation. The challenges and benefits of maintaining this type of database are discussed in the report.

**Figure 2.4: Suggested approach for the development of WSPs**

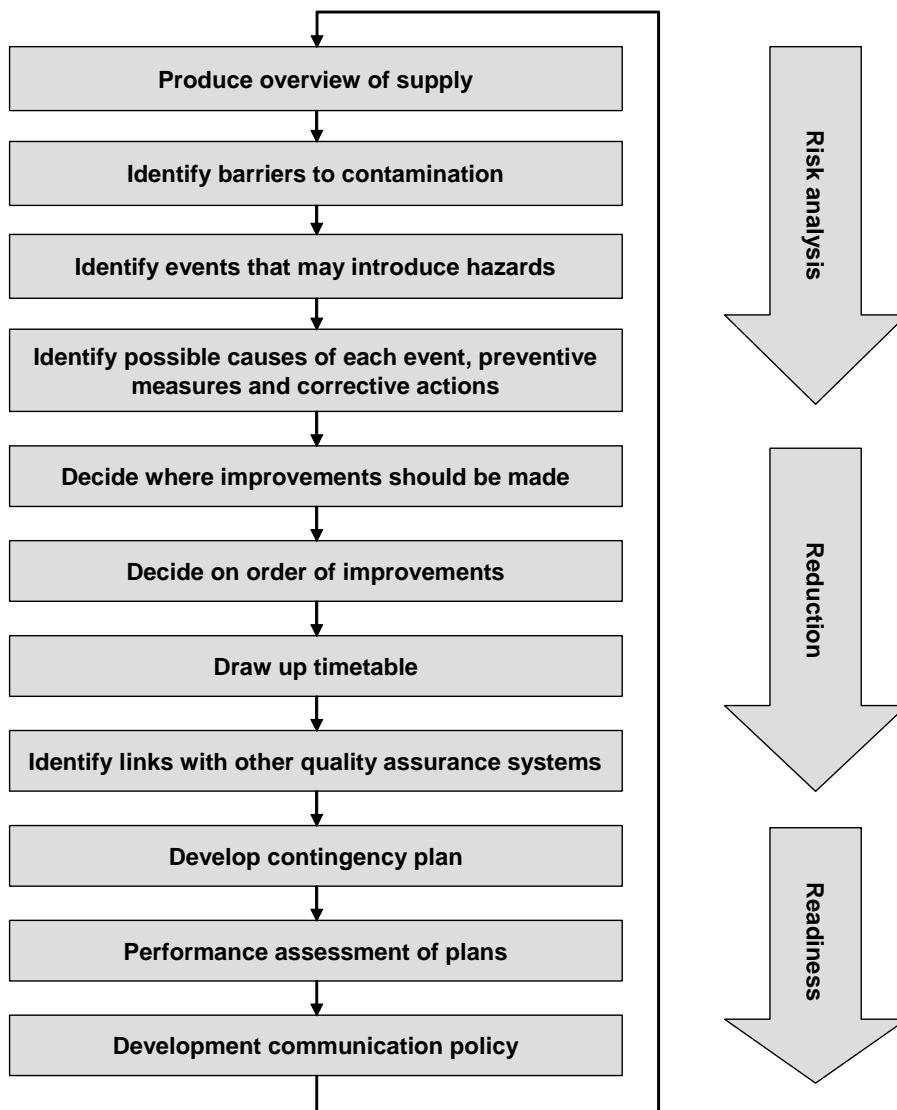

## Risk assessment

Step 1: Produce an overview of the supply and decide which WSP Guides are needed  
Contribution to the WSP: a flow diagram of the supply

The water supplier needs to identify all the elements in their supply. Without doing this all possible events that may lead to hazards being in the water cannot be identified. The step also serves to help the supplier determine which Guides will be required for preparation of the plan. The task is best accomplished by methodically working through the supply from the catchment or recharge zone, to the consumer's property and identifying all activities, processes, or physical components that may influence the quantity or quality of the water.

Although the term supply is used in the Guides, and in this section of the Guidelines, the WSP is being prepared to protect the consumers in a particular distribution zone. A neighbouring distribution zone may be subject to different events, so its WSP will need to be different.

Where more than one plant and/or more than one source provides water for a distribution zone, the flow diagram prepared in this step must include all supply elements that could influence the quality of the water reaching the distribution zone of interest.

How a water supplier is to deal with more than one supply/distribution zone in determining the priority of resource allocations is described in Step 6.

Step 2: Identify the barriers to contamination

Contribution to the WSP: checklist of barriers present

Between the source water catchment or recharge zone and the consumer's property, various elements of a water supply act as barriers to the entry of contaminants. Each barrier contributes to the safety of the supply, but it is generally recognised that the greatest protection to water quality and public health is achieved by ensuring that four fundamental barriers are in place. These four barriers must achieve the following:

- 1 prevention of contaminants entering the raw water of the supply
- 2 removal of particles from the water
- 3 inactivation of micro-organisms in the water
- 4 maintenance of the quality of the water during distribution.

Step 2 is very important in the development of the WSP because the absence of a barrier may not necessarily become evident during other steps in the preparation of the plan. A water supplier needs to know when any of these barriers is missing in their supply, because the maximum level of public health protection, especially with regard to pathogens, cannot otherwise be achieved. Supply elements that may contribute to each type of barrier are listed in Table 2.1.

**Table 2.1: Supply elements contributing to the four main barriers to bacterial contaminants**

| Barriers to ...                            | Actions or supply elements contributing to these barriers   |
|--|---|
| Stop contamination of raw waters           | Use of secure groundwaters<br>Abstraction point positioned and constructed to avoid contamination<br>Source protected from contamination<br>Actions to avoid contamination of roof catchments, and contaminants being washed from roofs |
| Remove particles from the water            | Coagulation/flocculation/clarification<br>Dissolved air filtration<br>Filtration  |
| Kill germs in the water                    | Disinfection (chlorine, chlorine dioxide, ozone, UV light)  |
| Preventing recontamination after treatment | Measures to stop contamination of storage tanks<br>Maintenance of a disinfecting residual<br>Actions taken to avoid contamination during distribution<br>Installation of backflow preventers where necessary                            |

Step 3: Use the Guides to identify events that may introduce hazards into the water  
Contribution to the WSP: Feeds into the supply's risk information table

This is the first of two steps that are the basis for producing the supply's customised risk information table. The Guides have been prepared with the aim of identifying all possible events associated with a particular supply element. It is possible that some events have been omitted, or that events that are irrelevant to a particular supply have been included. For these reasons, a water supplier needs to work through the events listed in the Guide, select those that are relevant for their customised risk information table, and add other events of concern that have not been considered.

## Risk management

Step 4: Use the Guides to identify:

- causes
- preventive measures
- corrective actions

Contribution to the WSP: Feeds into the supply's risk information table

This is the second step contributing to the preparation of the customised risk information table. Having identified the events relevant to their supply, the water supplier now needs to go through the same process of identifying the causes, preventive measures, checks on preventive measures and corrective actions that are relevant. The preventive measures, checks and corrective actions that appear in their risk information table ought to include all that should be in place, not simply those that are actually in place.

Section 2.2.2.2 noted that some preventive measures have been included that it might not be possible to act on at present in some supplies. Preventive measures of this type should be included in the supply's risk management plan with a flag that the measure cannot be implemented, and a note made of the reason. The supply's assessor will verify this during the assessment of the plan. The inclusion of these measures will serve as a reminder of the actions that need to be taken when their implementation becomes practicable.

Step 5: Decide where improvements should be made in the supply to better protect public health

Contribution to the WSP: Feeds into the supply's improvement schedule

This is the first of three steps that are the basis for preparing the improvement schedule. The purpose of this schedule is to list any of the four main barriers, preventive measures, checks or corrective actions that are missing from a supply.

From Step 2 it will be possible to identify which, if any, of the four barriers are missing from the supply. A secure bore water has met the first three barriers with respect to microbiological contamination. In the absence of dissolved chemicals of public health significance, prevention of contaminants entering the water after it is abstracted from the ground is then the only concern.

The preventive measures, checks and corrective actions that should be in place will be contained in the risk information table as the result of Step 4. These now need to be compared with what is actually in place in the supply. Identifying which preventive measures and checks are not in place, but need to be, should be straightforward. The situation is different for corrective actions however. These are actions that will not need to be taken until something goes wrong with the preventive measures. Consequently, the main concern with the corrective actions is to make sure that they are listed in the customised risk information table. In the event of something going wrong, the person responsible for the supply can then refer to the table for guidance on the appropriate action.

Step 6: Decide on the order in which improvements need to be made  
Contribution to the WSP: Feeds into the supply's improvement schedule

In this step priorities must be assigned to the improvements identified in Step 5. The most important factors to be taken into account when making these decisions are: public health, availability of resources, and the ease with which the improvement can be made.

The suggested approach is first to produce a table that ranks the preventive measures that need to be put in place in the order of the level of public health risk of the event they are intended to stop. Preventive measures associated with high-risk events should be given high priority for attention.

The Guides provide some help in obtaining estimates of public health risk:

- the risk summary in each guide indicates which events are considered to present the highest public health risk for the particular supply element, as well as the preventive measures considered most important in controlling these events
- the risk information table provides estimates of the level of risk for each event. The limitations of these typical values were discussed in section 2.2.2.2.

Where water suppliers wish to obtain an estimate of risk that is more tailored to their supply, Appendix 2 of the Ministry's guide to the preparation of PHRMPs (MoH 2001) describes how the level of risk can be estimated from its two contributing factors of consequence and likelihood. This is described more fully in section 2.2.2.6.

Once an order of importance based on public health has been determined, the water supplier needs to consider how resources (financial and otherwise) and the ease of carrying out improvements may modify this ranking. High priority should be given to improvements that can be easily made at little cost. The improvement schedule from the WSP should contribute to the preparation of the supplier's asset management plan.

The WSP should contain information giving the reasons for the final order assigned to the improvements; the assessor will seek this. The documentation should include:

- any information used to assess the likelihood of an event, if the supplier carried out their own risk estimation
- the basis for deciding on the priority of improvements when the qualitative estimated risk levels were the same
- information on costs of improvements



- links to the supply's asset management plan
- a note on the ease of implementation where this influenced the ranking
- any other factors, eg, political, that have been important in making the ranking decision.

The detail provided should be proportional to the size of the supply in question: small supplies require a minimal amount of detail, and large supplies considerably more.

Water suppliers with more than one supply face a more complex situation. When evaluating the importance to public health of improvements required in a single supply, the population is a common factor and does not have to be considered. When a supplier has responsibility for more than one supply/distribution zone, however, account needs to be taken of the population when comparing risk to public health of events in different supplies. The population of a supply determines the number of people who may get sick, and may also influence political considerations.

A possible approach to determining the order in which improvements should be made, or resources allocated, to a number of supplies is as follows:

- 1 Prepare a WSP for each supply/distribution zone. The improvements schedule should not take account of resources, as account is taken of these later in the process. An overall schedule for improvements for all the supplies/distribution zones will also have to be prepared as part of the following process.
- 2 On the basis of the information in each plan estimate the overall level of public health risk for each supply individually.
- 3 Using the level of public health risk for each supply found from the previous step (point 2) and taking account of the population, rank the supplies/distribution zones in order of their public health risk. Supplies with large populations and a high public health risk will be at the top of this list, and small supplies with a low public health risk at the bottom. Judgement will be required when determining the relative rankings where the situations are not so extreme, eg, small supplies with high public health risk, and large supplies with relatively low public health risk.
- 4 Having identified the supply with the greatest need for improvement from point 3, allocate funding to the highest priority improvement needed for this supply from its improvements schedule.
- 5 Return to point 2 and re-evaluate the overall level of public health risk assuming that the improvement in point 4 has been made and is working properly, ie, the likelihood of a particular event has been reduced. This process should be repeated until available resources are exhausted, or there are no more improvements to be made. By the end of the process, a list to provide the basis for an improvements schedule for all supplies/ distribution zones will have been produced.

Step 7: Draw up a timetable for making the improvements  
Contribution to the WSP: Feeds into the supply's improvement schedule

The final step in developing the improvement schedule is to assign a completion date and responsibility to each improvement.

Step 8: Identify links to other quality assurance systems

Contribution to the WSP: Note of other quality assurance systems in place

A WSP is one of a number of quality assurance systems a water supplier may have in place. Other systems may include monitoring and maintenance programmes and ISO 9000/14000 series systems. Maintenance schedules and monitoring programmes are suggested in many of the Guides. These, and other relevant programmes not mentioned in the Guides, should be referenced in the plan once they are implemented.

A properly developed ISO quality assurance system should aim to achieve the same goal as the WSPs, namely the protection of public health. Water suppliers with ISO systems in place should check to ensure that the ISO system provides a degree of detail for managing public health risk similar to that expected in the WSPs. If it does not, a WSP needs to be developed and linked into the ISO system to cover those aspects of management not properly dealt with by it.

A supply's WSP aims to identify possible sources of hazards that may enter the supply and the likely effectiveness of barriers to these hazards. This type of information cannot provide a supplier with information about the actual hazards present, nor their concentrations. To improve the assessment of actual risk to public health, monitoring, additional to that already undertaken for compliance or process control, is of value. This additional monitoring will identify which hazards are affecting water quality, their concentration and how variable their concentrations are. The information will help in deciding on appropriate preventive measures. Monitoring being undertaken for this purpose should also be referenced in the plan.

Step 9: Prepare contingency plans

Contribution to the WSP: Contingency plans for each supply element

Suggested contingency plans are provided in each Guide for the supply element discussed. The purpose of having contingency plans is to ensure that there is available a set of steps, thought out in advance, for reacting rapidly to situations that may pose a major threat to the health of a community through their water supply. A supply's WSP, and its contingency plans in particular, therefore need to be readily accessible to those who are likely to have to make supply management decisions in such an emergency.

Suppliers should determine which of the contingency plans in the Guides are relevant to their supply, and include additional ones if a potential situation of high risk is not covered by the existing contingency plans. The contingency plans in the Guides provide a template for the preparation of any new plans needed.

Contingency plans have been prepared to cover situations in which normal corrective actions have failed to stop hazards entering the distribution zone. They are intended to deal with circumstances in which high levels of pathogens have entered the distribution zone, or when there is acute risk from chemical contaminants. Acute chemical risks may arise from such incidents as chemical spills, volcanic eruptions, or flooding, which may deposit high concentrations of chemical contaminants into a source water.

Drought is normally associated with water shortage, but it can also impact on water quality. Cyanobacteria may become more abundant (eg, as occurred in Kaitaia in the 2009/10 summer), domestic sewage can become stronger with a possible reduction in effluent quality followed by reduced dilution in the receiving water. Ash and subsequent runoff after forest fires overseas have closed water treatment plants. Prolonged drought can cause groundwater levels to fall, increasing the risk of saline intrusion; CDC (2010). DWI (2012) discusses health impacts related to extreme event water shortages. UK Government policy is for emergency plans to go beyond the routine operational events and prepare for events which may cut off water to a large number of consumers for over 72 hours and may involve more than one water supply or company. It also needs to be taken into account how the extreme event will affect logistics of distribution of alternate supplies, the health of the population without a water supply, power, sanitation and how these periods will differ from routine operational events. Extreme events affect health beyond drinking water and this is to be taken into account when planning the response and recovery.

Step 10: Prepare instructions for performance assessment of the plan

Contribution to the WSP: Set of instructions for review of the performance of the WSP

This step in the preparation of a supply's WSP sets down a procedure for the review, and where necessary, updating of the plan. The need to update a plan may arise because of:

- a change in the circumstances of a water supply
- the identification of possible new events and their causes
- the discovery that one or more preventive measures or corrective actions are unsatisfactory
- a contingency plan has failed when implemented.

Any one of these reasons leads to the need to modify the plan to minimise its weaknesses.

The WSP performance assessment section of the Guides can be used as the basis for preparing instructions for reviewing the operation of the overall WSP for the supply. In addition to the components of the review noted in the Guides, the review instructions should include the need to:

- note the frequency at which the plan should be reviewed
- record any events that have occurred since the last review, and the actions taken as a result of the event. These actions may include improvements to preventive measures, the introduction of additional preventive measures, corrective actions, and new monitoring or maintenance programmes
- record changes, additions or deletions that have been made to supply elements
- re-evaluate the improvement schedule. Changes occurring between reviews may require a revision of the relative importance of the improvements needed, and consequently a reordering of the schedule.

Step 11: Decide on communication policy and needs  
Contribution to the WSP: Set of instructions for reporting

The communication section of the plan should identify and record the people to whom reports concerning the management of risk to the supply should be made, what information these reports should contain and how often they should be made.

The people who need to receive reports will depend on the management/ownership structure of the supply. For example, a school may be required to report to its board of trustees and a municipal water supply manager to his or her managers, the local authority councillors, and the ratepayers.

The nature of the material reported, and the language used, need to be appropriate for the recipient(s) of the report. Thought should also be given to the way in which recipients may perceive risk and how this may need to influence the wording of the report. Perceptions of risk can vary widely depending on such things as the assumptions, concepts and needs of the stakeholders.

### 2.2.2.5 The implementation of water safety plans

Figure 2 in the Ministry of Health's *How to Prepare and Develop PHRMPs* publication describes what should be done with the WSP once it has been prepared. This diagram is summarised in Figure 2.5.

**Figure 2.5: Process for the implementation of WSPs**

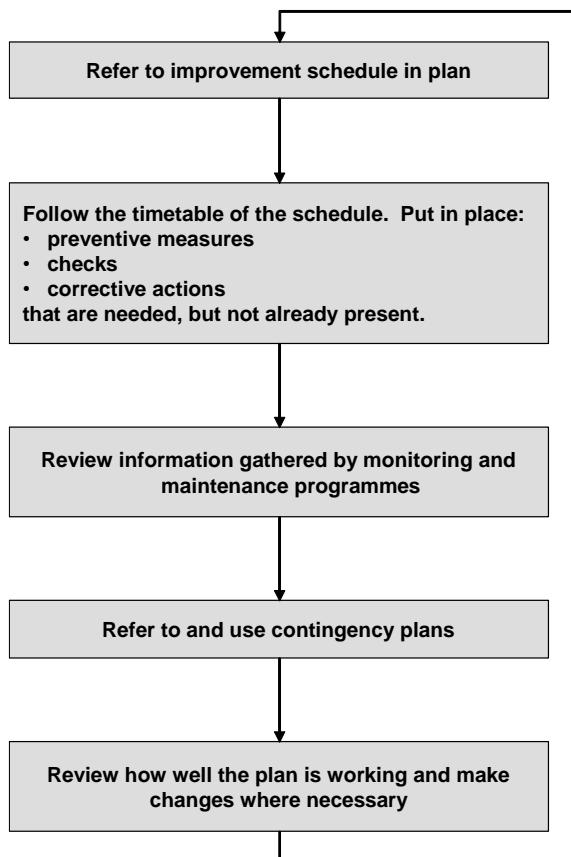

Step 1: Refer to the improvement schedule.

Step 2: Follow the timetable in the schedule for making improvements.

By following the improvement schedule the water supplier should be able to:

- determine which capital works need to be undertaken and when
- determine whether any new plant is scheduled for installation and when
- put in place monitoring programmes. These should state:
  - what is being monitored
  - when samples are to be taken
  - where samples are to be taken
  - who will take the samples
  - which laboratory is to be used, or whether the measurement will be carried out by works or field staff
  - what is to happen to the results
- put in place maintenance programmes. These should state:
  - what is to be checked and maintained
  - how often checks are to be made
  - who is to make the checks
  - what is to happen to the check results
- put in place staff training programmes. These should state:
  - the purpose of the training
  - which staff are to be trained
  - how often refresher courses are needed.

Step 3: Review information gathered by monitoring and maintenance programmes.

The WSP should record how frequently information from monitoring and maintenance programmes should be reviewed, by whom, and to whom they should report in the event of something of concern being spotted.

Reviews of this nature are important in helping staff become familiar with levels of determinands, or conditions, that are normal and satisfactory, and those that are not. These reviews and alertness to changes, or the occasional result of concern, may provide signs of possible future problems. Identification of problems at an early stage may allow remedial actions to be taken before a significant threat to public health develops.

All supply staff have a responsibility for ensuring that good quality water reaches the consumer. Irrespective of the job a staff member has, if they become aware of a problem this information must be passed to their manager as soon as possible.

Step 4: Refer to and use the contingency plans if necessary.

Unlike the other steps in this sequence, contingency plans will not be used on a regular basis. When a contingency plan has to be used, the actions that need to be taken depend on such things as the type of hazard that is in the water, its likely concentration, and how far it has travelled into the distribution system. Consultation with the Medical Officer of Health may be necessary in assessing the seriousness of the event and what actions need to be taken.

As with other aspects of the WSP, it is important to discover why it became necessary to use the contingency plan, and any shortcomings of the contingency plan itself. Both sets of information can be used to modify and improve the plan.

Step 5: Review the operation and performance of the Plan.

This is discussed in step 10 in section 2.2.2.4.

Step 6: Return to step 1.

The series of steps outlined above need to follow a regular basis. This ensures that:

- the need for improvements to the supply are addressed regularly
- the Improvement Schedule is updated to take account of improvements
- the plan is modified and improved as experience shows where there are weaknesses.

As time goes on, the degree of modification required should diminish as the system becomes more refined, although major changes to the supply may require the re-identification of events, causes, preventive measures etc.

For the plan to be of value it must be used, and this is more likely to happen if it is kept current and can be used by the water supply manager as a guide to the use of resources.

### 2.2.2.6 Risk analysis

Risk analysis is performed to separate minor risks from major risks, and to provide information that will help in the evaluation and treatment of risks. Identification of the level of risk associated with a particular event assists in establishing the priority that should be given to putting in place preventive measures to reduce the likelihood of the event occurring.

Risk analysis can be undertaken at various levels of refinement: qualitative, semi-quantitative, quantitative, or a combination of these depending on the circumstances. Which is used will depend on the information available. Unless the information on which the analysis is based is very reliable, a set of numbers produced by quantitative calculations may give a false sense of reliability to the analysis. Should quantitative analysis be undertaken, it is advisable to carry out a sensitivity analysis to determine how the results vary as the individual assumptions made in the calculation are varied. This will show the reliability of the calculated risks.

Risk is measured in terms of consequences and likelihood (AS/NZS 2004). Thus, the level of risk of an event that has a high probability of occurring and which may lead to severe illness and death is very high. An event that may occur very intermittently, and with very little effect on public health has a low level of risk associated with it.

To evaluate the level of risk associated with an event, an estimate of how frequently such an event is likely to occur, and an appreciation of the effects on public health of the event, if it were to occur, is needed. Where sufficient data are available it may be possible to calculate the probability of the event occurring and the severity of its consequences. Situations where there are sufficient data to carry out such calculations for drinking-water supplies are rare. The water supplier therefore needs to rely on qualitative estimates of likelihood and consequence.

Assistance in evaluating consequence can be gained from understanding the factors that contribute to it. These include the:

- number of people that are exposed to the hazard(s); the greater the number of people exposed, the more severe the consequences
- nature of the hazard and its likely effect on health, which requires consideration of its concentration in the water, eg, the effects of elevated levels of algal toxins in the water, are much more severe than the presence of an organism that may lead to mild diarrhoea
- duration of exposure to the hazard(s); longer exposures may increase the severity of the health effects and increase the number of people suffering these effects.

For most events the water supplier is unlikely to have values for most of these factors. Apart from the population, a broad classification of the hazard, ie, whether it is to be microbiological or chemical may be the only guide to the severity of the consequences. The likelihood factor may therefore best assist the water supplier in estimating the level of risk for the event. Sources of information that can be of value in doing this are:

- past records
- the water supplier's own experience
- the experience and practice of the water supply industry as a whole
- published research
- the opinions of specialists and other experts.

The best guidance water suppliers have for estimating the likelihood of an event is from their own records and staff experience. The international literature may occasionally make comments about the frequency at which certain events occur. These do provide some guidance, but they may be an average value, or derived from a single supply, neither of which will necessarily provide a reasonable estimate of the frequency for the supply in question.

Appendix E of AS/NZS 4360:2004 contains an example of how qualitative levels of risk can be derived from qualitative estimates of consequence and likelihood. The tables for consequence and likelihood used in this example can be modified to provide descriptions that are more suited to water supplies. The following are suggested alternatives. For a given water supply, where the population is fixed, the descriptors for

consequence may be better linked to the percentage of the population affected and the nature of the effect, eg, mild gastrointestinal upset, severe diarrhoea, etc.

### Likelihood scale

| Likelihood ranking | Description                                 |
|--------------------|---|
| Rare               | May occur only in exceptional circumstances |
| Unlikely           | Could occur                                 |
| Possible           | Might occur at some time                    |
| Likely             | Will probably occur                         |
| Almost certain     | Is expected to occur in most circumstances  |

### Consequence scale

| Consequence ranking | Description                       |
|---------------------|-----------------------------------|
| Insignificant       | Insignificant                     |
| Minor               | Minor impact for small population |
| Moderate            | Minor impact for big population   |
| Major               | Major impact for small population |
| Catastrophic        | Major impact for big population   |

This gives the following estimates of risk, ISO 31000 (2009):

| Likelihood     | Consequences  |        |          |           |              |
|----------------|---------------|--------|----------|-----------|--------------|
|                | Insignificant | Minor  | Moderate | Major     | Catastrophic |
| Almost certain | Medium        | High   | High     | Very high | Very high    |
| Likely         | Medium        | Medium | High     | High      | Very high    |
| Possible       | Low           | Medium | Medium   | High      | High         |
| Unlikely       | Low           | Low    | Medium   | Medium    | High         |
| Rare           | Low           | Low    | Low      | Medium    | Medium       |

Scales of likelihood and consequence, and a risk matrix, which are more related to use in water supply than these more general tables are given in Tables 4.1 and 4.2 of the *WHO Guidelines for Drinking-water Quality* (WHO 2017).

## 2.2.3 Contingency planning

Water supply authorities should identify and assess any local conditions that may threaten the integrity of their system (refer section 2.2.2.2). It is essential that water suppliers develop contingency plans to be invoked in the eventuality that an emergency arises. These plans should consider:



- potential natural disasters (such as earthquakes,<sup>2</sup> volcanic eruptions, algal blooms, droughts and floods)
- accidents (spills in the catchment or recharge area)
- areas with potential backflow problems (including ones with fluctuating or low pressures)
- damage to the electrical supply
- damage to intakes, treatment plant and distribution systems
- human actions (strikes, vandalism, and sabotage).

Contingency planning should establish a series of steps and procedures for dealing with emergencies. The plans should specify responsibilities clearly in the water supply authority and with outside authorities for co-ordinating the response. This should include a communications plan to alert and inform users of the supply, plans for providing and distributing emergency supplies of water, and liaison with the Medical Officer of Health or other designated officer of the Ministry of Health. These plans should be developed in liaison with civil defence personnel. Contact with civil defence should be maintained and the plans updated.

The contingency plans should also cover:

- assignation of responsibilities
- priorities for dealing with multiple problems
- investigation of all probable causes of the emergency
- an assessment of the public health risk arising from the emergency
- an epidemiological investigation if deemed appropriate by the Medical Officer of Health (if a causal relationship between the water supply and illness is suspected but not obvious)
- action required to mitigate any public health risks which may have been revealed by the emergency (this may include initiating legal proceedings if negligence can be proved)
- advising and liaising with the Medical Officer of Health.

Occasional emergency exercises will help the public develop confidence in their water supply at the same time as the water supplier and cooperating parties learn how to cope.

Chapter 7 of WHO (2003) addresses emergency planning and response issues in water supplies. WHO (2011a) provides a range of technical notes covering emergencies.

<sup>2</sup> 37 papers were presented at the 10th JWWA/WRF/CTWWA Water System Seismic Conference in October 2017 in Taiwan. Available at <http://www.waterrf.org/PublicReportLibrary/WSSC10Proceedings.pdf>

## 2.2.4 Response to incidents

One of the key measures for success for a risk management system is how well an organisation responds to a risk event. Even with the best risk management system in place things will go wrong and organisations need to respond. In fact responding to a number of small events can be positive as it can help organisations identify areas that need to be improved in order to prevent larger, more serious events from occurring. Risk events have a number of characteristics including:

- they can get worse
- they can have wide ranging impacts
- their effects can be ongoing.

For example, heavy rain may initially cause flooding and resources could be focused on protecting habitable floors and maintaining road networks. However, if the heavy rain and flooding starts to contaminate the water being received at the treatment plant there may be a risk to public health from drinking water and boiled water notices may need to be issued. The incident is now far worse than initially thought, the communication needs are a lot greater, the impacts may now affect a whole community, it may take days to rectify the situation and the ongoing investigations as to why the event occurred may take several months.

Organisations therefore need systems, communication and responsibility networks and trained staff to be able to recognise and respond to the changing circumstances that occur in an event and implement the contingency plans that should have already been developed. Risk communication is discussed thoughtfully in Chapter 14 of WHO (2001). Water UK (2010a) has prepared a Technical Guidance Note to help water suppliers prepare. Risk communication is any purposeful exchange of information about risks between interested parties. More specifically, risk communication is the act of conveying or transmitting information between parties about a range of areas including:

- levels of health or environmental risks
- the significance or meaning of health or environmental risks
- decisions, actions or policies aimed at managing or controlling health or environmental risks.

Interested parties include government agencies, corporations and industry groups, unions, the media, scientists, professional organisations, interested groups, and individual citizens.

### 2.2.4.1 Incident levels

As risk events can very quickly escalate, become far more complicated and their effects felt more widespread, organisations often develop a system of incident levels. At the lowest level, eg, minor flooding, the situation may be handled by normal work crews, but with management and call centres informed to the extent of flooding. As the situation worsens a higher level may be triggered with more senior staff and specialist staff called in to undertake tasks such as investigating the water catchment. An even higher level may be triggered if it is likely that the water supply may be contaminated

and outside agencies such as Ministry of Health and Civil Defence informed. On a larger scale, the USEPA has begun to address issues related to terrorism (USEPA 2004).

### 2.2.4.2 Organisation

Initially when an event occurs, the focus is often on putting the immediate situation right. However, as the event develops and escalates there needs to be increased focus on planning, communication and logistics. People need to be thinking about what is going to happen in one hour, four hours, the next day and the next week, and they need to start to put in place plans for dealing with these situations. Key people need to be communicating with the public, press and health authorities. Yet others will need to be addressing logistical issues such as organising emergency staff for the next shift, and the materials and equipment required to rectify the situation. If these areas are not addressed then the immediate situation may be fixed but the risk to public health may remain. For example in the situation discussed at the beginning of this section, if the contaminated supply to the treatment plant is isolated, but boiled water notices are not communicated to the whole community, then the public will be unaware of the potential risks and may continue to drink contaminated water.

Some organisations are therefore using the Coordinated Incident Management Response System (CIMS) as shown in Figure 2.6 to structure their teams that respond to incidents. Under the CIMS structure an Incident Controller is assigned who has overall responsibility for managing the incident. Reporting to the Incident Controller are personnel who are responsible for operations, planning, communications and logistics. Advantages of CIMS are:

- it provides clearly defined roles and responsibilities
- it compartmentalises thinking, so personnel only have to think about their particular tasks rather than trying to tackle the whole incident and miss critical issues in the process
- it provides common management structure and terminology with emergency organisations such as the Fire Service and Civil Defence.

**Figure 2.6: Organisation of incident management teams**

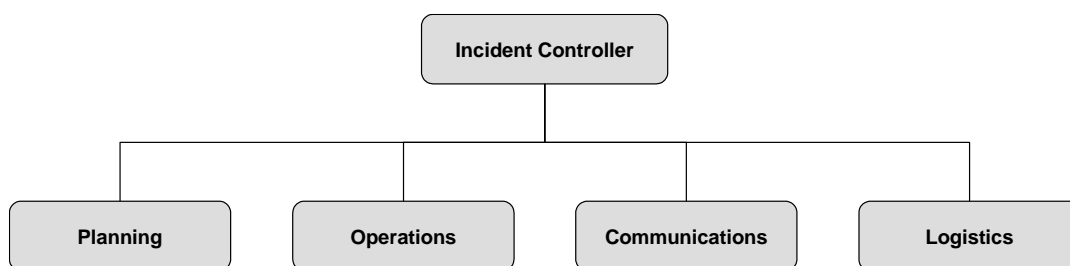

## 2.2.5 Debriefings

Debriefings should be conducted after all incidents and exercises. Their purpose is to use the experiences and lessons learned during the incident or exercise to make improvements, so that further incidents can either be prevented from recurring or managed more effectively. Debriefings should not be seen as a blame laying exercise; rather they should be seen as a positive step for improving the organisation's risk management.

Debriefings should involve all participants in the incident or exercise including contractors, service providers, affected parties and regulatory agencies.

The debriefing process involves:

- description of the events: involves describing the incident in detail, listing the names of the people involved, the sequence of events, the impacts of the incident and any relevant information. At this stage it is important that only the facts are recorded and assumptions are not made
- corrective action: the immediate actions taken to fix the problem are described and the people and organisations informed of the incident are noted
- immediate post incident debriefing: the views of the participants immediately after the incident are recorded. This information may be subjective and may be just one person's view, but it gives a basis for further investigation during the structured debriefing
- structured debriefing: a root cause analysis is conducted. This involves looking at each event and asking why it happened? The question continues to be asked until the team has drilled down to the root causes of the incident. The analysis considers:
  - the physical causes of the incident
  - resources, eg, equipment
  - available information, both before and during the incident
  - human resources, eg, availability of resources and training
  - communication, both before and during the incident
  - planning and procedures, both to avoid the incident and to respond to the incident
  - processes, eg, were the plans and procedures that are in place followed
  - leadership
- preventive actions: following the debriefing, the actions required to prevent a recurrence or to improve the effectiveness of the responses are identified. Staff are allocated responsibility for actioning these items and a timeline is set.

## 2.2.6 Sanitary surveys

The expression 'sanitary survey' is used internationally to cover a wide range of activities. The following terminology has been used in the DWSNZ:

- a) catchment assessment: assessing what may affect the raw water quality
- b) sanitary inspection: inspecting the whole drinking-water supply
- c) bore head protection: inspecting bore heads to ensure they provide adequate sanitary protection
- d) protozoal risk categorisation: considering the catchment in terms of its protozoal risk (Appendix 3 in the DWSNZ).

Sanitary surveys of the catchment, abstraction point, treatment plant, and distribution system should be undertaken by the water supply authority as part of any programme of risk management. They should be conducted with sufficient frequency to be useful in interpreting trends or sudden or significant changes in water quality as revealed by routine monitoring.

The surveys identify potential risks, whilst monitoring can record process performance and water quality trends, whether contamination is occurring, and the extent and the intensity of that contamination.

The USEPA defines a sanitary survey (*Title 40 CFR 141.2*) as an onsite review of the water source, facilities, equipment, operation, and maintenance of a public water system for the purpose of evaluating its ability to produce and distribute safe drinking-water. The sanitary survey should be conducted by qualified persons and identify contamination or deficiencies and inadequacies in the catchment, treatment plant or distribution system, which could result in failure to control contamination should it occur. The USEPA (1999) prepared a sanitary survey guidance manual, which contains a lot of valuable information.

A sanitary survey is indispensable for the proper interpretation of analytical results. No microbiological or chemical survey, however carefully it is made, is a substitute for a thorough knowledge of the conditions at the source and points of abstraction, the treatment process and the distribution system. Sample results represent single points in time; the sanitary survey provides information to determine whether the analytical results are likely to be typical. Contamination may be random and intermittent, and if so, it is rarely revealed by occasional sampling. However, a sanitary survey may identify a potential source of contamination that may then be investigated by targeted monitoring.

A catchment assessment should review such items as land use, whether road or rail systems pass through the catchment, disposal of human and animal wastes, storage and use of chemical contaminants such as pesticides, the presence of existing sanitary landfills and old dumps, release of nutrients, erosion status, levels and disease carrier status of animals (feral, agricultural, and domestic), protection of intake structures from human and animal access, sealing of well casings, protection of wells from flooding, and human access restrictions and security. These factors should be assessed in relation to climatic and hydrological conditions.

The frequency with which catchment sanitary surveys should be performed will be a function of factors such as access control, existing risks, size of population served, accessibility of catchment and seasonal conditions, so cannot be rigidly specified. As a general rule, a thorough survey should be performed every five years, with several less detailed inspections occurring within that period, or when any change in land use or water quality is suspected.

## 2.2.7 Staff and contractors

The successful management of water supply systems depends on having staff and contractors that have the necessary knowledge and ability to manage and operate the system, identify potential risks and propose improvements.

The procedure for developing a programme to ensure that all staff have the necessary skills and training will typically involve:

- 1 preparing job descriptions: each employee should have a detailed job description that sets out their duties, key result areas and performance criteria
- 2 training needs analysis: meetings are normally held with individual staff members to identify gaps between the duties that the staff are required to undertake and their skill level. Training needs are identified and prioritised
- 3 training programme development: from the training needs analysis the most suitable type of training is determined. Training needs may be a mix of:
  - on-job training
  - off-site training
  - informal meetings and conferences
  - encouragement to belong to professional and technical organisations
  - internal advocacy of the knowledge industry through actions such as internal distribution of technical journals, encouragement to attend local interest meeting
  - recognition of current competencies
- 4 development and budgeting for a training programme for water staff
- 5 auditing of the training programme – to assess whether the programme has been initiated and prove that the required levels of competency have been achieved.

The MoH has prepared a PHRMP Guide on Staff Training, Ref G1.

It is recommended that water suppliers undertake a similar process when engaging contractors. This would involve:

- 1 preparing task descriptions
- 2 identifying minimum required levels of training and experience
- 3 detailing required training and experience levels in the contract documents
- 4 auditing to ensure that the contractor's staff have the required levels of competency.

Water Industry Training has developed a number of national qualifications in partnership with the water industry. The qualifications have been designed to include practical training and assessment at the workplace, complemented with theory-based training through accredited training providers. The qualifications currently available include:

- 1 *National Certificate in Water Treatment – Site Operator*: includes drinking-water treatment theory, and practical operation of a range of conventional treatment systems. The qualification requires approximately two years of part-time study and on-job learning
- 2 *National Diploma in Water Treatment – Site Technician*: includes quality assurance, safety, managing and optimising advanced water treatment processes on site. The qualification requires approximately two years of part-time study and on-job learning
- 3 *National Certificate in Water Reticulation*: includes trenching technology, safety, reticulation systems and disinfection. The qualification requires approximately one year of part-time study and on-job learning
- 4 *National Diploma in Drinking Water-Assessment*: includes treatment technology, assessing and implementation of WSPs and communications skills. The qualification requires approximately two years of part-time study and on-job learning.

It is also important for water suppliers to have in place a good sanitation and housekeeping programme to ensure that the actions of staff and contractors do not contaminate the water supply. Items typically covered in such a programme would involve:

- all employees and personnel in the plant must wear clean outer clothing
- employees working in the water processing areas must wash and sanitise their hands before returning to the work area and any time when the hands may have become soiled or contaminated
- eating, drinking, smoking, or engaging in any other activity around the water processing areas which may introduce contamination of any kind is prohibited
- an effective hair restraint is required of all employees or personnel in the water processing areas
- no person affected by disease in a communicable form, or while a carrier of such disease, or while affected with boils, sores, or infected wounds, shall work in a water plant in any capacity in which there is any remote possibility of the water supply becoming contaminated by that person, or of a disease being transmitted by such person to other individuals working within the water plant
- only authorised employees and personnel are allowed in the water processing areas
- signs should be posted outlining the above requirements.

## 2.3 Quality assurance

### 2.3.1 Key features of quality assurance

The overriding principle of quality assurance is that if the process used to deliver the end product and the factors that impact upon that process are well understood then it is possible to implement measures to control the process so that a product of consistently high quality is achieved.

Whereas risk management focuses more on the actual processes used to deliver the quality end product, quality assurance focuses more on understanding and managing the factors that impact on the processes. In the context of a water supply system, risk management focuses on the processes of collecting, treating and then distributing water and the interrelationships between these processes. But, as well as understanding the risks of the processes, it is equally important to understand other factors that control and support the provision of safe drinking-water – regulatory, organisational structure and processes, human and financial resources.

Examples include:

- the Ministry of Health, with their requirements being set out for example in the DWSNZ
- other government agencies, with their requirements being set out in legislation and policies such as Local Government Act and Resource Management Act
- councillors, the community and water users, with their requirements outlined in documents such as by-laws, long term council community plans and supply contracts
- everyone in the organisation is involved and takes responsibility for ensuring that the part of the process for which they are involved is functioning effectively. Responsibility, decision-making and ownership are delegated as far down the chain of command as possible
- there are enough personnel and they have adequate experience and training to undertake their tasks
- there is enough equipment and it is maintained so that it remains accurate and reliable
- standard procedures are in place to provide direction and allocate responsibilities to staff when they are undertaking critical tasks
- monitoring ensures that the systems are working well and provide early warning of possible problems
- surveillance is directed to ensuring that the whole process is right, not merely in checking the quality of the product at the end of the process.



## 2.3.2 Application to drinking-water supplies

The Public Health Grading of drinking-water sources, treatment plants and distribution systems includes a requirement to have an approved quality management system if the highest grading (A1 for treatment, a1 for the distribution system) is to be achieved, see Chapter 18, section 18.4 for a discussion on aesthetic guidelines methodology. The scope of such a management system would cover all aspects, from source to consumer.

The basic structure of a quality management system that is appropriate for a community drinking-water supply is shown in Figure 2.7.

**Figure 2.7: Basic structure for a quality management system**



ISO 9001 2000 requires organisations to document the following:

- Quality policy that outlines the organisation's commitment to meet customer, legal and regulatory requirements. The quality policy is supported by the quality objectives the organisation strives to achieve. Quality objectives must be measurable and communicated throughout the organisation. Quality objectives are often developed as part of the preparation of long-term council community plans.
- Quality manual that includes documented procedures for managing the quality system. It is mandatory that the quality manual include documented procedures for:
  - control of documents: they must be legible, identified, reviewed, authorised, distributed and periodically updated
  - control of records: they must be legible and easy to identify and retrieve
  - planning and conducting internal audits: these must be undertaken regularly for each area covered by the quality system. Audit results must be reported, recorded and follow up actions verified

- non-conforming product (ie, product that does not meet the quality objectives): when non-conformances occur they must be investigated and actions implemented to prevent recurrences
- preventive actions: the same systems that must be in place for dealing with non-conforming products are required to be in place for dealing with potential problems that have not yet resulted in defective products.

The quality manual is also required to include a description of the interaction of the processes that make up the quality system. This normally takes the form of flowcharts that may for example show the various stages of the collection process and the measures taken to control it and how it interacts with the treatment process. The Ministry of Health's guide *How to Prepare and Develop PHRMPs for Drinking-water Supplies* contains several examples of flowcharts that can be used to describe the water supply process.

- Work instructions: these cover procedures for undertaking specific tasks for which the organisation considers it is necessary to have a documented procedure in place to control the process. Work instructions normally cover:
  - the scope of the procedure, ie, what activities are covered/not covered
  - who is authorised to undertake the task, eg, their required qualifications or experience
  - the procedures that must be followed
  - processes for checking that the work has been completed correctly
  - processes for reviewing, authorising, distributing and updating the work instructions.
- Supporting documentation that includes externally sourced documentation such as manufacturers' manuals, reference standards and operating manuals.
- Records that are kept to demonstrate that the quality system is working correctly. Examples of records normally kept include:
  - training records
  - machinery calibration and maintenance records
  - records from suppliers of materials
  - results of tests and measurements undertaken
  - details of internal audits and follow up actions
  - meeting minutes
  - correspondence.

Documentation can either be paper-based or electronic. Increasingly, organisations are using databases or websites to publish and store documents, as they are easier to update and provide staff with better access than paper-based systems.

The quality assurance system should be seen as a living entity. To stay effective the system needs to be adapted to accommodate items such as changing circumstances, changing requirements, the identification of new hazards, or identification of improved ways of doing things.

Organisations are also tending to produce integrated management systems that cover risk management, asset management, health and safety, environmental and financial matters, as well as quality, all under the same system. In doing so they are recognising that when tasks are being undertaken, employees do not consider, for example, health and safety in isolation, and then quality, but they need to consider all of these aspects at the same time. By developing an integrated management system organisations can simplify the amount of documentation required and develop documentation that reflects the way that work is actually carried out.

## 2.4 Quality control

Quality control provides the checks to demonstrate that risk management and quality assurance has produced a product that complies with standards, and feedback to the adequacy of risk management. In many situations the DWSNZ have set transgression levels. A transgression may not result in a non-compliance. Using quality control principles, a water supplier will establish control limits, with the aim of triggering some action to prevent the value reaching a transgression level or operational requirement. Control limits, and the actions to be followed when reached, should be covered in WSPs. The Ministry of Health evaluates the compliance of a drinking-water supply with the DWSNZ on a regular basis and uses this in determining the Public Health Grading of community drinking-water supplies and in preparing its annual report on drinking-water quality in New Zealand.

This section discusses compliance in general terms. Chapters 6–11 discuss the DWSNZ compliance criteria and requirements in more detail. Demonstrating compliance with the DWSNZ requires more than demonstrating that the water quality is satisfactory. Other requirements, which are described in more detail in section 3.1.1 of the DWSNZ, include demonstrating:

- a) the prescribed number of samples have been taken from the correct places at the prescribed frequencies
- b) the samples have been analysed according to approved methods and by a Ministry of Health recognised laboratory
- c) compliance requirements have been met for the previous 12-month period
- d) the necessary actions have been taken in response to results
- e) up-to-date records are kept.

In addition to keeping good records, good quality control practice includes:

- a) reviewing results on a regular basis for trends or changes
- b) reporting the results to those who need to know – water supply staff, management, health officials, community
- c) reviewing and updating WSPs and associated documentation such as procedures.

A national database system for drinking-water, Water Information New Zealand (WINZ), serves a multitude of roles in ensuring water supplies are identified, their water quality assessed and their risks managed. WINZ is the primary database for managing compliance with DWSNZ and public health grading, and records supply-specific characteristics, monitoring results, and responses to transgressions.

## 2.5 Quantitative microbial risk assessment (QMRA)

WHO (2016) discusses the use of QMRA as a tool in water safety management. The following has been copied:

QMRA offers a systematic way to use scientific information to help support water safety management decisions on a utility or regulatory level and prioritise remedial actions or research efforts. The numerical output of QMRA addresses the risk management questions in finer detail and allows for more precise comparison between risk management options compared with the qualitative or semi-quantitative approaches. QMRA is a framework or mechanism that allows for quantitative scientific data to be interpreted in the context of estimated health outcomes in order to support water safety management.

For water safety management, the use of QMRA was first proposed in the early 1990s. Since then, QMRA has been used in different levels of detail for drinking-water, recreational water (outdoor and in pools), reuse of domestic wastewater or excreta in agriculture and many other forms of human water use. More detail will come with the expense of more time, more data and expertise; however, the outcome will result in more detailed understanding of the risks and control measures.

QMRA is a formal four-step risk assessment process as shown in the table, where each component of the assessment is explicitly quantified.

Summary of the four-step framework for water-related QMRA:

| Step                      | Description  |
|---------------------------|--|
| Problem formulation       | The overall context (reference pathogens, exposure pathways, hazardous events and health outcomes of interest) of the risk assessment is defined and constrained in order to successfully target the specific risk management question that must be addressed. |
| Exposure assessment       | The magnitude and frequency of exposure to each reference pathogen via the identified exposure pathway(s) and hazardous events are quantified.   |
| Health effects assessment | Dose–response relationships (linking exposure dose to probability of infection or illness) and probability of morbidity and mortality (depending on the health end-point of the assessment) are identified for each reference pathogen.                        |
| Risk characterisation     | The information on exposure and the health effects assessment are combined to generate a quantitative measure of risk.   |

An example of a (deterministic) QMRA to determine the safety of a surface water supply follows.

## QMRA to determine treatment performance targets following the WHO GDWQ *Problem formulation*

A drinking-water supply is producing drinking-water from a river, using conventional treatment (coagulation/filtration) and ultraviolet disinfection. This river flows through a number of large urban centres and agricultural lands. Looking at the WHO GDWQ, the utility would like to demonstrate that the drinking-water meets the health outcome target of  $10^{-6}$  DALY per person per year (pppy). Given the human and animal faecal sources in the catchment, the utility wants to include enteric bacteria, viruses and protozoa in the QMRA. It was decided to focus on *Campylobacter*, rotavirus and *Cryptosporidium* as reference pathogens for demonstrating the target is being met. It was also decided to translate the  $10^{-6}$  DALY into treatment performance targets, following the approach in the WHO GDWQ (Table 7.4 in the WHO GDWQ).

### Exposure assessment

The utility has no data on the selected reference pathogens *Campylobacter*, rotavirus or *Cryptosporidium* in source water or on pathogen removal by the water treatment processes. Therefore, the utility made an effort to collate data on the occurrence of these reference pathogens in water systems with similar source water (sewage-impacted rivers with limited catchment protection) from the scientific literature. As there was uncertainty about how to translate these literature data to the specific site, the 95th percentile of the literature data from these source waters was selected as input for the QMRA. Limited data on rotavirus were found, so the utility used culturable enterovirus data instead. Similarly, data on the removal of the reference pathogens by coagulation/filtration processes and by UV were taken from scientific literature (review by Hijnen and Medema 2010). For coagulation/filtration, the mean removal deduced from all literature data was used; for the UV disinfection, the local UV fluence setpoint ( $400 \text{ J/m}^2$ ) was used to translate the literature data to the local system. For the consumption of (cold) tap water, no local data were available, so 1 L per person per day was used (as assumed in Table 7.4 of the WHO GDWQ).

|                                      | Data source   | <i>Campylobacter</i> | Rotavirus <sup>a</sup> | <i>Cryptosporidium</i> |
|--------------------------------------|---|----------------------|------------------------|------------------------|
| Source water (number/L)              | 95% of data from literature on sewage-impacted rivers | 240                  | 0.5                    | 11                     |
| Coagulation/filtration (log removal) | Hijnen and Medema (2010)                              | 2.1                  | 3.0                    | 3.2                    |
| UV (log removal)                     | Hijnen and Medema (2010)                              | >5                   | 4.0                    | >3                     |

<sup>a</sup> Virus concentration in source water is based on literature data on culturable enterovirus.

### Health effects assessment

The dose–response relationships for *Campylobacter*, rotavirus and *Cryptosporidium* that are presented in the WHO GDWQ were used in this QMRA. In the absence of local data on disease burden (DALYs per case) and susceptible fraction of the population for these pathogens, these values were also taken from the WHO GDWQ.

|   | Data source    | <i>Campylobacter</i> | Rotavirus <sup>a</sup> | <i>Cryptosporidium</i> |
|---|----------------|----------------------|------------------------|------------------------|
| Dose–response (probability of infection per organism) | GDWQ Table 7.4 | 0.019                | 0.59                   | 0.2                    |
| Risk of illness given infection                       | GDWQ Table 7.4 | 0.3                  | 0.5                    | 0.7                    |
| Disease burden (DALY/case)                            | GDWQ Table 7.4 | $4.6 \times 10^{-3}$ | $1.4 \times 10^{-2}$   | $1.5 \times 10^{-3}$   |
| Susceptible population (%)                            | GDWQ Table 7.4 | 100                  | 6                      | 100                    |

## Risk characterisation

The risk management question was to evaluate whether the water supply system was capable of meeting the health outcome target of  $10^{-6}$  DALY pppy. A deterministic QMRA was conducted, based on the data collected from the literature. The main uncertainty is the validity of the use of the literature data for this specific water system. This led to the selection of the 95th percentiles of the concentrations of the reference pathogens as input values for the risk characterisation. The treatment performance target was computed from the difference between the pathogen concentration in source water and the water quality corresponding to the health outcome target of  $10^{-6}$  DALY pppy (see also above). This was compared with the estimated treatment performance (extracted from literature data; Hijnen and Medema 2010), showing that multiple barriers in the treatment were needed and together were capable of producing water that meets the  $10^{-6}$  DALY pppy target.

|   | Data source                 | <i>Campylobacter</i> | Rotavirus <sup>a</sup> | <i>Cryptosporidium</i> |
|---|-----------------------------|----------------------|------------------------|------------------------|
| Source water (number/L)   | 95% of data from literature | 240                  | 0.5                    | 11                     |
| Pathogen concentration (number/L) in drinking-water corresponding to $10^{-6}$ DALY pppy <sup>b</sup> | –                           | $1.1 \times 10^{-4}$ | $1.1 \times 10^{-5}$   | $1.3 \times 10^{-5}$   |
| Required log removal to meet health-based target (performance target)                                 | –                           | 6.3                  | 4.7                    | 5.9                    |
| Calculated log removal  | –                           | >7.1                 | 7.0                    | >6.2                   |
| Coagulation/filtration  | Hijnen and Medema (2010)    | 2.1                  | 3.0                    | 3.2                    |
| UV  | Hijnen and Medema (2010)    | >5                   | 4.0                    | >3                     |

<sup>a</sup> Virus concentration in source water is based on literature data on culturable enterovirus.

<sup>b</sup> From Table 7.4 of the WHO GDWQ.

QMRA requires more technical knowledge and resources compared with the risk assessment approaches presented previously. The level of quantification, mathematical sophistication, time, expertise and data required depend on the level of sophistication of the QMRA. Conducting a comprehensive probabilistic QMRA requires the most resources in terms of data and specialised personnel. In practice, such comprehensive QMRAs are conducted mainly in larger utilities in high-income countries where the public health agencies have promoted the use of QMRA by providing guidance or even direct support.

## Application

QMRA calculations have historically been in the hands of specialists and researchers. The apparent complexity of the calculations has created a barrier for more widespread accessibility to the water industry. Various tools have been developed to increase accessibility of the QMRA approach to non-specialists. A range of different software platforms have been used to undertake QMRA calculations. Petterson and Ashbolt (2016) note that:

- there is currently no single QMRA tool that can meet all of the needs of the water industry
- basic training in QMRA and understanding the underlying model assumptions is necessary to support tool implementation
- there is limited value associated with a 'black box' QMRA tool, as the greatest value is not in the result alone, but in understanding the interactions between the model parameters and relative risk estimates – so you get to know your system
- more complex studies are not necessarily better, in fact, a QMRA should be as simple as possible in order to achieve the required outcomes of the analysis
- in practice, whilst the QMRA methodology is fundamentally robust, its reliability is limited by the quality of supporting data and evidence.

## References

ANSI/AWWA G100-11. 2011. *Water Treatment Plant Operation and Management* (1st edition). Denver CO: AWWA Standard, American Water Works Association.

ANSI/AWWA G410-09. 2009. *Standard for Business Practices for Operation and Management*. Denver CO: AWWA Standard. American Water Works Association.

AS/NZS ISO 9001. 2000. *Quality Management Systems – Requirements*. Standards Australia/Standards New Zealand.

AS/NZS. 2004. AS/NZS 4360:2004. *Risk Management*. Standards New Zealand.

AWWA. 1994. Overcoming natural disasters. Articles by Reid, McMullen, Murphy and Shimoda in *Journal American Water Works Association* 86(1).

AWWA. *Manual M5: Water Utility Management*. Denver CO: American Water Works Association. [www.awwa.org](http://www.awwa.org)

CDC. 2010. *When Every Drop Counts: Protecting public health during drought conditions – a guide for public health professionals*. Centers for Disease Control and Prevention, US Environmental Protection Agency, National Oceanic and Atmospheric Agency, and American Water Works Association. Atlanta: US Department of Health and Human Services, 56 pp. See <http://www.cdc.gov/nceh/ehs/Publications/Drought.htm>

Codex Alimentarius. 1993. *Guidelines for the Application of the Hazard Analysis Critical Control Point (HACCP) System*. CAC/GL 18-1993.

- DWI. 2012. *Health Impacts from Extreme Events Water Shortages*. 92 pp.  
<http://dwi.defra.gov.uk/research/completed-research/reports/DWI70-2-263.pdf>
- EnHealth. 2012. *Risky Business – A resource to help local governments manage environmental health risks*. Commonwealth of Australia, Environmental Health Standing Committee and the Australian Government Department of Health and Ageing, Canberra. 74 pp.  
<http://www.health.gov.au/internet/main/publishing.nsf/Content/health-pubhlth-publicat-envIRON.htm>
- Geldreich EE. 1996. *Microbial Quality of Water Supply in Distribution Systems*. Boca Raton: CRC Lewis Publishers.
- ISO. 2009. AS/NZS ISO 31000:2009 – Risk management – Principles and guidelines.
- MoH. *Public Health Risk Management Plan Guides*. The New Zealand Ministry of Health's Guides for drinking-water supplies can be accessed as Word documents on the Ministry of Health website: <http://www.health.govt.nz/water> then select publications and Water Safety Plans. First, read: How to prepare and develop PHRMPs.
- MoH has prepared a PHRMP Guide on Staff Training, Ref. G1.
- MoH. 2005. *Drinking-water Standards for New Zealand*. Wellington: Ministry of Health. This version was revised 2008.
- MoH. 2008. *Guidelines for the Safe Carriage and Delivery of Drinking-water*. Wellington: Ministry of Health. Available online at <http://www.health.govt.nz/water>.
- MoH. 2008. *Small Drinking-water Supplies: Public health risk management kit*. Available online at <http://www.health.govt.nz/water>.
- MoH. *Register of Community Drinking-water Supplies and Suppliers in New Zealand*. Wellington: Ministry of Health.
- NHMRC. 2012. *Australian Drinking Water Guidelines, Community Water Planner – A tool for small communities to develop drinking water management plans, Community Water Planner, User Manual*. [www.nhmrc.gov.au/guidelines/publications/eh52web](http://www.nhmrc.gov.au/guidelines/publications/eh52web) or <http://www.nhmrc.gov.au/publications/synopses/eh39.htm> or <http://www.communitywaterplanner.gov.au/resourceportal/35>.
- NHMRC. 2016. *Australian Drinking Water Guidelines*. National Health and Medical Research Council. <https://www.nhmrc.gov.au/guidelines-publications/eh52>.
- NZS. 2000. SNZ HB 4360:2000. *Risk Management for Local Government*. Standards New Zealand.
- Petterson SR, Ashbolt NJ. 2016. QMRA and water safety management: review of application in drinking water systems. *J Water Health* 14(4): 571–89.  
<https://doi.org/10.2166/wh.2016.262>.
- USEPA. 1999. *Guidance Manual for Conducting Sanitary Surveys of Public Water Systems; Surface Water and Ground Water Under the Direct Influence (GWUDI)*. EPA, United States Office of Water. EPA 815-R-99-016. Environmental Protection Agency. April. See <http://www.epa.gov/safewater/mdbp/pdf/sansurv/sansurv.pdf>.



USEPA. 2004. *Response Protocol Toolbox: Planning for and responding to drinking water contamination threats and incidents*. Module 5: Public Health Response Guide. Interim Final – April 2004. 83 pp.

[http://water.epa.gov/infrastructure/watersecurity/upload/guide\\_response\\_module5.doc](http://water.epa.gov/infrastructure/watersecurity/upload/guide_response_module5.doc).

Water UK. 2010. *Medical Surveillance of Personnel*. Technical Guidance Note No.1. 2 pp.

<http://www.water.org.uk/home/policy/publications/archive/drinking-water/principles-of-water-supply-hygiene>.

Water UK. 2010a. *Event and Incident Management*. Technical Guidance Note No.10.

5 pp. <http://www.water.org.uk/home/policy/publications/archive/drinking-water/principles-of-water-supply-hygiene>.

WHO. 2001. *Water Quality – Guidelines, Standards and Health: Assessment of risk and risk management for water-related infectious disease*. Published on behalf of the World Health Organization by IWA Publishing. This book is available on the internet at:

[http://www.who.int/water\\_sanitation\\_health/dwq/whoiwa/en/index.html](http://www.who.int/water_sanitation_health/dwq/whoiwa/en/index.html).

WHO. 2003. *Environmental Health in Emergencies and Disasters: A practical guide*.

ISBN 92 4 154541 0. Chapter 7 discusses water supply. Available on the internet at:

[http://www.who.int/water\\_sanitation\\_health/hygiene/emergencies/emergencies2002/en/](http://www.who.int/water_sanitation_health/hygiene/emergencies/emergencies2002/en/).

WHO. 2004. *Guidelines for Drinking-water Quality 2004* (3rd edition.). Geneva: World Health Organization.

[http://www.who.int/water\\_sanitation\\_health/dwq/guidelines/en/index.html](http://www.who.int/water_sanitation_health/dwq/guidelines/en/index.html) and see also the addenda (2006).

WHO. 2005. *Water Safety Plans: Managing drinking-water quality from catchment to consumer*. WHO/SDE/WSH/05.06. 244 pp.

[http://www.who.int/water\\_sanitation\\_health/dwq/wsp170805.pdf](http://www.who.int/water_sanitation_health/dwq/wsp170805.pdf).

WHO. 2007. *Chemical Safety of Drinking-water: Assessing priorities for risk management*. Thompson T, et al. 160 pp. Geneva: World Health Organization. See:

[http://www.who.int/water\\_sanitation\\_health/dwq/dwchem\\_safety/en/](http://www.who.int/water_sanitation_health/dwq/dwchem_safety/en/).

WHO. 2009. *Water Safety Plan Manual (WSP Manual): Step-by-step risk management for drinking-water suppliers*. How to develop and implement a Water Safety Plan – A step-by-step approach using 11 learning modules. 108 pp.

[http://www.who.int/water\\_sanitation\\_health/publications/en/index.html](http://www.who.int/water_sanitation_health/publications/en/index.html).

WHO. 2011. *Water Safety Plan Manual Quality Assurance Tool – User Manual*. 28 pp.

[http://www.who.int/water\\_sanitation\\_health/publications/en/index.html](http://www.who.int/water_sanitation_health/publications/en/index.html).

WHO. 2011a. *WHO Technical Notes on Drinking-water, Sanitation and Hygiene in emergencies*.

[http://www.who.int/water\\_sanitation\\_health/dwq/publications/en/index.html](http://www.who.int/water_sanitation_health/dwq/publications/en/index.html).

WHO. 2011b. *Guidelines for Drinking-water Quality 2011* (4th edition). Geneva: World Health Organization. Available at:

[http://www.who.int/water\\_sanitation\\_health/publications/2011/dwq\\_guidelines/en/index.html](http://www.who.int/water_sanitation_health/publications/2011/dwq_guidelines/en/index.html).

- WHO. 2012. *Water Safety Planning for Small Community Water Supplies Step-by-Step Risk Management Guidance for Drinking-water Supplies in Small Communities*. 66 pp. [http://www.who.int/water\\_sanitation\\_health/publications/2012/water\\_supplies/en/index.html](http://www.who.int/water_sanitation_health/publications/2012/water_supplies/en/index.html).
- WHO. 2013. *Health and Environment: Communicating the risks*. WHO Regional Office for Europe, Copenhagen. 68 pp. ISBN 978 92 890 00512. [http://www.euro.who.int/\\_data/assets/pdf\\_file/0011/233759/e96930.pdf](http://www.euro.who.int/_data/assets/pdf_file/0011/233759/e96930.pdf).
- WHO. 2014. *Water Safety Plan: A field guide to improving drinking-water safety in small communities*. WHO Regional Office for Europe. 100 pp. <http://www.euro.who.int/en/health-topics/environment-and-health/water-and-sanitation/publications/2014/water-safety-plan-a-field-guide-to-improving-drinking-water-safety-in-small-communities>.
- WHO. 2015. *A Practical Guide to Auditing Water Safety Plans*. 88 pp. Geneva: World Health Organization. Available at: [http://www.who.int/water\\_sanitation\\_health/dwq/audit-for-wsp.pdf](http://www.who.int/water_sanitation_health/dwq/audit-for-wsp.pdf).
- WHO. 2016. *Quantitative Microbial Risk Assessment: Application for water safety management*. World Health Organization. Geneva. 208 pp. [http://www.who.int/water\\_sanitation\\_health/dwq/](http://www.who.int/water_sanitation_health/dwq/) or <http://apps.who.int/iris/bitstream/10665/246195/1/9789241565370-eng.pdf?ua=1>.
- WHO. 2016a. *Protecting Surface Water for Health: Identifying, assessing and managing drinking-water quality risks in surface water catchments*. 196 pp. [http://www.who.int/water\\_sanitation\\_health/publications/pswh/en](http://www.who.int/water_sanitation_health/publications/pswh/en).
- WHO. 2017. *Guidelines for Drinking-water Quality: Fourth edition incorporating the first Addendum*. Geneva: World Health Organization. 631 pp. [http://www.who.int/water\\_sanitation\\_health/publications/drinking-water-quality-guidelines-4-including-1st-addendum/en/](http://www.who.int/water_sanitation_health/publications/drinking-water-quality-guidelines-4-including-1st-addendum/en/).
- WHO. 2018. *Strengthening Operations and Maintenance through Water Safety Planning*. A collection of case studies. 20 pp. WHO/CED/PHE/WSH/18.69. WHO/IWA. [http://www.who.int/water\\_sanitation\\_health/publications/strengthening-om-thru-water-safety-planning/en/](http://www.who.int/water_sanitation_health/publications/strengthening-om-thru-water-safety-planning/en/).
- WQRA. 2009. *Risk Assessment for Drinking Water Sources*. Research Report No 78. 65 pp. <http://www.wqra.com.au/project-details/2>.
- WRA. 2015. *Good Practice Guide to the Operation of Drinking Water Supply Systems for the Management of Microbial Risk*. Final Report – WaterRA Project 1074. Water Research Australia Limited. 52 pp. ISBN 978-1-921732-27-0. <http://www.waterra.com.au/publications/document-search/?download=1173>.
- WRF. 2016. *A Methodology for Locating and Managing Dynamic Potential Source Water Contaminant Data*. Project #4581. Denver, Colo.: Water Research Foundation. Author: Rosen et al. 175 pp. <http://www.waterrf.org/PublicReportLibrary/4581.pdf>.

# Chapter 3: Water sources

## Contents

|            |  |           |
|------------|--|-----------|
| <b>3.1</b> | <b>Introduction</b>                                      | <b>2</b>  |
| <b>3.2</b> | <b>Groundwater</b>                                       | <b>4</b>  |
| 3.2.1      | Description of a groundwater system                      | 4         |
| 3.2.2      | The quality of groundwater                               | 7         |
| 3.2.3      | Factors affecting groundwater quality                    | 13        |
| 3.2.4      | Establishing the security of a bore water supply         | 18        |
| 3.2.5      | Operations and maintenance                               | 44        |
| <b>3.3</b> | <b>Surface water</b>                                     | <b>50</b> |
| 3.3.1      | Rivers and streams                                       | 51        |
| 3.3.2      | Lakes and reservoirs                                     | 55        |
| 3.3.3      | Springs  | 58        |
| <b>3.4</b> | <b>Legislation</b>                                       | <b>59</b> |
| 3.4.1      | General  | 59        |
| 3.4.2      | National Environmental Standards (NES)                   | 62        |
| <b>3.5</b> | <b>Mitigation of pollutants and catchment protection</b> | <b>64</b> |
| 3.5.1      | Rural activities   | 65        |
| 3.5.2      | Urban and transportation pollutants                      | 70        |
| 3.5.3      | Petroleum development activities                         | 72        |
|            | <b>References</b>  | <b>73</b> |

## List of tables

|            |   |    |
|------------|---|----|
| Table 3.1: | Concentrations of enteric pathogens and indicators in different types of source water                                 | 8  |
| Table 3.2: | Statistics showing the variability in conductivity, chloride and nitrate-N for groundwaters                           | 29 |
| Table 3.3: | Example of calculations of coefficient of variation and standardised variance   | 30 |
| Table 3.4: | Log reductions of viruses in Canterbury's alluvial aquifers   | 37 |
| Table 3.5: | Human activities and associated inputs into freshwater ecosystems with human health risks                             | 51 |
| Table 3.6: | Some chemical constituents in untreated surface water used for drinking-water supply that present a potential problem | 53 |
| Table 3.7: | Faecal contamination in a range of New Zealand streams and rivers   | 54 |
| Table 3.8: | Specific yields (kg/ha/y) for different land uses in New Zealand  | 56 |

## List of figures

|             |  |    |
|-------------|--|----|
| Figure 3.1: | Atmospheric CFC and tritium concentrations in rain water | 27 |
| Figure 3.2: | Sanitary protection of a typical bore                    | 36 |
| Figure 3.3: | Catchment protection                                     | 64 |

# 3.1 Introduction

Source water is potential raw water, ie, it is natural fresh water that could be abstracted and processed for drinking purposes.

The chemical composition of natural fresh water is the end result of rainwater that has fallen on to the land and interacted with the soil, the material in or on the soil, and rocks as it moves down rivers, or into lakes, or percolates underground. Its overall quality is further modified by run-off from various land uses (non-point or diffuse sources) and by discharges (point source). The quality is modified further by biological activity, wind-blown material and evaporation.

The sections in this chapter are aimed at addressing what impacts on the quality of natural fresh waters, and what can be done to identify and limit these impacts, by taking into account recent research findings from New Zealand and abroad.

Half of the chapter discusses groundwater, including compliance issues related to demonstrating bore water security. Bore water security impacts on both bacterial and protozoal compliance. The concept of bore water security was originally developed for the DWSNZ as an alternative approach to monitoring *E. coli* at the rate required for surface water sources.

A summary of the legislation covering natural fresh water is included in this chapter.

Chapter 4 discusses the steps recommended in the selection of raw water sources and appropriate water treatment processes.

Monitoring surface source waters to determine the number of log credits required for protozoal compliance is covered in Chapter 8: Protozoa Compliance, section 8.2.

Chapter 17: Monitoring, section 17.2 discusses some aspects of water sampling and testing.

Rainwater is discussed in Chapter 19: Small and Individual Supplies.

General source water risk management issues are discussed in the MoH Public Health Risk Management Plan Guide PHRMP Ref. S1.1: Surface and Groundwater Sources; also see Chapter 2: Management of Community Supplies.

Source water quality management is discussed in Chapter 4 of AWWA (1990, new edition 2011).

WHO (2003a) is an excellent general text, some of which was used in compiling the *Guidelines for Drinking-water Quality* WHO (2004). The chapter titles are shown in Chapter 4: Selection of Water Source and Treatment, section 4.3.1.

A well-illustrated publication that describes groundwater quality protection very simply was published by the Vermont Department of Environmental Conservation in September 2005.

The AWWA's fourth edition of their manual on groundwater appeared in 2014.

The USEPA (2008) published a guidance manual related to their groundwater rule, see References.

WHO in 2012 published an excellent book *Animal Waste, Water Quality and Human Health*.

GNS produced a guideline document (Moreau et al 2014) and a technical document (Moreau et al 2014a) to assist in the delineation of protection and capture zones for bores and springs.

The Commonwealth of Australia produced a report 'Bore integrity, Background review' in 2014.

## 3.2 Groundwater

### 3.2.1 Description of a groundwater system

Unlike surface water, many of the processes that affect the quality of groundwater occur underground, out of sight, so cannot be observed directly. Our understanding of how a groundwater system works is largely obtained by deduction from indirect observation. The following sections describe the general characteristics of a groundwater system and the processes that can affect bore water quality.

Groundwater comprises about 80–90 percent of the world's freshwater resources. It is recharged from the surface, predominantly from rainfall, but can also receive leakage from rivers and lakes. Water seeps down through the soil and unsaturated formation until it reaches the water table. At this point it moves more horizontally through pores in sediments and fractures in rock. Aquifers are large areas of formation that act as reservoirs from which groundwater can be abstracted through a bore for supply.

In the DWSNZ, groundwater is considered to be the water contained in the aquifer; bore water is either in the bore or is the water that has left the bore. This distinction is necessary because previously there has been reference to secure groundwater, which led to people talking about secure aquifers. To be called secure, groundwater that has been abstracted from an aquifer through a bore to become drinking-water needs to comply with bore water security criteria 1 and 2 and 3.

Many New Zealand drinking waters originate from groundwater that enters the distribution system without any water treatment. For the water supply to remain safe to drink requires long-term protection of the aquifer, knowledge of the land-use, aquifer characteristics, and diligent day to day and long-term management.

Instead of requiring disinfection for all groundwater systems, the Ground Water Rule (USEPA 2006) establishes a risk-targeted approach to target groundwater systems that are susceptible to faecal contamination. The occurrence of faecal indicators in a drinking water supply is an indication of the potential presence of microbial pathogens that may pose a threat to public health. This rule requires groundwater systems that are at risk of faecal contamination to take corrective action to reduce cases of illnesses and deaths due to exposure to microbial pathogens. A central objective of the GWR is to identify the subset of groundwater sources that are at higher risk of faecal contamination. The primary monitoring tool is the total coliform test. The GWR does not apply to groundwater under direct influence of surface water (GWUDI) which is covered by the Surface Water Treatment Rule (SWTR).

The excellent publication by WHO (2006) reports that in the period between 1971 and 1982 untreated or inadequately treated groundwater in the US was responsible for 51 percent of all waterborne disease outbreaks and 40 percent of all waterborne illness. A recent analysis of public health data in the USA showed little change to the epidemiology of disease outbreaks.

### 3.2.1.1 Confined and unconfined aquifers

If a layer of relatively saturated impermeable material (an aquitard) overlies an aquifer, the system is known as a confined aquifer. The aquitard acts as a protective layer, often minimising or preventing further vertical movement of contaminants into the aquifer. Aquitards can also reduce the vertical interchange of water between aquifers at different depths. Where an aquitard is patchy or lacking (eg, tapers out) an aquifer may be more vulnerable to contamination from the ground surface ie, no longer confined, or springs can emerge at the ground surface. Springs can be contaminated directly from surface sources, and can act as conduits for contaminants to move down into the underlying groundwater particularly if they dry out during dry periods.

An unconfined aquifer is so called because of the absence of a confining aquitard layer (eg, clay). In contrast to a confined aquifer, it is relatively vulnerable to contamination from the land surface. For the purposes of the *Drinking-water Standards for New Zealand 2005 (revised 2008)* (DWSNZ), when planning a drinking-water quality monitoring programme, unconfined groundwater systems less than 10 m deep should be regarded as being probably no safer than surface sources. Bores drawing from unconfined aquifers greater than 10 m deep may possibly be able to demonstrate security, but require more monitoring than if drawn from a confined aquifer.

When a bore is sunk, the drillers should collect substrate samples at different depths for inspection; this is called the bore log. When a bore is installed it is often pump tested for a prolonged period to establish the volume of water that it can supply. Bore logs and pumping test information from observation bores will often show whether an aquifer is confined, particularly adjacent to the bore. However, it doesn't show how extensive the confining layer is, or whether it offers consistent protection of the aquifer over a wide area. The regional council may have additional data on file that may help to understand the whole aquifer. The confining layer only protects the water from what is happening above it; contamination from the surface nearer the recharge area can still occur.

Knowledge of the water levels in a bore can also indicate whether an aquifer is confined. Note that for DWSNZ purposes, depth is the length of casing to the top of the shallowest screen, not the total depth. Bores that are naturally free-flowing (artesian) are generally indicative of confined aquifer conditions, at least locally. This upward flow of groundwater that provides some natural aquifer protection can, however, be reversed during pumping, droughts, or intermittent use upslope.

USEPA (2008) describes 14 indicators of confinement and the characteristics used to identify the presence of a confining layer.

### 3.2.1.2 Groundwater flow

By measuring the depths of the water in a number of bores relative to a common datum, eg, seawater level, the depths in the various bores can be contoured to produce a map of the water table (unconfined aquifer) or piezometric surface (confined aquifer). Groundwater generally moves at a much slower rate than surface water. It seeps through the pores of sediments or fractures in rock, down-gradient from areas of high elevations to areas of low elevation. Eventually it discharges to rivers, lakes, the sea, or through springs.

Groundwater flows in the direction of greatest downhill slope or gradient (ie, perpendicular to the equal elevation contours on the water table or piezometric map).

The slope of the water table ( $i$ ), the effective porosity of the aquifer ( $n$ ), and the amount of water flowing through the pores (flow volume per unit time,  $Q$ , divided by the cross-sectional area through which it moves,  $A$ ) can be used to determine the average linear velocity of the groundwater,  $v$ , using the D'Arcy equation:

$$v = Q/(nA) = K i/n$$

where  $k$  is the hydraulic conductivity of the aquifer.

The velocity,  $v$ , is known as the average linear velocity because it describes the gross flow rate through the aquifer material. Aquifers are not homogeneous but may, for example, consist of lenses of finer material (clay, silts or sands) alternating with coarser materials (gravels), such as in Heretaunga (Hawkes Bay), the Canterbury Plains and Waimea (Nelson). These have built up from braided rivers. Groundwater movement through these systems will be quicker through the coarser material than through the finer material. Consequently contaminants in the groundwater can be transported much faster through parts of the aquifer (up to 50 times) than is indicated by the average linear velocity. In addition, localised flow through the buried channels can deviate significantly from the presumed down-gradient flow direction. Consequently, care must be taken in assuming the rate and direction of the groundwater movement through non-homogeneous aquifers.

Tracer tests may be useful in determining the localised groundwater flow rate and direction. An easily detectable tracer can be introduced into the aquifer through an injection bore and its progress determined directly by measuring its concentration in samples of groundwater from down-gradient bores (or possibly indirectly, by geophysical techniques such as surface resistivity using a salt tracer). Flow direction, velocity, dispersion and attenuation characteristics can be estimated by measuring spatial and temporal variations of tracer concentrations. However, the cost of drilling bores is often high, the data interpretation complex and tracer selection critical. Tracer tests should only be carried out by an experienced hydrogeologist.

The temperature of water in very shallow aquifers (eg, less than about 10–15 m deep) may vary seasonally but deeper groundwater temperature remains relatively constant. This is why water from a bore may seem relatively warm in winter or cool in summer. Water temperature provides a useful means by which to infer river – groundwater interactions and can potentially be applied to reduce the uncertainty of aquifer recharge estimates (ESR 2016).



The effective insulation of deeper groundwater from temperature changes also occurs in respect of contaminants. Contaminants in an aquifer are not flushed from their source in the same manner or as quickly as surface water. Unless contaminants attenuate through die-off (microbial), decay or adsorption, they will be retained and move through the aquifer system, potentially affecting the use of the groundwater along its flowpath and probably for a considerable time.

Most groundwater supplies need to be pumped. Risk management issues related to pumping are discussed in the MoH Public Health Risk Management Plan Guide PHRMP Ref. P4.2: Treatment Processes – Pump Operation.

## 3.2.2 The quality of groundwater

Groundwaters are generally of better microbiological quality than surface waters because of the range of mechanisms active under the ground that can attenuate the microbial contaminants initially present in the water. Moreover, changes in microbiological quality that occur are not as large or as rapid as those in surface waters. Although some aspects of the chemical quality of groundwaters may be a concern, these characteristics of the microbiological quality of groundwater often mean they are more preferable source waters than surface waters. However, once a groundwater becomes contaminated by chemicals, it takes a long time before the contamination is flushed out.

Table 3.1, copied from the WHO *Guidelines for Drinking-water Quality* (2004), provides a comparison of the levels of pathogens and indicator organisms found in surface and groundwaters.

The levels of microbial contamination in a particular water source will depend, amongst other things, on the nature of contamination sources in the catchment or recharge zone, and the barriers between these contamination sources and the water source. New Zealand source waters tend to exhibit much lower numbers per litre than appear in Table 3.1.

Tests undertaken over a period of time long enough to show seasonal variation are required to establish the microbial quality of a groundwater source. It is advantageous to consult someone familiar with the groundwater in the area for guidance about the most appropriate time to sample. A good reference on sampling groundwaters is *A Guide to Groundwater Sampling Techniques* by L Sinton, published by the National Water and Soil Conservation Authority as Water and Soil Miscellaneous Publication No. 99. Refer also to Sundaram et al (2009).

**Table 3.1: Concentrations of enteric pathogens and indicators in different types of source water**

| Pathogen or indicator group, per litre | Lakes and reservoirs | Impacted rivers and streams       | Wilderness rivers and streams | Groundwater       |
|--|----------------------|-----------------------------------|-------------------------------|-------------------|
| <i>Campylobacter</i>                   | 20–500               | 90–2500                           | 0–1100                        | 0–10 <sup>a</sup> |
| <i>Salmonella</i>                      | –                    | 3–58,000<br>(3–1000) <sup>b</sup> | 1– 4                          | –                 |
| <i>E. coli</i> (generic)               | 10,000–1,000,000     | 30,000–1,000,000                  | 6,000–30,000                  | 0–1000            |
| Viruses                                | 1–10                 | 30–60                             | 0–3                           | 0–2               |
| <i>Cryptosporidium</i>                 | 4–290                | 2–480                             | 2–240                         | 0–1               |
| <i>Giardia</i>                         | 2–30                 | 1–470                             | 1–2                           | 0–1               |

a Should be zero if bore water secure.

b Lower range is a more recent measurement.

Groundwaters are not usually in direct contact with faecal material, as surface waters may be, but rainfall and irrigation provide means by which surface contamination can be carried into the groundwater. In some countries groundwaters have been contaminated by the very bad practice of pumping wastes down disused bores. The vulnerability of aquifers to microbial contamination is increased by (Sinton 2001):

- recharge water coming into contact with microbial contamination
- higher porosity aquifer media, which allow greater penetration and transport of microbes, see section 3.2.4.3
- shallow aquifer depth
- absence of a confining layer
- light overlying soils and porous subsoil strata, which reduce the efficacy of processes removing microbes in these layers.

Close et al (2008) tested multiple shallow bores (4.6 to 15 m deep) in South Canterbury to show the effects of intensive dairying and border-strip irrigation on the leaching of *Campylobacter* and *E. coli* to shallow groundwater. *E. coli* was detected in all bores, ranging from <1 to 2400 MPN/100 mL, the average for all bores was 40 MPN/100 mL, the median 2 MPN/100 mL. The mean level of *E. coli* in the individual bore samples ranged from 6 to 137 MPN/100 mL. Over the three years *Campylobacter* was detected in samples from each of the bores on at least two sampling occasions with levels ranging from 0.6 to .3.1 MPN/L. *Campylobacter* were detected in 16 out of a total of 126 samples, an overall detection rate of 12%. *Campylobacter jejuni* were isolated in 11 samples and the remaining 5 were thermophilic *Campylobacter sp.* other than *C. jejuni* or *C. coli*.

In many areas of the world, aquifers that supply drinking-water are being used faster than they recharge. Not only does this represent a water supply problem, it may also have serious health implications. In coastal areas, aquifers containing potable water can become contaminated with saline water if water is withdrawn faster than it can naturally be replaced. The increasing salinity makes the water unfit for drinking and often also renders it unfit for irrigation. To remedy these problems, some coastal authorities have chosen to recharge aquifers artificially with treated wastewater, using either infiltration or injection. Aquifers may also be recharged passively (intentionally or unintentionally) by septic tanks, wastewater applied to irrigation and other means. Aquifer recharge with treated wastewater is likely to increase in future because it can:

- restore depleted groundwater levels
- provide a barrier to saline intrusion in coastal zones
- facilitate water storage during times of high water availability.

If aquifer recharge is haphazard or poorly planned, chemical or microbial contaminants in the water could harm the health of consumers, particularly when reclaimed water is being used. For a full discussion, see WHO (2003b).

The layer of unsaturated soil above the groundwater plays a major role in reducing the numbers of micro-organisms found in groundwaters. Factors affecting the survival of organisms (ie, how rapidly the organisms die off), and those influencing their transport (ie, how quickly they are carried through the unsaturated strata) both affect the levels of microbes reaching the groundwater.

Several studies demonstrate a considerable degree of variability between the inactivation or die-off rates of different groups of pathogens, and between inactivation rates of the same organism in different environments. However, as a general rule, enteric viruses persist longer in soils than bacteria. Among the enteric viruses, hepatitis A virus appears to be the most resistant to inactivation in soil and, in laboratory experiments, shows a lower capacity for adsorption to particle surfaces. The oocysts of *Cryptosporidium* are highly resistant to environmental stress and it has been estimated that they could be detected after 12 months in soil (WHO 2006).

Bacterial survival in soils is improved by (Sinton 2001):

- high soil moisture
- greater penetration into the soil profile
- low temperatures
- low pH values (in the range 3–5)
- high organic matter content
- low numbers of antagonistic soil microflora.

The most important attenuating processes for bacteria in soils are filtration and adsorption (Sinton 2001). The effectiveness of filtration is greatest in soils with low particle size, while some sedimentation can occur in zones where there is virtually no flow of water. Media providing large surface areas, such as clays, improve contaminant adsorption. The adsorption process is enhanced by conditions that minimise electrostatic repulsion between the micro-organism and surfaces to which they might adsorb. Increased levels of dissolved solids in the water assist in suppressing

electrostatic repulsion, consequently rainwater, which contains little dissolved material, assists microbes in penetrating further into the ground.

Filtration and sedimentation, which are influenced by the size of the contaminant, are less important in the removal of viruses in soils, because viruses are very much smaller than bacteria. WHO (2006) reports results of a study that set out to determine the extent and penetration of microbial contaminants in the Triassic Sandstone aquifer underlying Birmingham and Nottingham in the United Kingdom. It found:

- sewer leakage-derived microbial contaminants are able to penetrate sandstone aquifers to significant depths (>90 m)
- human enteric viruses, including pathogenic species are widespread in the aquifer
- the species of sewage-derived human enteric viruses in groundwater are found to vary temporally, and in parallel with their predicted prevalence in the population. The dominant types found in March and June 2001 were noroviruses and Coxsackievirus B4 respectively
- particular horizons at depth within the sandstone aquifer were found to be rapidly susceptible to microbial contamination (ie, contaminant distribution is vertically and temporally heterogeneous).

Processes active during transport in groundwater further attenuate the levels of microbes that reach the water table. These mechanisms are similar to those active in removal in soils. However, the increased size of aquifer media, and the resulting larger pore sizes, and the higher water velocities in aquifers than through soils, result in filtration, sedimentation and adsorption being less effective. Transport distances are much greater in aquifers than soils.

The absence of sunlight (with its UV light) in the groundwater environment is an important factor leading to the differences in the rates of microbial inactivation in groundwaters and surface waters.

Organisms can be found at great depths. In karst regions, microbes and invertebrates can be found in caves and other openings 100 metres or more beneath the surface. Bacteria can exist in some groundwater thousands of feet below the land surface. However, invertebrates are typically found within 1 to 10 metres of the surface in consolidated materials, in what is called the hyporheic zone. Within this shallow groundwater zone, many macroscopic invertebrates have been identified. Furthermore, the species richness and community structure of these organisms has been shown to change with alterations in groundwater quality. Therefore, the relative presence or absence of different communities or populations of organisms may reflect the impact of changes in regional groundwater quality. As a result, the organisms living within the shallow groundwater zone can serve as indicators of the quality of the groundwater resource. Macroinvertebrates living in the hyporheic zone, such as oligochaetes, isopods, and ostracods, have evolved special adaptations to survive in a food-, oxygen-, space-, and light-limited environment (USEPA 1998). Sinton (1984) described macro-invertebrates observed in a polluted Canterbury aquifer.

**Health-significant chemical determinands** may appear in waters from natural sources, as well as human activities. The naturally-occurring chemical determinand that appears most frequently at potentially health significant concentrations (greater than 50 percent MAV) in drinking-water sources in New Zealand is arsenic. Groundwaters in geothermal areas often contain arsenic and boron at concentrations above drinking water MAVs. Arsenic is also detected in groundwaters in other parts of the country, although generally at lower concentrations than in obviously geothermal areas (Nokes and Ritchie 2002). Higher arsenic concentrations are often associated with anaerobic (poorly oxygenated) groundwaters. Although arsenic may appear in association with iron and manganese, the presence of these metals in a groundwater does not imply the presence of arsenic. In some groundwaters, the presence of arsenic is thought to arise from the contaminant being leached from old marine sediments.

**Arsenic** has been observed to vary substantially with season, particularly in shallow bores (Frost et al 1993). Measurements should therefore be undertaken under a range of seasonal conditions. Further, the occurrence of arsenic in groundwaters is not always predictable, and tests for arsenic should be included in the investigation of any new groundwater source.

**Boron** is found in association with arsenic in geothermal areas. It can also appear at high concentrations in the absence of arsenic in some geothermally influenced (hydrothermal) springs, eg, near Auckland; few of these occurrences result in boron exceeding 50 percent of its MAV.

**High nitrate** concentrations occur in drinking-water sources in a number of areas in New Zealand. It has a number of possible sources, all related to human activities, such as: fertiliser application; disposal of wastewater from dairy factory operations; high grazing densities of dairy stock. It can also be found at high concentrations on a localised scale due to on-site waste disposal systems (eg, septic tanks). Ammonia is the commonest nitrogen compound in anaerobic water.

There is typically an increased leaching of nitrate from soils with increased rainfall or rising water table levels. In these cases, the highest nitrate concentrations will be found when the water table is highest, ie, usually in the winter and spring. Landcare Research has produced a National Map of Nitrate Leaching, see:

<http://www.landcareresearch.co.nz/science/soils-and-landscapes/ecosystem-services/factsheets>.

**Fluoride** is often found overseas as a groundwater contaminant of health significance, but fluoride in excess of 50 percent of its MAV has been found in only three water supplies in New Zealand (Ritchie 2004). Slightly elevated levels of fluoride can be found in geothermal areas, and in some geothermally influenced (hydrothermal) waters.

**Pesticides** have been found in a number of vulnerable New Zealand groundwaters (Close and Flintoft 2004; MAF 2006). Pesticides in excess of 50 percent of a MAV have been found in only two drinking-water supplies (Ritchie 2004). Dieldrin was the detected pesticide in both cases. Refer to individual pesticide datasheets for details.

A nationwide study of more than 1000 shallow bores and springs in the USA found that one or more pesticides were detected in more than half of the samples collected. 95 percent of the pesticide detections were at concentrations less than 1 µg/L. The most commonly detected pesticide was atrazine, reflecting both the widespread use of this chemical in agriculture, and its chemical stability and mobility in soil and groundwater. Investigations at pesticide mixing sites in Western Australia detected a range of pesticides in groundwater including atrazine, chlorpyrifos, diazinon, dimethoate, fenamiphos, maldison, aldrin, chlordane, DDT, dieldrin and heptachlor. The most commonly detected pesticide in groundwater was diazinon, which was detected in 63 of the 78 groundwater samples collected at concentrations ranging between 0.1 and 4 µg/L (from WHO 2006).

**Manganese** is a health-significant determinand, but it can also adversely affect the aesthetic properties of water. It is a naturally-occurring determinand, which dissolves into groundwater under oxygen-deficient, low pH conditions. Such conditions often arise in shallow groundwaters as the result of the respiration of microbes in the sub-surface media through which the water passes. During respiration organisms withdraw oxygen from the water and return carbon dioxide as a waste product. The carbon dioxide dissolves to form carbonic acid, thereby depressing the pH of the water and dissolving the manganese, particularly when the water is anaerobic. Some source of organic matter, such as peat, may be associated with the appearance of manganese, as the organic matter provides a source of carbon, which is required as a nutrient by the microbes.

**Iron**, which is of aesthetic but not health importance, is also mobilised from minerals under conditions similar to those that will mobilise manganese, and the two are often found together. The conditions that lead to the appearance of iron and manganese can be very localised. New groundwater sources should therefore be tested for both metals, rather than relying on results from nearby bores as an indicator of likely water quality. Iron and manganese concentrations may also vary significantly with time, particularly in shallow unconfined groundwater.

Complexation of iron or manganese with organic matter also present in the groundwater can inhibit the effectiveness of treatment processes designed to remove these metals from the water.

**Calcium and magnesium** are two major cations that can occur at high concentrations in groundwaters that have been in contact with calcareous rocks, such as limestone (chalk) and marble. These cause water hardness, which can lead to problems of scale formation on hot surfaces, and difficulty in getting soaps to lather.

Bores sited near the coast may undergo varying degrees of seawater intrusion, depending on the level of pumping, phase of the tide, distance to the sea, and the ease with which seawater can intrude into the aquifer. This phenomenon can lead to high concentrations of chloride and sodium, and elevated concentrations of calcium, magnesium, all of which may adversely affect the aesthetic properties of the water. It can be very difficult to reverse the process. High levels of sodium and potassium can also occur if the bore draws from old marine deposits.

## 3.2.3 Factors affecting groundwater quality

### 3.2.3.1 The water source

Because contaminants that may have infectious or toxic properties can remain in the aquifer for a considerable time and affect its use, operators of groundwater-sourced drinking-water supplies should take every precaution to prevent contamination of the aquifer. Water managers should assess the potential for contamination arising from possible sources located in the immediate area of the bore (although some plumes, eg, nitrate plumes, can travel many kilometres). All possible precautions should be taken to protect the water supply from all potential impacts. Examples of sources include: stores of hazardous substances, underground storage tanks such as at petrol stations, effluent discharges, septic tanks, waste ponds, landfills, offal pits, application of pesticides or animal wastes to nearby land. As part of this assessment, advice should be sought to determine the protection and capture zones of supply bores (Moreau 2014, 2014a). This takes into account groundwater flows, drawdown effects and attenuation characteristics, see section 3.2.4. Note that contaminants that are not soluble in water will float on the top or sink to the bottom of the aquifer.

Under the Resource Management Act 1991 regional and unitary authorities have responsibilities for the management of water bodies in their region, including groundwater; water suppliers should be able to obtain information from them about their aquifers. The National Environmental Standard for Sources of Human Drinking Water (NES) is a regulation made under the Resource Management Act (1991) that sets requirements for protecting sources of human drinking water from becoming contaminated. It came into effect on 20 June 2008.

Some groundwater systems receive water from more than one source, and if these are not consistent, water quality may vary. For example, as observed in parts of Canterbury, an aquifer may be fed from a river system and from rainwater. The groundwater quality and composition will vary depending on the preceding and current river flow and rainfall conditions, and may even depend on the state of the river bed, and the land-uses in the recharge area.

In areas without reticulated sewerage, sewage is usually discharged into septic tanks. Micro-organisms in the liquid discharge from septic tanks or other systems are likely to enter shallow unconfined aquifers. Good design and maintenance of septic tanks can reduce the threat of microbiological contamination of aquifers from this source. Sewage discharges have been known to find their way directly into aquifers via abandoned bores or soil-absorption or soakage systems receiving the effluent from septic tanks. New bores should be drilled on higher ground than where the septic tank discharges, and should be cased to sufficient depth to prevent contaminated water mixing with the deeper groundwater. Some metal casings can have a surprisingly short life due to the corrosive effect of the high carbon dioxide content in the subsoil water. Most states in USA require a minimum of 50 feet separation between a bore head and a septic tank discharge, livestock yards, silos, and 250 feet from manure stacks, see section 3.2.4.3.

If the average groundwater travel time from the aquifer fed by a septic tank is (say) 10 years, then it is likely that all pathogens will be inactivated during their residence in the subsurface, and it is likely that the groundwater is not at risk. If the average groundwater travel time is two years, then some groundwater will take a fast path and arrive in one year or less, and other groundwater will take a slower path and arrive in three years or more. Because pathogens remain infectious in the subsurface for a maximum of about one year, the health risk depends on the proportion of groundwater that arrives most rapidly at the bore (USEPA 2008).

Other possible sources of microbiological contamination include seepage from sewers, landfills, and land application of domestic and animal effluent.

One potentially major pathway for contamination often overlooked is the conduit provided by a poorly sealed bore, particularly during a flood or after heavy rain. Contaminants can enter directly down the bore shaft or down the junction between the casing and the soil. To protect the groundwater against this source of contamination it is essential to design and construct the bore head to protect against such contamination from the surface, see Figure 3.2 and section 3.2.4.3). Bores should be secured in this manner regardless of the use made of the groundwater abstracted from them. Groundwater contamination can persist for a long time and affect a large area.

Contamination can also enter the aquifer when deep piles are drilled through the aquitard without due protection, or even a telegraph pole, if the protecting layer were very shallow, somewhat like a puncture. Regional and unitary authorities should be aware of old or disused bores. Old bores that have been shut down need to be located and inspected and the bore head repaired if necessary.

A nearby non-secure bore head is not necessarily part of the water supply itself, however, it is a potential threat to the supply that needs to be managed through the supply's water safety plan, just as any other potential contamination source in the capture zone would be.

A distinction needs to be made between a threat to the "secure" status of a bore and a threat to the quality of water produced from the bore. Threats to the water quality from secure bores should be managed through the water safety plan, rather than modifying the "secure" status of the bore. Factors that determine the level of risk a non-secure bore presents to a groundwater source include the:

1. location of non-secure bores with respect to the capture zone. of the neighbouring bores(s) and the number of non-secure bores within the capture zone (Moreau et al 2014/2014a)
2. amount of contaminant/surface water likely to enter the aquifer
3. frequency at which this may occur.

Management of the risk associated with threats to bore water quality, which include non-secure bore heads, should be made through water safety plans. DWAs and water suppliers may find the advice below helpful in managing risks to bore water quality.



- a. Water suppliers need to do their best to establish what threats, including non-secure bore heads, to the quality of their bore water exist. Help from outside agencies, such as regional councils who hold catchment/capture zone information and also have responsibility for source water protection through the RMA and NES for sources of human drinking water, should be sought, including the location of disused bores.
- b. To determine the area in which a threat may affect the quality of the water from their bore, a water supplier needs to delineate the source bore(s) capture zone(s). The GNS report, *Capture Zone Guidelines for New Zealand* (Moreau et al 2014) defines a capture zone as: the total area that contributes water to the bore. It follows from this definition that, in principle, any contaminants from a threat within the capture zone could eventually reach the bore of interest. Because of mechanisms removing or inactivating pathogens, including die-off, during their subsurface transport, the concept of a protection zone may be helpful. The GNS report defines a protection zone as the portion of the zone that has a defined travel time for groundwater to arrive at the bore. This could take account of microbial die-off, although it may be more difficult to delineate if hydrological data are scarce. Where there is uncertainty about defining a protection zone, the water supplier should delineate the capture zone to ensure all possible threats that may affect their source have been identified. The health significance of these threats can then be estimated and the need for risk management strategies determined.
- c. Approaches to delineating capture zones can vary in their level of sophistication. The level of sophistication influences the time and cost of the approach. In selecting an approach to delineation, the water supplier needs to assess the severity of the consequences of the delineation being inaccurate. A simple approach to capture zone delineation (Moreau et al 2014a) should be used as a starting point, as it generally produces the largest capture zone. If there are no threats known within the most simply-defined capture zone, then this approach is probably adequate. However, if the delineated zone contains a threat, or a threat exists close to the margins of the delineated zone, then a more sophisticated approach to zone delineation should be used to obtain a more accurate assessment of the risk.
- d. If the risk that a threat presents, such as a non-secure bore head, cannot be readily assessed (ie, there is no information on the level of contamination that the threat may introduce into the aquifer or how frequently this may occur), then the supplier should carry out monitoring to help make this assessment. The most efficient and effective way of doing this is to focus sample collection on times when the risk is at its greatest, ie, when the pathways by which contaminants are transported into the aquifer are likely to be active, eg, during and following heavy rain. This approach offers the greatest likelihood of determining whether a threat can affect a bore's water quality. A 'passive' approach to sampling, ie sampling regularly at set intervals, has a reduced chance of detecting contamination of the bore. The risks to water sources need to be actively managed.
- e. Bore-construction materials deteriorate with time. As a result, it should not be assumed that once a bore head is classified as secure, it will always be so. For this reason, the security of bore heads, both of secure bores and bores that are not classified as secure within the capture zone, should be checked at appropriate intervals.

Groundwater in coastal areas is prone to high salt levels. This is likely to be caused by seawater intrusion into the aquifer, salt drift, or possibly dissolution of salt deposits. The quality of groundwater supplies subject to seawater intrusion may change in association with pumping, other users, water level variation and tidal cycles. Pattle Delamore (2011) developed national guidelines for managing the risk of seawater intrusion; many examples of management in New Zealand are included.

Geological events such as earthquakes and volcanic eruptions have the potential to change the chemical and microbiological quality of a groundwater. These events can dislocate aquifers so that previously confined aquifers are no longer protected from the influence of surface events, or the source aquifer receives groundwater from other, previously separate aquifers. Fissures, resulting from volcanic eruptions, may also allow the introduction of contaminants into the source aquifer. Rutter (2018) discussed changes observed in groundwaters in Canterbury, Marlborough and Wellington following the Darfield and Kaikoura earthquakes. Groundwater levels at different depths converged after the Darfield earthquake, indicating closer hydraulic connection between aquifer layers.

Infrastructure damage can occur too. See ESR (2012) for a literature review of the impacts of earthquakes on groundwater quality. Note that following the earthquakes in Christchurch, 20 of the 174 deep bores needed to be redrilled and 82 needed repairs. See section 3.2.5. Aqualinc (2011) also issued a report on the impacts of the Canterbury earthquake on groundwater resources.

Daughney and Wall (2007) provided a summary of groundwater quality state and trends in New Zealand based on data collected from 973 sites over the period 1995 to 2008. The dataset includes sites in State of the Environment (SOE) monitoring programmes operated by regional councils and the National Groundwater Monitoring Programme operated by GNS Science. This study is intended to be ongoing.

As the above discussion explains, there are many reasons why the quality or composition of a groundwater source may change. It is recommended that sufficient determinands be tested at an appropriate frequency to confirm that the bore water quality remains as expected. Six monthly testing would normally be sufficient for observing long-term changes. The principle determinands in most bore waters are chloride, alkalinity, silica, sodium, calcium and magnesium. Online monitoring would provide even better information. Determinands that are relatively easy to measure online include conductivity, temperature and turbidity. Bore water from large deep aquifers usually have a very consistent composition. Results should be examined for long-term trends, changes in ratios of determinands.

Short-term variations can be detected by an increase in dissolved oxygen concentration which indicates ingress of surface water into the aquifer. Surface water in the summer will usually be warmer than the groundwater, but colder in the winter, so a change in the seasonal temperature pattern can also indicative of surface water ingress. The appearance of total coliforms must also indicate contamination from the surface.

### 3.2.3.2 Changes in the unsaturated zone

The composition of the water will probably change during its percolation through the unsaturated zone. Mineral or organic matter may dissolve from the substrates that the water passes through. Groundwater in low rainfall regions is generally harder and more mineralised than water in regions with high annual rainfall that will receive more dilution, although hardness tends to be associated more with limestone areas.

In the unsaturated zone, particulate matter and some micro-organisms may be filtered out, and dissolved constituents adsorbed or absorbed from the water. The effectiveness of the filtration process in making the water biologically safe depends on the characteristics of the substrates. Filtration can be very effective where the soil and rock consists of thick layers of fine particles. Where soils are thin, eg, overlying some gravel aquifers of the Canterbury Plains, or where the unsaturated zone is coarse, or fractured (some volcanic areas of Auckland), filtration can be almost non-existent. In areas where the groundwater table is shallow, the groundwater is unlikely to be microbiologically safe. USEPA (2008) defines karst, fractured bedrock and gravel aquifers as 'sensitive'; the greater the sand content, the less 'sensitive' the aquifer.

### 3.2.3.3 Changes in the aquifer

The natural variation in groundwater quality must be established through baseline assessment in order to be able to attribute future contaminants to a new development or activity. The length of baseline monitoring and the frequency of sampling must be sufficient to establish the natural variability of groundwater quality in the area. A minimum of two years baseline data is recommended in ANZECC ARMCANZ (2000) but to establish natural variability a longer period may be required in some areas. This baseline groundwater quality data is needed to implement an effective monitoring programme. Trend analysis of individual determinands or suites of contaminants, and periodic mapping of groundwater quality over time, can be useful tools for understanding groundwater quality variations due to either natural processes or anthropogenic causes. NWQMS (2013). Chapter 14 of WHO (2006) is devoted to the assessment of pollution potential.

It is more difficult for contaminants to get into groundwater than into surface water. Once there, however, it is more difficult for the contaminant to be removed. The characteristics of the contaminants, the rate of groundwater flow through the aquifer, and the type of material the aquifer is composed of, will all influence whether the contaminants will attenuate through die-off, decay, adsorption or dispersion.

Once in the aquifer, the quality of the groundwater may change due to its interaction with the matrix or by mixing with other groundwaters. Sediments like sand may act as a filter and remove some types of contaminants from the groundwater as it flows through the aquifer. Fractured or karst (limestone exhibiting dissolution features) aquifers offer little filtration or adsorption of contaminants, but due to a localised higher pH, chemical reactions may occur. In the absence of recontamination, the bacterial quality of the water in an aquifer will usually improve during storage because of die-off due to unfavourable conditions. Passage through aquifer media will also reduce levels of viruses and protozoa, although the rate at which they are inactivated is much slower. WHO (2006) reports that straining has been identified as the principal

mechanism for controlling the migration of *Giardia* and *Cryptosporidium* species (*Cryptosporidium* oocysts: 4–6 µm; *Giardia* cysts: 7–14 µm) through fine-grained soil types. Experience has shown that up to 99 percent of *Cryptosporidium* oocysts are retained in the upper layers of the soil. However, the isolation of *Cryptosporidium* and *Giardia* from a small but significant number of groundwater sources in the USA and the UK indicates that the protective effect of the soil layer is frequently evaded, probably by migration through preferential pathways or bypassing; for example, from sewers that are often located below the soil zone.

Simultaneously, the rocks may be releasing minerals into solution or exchanging ions with those in the water.

If iron and manganese are present, the water from the tap may be clear initially while these are in a reduced state but, once dissolved oxygen is present in the water, they can oxidise to coloured forms (generally rusty or black), which may be insoluble and settle out.

Deeper aquifers are more likely to contain higher concentrations of minerals in solution because the water has usually had more time to dissolve the minerals from the surrounding rock material.

Groundwater may contain significant concentrations of naturally occurring radiological determinands, notably radon. Section 9.4 of the DWSNZ requires an initial radiological test of new bores, thereafter testing 10-yearly. See section 11.3 of Chapter 11: Radiological Compliance for further discussion on monitoring requirements, and individual datasheets.

### 3.2.4 Establishing the security of a bore water supply

To demonstrate bacterial compliance of water leaving each treatment plant (or entering the distribution system), a water supply serving a population of 10,000 or more needs to be monitored for *E. coli* daily. Section 4.3.2.1 of the DWSNZ allows compliance to be demonstrated without *E. coli* monitoring, subject to certain requirements being met, the main one being a continuous and adequate residual of chlorine. A partial concession has also been made for water supplies using groundwater sources, provided all three bore water compliance criteria are satisfied. An added advantage is that secure bore waters are also considered to satisfy the protozoal compliance criteria.

There is a range of approaches that could be used to assess groundwater vulnerability (ANZECC 1995, and see 2010 review). These include subjective rating systems, statistical and process-based methods. An example of a subjective rating system is DRASTIC (Aller et al 1987). This is a system developed by the US National Water Well Association and the USEPA which rates vulnerability subjectively, based on seven hydrogeologic setting factors. Such a system, while useful as a general indication of potential contamination from the ground surface, is not specific in respect to microbial risk.

An example of a statistical approach is that used for groundwater protection in the Netherlands (Schijven and Hassanizadeh 2002). It uses the Monte Carlo method in uncertainty analysis of factors influencing viral transport. This is used to determine the minimum size of bore head protection zones. Considering the large variation in New Zealand aquifer parameters such application is unlikely to be simple without being overly conservative. Information about viral transport in New Zealand is also limited. Groundwater protection zones are discussed extensively in Chapter 17 of WHO (2006).

Other process approaches such as deterministic models tend to have large data requirements and be situation specific. A useful summary of such methods and their hybrids is provided by Focazio et al (2002). While this is an area of continual development, a pragmatic approach is currently needed.

In the US, a tool, Hydrogeologic Sensitivity Assessment (HSA), is used to determine the pathogen sensitivity of a bore or bore field. The HSA uses all available data to assess the presence of hydrogeologic barriers at public water system bore(s) with detected *E. coli*. The definition of hydrogeologic barrier used is broad and includes any "physical, biologic, or chemical factors, singularly or in combination, that prevent the movement of viable pathogens from a contamination source to a water supply bore". The HSA approach focuses on identifying recharge pathways and the hydrogeologic barriers that provide natural filtration at specific sites. Then, relative barrier values are selected to represent natural filtration effectiveness for eliminating pathogens for each hydrogeologic barrier. Finally, the barrier values are summed to generate a Barrier Index, which provides a relative measure of the risks of pathogen migration at a specific site. The continuum of pathogen sensitivity is divided into pathogen-sensitive, intermediate pathogen-sensitive and pathogen non-sensitive categories. This approach is described in Ohio EPA (2014).

The current DWSNZ approach using water dating or water quality variation criteria, along with consideration of bore head protection is based on a reasonable assumption that groundwater isolated from surface contamination is unlikely to contain pathogenic micro-organisms. Advantages of the current approach include that it is pragmatic, being easily applied with minimal information and is empirically derived from local information. It has also been supported through public submission.

While the term 'secure' bore water is used, it simply relates to a lower level risk of microbial contamination such that less frequent monitoring is justified. It does not indicate that it is 'secure' from other forms of contamination or ultimately from all risk of microbial contamination via preferential pathways. In this respect it is a misnomer for which in time an alternative label reflecting the different levels of risk may be introduced.

Sinton (in Rosen and White 2001) collated information from regional councils about microbial contamination of New Zealand aquifers. In general, contamination was reported from bores extracting groundwater from less than 30 m below the ground surface. Septic tank discharges and poor bore construction were implicated in much of the contamination.

Some bore water supplies can never be considered secure. The DWSNZ specifically state that a secure status will not be given to bores drawing from unconfined aquifers when the intake depth is:

- less than 10 m below the surface, or
- 10–30 m below ground surface, and there is less than five years' monitoring data showing no *E. coli* contamination exists.

Secure bore waters are often those drawn from confined aquifers. However, when the water table in an unconfined area is at a great depth below the land surface, the water may be free from microbiological contamination even though it is unconfined, because of the time it takes for contaminants to move down to that depth through the aquifer materials. However, depth alone does not necessarily lead to freedom from microbiological contamination. Without effective filtration taking place in the soil above and through the aquifer, contaminants may still reach the bore; deep groundwaters in volcanic areas such as Auckland and karst limestone aquifers are examples.

WQRA (2011) gives an example:

A large norovirus outbreak occurred at a newly opened restaurant in Wisconsin, US. The premises had a private bore located in a fractured dolomite rock aquifer. The bore was 85.3 m deep and cased to 51.8 m. It was located 188 m from the septic leach field. Tracer tests using dyes injected into the septic system showed that effluent was travelling from both the septic tanks and infiltration field to the bore in 6 and 15 days, respectively. The private bore and septic system were newly constructed and had conformed to Wisconsin State Code.

Note that the DWSNZ do not define the procedure for demonstrating whether an aquifer is confined. Section 4.5.2.1 of the DWSNZ includes three techniques for demonstrating that the bore water is not directly affected by surface or climatic influences. In effect, this means much the same thing, but see next paragraph. The water supplier must provide sufficient information for an experienced groundwater engineer/hydrogeologist/scientist to be able to make that decision. The sort of data required will include any information already known about the aquifer, geological information gathered during the drilling (bore log), the depth to the screen, full details about the screen and casing, results of pump tests (piezometric survey), etc. Demonstration 3 offers a technique for situations when demonstration 1 and 2 are not feasible. In the absence of some of the above, existing bores may need plumbing (depth sounding), or a CCTV inspection. Ideally, water suppliers should also have information about the recharge area and relevant land uses.

Despite drawing from a confined aquifer, it may still be possible for the water to fail to satisfy the requirements of bore water security criterion 1. This may be because the:

- bore is too close to the recharge area
- confining layer is not extensive enough (wide or deep or intact) to be effective
- main aquifer can receive water from a subsidiary aquifer or other source that is not confined or contains 'young' water.

Also, the person stating that the bore is drawing from a confined aquifer may have been wrong, or that conditions have subsequently changed.

To be secure, bore water must meet all three criteria. These show that:

- a) activities on the surface or climatic events have no direct influence on the quality of the groundwater (bore water security criterion 1)
- b) the bore head provides satisfactory sanitary protection for the bore (bore water security criterion 2)
- c) *E. coli* are absent from the water (bore water security criterion 3).

Once security has been demonstrated, the on-going *E. coli* monitoring requirements are reduced substantially, as shown by Table 4.5 in the DWSNZ. Bore water security criteria 1 and 2 need to be checked at least every five years.

The secure status of a bore water supply indicates that microbiological (both bacterial and protozoal) contamination of the water is unlikely. However, it provides no indication of the chemical quality of the water. Groundwaters isolated from surface events become better protected microbiologically as the time since the water entered the ground increases, because of processes such as dilution, filtration, adsorption and die-off. Some chemical determinands may be unaffected by processes that improve the microbiological quality of the water. Processes, such as the dissolution of minerals containing arsenic, will make the chemical quality worse with extended residence times. Consequently, the time the water is under the ground may bear no relationship to the chemical quality of the water.

### 3.2.4.1 Proving the microbiological quality of the water

*E. coli* is the micro-organism used to indicate the bacterial quality of bore water drawn from a groundwater source. Although the presence of *E. coli* in the water shows that faecal contamination of the water is very likely to have occurred recently, there is no reliable relationship between the concentrations of *E. coli* and protozoa in the water. Assurance about the protozoal quality of the water is obtained by demonstrating that the water quality is not directly influenced by events above ground, see section 3.2.4.2.

A bore water that has achieved secure status must continue to be monitored for *E. coli* at the point where it enters the distribution system, at the frequency stated in Table 4.5 and note 5 (DWSNZ). Samples must be taken prior to any treatment, and *E. coli* must be <1 per 100 mL in any sample (bore water security criterion 3). Note that once the bore water is in the distribution system, it (like drinking water from surface sources) must comply with section 4.4 of the DWSNZ.

The provision of an interim secure status allows a reduced *E. coli* monitoring frequency during the proving period and avoids situations in which a water supply, to comply with the DWSNZ, has to install treatment (primarily for protozoal compliance) during the year in which data have to be gathered to demonstrate security.

The Massey University Protozoa Research Unit has been monitoring 4 non-secure bores for 6.5 years (September 2009–July 2016) for the Ministry of Health. To date 104 samples have been collected; although 11% of the samples have contained *E. coli*, none has contained *Cryptosporidium* or *Giardia* and only one has contained *Campylobacter*.

However, some bore waters are less likely to be able to achieve secure status so their monitoring needs to be more extensive. The following situations apply:

- a) **Unconfined aquifers < 10 m deep:** If the depth from the surface to the end of the casing/beginning of the screen is < 10 m, the bore water is considered to be equivalent to surface water (with respect to both bacterial and protozoal compliance).
- b) **Unconfined aquifers > 10 m deep:** It is possible for water in an unconfined aquifer > 10 m deep to satisfy bore water security criterion 1, in which case, it can also be given 'interim secure status'. But if bore water security criterion 1 is not, or cannot, be met – refer to (d ii).
- c) **Water from confined aquifers:** There is no minimum depth requirement if drawing from a confined aquifer. But in reality, it is difficult to imagine an aquifer that lies < 10 m below the surface being able to satisfy the requirements of being 'confined'. And unless the confining layer is extensive, it is difficult to imagine it consistently satisfying "water younger than one year not being detectable ... etc". But if the bore water is drawn from a confined aquifer, and satisfies bore water security criterion 1, then it can be given 'interim secure status' and be monitored for *E. coli* in order to prove bore water security criterion 3.

If the bore water is drawn from a confined aquifer, but does not or cannot satisfy bore water security criterion 1 – refer to (d ii).

To gain 'secure status' also requires bore water security criterion 2 to be satisfied, and a water supplier would be unwise to start *E. coli* monitoring before securing the bore head. The *E. coli* monitoring requirements are defined in Table 4.5 of the DWSNZ. Bores with 'interim secure status' serving > 10,000 people (for example) require daily testing for three months, and if no *E. coli* is found, monthly testing for the next nine months. If no *E. coli* is found during that 12-month period, bore water security criterion 3 has been satisfied. If Bore water security criteria 1 and 2 are satisfied, the bore water can be called secure, and for the next 12 months, *E. coli* monitoring remains monthly. If still free from *E. coli* after 12 months, monitoring can be reduced to quarterly. Bore waters given 'interim secure status' and 'secure status' are assumed to satisfy protozoal compliance.

- d) **Unconfined aquifers > 10 m deep, not complying with (or not tested for) bore water security criterion 1:** There are two situations:
  - i) 10–30 m deep: If the depth from the surface to the end of the casing/beginning of the screen is between 10–30 m the bore water is to be monitored for (and be free from) *E. coli* for five years before its secure status can be considered. During this time it is considered equivalent to surface water for the purpose of both bacterial and protozoal compliance. Regarding *E. coli* monitoring, these bore waters will require weekly, twice weekly or daily testing (depending on the population served) for the first three months, and if no *E. coli* is found, monthly testing for the next four years nine months. If no *E. coli* is found during that five-year period, bore water security criterion 3 has been satisfied. If bore water security criterion 2 is still satisfied, the bore water can be called secure, and monthly *E. coli* testing continues for the next 12 months; if still free from *E. coli*, monitoring can be reduced to quarterly.



For at least five years, water from these bores will need to be disinfected. Section 5.2.1.1 and Table 5.1a of the DWSNZ explain that these bores will require three protozoal log credits.

As an example, applying UV disinfection at 40 mJ/cm<sup>2</sup> with a validated unit should be able to achieve bacterial compliance (section 4.3.5) and protozoal compliance (section 5.16, up to 3 logs). If these bore waters are given secure status they will be assumed to satisfy protozoal compliance; that means the UV disinfection system can be turned off.

- ii) >30 m deep: If the depth from the surface to the end of the casing/beginning of the screen is >30 m, and the water from the bore does not comply with bore water security criterion 1, it “must be drawn from a source for which hydrogeological evidence indicates that the bore water is likely to be secure” for bore water security criterion 1 to be satisfied, ie, to be granted interim secure status. Those words were used to cover the situation where the bore log information has been lost (for example), or the age results (demonstration 1) are marginal or confusing, or the chemical composition does not quite meet the requirements of demonstration 2. ‘Hydrogeological evidence’ is not to be confused with ‘hydrogeological model’ which is discussed in demonstration 3 of bore water security criterion 1.

Bores drawing >10 m deep from a confined aquifer, but which do not or cannot satisfy bore water security criterion 1 may be granted interim security by following the procedure in the preceding paragraph.

The hydrogeological evidence referred to above must be provided by suitably experienced, qualified and independent personnel, and must cover all pertinent aspects related to the aquifer and the bore (and any nearby bores drawing from the same aquifer), particularly seasonal effects, piezometric levels and pump tests.

What is hydrogeological evidence? Section 4.5.2.3 of the DWSNZ allows bores >30 m deep drawing from unconfined aquifers to produce evidence (hydrogeological) that the bore water is likely to be secure (ie, not directly affected by surface influences). Bores drawn from an unconfined aquifer could still undergo the age test or the chemical consistency test, ie, section 4.5.2.1. If the bore water satisfies those criteria, that will be good quality supporting evidence. If it ‘just misses’ to satisfy those criteria, that could be helpful supporting evidence. If it ‘misses by miles’ the information may suggest not to bother looking for any further hydrogeological evidence.

If the bore is in limestone (karst) or basalt country there is a risk that surface water will reach considerable depths in quite short time. Likewise for parts of the country like Canterbury where beneath the topsoil there are predominantly gravel, big river stones and boulders. Most old groundwater has lost its dissolved oxygen, so conversely, a bore water with quite a lot of dissolved oxygen (say >4 mg/L) is probably ‘young’, regardless of the depth or whether from a confined aquifer. Very old water should never have *E. coli*, and the total (heterotrophic) plate count is invariably <5 per mL. Bores with no *E. coli*, but with total coliforms, or with TPCs >100 per mL, probably don’t come from an aquifer where the bore is likely to be secure. Likewise, the temperature of a deep secure bore water will hardly change during the year when in use, maybe no more than 0.2°C, ie, often less than the ability of a technician to measure it. Bore water

likely to be 'directly affected by surface influences' will probably show a distinct and reproducible seasonal pattern of temperature. Water suppliers might say the DWSNZ (or DWAs) don't ask for these tests. But the DWSNZ are minimum requirements – water suppliers should want to know about the quality of their water. It is highly likely that a water supplier has tested the bore for *E. coli* for some time before approaching a DWA; that information will be an important part of their 'hydrogeological evidence' so they should provide it, all of it.

If the hydrogeological evidence does not exist, or does not indicate that the bore is likely to be secure, then the procedure in (i) may be followed, as above. That is, the water will be considered equivalent to surface water and some form of treatment will be required to gain protozoal compliance, for at least five years. Being deeper than 30 m means 2 log credits will be required (DWSNZ Table 5.1a).

It is unlikely that a bore will be granted interim secure status if it draws from an unconfined aquifer, especially if less than 30 m deep. A lot would need to be known about the recharge area and land-use practices will need to be watched diligently.

Section 3.2.4.6 discusses the procedures to be followed if *E. coli* is found.

The interim status lasts for 12 months only, subject to section 3.2.4.6. Sampling over a period of at least a year has the advantage of establishing whether there are any seasonal or climatic trends that would indicate surface influences. During this time, the water supplier must gather data to demonstrate security in full, ie, as well as the criteria met for interim status, the groundwater has to be shown not to be directly influenced by events above ground. If the full set of criteria for showing security cannot be met after the 12-month interim period, the source reverts to a non-secure status, and appropriate treatment processes must be in place and operating satisfactorily for the supply to be able to comply with the DWSNZ.

All *E. coli* samples must be taken upstream of any treatment that is likely to disinfect the supply. The purpose of these tests is to characterise the quality of the raw water, not determine the quality that can be produced after treatment. Conversely, if a secure bore water supply receives any form of treatment or onsite storage that is potentially able to result in microbiological contamination of the water before entering the distribution system, it will need to achieve bacterial compliance as for surface waters, eg, section 4.3 of the DWSNZ.

See Chapter 8: Protozoal Compliance, section 8.2.2 for a discussion on the procedure for determining the protozoal log credit requirement for bore waters.

### 3.2.4.2 Demonstrating groundwater residence time

Water significantly influenced by surface or climatic conditions is most likely to be water that has only been underground for a short time, or from an aquifer containing a fraction of 'younger' water. The opportunity for the levels of disease-causing micro-organisms to be reduced by die-off, dilution, or filtration as the water moves through the ground is much less in new than old groundwaters. Being able to show that there are no signs of above-ground influences therefore provides additional confidence that the acceptable microbiological (including protozoal and viral) quality of the water already shown by the *E. coli* testing will continue.

Bore water security criterion 1 provides two options by which the absence of above-ground influences can be demonstrated:

- a) showing directly that the water is not new by isotopic (tritium) and chlorofluorocarbon (CFC) and sulphur hexafluoride (SF<sub>6</sub>) measurements
- b) showing indirectly that the water is unlikely to be new by the low variability of its physicochemical characteristics.

A third option, based on hydrogeological modelling, is only available in the event that difficulties arise with the first two options. These difficulties are discussed below.

#### Determination of the residence time

The mean residence time of groundwater is the average time the water has been underground, from the time it leaves the surface to when it arrives at the point of abstraction. During this time the concentrations of microbiological contaminants will be minimised due to mechanisms including filtration, dispersion and die-off. The DWSNZ require the estimation of the residence time to be made by measurements of tritium and CFC (chlorofluorocarbon) and SF<sub>6</sub> (sulphur hexafluoride) concentrations in the water.

Age dating of water yields an average age of the water. Although this is helpful, most groundwaters are mixtures of water with different ages because of the nature of flow in porous materials. What one really wants to know is: what is the fraction of the water with age less than one year? The DWSNZ specify that this fraction must be less than 0.005 percent of the water present in the aquifer. This young fraction can be determined from a series of samplings for tritium, CFCs and SF<sub>6</sub>, separated in time by several years. Single samplings of tritium, CFCs and SF<sub>6</sub> can sometimes be used for less precise estimates of the young fraction, but must be confirmed by future sampling.

Note that a bore water that satisfies the age test may still contain contaminated water if the confining layer is ruptured, or when a nearby bore has a faulty bore head thereby offering a pathway to the aquifer, or from complications caused by earthquakes and flooding, or land-use changes, or increased use of the aquifer.

Tritium is a radioactive isotope of hydrogen, which decays with a half-life of 12.4 years (the time it takes for the number of tritium atoms present in a sample to decrease by 50 percent). It is an ideal tracer for groundwater because it is a component of the water molecule, and the information it provides is unaffected by chemical and microbial processes, or reactions between the groundwater and soil, sediment or aquifer material.

Cosmic rays passing through the atmosphere generate natural background levels of tritium, but during the 1950s and early 1960s large amounts were produced in the atmosphere by thermonuclear tests, see Figure 3.1. Tritium is distributed between the atmosphere and bodies of water such as lakes, rivers and most importantly the oceans, but its concentration changes with time and location. Concentrations of tritium in rainfall reflect the local tropospheric tritium concentrations, and allow the input of tritium into land-based hydrological systems to be assessed. Once rainwater infiltrates into the ground, it is separated from the atmospheric tritium cycle, and its tritium concentration, which is no longer affected by exchange with the atmosphere, decreases by radioactive decay. The tritium concentration in the groundwater therefore depends on the time it has been underground.

CFCs are a family of entirely man-made contaminants of the atmosphere and hydrological systems. They are used industrially for refrigeration, air conditioning and pressurising aerosol cans, and once released become widely distributed in the atmosphere because of their high chemical stability in this environment. Their use is being increasingly regulated.

Before 1940 CFCs were not present in the atmosphere, but since then their concentration has increased with their increased use, see Figure 3.1. They are slightly soluble in water and are therefore present in recharge waters at a concentration that depends on the temperature of the water and the atmospheric CFC concentration at the time of recharge. Measurement of the CFC concentration in a groundwater therefore allows the time at which the water entered the ground to be determined.

CFCs have given reliable age results for waters in the majority of groundwaters analysed in New Zealand. There are, however, potential sources of error with the measurements. CFC-11 (one member of the CFC family) is more susceptible to degradation than CFC-12 in underground environments that are oxygen-deficient; the water may therefore be calculated to be older than it really is. CFC-12 measurements, on the other hand, are more susceptible than CFC-11 measurements to interference from local sources of contamination. This may make the water appear younger than it is.

The properties of SF<sub>6</sub> make it useful in a number of industries (eg, electrical and electronics industries, magnesium manufacturing, refrigeration, air-conditioning, foam production). Because of its chemical stability it has a lifetime in the atmosphere of the order of 3200 years. Atmospheric concentrations before 1970 were zero, but its concentration has increased at approximately 8 percent per annum since then. It is slightly soluble in water and provides another marker for establishing residence time. Its potency as a greenhouse gas is causing its use to decrease and its atmospheric concentration will eventually decrease. Natural occurrences of SF<sub>6</sub> have been noted in some deeper aquifers in volcanic areas (Van der Raaij 2003).

**Figure 3.1: Atmospheric CFC and tritium concentrations in rain water**

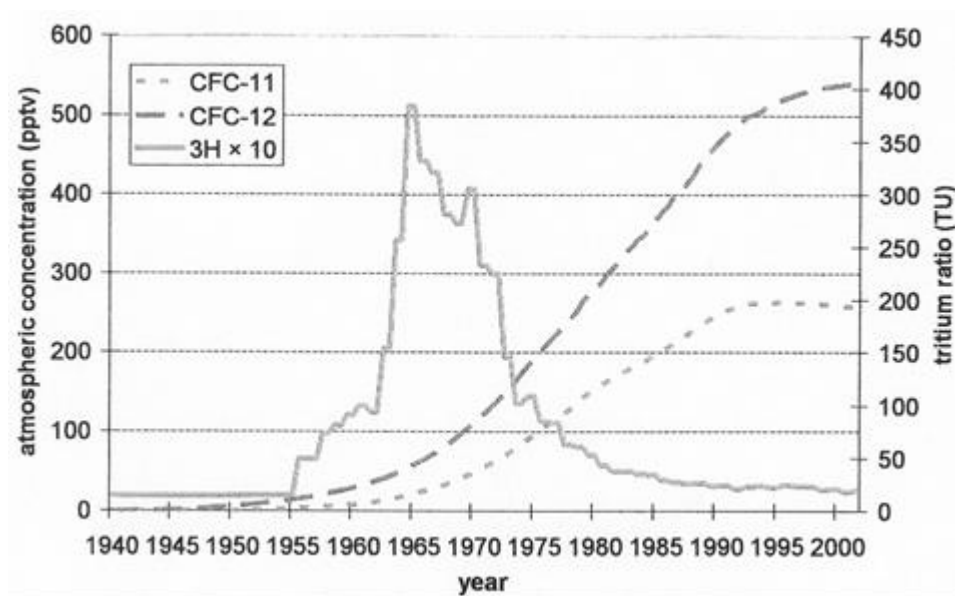

### Detection of new water

A sample of groundwater does not have a discrete age. Mixing processes underground ensure that any sample of water consists of a mix of waters of various ages. Different mathematical models have been developed to account for the distribution of water ages that may arise in a particular situation. Factors such as the nature of the aquifer (confined or unconfined) and the way in which the aquifer is recharged (rainfall or river) influence the form of the model.

The DWSNZ require that the new water fraction (water less than one year old) is less than 0.005 percent, based on a number of assumptions. This criterion has been set as a realistic lower limit for age determinations once accepting likely uncertainty in model fitting parameters and detection limits. Contact GNS to arrange for sampling, which has specific requirements, eg, Daughney et al (2006).

Sources with <0.005 percent of groundwater less than one year old are considered unlikely to be contaminated by disease-causing micro-organisms primarily because of die-off and filtration processes, as well as a high dilution rate. This is supported by monitoring data to date from groundwater supplies in New Zealand. Contamination from 'young' groundwater entering an aquifer via leakage through preferential pathways is not accounted for in dating analysis; this makes sanitary bore head protection a very important tool.

The mathematical models used to estimate residence time distribution require two parameters to describe realistic groundwater situations: the mean residence time and the dispersion parameter. The dispersion parameter reflects the degree of mixing and is a measure of the spread of the times different components of the water have been under the ground.

Adjustment of these two parameters to give the best match to the measurements allows the distribution of residence times to be determined. The presence of new water can be estimated from this. Where the analytical results are clear or the hydrogeological situation well-understood, a single dating exercise may be sufficient to allow the mean residence time and the fraction of new water present to be determined.

### Age calculation

Measured CFC concentrations in groundwater are corrected for excess air and used to calculate corresponding atmospheric concentrations using Henry's Law and an estimated recharge temperature. The excess air correction and recharge temperature are calculated from the ratio of dissolved nitrogen and argon concentrations, which are measured simultaneously with the CFC concentrations (Heaton and Vogel 1981). The calculated atmospheric concentrations are then used to calculate the CFC model age of the groundwater (Plummer and Busenberg 2000).

To calculate the mean recharge ages and young fraction, GNS uses an exponential piston flow model (Zuber 1986). A conservative estimate of the mixing fraction of 90 percent has been used. This approximates a mainly exponential mixing situation as may occur in an unconfined aquifer. For a confined aquifer, the mixing fraction is likely to be somewhat lower than this estimate. However, in this case, the use of the higher mixing fraction does not affect the calculated young fraction. The mixing fraction estimate may be further refined by additional measurements in two years' time **OR** the ages have been calculated using a mixing fraction of 70 percent in the aquifer (E(70 percent)PM). The error shown represents the uncertainty in estimating the mixing fraction within the aquifer, and is estimated at  $\pm 10$  percent. That is, the upper and lower limits of the error on the mean recharge age are given by E(80 percent)PM and E(60 percent)PM respectively.

### Variability in physicochemical determinands

Water that has been in the ground only a short time is likely to be more variable in quality than older water. The processes of mixing and dispersion that occur as the water and dissolved constituents travel through the groundwater system mean that any variability in the quality of water that has recently entered the ground will tend to decrease with time and distance travelled. Deeper waters therefore tend to be older and less variable in quality than shallower waters, because of the time taken to travel to greater depths. Waters contained in confined aquifers (those overlain by confining layers (aquitards)) also tend to be older than shallow water in unconfined aquifers. In this case, the water has to travel along the aquifer from the recharge zone, which generally takes longer than permeating vertically into a shallow unconfined aquifer.

Variability in the composition of groundwaters may arise for any of six reasons (other than variations caused by a faulty bore or bore head):

- 1 **Seasonal recharge:** During winter and spring, high rainfall combined with lower evaporation rates and lower plant productivity causes greater leaching of chemicals, such as nitrate, stored in the soil. More new water enters the aquifer from the surface at this time and may therefore show higher concentrations of these chemicals. The dissolved oxygen content will increase too, and probably turbidity.

- 2 **River recharge:** High river levels during winter and spring may increase the amount of new water feeding into aquifers. Flood events may also increase the recharge with new water, but this may not be related to season. Long dry periods may allow fine silt to fill the pores between stones on the river bed thereby restricting recharge.
- 3 **Intermittent discharge events:** Activities that contribute to variability in water quality in this category include septic tanks leaking or overflowing during high rainfall, fertilising of pastures, land application of sewage, or chemical spills. Where bore heads are non-secure, floods may also cause spikes of contamination as the result of floodwaters running down the bore casing.
- 4 **Groundwater abstraction:** Changes in pumping regime in the supply bore or neighbouring bores or new bores can cause changes in groundwater flow directions or leakage rates. As a result, seawater (if near the coast), and water from nearby rivers, or overlying or underlying aquifers may be drawn into the vicinity of the supply bore.
- 5 **Changes in climate and land use:** Gradual, long-term changes in water quality may arise from changes in climate and land use. Although they may not affect the security of the bore water, because changes may be slow enough to allow removal of micro-organisms, they may have important implications for the future water quality and quantity from the aquifer.
- 6 **Earthquakes:** Earthquakes can disrupt the confining layers, rupture bores and alter flow paths, see section 3.2.3.1.

Table 3.2 summarises statistics for the conductivity, chloride and nitrate concentration data used to establish the variability criteria contained in Bore water security criterion 1, demonstration 2 (section 4.5.2.1 of the DWSNZ). The criteria are maximum allowable values, and are designed to be conservative. All three determinands must be used. Some supplies not meeting the criteria for secure status on the basis of chemical variation may still be found to be secure using the age determination techniques.

**Table 3.2: Statistics showing the variability in conductivity, chloride and nitrate-N for groundwaters**

| Determinand     | Statistic                 | %   |
|-----------------|---------------------------|-----|
| Conductivity    | Co-efficient of variation | 3.0 |
| Chloride        | Co-efficient of variation | 4.0 |
| Nitrate-N, mg/L | Standardised variance     | 2.5 |

The co-efficient of variation and standardised variance in Table 3.2 are defined as follows:

$$\text{Co-efficient of variation (standard deviation/mean): } \sqrt{\frac{n \sum x^2 - (\sum x)^2}{n(n-1)}} / \frac{\sum x}{n}$$

$$\text{Standardised variance (standard deviation}^2\text{/mean): } \frac{n \sum x^2 - (\sum x)^2}{n(n-1)} / \frac{\sum x}{n}$$

where x is a concentration of a determinand from the set of monitoring results.

Use of the coefficient of variation with data near the detection limit can create difficulties because the standard deviation is controlled more by uncertainty in the measurements than true variability in the determinand. This situation often arises with nitrate measurement. To minimise this effect of measurement uncertainty in nitrate measurements, the standardised variance is used as the statistic for nitrate measurements. The value of the standardised variance, however, is dependent on the units in which it is expressed, and nitrate concentrations must therefore be expressed as NO<sub>3</sub>-N in mg /L when making this calculation for assessing security.

### Example

Table 3.3 lists two sets of results from measurement of nitrate in samples from two separate bores. The statistics calculated from these are tabulated at the bottom.

The first step in deriving the required statistics is to calculate the mean and the standard deviation for each data set. These functions are available on scientific calculators and in spreadsheets such as Excel®. Although the coefficient of variation is not the required statistic for nitrate, it is included here to show how it is obtained, and for comparison discussed below. The coefficient of variation is calculated by dividing the standard deviation by the mean. The DWSNZ require the statistics to be expressed as percentages, therefore it is multiplied by 100 to give values of 18 percent and 50 percent, for bores 1 and 2 respectively.

**Table 3.3: Example of calculations of coefficient of variation and standardised variance**

| Sample number              | Nitrate, mg/L as NO <sub>3</sub> -N |        |
|----------------------------|-------------------------------------|--------|
|                            | Bore 1                              | Bore 2 |
| 1                          | 0.24                                | 1.6    |
| 2                          | 0.21                                | 3.8    |
| 3                          | 0.15                                | 2.1    |
| 4                          | 0.15                                | 1.7    |
| 5                          | 0.21                                | 3.1    |
| 6                          | 0.15                                | 1.0    |
| 7                          | 0.22                                | 0.9    |
| 8                          | 0.21                                | 1.6    |
| 9                          | 0.15                                | 2.3    |
| 10                         | 0.18                                | 1.1    |
| 11                         | 0.21                                | 3.2    |
| 12                         | 0.15                                | 4.2    |
| Statistic                  |                                     |        |
| Mean                       | 0.186                               | 2.217  |
| Standard deviation         | 0.034                               | 1.116  |
| Coefficient of variation   | 0.184                               | 0.503  |
| % Coefficient of variation | 18%                                 | 50%    |
| Standardised variance      | 0.006                               | 0.562  |
| % Standardised variance    | 1%                                  | 56%    |



The statistic to use for checking on the acceptable level of variability in nitrate is the standardised variance. This is calculated by squaring the standard deviation, and dividing the result by the mean. Again, it is expressed as a percentage by multiplying by 100. This yields results of 1 percent and 56 percent for bores 1 and 2 respectively.

For the variation in the nitrate concentration to be considered acceptable, the standardised variance expressed as a percentage must be less than 2.5 percent. Bore 1 therefore meets this criterion, but bore 2 does not. Comparison of the coefficients of variation with the standardised variance shows a relatively small difference between these two statistics for bore 2 where the nitrate concentrations are well above the limit of detection (ca 0.05 mg/L as NO<sub>3</sub>-N). However, in bore 1, where the nitrate concentrations are less than 0.5 mg/L NO<sub>3</sub>-N and closer to the limit of detection of the method, there is a very large difference between the two statistics.

Some secure bore waters can show almost identical chemical composition year after year, so using chemical consistency can be an effective tool to demonstrate security. This applies in about one third of bores; residence time should otherwise be used. As an example of the complexity when using this approach, many of the groundwaters under Christchurch are considered to be secure, but their chemical composition can vary, depending on the relative proportions of water originating from rainfall or from the Waimakariri River. In situations where there may be difficulties in assessing variability in any of the three determinands at low concentrations, the water supplier should consult with the DWA, who may allow the result to be disregarded for the determinand of concern. Supporting data that show clearly the reason for high variability will have to be provided to the DWA for these data sets to be disregarded.

These samples must be collected with care. Ensure that the water in the sample bottle represents the aquifer, not stale water that has been sitting in the pipe for some time. Sample the bore head, before any treatment, and not from a tank or the distribution system. Refer also to Sundaram et al (2009).

A very competent laboratory is needed when using the chemical consistency technique. For example, as an indication of the likely variation that could be encountered (using somewhat generalised uncertainties!):

- a good laboratory technician measuring chloride in 12 replicate samples (ie, in one batch) should obtain a result in the order of (say) 15 ±1 mg/L
- the same person should achieve something in the order of 15 ±2 mg/L testing these samples in 12 separate batches (see Chapter 17, section 17.5.5)
- but if different technicians did the test each time, the results could be 15 ±3 mg/L
- if different laboratories were hired, the results may be something like 15 ±4 mg/L
- and if these laboratories used different methods of analysis, results could even be 15 ±5 mg/L.

If bore water security criterion 1 has been demonstrated on the basis of the variability of chemical determinands, these determinands must thereafter be measured annually to check that they continue to lie within the range found originally. In the event that they do not, the appropriate statistical parameter should be recalculated with the inclusion of the new data to determine whether the compliance criterion is still met. If the appropriate compliance criterion is not met, the DWA should be consulted, and the

cause for the increase in the variability parameter considered. For example, the increase may result from a long-term trend of a change in the determinand concentration. This is not an indication that the groundwater quality is responding directly to events above ground. In this case, it may be appropriate to recalculate the variability parameter using the 12 data collected most recently. Where no significant trend is evident, the increase in the variability parameter may require a reassessment of the secure status of the supply.

### Approach for demonstrating that a water is not directly affected by surface or climate influences

The following is suggested as an approach for establishing whether a groundwater is directly affected by surface or climate influences.

#### Approach 1: Chemical consistency

- Check whether enough chloride, conductivity or nitrate data are available to determine the variability of all of these determinands, carry out further sampling if necessary, and calculate the statistics.
- To calculate the statistical parameters for any one of these determinands, at least 12 data points are needed. They may be collected monthly over one year, bimonthly over two years or quarterly over three years.
- When collecting samples it is important to ensure that the bore is fully purged of stagnant water by pumping out at least three bore-volumes before the samples are taken.
- Once the data sets are obtained, calculate the appropriate statistical parameters (see Table 3.2 and the related *Example* above). The lack of surface or climate influences is demonstrated if the requirements of section 4.5.2.1 of the DWSNZ are met.
- All determinands must meet the criteria for chemical determinand variability if the source is to be regarded as secure. If this requirement cannot be met, the absence of the influence of surface effects must be shown another way (see Approach 2). As discussed in the section on chemical determinand variability, if a dataset for one determinand cannot meet the requirements of section 4.5.2.1 of the DWSNZ, the results for this determinand may only be disregarded following approval by the DWA.

#### Approach 2: Determine the residence time by tritium and CFC and SF<sub>6</sub> analysis

- Samples for these measurements should ideally be taken between winter and spring when groundwater systems are most likely to be recharged with new water. Local personnel can collect samples for tritium measurements, but CFC or SF<sub>6</sub> sample collection must be managed carefully due to potential air entrainment. Although some correction can be made for additional air, Institute of Geological and Nuclear Sciences (GNS) staff may be required to take the samples. GNS should be contacted for analytical charges and charges for sampling personnel. The USGS Reston Chlorofluorocarbon laboratory website (<http://water.usgs.gov/lab/>) has a lot of further information.

- Water suppliers should ensure that information provided to the MoH contains the following information:
  - a full description of the procedure used to determine the residence time, which includes the mixing model assumptions, the justification for these assumptions and an interpretation of the data
  - the percentage of water that has been under the ground for less than one year (rather than an average residence time).
- Further confirmational dating must be carried out if the analyst specifies it to be necessary.
  - It is possible that a single measurement is insufficient to determine reliably the percentage of new water in a groundwater. For this reason more than one analysis is recommended. Subsequent residence time determination, eg, after two years, is likely to provide greater confidence, particularly for tritium analysis.

### Approach 3: Hydrogeological modelling

- Should residence time determination not be considered feasible due to the presence of non-meteoric tracers, and Bore water security criterion 1 cannot be demonstrated by chemical variability criteria, then a hydrogeological model can be used to establish the security of the aquifer.
- For this approach, the water supplier is likely to require the services of a groundwater consultant who can contract to undertake modelling that meets the requirements stated in section 4.5.2.1 of the DWSNZ. The completed modelling must show that contamination by pathogens is very unlikely, to the satisfaction of a person (or persons) deemed (by the Ministry of Health) to be qualified for reviewing the modelling work.
- The results from hydrogeological models are calculated flowpaths and concentrations of determinands, microbiological or chemical, in the groundwater at a particular location and depth. The accuracies of the outputs from the model depend on:
  - The appropriate choice of model: A range of models exists, not all of which may be suitable for a given situation. For example, distinctions need to be made between models designed to deal with point source contamination, and those intended for non-point source contamination arising over an area. The number of dimensions that the model takes into account also needs to be considered. Where preferential flow paths exist, these should be accounted for in the model. Knowledge of the geology of the area being modelled is needed to assess whether such flow paths are likely.
  - The accuracy of the input parameters: Values for input parameters must be provided for the model; the number of input parameters will depend on the model's complexity. Some parameters, such as reaction rates and microbial die-off rates may be universal, but others, such as adsorption coefficients and hydraulic conductivity, will depend on the soils, or aquifer media in the area being modelled. This latter type of parameter must be given either a value obtained from laboratory or field measurements, or a conservative value, ie, a value that is more likely to lead to the model producing a non-secure conclusion if the selected value is inaccurate.

- The modeller needs to be able to justify the selection of all input parameters, as the modelling will have to be verified as being acceptable by a person deemed qualified by the Ministry of Health. It is suggested that proposed models be discussed at the conceptual stage with persons advised by the MoH to ensure applicability.
- Comparison of the predicted concentrations of microbial contaminants in the aquifer at the point of abstraction, with the levels of contaminants permitted for a secure bore water (less than 1 *E. coli* per 100 mL), will indicate whether the source is predicted to be considered secure.
- The model must be run under different scenarios designed to take account of all likely circumstances that would challenge compliance with Bore water security criterion 1. Models can be evaluated, see USGS (2004).
- Model auditing guidelines prepared by PDP (2002) for MfE will be used to provide guidance for model review. A conservative approach will be required given the uncertainties inherent in modelling.

USEPA (2008) discusses (in the appendices) several methods for assessing groundwater time of travel.

### 3.2.4.3 Establishing adequate bore head protection

See Chapter 18 of WHO (2006) for a full commentary on bore head protection (or sanitary completion as they call it).

A geological log and bore construction details should be available for all supplies being assessed for bore water security. Without this information the aquifer hydrogeologic setting and the suitability of bore design and construction cannot be assessed.

Proper bore construction including bore head protection is an essential requirement for establishing bore water security criterion 2 (DWSNZ section 4.5.2.2). It is also important for the protection of groundwater quality in the aquifer that the bore intercepts. As a minimum requirement, bore construction should comply with the Environmental Standard for drilling of soil and rock (NZS 4411, 2001), unless otherwise agreed by the MoH. Section 2.7 of NZS 4411 covers the decommissioning of bores. Another useful source of information is *Minimum Construction Requirements for Water Bores in Australia* (NUDLC 2012).

Good bore head protection is required for all bores used for drinking-water, not just those demonstrating security. Note that the Walkerton outbreak in Canada was caused by animal wastes entering the groundwater through the bore head. ANZECC (1995) discusses bore head protection plans. The AWWA (USA) has produced a thorough *Standard for Water Wells* (see ANSI/AWWA A100-06, 2006, see full list on <http://www.awwa.org/>).

## Siting and construction

Assessment of bore design and condition, as well as hydrogeologic setting, should be made by a person deemed suitably qualified and experienced by the Ministry of Health. Sanitary bore head protection should include an effective casing grout seal to prevent contamination from the ground surface. Where there is doubt about bore integrity there are a number of techniques, such as casing pressure tests and down-hole photography, which could be used but are likely to be beyond normal requirement. In general, above ground visual inspection and bore construction data would provide sufficient information. WHO (2006) notes that poorly mixed concrete used for linings and aprons may result in seepage of contaminated water into groundwater sources.

Sanitary inspections should be undertaken frequently, at least as often as water samples are collected. Risks are not static, they change over time as new development occurs in the area and are sometimes due to poor maintenance practices. Certain risks may also be important only seasonally, for instance the collection of surface water uphill of a groundwater source may only occur during wet periods. Therefore inspections may be required in both wet and dry seasons; WHO (2006). All bores have a limited life and therefore thorough periodic reviews are required. A five-yearly assessment of bore head conditions, with any changes reported by the supply manager, should provide appropriate assurance. It is important to develop a protocol for assessment.

The threat of aquifer contamination may be reduced both by proper bore construction (see Figure 3.2), and by locating bores away from sources of contamination so that the normal movement of groundwater carries contaminants away from the capture zone of the pumped bore. Minimisation of the possibility of contamination from potential local sources such as septic tanks and other waste disposal systems, fertiliser and pesticide stores, underground petrochemical tanks etc, will assist in reducing the threat of contamination. When water is pumped from a bore, the water level drops, causing a vacuum. Without an air vent, suction can develop, which could cause contaminated water to be drawn in.

Septic tanks and similar potential sources of faecal contamination that discharge faecal matter at shallow depths need to be sufficiently distant from the bore head that their discharge will not be captured by the bore. For example (USEPA 2000), 41 states have setback distances (the minimum distance between a source of contamination and a bore) that are less than or equal to 100 feet for sources of microbial contaminants. Five states appear to require setback from all sewage sources of more than 200 feet. Some require 50 feet from a septic tank and 10 feet from a sewer line. Some of the differences relate to the nature of the soil, the depth to the groundwater, and pumping rates.

ECan (2007) presented results of a groundwater modelling study to investigate whether the separation distances for waste discharges in rules in their proposed Natural Resources Regional Plan were adequate to mitigate the risks of virus contamination of water in domestic bores, and to provide a foundation for possible alternative separation distances. Earlier work (ECan 1999) had found that a separation distance of 50 m would achieve a 3 log reduction of *E. coli*. However, viruses can be infectious at much lower concentrations and travel much further in groundwater than

bacteria, and they are now considered to represent the highest health risk of contaminants in sewage discharges. A lot of ECan's proposal was based on New Zealand studies by Pang (2009).

Note that the USEPA (2006) Ground Water Rule recommends a 4-log concentration reduction between drinking water supply bores and contaminant sources. The current study found that much greater distances are required to reduce the number of viruses, see Table 3.4.

**Figure 3.2: Sanitary protection of a typical bore**

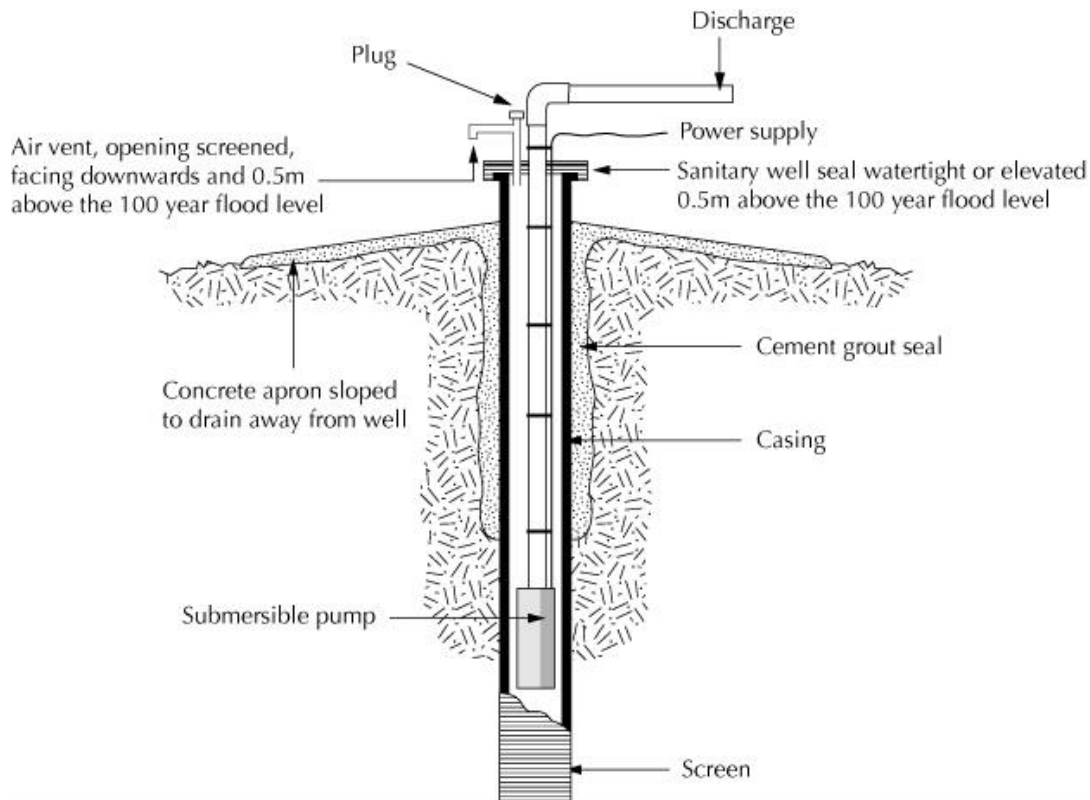

Factors that will influence the required set back distance will be:

- the discharge source characteristics (eg, size of the disposal system)
- the volume and concentration of micro-organisms in the discharge
- the nature of the soil in the infiltration zone
- whether there is a confining layer above the aquifer
- the direction of the groundwater flow with respect to the septic tank and bore head
- the conductivity of the aquifer material, which influences the groundwater velocity
- the depth to the aquifer
- the groundwater pumping regime.

**Table 3.4: Log reductions of viruses in Canterbury’s alluvial aquifers**

| Log reduction in concentration | Average separation distance (metres) | Standard deviation of separation distance (metres) |
|--------------------------------|--------------------------------------|--|
| 2                              | 25                                   | 27   |
| 3                              | 140                                  | 67   |
| 4                              | 389                                  | 125  |
| 5                              | 764                                  | 227  |
| 6                              | 1,186                                | 337  |
| 7                              | 1,594                                | 427  |

ESR (2010) developed the ECan study to National Guidelines. Section 7.1.1 includes:

Where regional plan rules require a separation distance from a bore, these generally require that the discharge from the on-site wastewater system must be separated from a domestic bore by between 20–50 m, depending on the particular regional plan. These separation distances have been imposed generally without substantive scientific basis or specific consideration of the sensitivity of groundwater to contamination at the location of the discharge. Where separation distances have been based on some scientific evidence of contaminant transport, they relate to bacteria.

The development of the Guidelines has shown that, in many instances, bacteria-based separation distances will be insufficient to protect drinking water quality from viruses discharged in domestic wastewater, and that the potential for viruses to be present in groundwater should be recognised in many more situations than is currently the case.

Their Guidelines develop separation distances for different hydrogeological settings and geology; these are summarised in their Table 8.2. Worksheets are included.

### Backflow prevention

The design and construction of a bore water supply should effectively prevent the ingress of contaminants from the ground surface by using a grout seal. Mixing of hydraulic or aquifer units of different water quality should also be prevented. The bore head should thereby minimise the possibility of contamination of the aquifer from the surface due to backsiphoning, by contaminants passing down the outside of the bore casing due to a poor seal between the casing and the ground, or through cracks in the bore head or casing.

The possibility of backflow of contaminated water from the treatment plant or distribution system down into the bore should also be guarded against by the use of a backflow prevention device. Backflow is defined as a flow that is contrary to the normal intended direction of flow. Increasingly, sludge and/or fertilisers are being applied to pasture by pumping them into the flow of water (which is often groundwater) being used for irrigation; this is a classic situation where contamination by backflow can occur.

One of the requirements in providing a satisfactory bore head is that an effective backflow prevention device is in place; see section 4.5.2.2 of the DWSNZ. The exact nature of the mechanism is not specified in the DWSNZ, as it was appreciated that different circumstances or local requirements may require different approaches to providing this protection. The NZWWA (2006) Code of Practice *Backflow Prevention for Drinking Water Suppliers* describes backflow prevention devices as including reduced pressure backflow devices, double check valves – testable and non-testable, dual check valves, vacuum breakers and air gap separation. The NZWWA Code of Practice has other requirements too, such as: *The water supplier shall ensure that those involved in the specifying, installation and monitoring of backflow devices are appropriately trained to carry out their work.* The NZWWA Code of Practice covers backflow technician qualifications and backflow device certifications. The MoH supports the CoP. The MoH also prepared (in 2001) a PHRMP Guide, D2.4: Backflow Prevention. NZWWA (2006) was revised in 2013. This includes:

The water supplier should ensure that all groundwater takes from an aquifer have adequate backflow protection. The backflow protection programme should require that bores are drilled, constructed and maintained in a manner that avoids any contamination of, or cross-connection with, groundwater aquifers. This should include ensuring that bore head construction on all bores incorporates a boundary device and, where required, a flow measuring device. Groundwater takes for irrigation or stock water with direct injection of chemicals should require, as a minimum, a double check backflow device to protect the aquifer.

Regional councils (see section 2.5.5.8 in NZS 4411, 2001): Environmental standard for drilling of soil and rock) require bores to include some form of backflow protection to prevent contamination of the groundwater system, so the regional council should be contacted first. Once they have explained their requirements, contact an experienced backflow prevention company because backflow prevention can be expensive, and it has to be installed so that the device can be tested, and without damage to the pump, etc.

A side-effect when using a backflow prevention device is the pressure loss it can create. This loss increases depending on whether a single-check valve, dual-check valve, double-check valve, or reduced-pressure backflow preventer is in use. Single-check valves and dual-check valves are not approved backflow prevention devices because they cannot be tested. Double-check valves are available as 'testable' and 'non-testable'. Some regional councils may permit the use of the non-testable double-check valves, particularly if it can be shown the bore will be used in a non-hazardous situation.

The installation of devices that offer greater levels of public health protection, but greater pressure losses, such as reduced-pressure backflow preventers, require regular testing and maintenance.

Single-check valves provide a lower degree of protection. Some regional councils may allow the risk associated with a possible loss of pressure to be reduced by installation of two single-check valves: one at the pump and the second a little downstream of the bore head.



## Animal control

Control measures are important to protect abstraction facilities against the potential for inundation by contaminated surface water or damage by animals or overland flows caused by heavy rainfall by diverting surface water away from the bore head. Diversion ditches should circle the bore head and drain the water away from the source.

Diversion ditches should be located some way from the bore head, but not so far that significant overland flow will be generated within the area between the ditch and the bore head. A general rule of thumb is a minimum of 6 m and preferably 10 m for boreholes and dug wells and up to 20 m for protected springs (WHO 2006).

Restricting access by both humans and animals to the bore head is also important to reduce risks of contamination and thus, where possible, water sources should be enclosed by a fence. The bore heads serving a piped distribution system should be located within a locked building which only the operation staff of the water supplier should have access to (WHO 2006).

The MoH PHRMP guide for abstraction from bores (PHRMP P1.3 – Groundwater Abstraction – bores and bores) recommends that the fence keep stock a minimum of 10 m from the bore head, and certainly no closer than the 5 m stipulated in section 4.5.2.2 of DWSNZ.

### 3.2.4.4 Multiple bores serving a drinking-water supply

Where a drinking-water supply is sourced from a number of bores, separate monitoring of each bore can lead to a large number of *E. coli* samples having to be taken. The DWSNZ (section 4.5.3) allow water suppliers to reduce the number of monitoring samples taken, if they can show that all bores are receiving water of the same quality, and that contamination of this water is very unlikely. If this is done, the bore considered to be the most vulnerable must be used to represent the bore field.

The water supplier must be able to show that:

- the bores (ie, screens) draw from the same aquifer under similar conditions
- any aquitard protecting the source is continuous across the bore field
- each bore head satisfies Bore water security criterion 2
- the chemical character of the water from each bore is similar
- monthly samples from the individual bores must contain <1 *E. coli* per 100 mL for three consecutive months.

These requirements are designed to give confidence that water quality information gathered from one bore in the field accurately reflects the quality of the water from other bores in the field. Information from several sources will probably be needed to provide this confidence. A number of these are discussed below. A preliminary step is to check that the depth the bore draws from is truly as reported.

## Stratigraphic data

Stratigraphic information can be obtained from bore logs. These reveal the nature of the various geological strata the bore passes through at that location and the thicknesses of these strata. The nature of the aquifer media in each stratum will allow the permeability of the layer to be evaluated and potential aquitards identified.

For a small bore field, identification of the same aquitard at each bore location will strongly support the assumption that it is continuous throughout the field. However, where the bore field is extensive, and there are substantial distances between locations for which stratigraphic data are available, the presence of the same aquitard in neighbouring bores does not guarantee that there are no breaks in the aquitard in the intervening area.

An indication that there are breaks in the aquitard may be gained from pump tests.

## Pump tests

Values for the transmissivity (the rate at which water is transmitted through a unit width of an aquifer under a unit hydraulic gradient) and the storage coefficient (the volume of water an aquifer releases from or takes into storage per unit surface areas of the aquifer per unit change in head) define the hydraulic characteristics of a water-bearing formation. Their evaluation at locations across a bore field will help in determining whether the aquifer drawn from at one bore is the same aquifer intercepted by other bores in the area.

Storage coefficient values will help to determine whether the pumped aquifer is confined or unconfined, as the coefficient values in confined aquifers are orders of magnitude smaller than those of unconfined systems, cf  $10^{-5}$ – $10^{-3}$  (confined) and 0.01–0.3 (unconfined); the units are dimensionless.

These values can be evaluated by a number of means, but the most reliable is to undertake a pump test at the bore field. Constant-rate and step-drawdown tests are the two most useful forms of pump test. Both require observation bores to be sunk at distances out from the production bore. The reader is referred to texts (eg, Driscoll 1986; Dominco and Schwartz 1998) for more detailed information on the subject of pump tests.

Interpretation of time-drawdown plots, obtained by measuring the levels of drawdown in production and observation bores with time after a pump tests starts, can provide information about additional aquifer characteristics such as potential recharge from nearby rivers or springs and leakage through confining layer/s. Depending on the location of abstraction bores, pump tests may also indicate intersecting hydraulic effects of drawing water from multiple bores.

## Water chemistry measurements

Microbiological water quality data are of little value in helping to assess whether a number of bores are all drawing from the same aquifer, especially if the water is of generally good microbiological quality and the levels of indicator organisms are below the limit of detection. However, most key chemical constituents of a bore water will be present at detectable concentrations. Comparison of the chemical characteristics and determinand ratios would indicate similarity.

Several different ways of displaying water quality data can be used, eg, tabulation of the data; bar graph; pie chart; Piper diagram; Stiff diagram. The most useful diagrams are probably those developed by Piper (1944) and by Stiff (1951), both of which require the concentrations of the constituents, which are usually expressed in mass per volume, to be expressed in equivalents per litre. Piper diagrams are trilinear and more complicated to interpret, but Stiff diagrams produce a simple pictorial representation of the water quality. Comparison of the shapes of the polygons that result from this form of analysis allow waters from similar hydrogeologic environments to be traced over large areas. The use of cluster analysis and/or principle component analysis may also be useful in illustrating similarities or differences in groundwater chemistry (Wilkinson et al 1992).

Waters that are chemically the same may be from the same aquifer, but marked differences in water chemistry show that either the aquifer is different or the aquifer is being influenced by input from another water-bearing formation.

## Hydrogeological modelling

Modelling of the aquifer system by groundwater consultants may be undertaken to support rationalisation of monitoring. Modelling is most applicable where the bore field is extensive. See section 3.2.4.2, Approach 3, for some discussion on hydrogeological modelling.

### 3.2.4.5 Changes in security

The classification of a bore water as secure is not necessarily a permanent status. This is reflected in the on-going checks required within each of the three bore water security criteria specified in the DWSNZ. Signs that a supply may lose its secure status include:

- extreme events, such as floods or droughts, which may affect groundwater quality
- the aquifer structure being altered by a geological event, such as an earthquake
- a breach in the aquitard from developments in the confined area of an aquifer
- a major change in land use
- a large new bore affecting flow patterns or water levels
- corrosion of the bore casing, damage or deterioration of the bore head leading to surface water, or water from a poor-quality aquifer, entering the bore.

Some groundwater supplies may be a mixture of waters from different depths. Droughts, floods, or periods of excessive drawoff may affect the relative contributions from these sources.

When the water supplier is aware of an event that may affect the secure status of the bore water, action should be taken, where possible, to minimise the impact of that event on the water quality.

*E. coli* should not be detected in a supply classed as secure. However, if it is, the actions that need to be taken will depend on the number of samples in which the indicator has been found. The consequences of *E. coli* detection in the water are given in section 4.5.5 of the DWSNZ and are discussed in the next section.

### 3.2.4.6 Response to *E. coli* detection

Section 4.3.9 and Figure 4.1 of the DWSNZ cover the responses that must be followed when finding *E. coli* in any sample of drinking-water entering the distribution system. For bore water supplies, there are additional requirements.

Section 4.5.5 of the DWSNZ describes the response should *E. coli* be found in bore water. This involves:

- additional *E. coli* testing (confirming bore water security criterion 3)
- checking the chemical consistency (confirming bore water security criterion 1)
- a sanitary inspection of the bore head (confirming bore water security criterion 2).

A secure bore water that only has one sample containing *E. coli* is reclassified as provisionally secure for the following 12 months. That means a faulty result will not require expensive treatment to be installed. If *E. coli* is obtained in another sample during this 12-month provisional period, the water must be reclassified immediately as non-secure. If a secure bore water is classified as provisional more than twice in five years, retention of its secure status will be at the discretion of the DWA.

If bore water that has been given interim secure status (section 4.5.2.3 of DWSNZ) contains *E. coli* in any sample, the 12-month interim sampling regime must recommence. If *E. coli* is found in a second sample during the 12-month interim period, the water must be reclassified immediately as non-secure. Because the bore water no longer complies with the bacterial compliance criteria, it will need to be disinfected. Non-secure bore waters also require treatment to satisfy the protozoa compliance criteria in the DWSNZ.

Section 4.5.5 of the DWSNZ also specifies the actions to be followed if *E. coli* is found in the bore representing multiple bores drawing from the same field.

### 3.2.4.7 Grandfathering

This section applies to bores that have been in use for some time and have a monitoring history, but whose secure status has not previously been determined, or where the secure status may have been given in error.

Water suppliers may present to the DWA for consideration the full history of a bore's *E. coli* monitoring and test results, along with all other relevant information. If these results indicate that Bore water security criterion 3 is highly likely to have been satisfied, *E. coli* samples may be collected quarterly for compliance monitoring, as per note 5 to Table 4.5 in the DWSNZ.

To be granted full secure status, bore water security criteria 1 and 2 must have been satisfied in the previous five years.

Some guidance is offered regarding the number and frequency of samples required.

In the normal process, once a bore supply satisfies the requirements for being given **interim secure status**, water from the bore must be monitored at least as follows:

- a) weekly/twice weekly/daily depending on population (= 13, 26 or 90 samples in three months)
- b) if no *E. coli* found for three months monitoring as in a) – monitoring can be reduced to monthly, regardless of population (= another nine samples in nine months)
- c) if no *E. coli* found for nine months monitoring as in b) – bore water criterion 3 is satisfied. If criteria 1 and 2 are satisfied, the bore supply can be called **secure**.

That means an interim secure bore needs 22, 35 or 99 *E. coli*-free samples in 12 months, depending on population, before it can be called secure.

Thereafter, the secure bore water must be monitored for *E. coli* for evermore. For the first 12 months after having been given secure status, the monthly monitoring continues. If no *E. coli* is found during that 12-month period, monitoring can become quarterly.

That means a bore that is given interim security and then becomes secure will need at least 34, 47 or 111 *E. coli*-free samples before being allowed to reduce to quarterly sampling.

For these bore supplies (as per paragraph 1 of this subsection), a DWA could consider accepting three years of monthly, nine years of quarterly, or 18 years of six-monthly *E. coli*-free samples. These three examples require 36 consecutive *E. coli*-free samples.

It is more serious for those bores that would normally need a five-year proving period. Ideally these bore supplies shouldn't be grandfathered. However, some may have been given secure status incorrectly, so to avoid having to disinfect for five years, an alternative is suggested. Normally, to satisfy Bore water security criterion 3, these bores would need at least 70 *E. coli*-free samples over a five-year period. Therefore based on the previous paragraph, it is suggested that six years of monthly, or 18 years of quarterly, or 36 years of six-monthly *E. coli*-free results may be an acceptable alternative.

## 3.2.5 Operations and maintenance

### 3.2.5.1 The groundwater source

A secure bore water supply has a lower risk of *E. coli* contamination compared with non-secure bores, but it does not mean there is no risk. That is why Bore water security criterion 1 needs to be confirmed five-yearly (annually if using the physicochemical option), bore water security criterion 2 needs to be confirmed annually, and bore water security criterion 3 needs to be met quarterly. That will satisfy the DWSNZ. But there is a difference between meeting the DWSNZ, and managing a water supply.

Despite drawing from a confined aquifer, it may still be possible for bore water to fail to satisfy the requirements of Bore water security criterion 1. This may be because the:

- bore is too close to the recharge area
- confining layer is not extensive enough (wide or deep or intact) to be effective
- main aquifer is receiving water from a subsidiary aquifer that is not confined or contains 'young' water
- aquifer may draw in other water due to over-pumping by the bore or nearby bores
- statement that the bore is drawing from a confined aquifer may have been wrong, or that conditions have subsequently changed.

Callander et al (2014) describe how bore water that had been considered to have a very low risk of contamination (equivalent to a secure supply) drawing from a confined aquifer appears to have become contaminated by water from an unconfined section of the aquifer after some excavation de-watering activities and possible sewer leakage in the capture zone. They gave a second example of microbiological contamination of secure bore water following construction of soakage pits 300–400 m upgradient of the affected bores.

These cases illustrate the need for water suppliers to know as much as possible about the aquifers they are using and the recharge (capture) areas. They (and the regional council) also need to assess the likely outcomes of activities in recharge areas and land use changes, just as they would for a river water source.

Because of the possible adverse effects of earthquakes, volcanic eruptions and floods, the microbiological and chemical quality of groundwater after such an event should be checked immediately, and for up to a year after a major event because the effects may take some time before reaching the abstraction point (several months or years). Changes in water level or pressure can also indicate a change in an aquifer.

The regular testing for *E. coli* required by the DWSNZ for secure supplies may identify a change in water quality, but these tests are infrequent and episodes of faecal contamination may be missed. Frequent, regular (or online) monitoring of the temperature and conductivity of the bore water will provide an additional check for changes in water quality. Turbidity monitoring has also proved to be a useful tool for detecting changes. These tests are rapid and inexpensive, and by charting the results changes will become apparent. These should be used as a signal that closer investigation of the security of the bore is needed, and that an increase in testing of the water's microbiological quality should be undertaken. Regular monitoring of bore

water conductivity is a valuable check on the groundwater quality, and significant changes in any bore, secure or not, shows that something has changed and may require attention.

### 3.2.5.2 Meeting bore water security criterion 1

Secure bore water should not be affected by surface or climatic influences. There are three methods for demonstrating this:

- 1 residence time (age test) – preferred
- 2 physicochemical consistency – where the age test produces unclear results
- 3 verified model – where the above tests are unsuitable.

A sample of groundwater does not have a discrete age. Mixing processes underground ensure that any sample of water consists of a mix of waters of various ages. The age test is pragmatic rather than absolute. Some results may be unclear; see section 3.2.4. In time, the models used for this approach may be refined. Bore waters with unclear age test results may still be granted secure status.

The constant chemical composition test may also produce variable results. This may be because the aquifer **is** affected by surface or climatic influences, or the groundwater composition may vary depending on the relative contributions from river and rainfall; see section 3.2.3.1.

There seems to be two types of secure bores:

- a) those that clearly produce old water, are deep and occur beneath an extensive low permeability confining stratum with constant above ground artesian pressure with an upward hydraulic gradient, have extremely consistent chemical composition, unvarying temperature, never contain *E. coli*, have total plate counts <5 per mL, and even more so if the dissolved oxygen content is zero and the nitrate-N content is less than ammonia-N
- b) those where the age test does not give clear cut information. These bores often have variable chemical composition, contain some dissolved oxygen, the temperature shows seasonality, nitrate-N is usually higher than ammonia-N, and they are not always particularly deep. Callander et al (2014) stated: “Variable results in groundwater age determinations indicate bores that may have a higher risk of contamination, as do the detections of total coliforms”. The age tests on both bores discussed above by Callander et al were described as producing variable information.

Bores that belong in the second group need additional surveillance. Online monitoring of the temperature and/or conductivity of the bore water will provide an additional check for changes in water quality. Monitoring for total coliforms as well as *E. coli* will give an indication of ‘surface influences’.

### 3.2.5.3 Commissioning

Generally, new bores undergo a lot of pump testing and maybe screen development. By the time that has finished, the bore should be well and truly flushed out, so the water should be able to be used following a satisfactory *E. coli* result.

Following repairs or maintenance, it is recommended that samples be tested for total coliforms because this test is more sensitive than *E. coli* for indicating whether the bore water is directly affected by surface influences. The amount of flushing required will depend on the reason for the repairs. This should be covered in the Water Safety Plan.

### 3.2.5.4 Changes due to the bore

Changes in water quality and quantity from a bore can result from changes, notably including chemical incrustation, biofouling and corrosion. Section 3.2.4.3 includes discussion about backflow protection.

- a) **Chemical incrustation:** Disturbance of chemical equilibria that control the solubility of compounds in the groundwater can result from drawing water from the aquifer. Substances that have been dissolved but are just on the edge of remaining dissolved can be precipitated.

Precipitation may occur at screen slots where water velocities are high, and disturbance of the equilibria is greatest. This reduces bore capacity, but increases the water velocity through the slot because of its smaller size. Fine particles entrained in the higher velocity water then act to erode the screen. Precipitation may also occur in the aquifer material around the screen, which cements sand grains together and reduces the flow of water into the bore.

The substances most commonly associated with chemical incrustation are calcium carbonate and the insoluble hydroxides of naturally-occurring iron and manganese. Warm groundwaters can deposit silica.

Actions that will help reduce incrustation problems are:

- use of the maximum possible slot area in the screen. This reduces flow velocity through the slots, and therefore the degree to which chemical equilibria are disturbed
- thorough development of the bore
- use of minimum pumping rate (because of the influence of flow velocity on chemical equilibria)
- use of a number of small bores rather than one, or a few, large bores
- frequent maintenance and cleaning of the bore; preventive maintenance is preferable to drastic corrective actions.

Mechanical methods such as wire brushing or scraping, or controlled blasting, can be used to remove incrustation that does develop, but the most effective method is the use of strong acid, such as hydrochloric acid (requiring careful handling and flushing). Ultrasonic cleaners may have a role to play too.



- b) **Biofouling and regrowth:** Biofouling of screens most often occurs as the result of infection of the bore by iron bacteria. The organisms mainly responsible for biofouling catalyse the oxidation of soluble iron and manganese in the water, and as a by-product produce slimes containing large amounts of ferric hydroxide. As well as affecting bore yield, this phenomenon degrades water quality with respect to taste, odour and organic matter content (which increases the disinfectant demand of the water).

For biofouling to develop, most micro-organisms need a bore that is open to the atmosphere (for oxygen), sufficient concentrations of iron and/or manganese in the water (a level of iron of less than 0.1 mg/L is usually too low for iron bacteria to survive) as well as dissolved organic matter, and bicarbonate ions or carbon dioxide. Some micro-organisms can extract their oxygen requirements from chemicals such as nitrate and sulphate. The problem seems to be worse with intermittently used bores, or bores that are used seasonally. The end-products of this reduction process include ammonia (which will increase the chlorine demand) and hydrogen sulphide (which makes the water smelly).

Steps to prevent problems with iron or manganese bacteria include:

- disinfection of drill rods, bits, and tools to avoid cross-contamination from previous drilling activities (50–200 mg/L FAC)
- preparation of drilling fluid with chlorinated water (initially 50 mg/L FAC, but a minimum of 10 mg/L FAC must be maintained)
- the bore, once completed, must be sealed to prevent entry of airborne bacteria.

One proprietary system prevents growth of iron bacteria by starving them of the dissolved iron they need. The system works by injecting aerated water, degassed of carbon dioxide, into the aquifer through a field of aeration bores surrounding the production bore. The increased oxygen level in this water assists naturally-occurring bacteria that oxidise iron and manganese to remove these metals from the water by precipitating their oxidised form. Plugging of the surrounding aquifer material does occur, but at a much lower rate than would result from biofouling.

As well as iron and manganese bacteria, bacteria that are released into the water can give rise to positive total coliforms results. Regrowth can result from bacteria that live in the aquifer attaching to the screen, the surface of the casing or fittings, or even the sample tap. Regrowth can also result from surface contamination or subsoil water at the bore head.

Treatment of the water with a chemical disinfectant, such as chlorine, is the best approach to reducing biofouling and regrowth once it has occurred. Details of the procedure can be found in Driscoll (1986), AWWA (2013) and the Centers of Disease Control and Prevention (see [http://www.cdc.gov/healthywater/emergency/safe\\_water/wells/](http://www.cdc.gov/healthywater/emergency/safe_water/wells/) – accessed in 2010). AWWA (2004) discusses the biology, ecology, identification and control strategies.

- c) **Corrosion:** Corrosion of bore materials is a consequence of the chemistry of the water (either side of the bore) and can result in pinhole corrosion or can affect broad areas of the material. This may allow ingress of lower quality water. The rate at which it occurs generally increases with increasing concentrations of constituents such as carbon dioxide, oxygen, hydrogen sulphide, chloride, sulphate and the total dissolved solids content of the water. Acidic pH levels (ie, lower levels) are more corrosive to most materials than an alkaline pH. Corrosion of steel pipes has been known to occur during storage, even before becoming part of the bore.

The main types of casing used in bores are:

- steel
- uPVC
- ABS
- FRP and FRE
- stainless steel.

Each of these has different properties in relation to column, collapse and tensile strengths, resistance to corrosion, reaction to ground and water chemistry, and temperature. For corrosive water, PVC-U, ABS, FRP, or stainless steel casing provides the longest life possible. Because of the many and sometimes conflicting factors involved in selecting the most suitable casing material, the driller should consult with the manufacturer/supplier and bore owner before selecting the casing (NUDLC 2012).

Electrochemical corrosion can also affect bores (Driscoll 1986). This type of corrosion results from differences in electrical potential on metal surfaces. The potential difference may arise between two different metals, or on two different areas on the same metal surface. To minimise the likelihood of failure of the bore from electrochemical corrosion, care is needed in selection of the materials used, contacts between different materials, and factors that may lead to potential differences on the surface of the same metal, such as heat-affected areas near welded joints, heated areas near torch-cut slots, work-hardened areas around machine cut slots, exposed threads, and breaks in surface coatings (eg, paint).

Changes in the bore that can result from corrosion are:

- the development of sand pumping as the result of the enlargement of screen slots or the development of holes in the casing
- structural failure of the bore screen or casing because of their reduced strength
- reduced yield because of the blocking screen slots by corrosion products
- ingress of poor quality water through corrosion of the casing
- high iron levels in the water.

The ingress of poor quality water is the result of greatest concern with regard to the safety of the water. Perforation of the casing has the potential to allow water from shallow unconfined aquifers, carrying water of unsatisfactory microbiological quality, into the bore water. A potentially secure groundwater source may, through this mechanism, become unsafe without the water supplier being immediately aware of the degradation in water quality.

Corrosion and its control are complex subjects, and expert advice is valuable in ensuring the bore is constructed in a way that will minimise corrosion, and in assessing the steps necessary to minimise corrosion after bore construction. Some discussion on corrosion processes appears in Chapter 10: Chemical Compliance, section 10.3.4.

- d) **Permeation:** Some plastic materials used for casings allow low molecular weight compounds such as solvents and petroleum products to permeate into the water; metallic casing may be needed if a bore casing is to pass through such a contaminated area (AWWA 1997).

### 3.2.5.5 Maintenance

Once a secure bore head has been commissioned, its security needs to be maintained. The status of the bore head should be reported to the DWA annually. The information required includes the adequacy of the surface seals and/or caps, integrity of materials, observations about any contaminant sources located in the immediate area of the bore (eg, storage of hazardous compounds, stormwater or effluent discharges, the application of pesticides, or animal wastes near the bore), and anything that may be important like a change in pressure or flow.

In addition, whenever a bore water sample is taken for testing, the integrity of the bore head should be checked and recorded. Any problems (eg, vandalism, earthquake or other physical damage or change) should be reported immediately, followed by additional sampling to see if the water quality has been affected. Where possible, steps should be taken to protect the bore head from accidental damage. For example, protective barriers (for physical protection rather protection against faecal contamination) should be placed around bore heads located where they may suffer damage by vehicles. This step is designed primarily to ensure security of supply.

There are several reasons for a bore to be closed down for maintenance, such as camera inspections, repairing or replacing the pump, screen or casing, extending the depth, or repairs following an earthquake or flood. As discussed in Chapter 16 for mains repairs, procedures for these various activities should be covered in the Water Safety Plan. It is recommended that the Water Safety Plan should also include samples to be tested for total coliforms as well as *E. coli*, to aid in determining any changes in the risk to the water supply.

Where there is doubt about bore integrity there are a number of techniques, such as casing pressure tests and down-hole photography, which could be used but are likely to be beyond normal requirement. In general, above ground visual inspection and bore construction data would provide sufficient information.

Secure bore water simply means lower risk bore water (but not “no risk”). Bore water may go very long periods without *E. coli* being detected in samples. However, for various reasons, *E. coli* may be found in consecutive samples. It may be wise to disinfect the bore. One technique is to insert a narrow diameter pipe down the borehole and then to pump in a strong chlorine solution in an attempt to kill off any contamination. Alternatively, the strong chlorine solution can be poured down the bore. If the contamination persists after this, a permanent disinfection system will be

needed. See WHO (2011a) and the Centers of Disease Control and Prevention (US Government) web page for a helpful procedure. ([http://www.cdc.gov/healthywater/emergency/safe\\_water/wells/](http://www.cdc.gov/healthywater/emergency/safe_water/wells/) – accessed in 2010).

Checks on water quality should also be made after other events causing physical damage to bore heads, such as damage by a vehicle or vandalism. WHO (2011a) includes a Technical Note covering cleaning and disinfecting bores.

## 3.3 Surface water

Surface freshwaters (rivers, streams, lakes and impoundments) comprise those natural waters that are open to the atmosphere and contain only relatively small quantities of dissolved materials; generally (in New Zealand) much less than 1000 mg/L (Harding et al 2004).

Section 3.2 discusses groundwater. The DWSNZ treat springs as surface water, so they are discussed in this section. Rainwater (usually roof water) is discussed in Chapter 19: Small and Individual Supplies.

The convenience of having readily available and accessible sources of water rapidly renewed by rainfall is offset somewhat by the susceptibility of surface waters to pollution from a variety of diffuse and point sources. Point sources are clearly identifiable, have specific locations, and are typically pipes and drains discharging wastes (Davies-Colley and Wilcock 2004).

In most catchments used for water supply, pollution will be from diffuse sources, arising from land-use activities (urban and rural) that are dispersed across a catchment (Novotny 2003). Diffuse sources include surface runoff, as well as subsurface drainage, resulting from activities on land. The main categories of diffuse pollutants are sediment, nutrients and pathogenic micro-organisms. Other categories of diffuse pollutants are heavy metals (principally from urban land) and pesticides (mainly from agriculture and horticulture). Water UK (2012) summarises helpful ideas for catchment protection.

The Parliamentary Commissioner for the Environment (PCE 2012) published an excellent report that describes in a simple, readable manner, the relationship between land use and water quality in New Zealand. Landcare Research has developed the New Zealand Forest and Agriculture Regional Model (NZ-FARM), see: <http://www.landcareresearch.co.nz>

A summary of human activities that impinge on the suitability of freshwaters for potable water is given in Table 3.5. Note that birds may be a significant source of faecal pollution in surface waters as indicated by standard faecal indicators (eg, *E. coli*), and shed pathogens (eg, *Giardia* cysts, *Salmonellae* and *Campylobacter*) (McBride et al 2002).

**Table 3.5: Human activities and associated inputs into freshwater ecosystems with human health risks**

| Activity                                     | Contaminants   | Health risks  |
|--|--|---|
| Agriculture and horticulture                 | Sediments<br>Nutrients<br>Pesticides and other toxic chemicals and metals<br>Faecal microbial contaminants | Immune and endocrine disruption<br>Retarded physical and cognitive development, blue baby syndrome<br>Foetal malformation and death |
| Industry                                     | Nutrients<br>Toxic chemicals and metals<br>Oils  | Nervous system and reproductive dysfunction<br>Behavioural changes<br>Cancers   |
| Mining                                       | Sediments<br>Toxic chemicals and metals  | Waterborne disease  |
| Urbanisation, infrastructure and development | Sediment<br>Pesticides and other toxic chemicals and metals<br>Oils<br>Faecal microbial contaminants       |   |
| Recreation                                   | Oils and fuel<br>Toxic chemicals   |   |

Modified after Slaney and Weinstein 2004.

### 3.3.1 Rivers and streams

About half of New Zealand’s drinking-waters are pumped from the ground, with the remainder coming from surface sources (MoH 2003). Flowing waters (rivers and streams) are thus an important source of supply in New Zealand and there is a need to ensure that adequate quantity and quality is maintained in order to provide a reliable and safe source.

#### Water quantity

It is advantageous to have a good understanding of the flow (or hydrologic) regime of a river selected for water supply. The regime defines the character of a river, how liable it is to floods or to have long periods of low flow, and whether it is useful for the purpose of water supply, and whether impoundment is necessary to provide the volumes required (Duncan and Woods 2004). The continuous time-series record of river flow (hydrograph) can be analysed to estimate the incidence of extreme flows as well as the response of flows to rainfall events.

During low flows there may simply not be enough water for supply, and intakes may even be above low water levels.

During flood flows, water quality is often poor due to sediment discharged in high concentrations, along with other contaminants, notably faecal micro-organisms, and coarse floating material (logs, etc) that are potentially damaging to intakes are often present.

Routine monitoring of New Zealand river flows began between 1900 and 1930 for hydroelectric power generation, and from 1930 for designing flood protection works (Pearson and Henderson 2004). The National Hydrometric Network (Pearson 1998) is a key source of New Zealand stream and river flow data, and is complemented by monitoring networks operated by regional and district councils (Pearson and Henderson 2004).

Flow extremes, such as the frequency of floods of a given return period, or the mean annual seven-day low flow, are useful in this respect and have been summarised for many New Zealand rivers (eg, Hutchinson 1990).

Flow regimes are perhaps most simply linked to the flow-duration curve, a cumulative frequency plot of flows that shows the proportion of time during which flow is equal to or greater than given magnitudes, regardless of chronological order. The overall slope of flow-duration curves indicates the flow variability of rivers. Clearly rivers that have fairly steady flow (eg, owing to spring or lake sources) are preferable for supply to highly flow-variable (flashy) rivers. Flow-duration curves at the extremes are often fitted to analytical distribution functions for the purpose of analysing risk of floods and low flows. For example, annual seven-day low flows are often well-fitted by a log-normal distribution (Pearson and Henderson 2004). Flow regimes are affected by climatic cycles, notably the El Niño-Southern Oscillation (ENSO), with stronger westerly winds and more rainfall in the south and west during El Niño periods and less rainfall in the south and west and more in the northeast during La Niña periods (Scarsbrook et al 2003).

## Water quality

Water that has not yet been treated and is to be used for domestic supply is referred to as raw water, in contrast with treated water that has passed through some form of treatment (eg, filtration, disinfection). Drinking-water standards and guidelines mostly apply to treated waters.

There are few chemical constituents of water that can cause health problems from a single exposure, except through massive accidental contamination of a drinking-water supply (WHO 2004). Where short-term exposure to a contaminant does not lead to health impairment, it is often most effective to focus remedial action on finding and eliminating the source of contamination, rather than on treating the water for removal of the particular chemical constituent (WHO 2004).

Most chemicals posing a health risk are of concern only when long-term exposure occurs at concentrations above the MAV, and where treatment to remove the chemical is not employed (eg, Table 3.6). At times when flows and velocities are low, dissolved oxygen in small streams may be very low because of sediment oxygen demand and insufficient reaeration (Wilcock and Croker 2004). At such times appreciable concentrations of soluble, reduced forms of iron and manganese may be released from anoxic sediments or from groundwater inflows which, on contact with air, readily convert to insoluble oxide precipitates that have to be removed during water treatment because they impart unpleasant metallic flavour to water and deposit reddish-brown (iron) or black (manganese) stains.

**Table 3.6: Some chemical constituents in untreated surface water used for drinking-water supply that present a potential problem**

| Constituent of concern   | Associated problem  |
|--|---|
| Arsenic (As)   | Cancer, skin lesions  |
| Fluoride (F <sup>-</sup> )   | Mottling of bones and teeth, fluorosis  |
| Nitrate and nitrite (NO <sub>3</sub> <sup>-</sup> + NO <sub>2</sub> <sup>-</sup> ) | Methaemoglobinaemia for bottle-fed infants. Note that this has been disputed recently, see Lundberg et al (2004) and Addiscott et al (2004) |
| Dissolved organic carbon   | Trihalomethanes produced by chlorination may be toxic, carcinogenic   |
| Iron (Fe), manganese (Mn)  | Unpleasant taste, discoloration caused by oxide precipitates  |

Other water quality chemical variables are important with regard to operational requirements when water is treated for supply. These include: pH (a measure of the aggressiveness of water with respect to corrosion), alkalinity (capacity to buffer natural waters against pH change), total hardness (mainly divalent ions like Ca<sup>2+</sup> and Mg<sup>2+</sup> that may be prone to forming precipitates), humic substances that impart undesirable colour to water and can influence corrosion of copper, and total dissolved solids (affects palatability when greater than about 1000 mg/L).

Typical New Zealand rivers and stream waters can be described as being dilute (low total dissolved solids), soft (having low concentrations of Ca<sup>2+</sup> and Mg<sup>2+</sup>), with slightly acidic to slightly-alkaline pH, and weak buffering (low-moderate alkalinity). They may be broadly described as calcium-sodium-chloride-bicarbonate waters (Close and Davies-Colley 1990). There are some notable exceptions to this where, for example, pH is low and bicarbonate alkalinity is high, or total hardness exceeds 100 mg/L as CaCO<sub>3</sub>. These are generally well-documented through the regular surveillance programme of surface waters used for drinking-water supplies, operated by the Ministry of Health (MoH).

Microbial pollutants are generally of greater relevance to New Zealand surface waters than chemical pollutants. Most microbiological agents of disease (pathogens) are derived from the faeces of warm-blooded animals including humans. The presence of pathogens in waters is sporadic, only occurring when waters are polluted by faecal matter from sick individuals or carriers.

The Freshwater Microbiology Research Programme (McBride et al 2002) involved the monitoring of 22 river and three lake sites for a suite of pathogen and indicator organisms, fortnightly for 15 months (1998–2000). Of the 25 sites, five were source waters for treatment as community drinking-water supplies, of which three were also recreational sites. Pathogenic viruses and *Campylobacter* were detected at least once at all sites and there was little difference between the drinking-water supply sites and the other sites with respect to the occurrence of pathogens and concentrations of faecal indicator organisms.

The main issue for source waters was the high proportion of samples that contained *Campylobacter* (60 percent) and viruses (54 percent) and the ability of drinking-water treatment to kill (or inactivate) or remove them (McBride et al 2002).

Routine testing for pathogens is seldom conducted because a wide range of pathogens might conceivably be present, but the tests are expensive at the required detection levels so testing for several pathogens in each sample quickly becomes prohibitive. Instead, microbiological indicators of faecal pollution, such as the bacterium *Escherichia coli* (*E. coli*) that is ubiquitous in faecal matter, are used also as indicators of disease risk. See Chapter 5.

Lowland streams in New Zealand continue to receive discharges from community sewage schemes, farm oxidation ponds and other point sources (NZWWA 1998; Wilcock et al 1999), but diffuse sources of faecal pollution are now generally dominant.

Faecal contamination of streams can be very high during floods owing to mobilisation of contaminated sediments and wash-in from contributing land areas of catchments. For example, *E. coli* concentrations of 41,000 MPN/100 mL were measured in a flood event in an agricultural stream, compared with a pre-flood level of about 100 MPN/100 mL (Nagels et al 2002).

Diffuse faecal microbial pollution from pastoral agriculture may come from runoff (eg, from farm raceways), livestock accessing unfenced streams, and cattle crossings of streams (Davies-Colley et al 2004). Thus, it is important that key land uses within the catchment of rivers being used for water supply are known so that implications for water treatment are understood. Some median concentrations reported for New Zealand streams and rivers are shown in Table 3.7. Sediments are the main reservoir of faecal contamination with concentrations of *E. coli* approximately 1000 times baseflow levels (Muirhead et al 2004). These sediment stores are mobilised by storm-flows that may have much higher (100 times) *E. coli* concentrations than base flows (Nagels et al 2002). See also section 8.2.1 of Chapter 8 for further monitoring results.

**Table 3.7: Faecal contamination in a range of New Zealand streams and rivers**

| Region   | Land use      | Median <i>E. coli</i> (number per 100 mL) <sup>1</sup> | Reference                       |
|--|---------------|--|---------------------------------|
| Whanganui catchment tributaries (steep hill country) | 100% pasture  | 830 <sup>2</sup>                                       | Davies-Colley & Stroud (1995)   |
| Waikato hill-country                                 | Pasture       | 400  | Donnison et al (2004)           |
|  | Native forest | 100  |                                 |
|  | Pine forest   | 83   |                                 |
| Waikato lowland                                      | Dairy         | 280–440  | Davies-Colley and Nagels (2002) |
| Westland lowland                                     | Dairy         | 60–1000  | Ibid                            |
|  | Native forest | 4  |                                 |
| Low-elevation rivers throughout New Zealand          | Pasture       | 700  | Larned et al (2004)             |

1 Note that these data are from fixed-interval sampling and are generally taken at low-flows. Flood-flow concentrations may be 100-fold higher.

2 Based on a median faecal coliform concentration of 920 cfu/100 mL, assuming about 90 percent *E. coli*.



### 3.3.2 Lakes and reservoirs

Lakes and reservoirs are used to store water during runoff periods for use during other times of the year. The water in the reservoir is used to supply the needs of municipalities, industrial users and the farming community, and can also be used to protect aquatic life by maintaining a continual flow in the stream downstream of the reservoir.

Issues related to land-use and lake management were covered in the *Lake Managers' Handbook* which was published by the Ministry of Works in 1987 and is still widely used and highly regarded by lake managers and others involved in water management. Aspects of this publication were updated by MfE in 2002. NIWA produced *Guidelines for Artificial Lakes* in 2012. The Guidelines provide a range of management strategies required to produce the highest possible lake water quality in a new lake and how to improve water quality in existing degraded artificial lakes.

An impoundment can range in size and impact from:

- a weir where the water supplier takes 'run of flow'; this is usually when the required water volume is small compared with the flow in the river,

to:

- a multi-day retention impoundment; this is usually a stream, where winter flows are stored to meet the summer water demand.

A weir does not change the water quality very much. A multi-day retention impoundment can modify the water quality in the impoundment and downstream, and the quality of the water in the impoundment can vary with depth, see Chapter 4: Source and Treatment Selection, section 4.4.1. Off-river storage is discussed in Chapter 12: Pretreatment Processes.

Excessive productivity of phytoplankton (eutrophication) is probably the main water quality problem in New Zealand lakes and is manifested by algal scums, turbid waters, deoxygenation of bottom waters, unpleasant tastes and odours, and excessive macrophyte (aquatic weed) growth (Vant 1987).

Blooms of blue-green algae (cyanobacteria) may release toxins at a level that is harmful to human health when critical concentrations (about 15,000 cells/mL for contact recreation) are exceeded, see Chapter 9.

Phytoplankton blooms can also impart unpleasant taste and odours to water that may require costly forms of treatment. Faecal contaminants are less problematic in standing waters than in rivers and streams, because of inactivation by lengthy exposure to sunlight and other inactivation processes, predation and sedimentation (Auer and Niehaus 1993).

Algal blooms occur in lakes with high nutrient concentrations, such as those in pasture catchments, during periods of calm, fine weather when high sunlight and stratification permit algal cells to occur. Elevated concentrations of nutrient elements (N and P) are associated with intensification of agricultural land. Furthermore, diffuse runoff from farms contributes inputs of faecal matter and potentially, pathogens. Thus it is

important that impounded waters being used for drinking-water supply have in place ways of intercepting runoff, such as riparian buffer zones that trap N, P and faecal microbes; protected wetlands that enhance N removal by denitrification; and adequate fencing to keep stock away from waters and hence, minimise inputs of faecal matter (Williamson and Hoare 1987). These issues are explored more fully in section 3.5.1.

Prevention by riparian strips and control of land use etc is more effective than using algicides such as copper sulphate. Algicides have difficulty in removing an algal bloom; they are more effective at preventing a bloom if dosed early enough. Risk management issues relating to algicides are discussed in the MoH Public Health Risk Management Plan Guide PHRMP Ref. P4.1: Pretreatment Processes – Algicide Application.

A commercial product, Phoslock™, has been developed in Australia to remove phosphorus from water. Phoslock™ is a reaction product of bentonite clay and lanthanum chloride in which the proportion of exchangeable cations (mainly sodium) is replaced by lanthanum cations through electrostatic binding. Phoslock™ is designed to adsorb oxyanions, predominantly phosphate, from a variety of natural aquatic environments notably in order to reduce the incidence of algal blooms. The recommended dosage is 100:1 Phoslock™ to filterable reactive phosphorus (FRP). Bentonite has been used in the past as a coagulant aid. Lanthanum is not normally found in significant concentrations in natural waters, and is not normally added. NICNAS (2014) has assessed the use of Phoslock™. The Guidelines include a datasheet for lanthanum.

A report of three applications of Phoslock™ in appeared in McIntosh (2007). The plan involved lake treatment to remove phosphorus by 100 kg/year for three years. The author stated that the phosphorus load in the sediment has been reduced by nearly 100 kg/year with a strengthened phosphorus absorbing capacity of Lake Okareka expected for 3-4 years. After the Phoslock application the date when the deoxygenation of the bottom waters occurred was delayed by over a month. NIWA (2008) compared four P-inactivation agents.

Reservoir catchments that are predominantly native or plantation forest are likely to have lower specific yields (kg/ha/y) of pollutants such as sediment and nutrients (Table 3.8).

**Table 3.8: Specific yields (kg/ha/y) for different land uses in New Zealand**

| Land use                        | SS       | TN       | TP        |
|---------------------------------|----------|----------|-----------|
| Intensive dairy                 | 142      | 35       | 1.16      |
| Average grazed pasture          | 600–2000 | 4–14     | 0.3–1.7   |
| Urban development               | 200–2000 | 2.5–11   | 0.4–1.6   |
| Plantation forest – disturbed   | 300–2000 | 0.06–0.8 | 0.4–8     |
| Plantation forest – undisturbed | 500      | 0.07–0.2 | 0.15      |
| Native forest                   | 27–300   | 2–7      | 0.04–0.68 |

Source: Davies-Colley and Wilcock (2004). SS = suspended sediment; TN = total nitrogen; TP = total phosphorus

Rates of water movement in lakes (and reservoirs) are very slow by comparison with rivers and this permits water composition to change substantially between inflows and outflows as well as allowing large variations within different parts of a lake (Hamilton et al 2004). Density stratification related to gradients in water temperature within deeper lakes results in contrasting water chemistry in the upper (epilimnion) versus lower (hypolimnion) water layers.

The mean water residence time (in days) of a lake is given by:

$$\tau = V/Q$$

where Q is the outflow (m<sup>3</sup>/day) and V is the lake volume (m<sup>3</sup>).  $\tau$  varies from several hours to a few days for reservoirs behind dams on rivers, and to several years for lakes where the lake catchment is small relative to the lake volume (Hamilton et al 2004).

Phytoplankton are less of a problem in lakes and reservoirs with short residence times (weeks – months) because cells tend to be washed out faster than they can multiply (Howard-Williams 1987). For flushing to be effective as a means of controlling algal biomass, the lake inflow must be large enough, and there must be control facilities that allow the inflow to be regulated. Rapid flushing of lakes may prevent buoyant scums formed by blue-green algae, by creating instability in the water column (and reducing average light exposure and bicarbonate availability) through increased circulation. Other methods for reducing nutrient concentrations and thus lowering algal biomass in lakes include diversion of waters with high nutrient loads, and flocculation to strip P from the water column by converting it into a solid form that settles (eg, alum was used to strip P from Lake Okaro, in a trial in 2004).

At times when lakes are thermally stratified, hypolimnion waters may become deficient in dissolved oxygen (anoxic or anaerobic) causing many constituents to occur in a reduced state (eg, inorganic N will be predominantly NH<sub>4</sub><sup>+</sup>).

By comparison, the epilimnion is well-oxygenated through exchange with the atmosphere, and constituents are nearly always in an oxidised form (eg, NO<sub>3</sub><sup>-</sup> is the dominant form of inorganic N). Thus, waters drawn from deeper waters may undergo changes associated with oxidation, when passing through a water treatment plant.

The Hayes Creek reservoir (supplying Papakura District Council) has anoxic bottom waters containing reduced Mn<sup>2+</sup> that is readily oxidised to form black precipitates of MnO<sub>2</sub> on exposure to air. To prevent this, an oxygen curtain is deployed upstream of the water intake to oxidise the Mn before it gets to the treatment plant.

H<sub>2</sub>S from geothermal sources, or produced by anaerobic metabolism of SO<sub>4</sub><sup>2-</sup> in sediments, may produce the rotten egg smell associated with many highly reducing environments (Hamilton et al 2004). A recent example of this was H<sub>2</sub>S produced during decomposition of drowned vegetation and soils in the lake formed by the Opuha dam in South Canterbury (Hamilton et al 2004).

Lakes and reservoirs can be aerated purposefully in order to reduce stratification. A common result of destratification is an improvement in water supply quality (the first artificial circulation system was used in 1919 in a small water supply reservoir). By introducing oxygen to the (previously anoxic) hypolimnion, problems caused by reduced iron and manganese, and gases like H<sub>2</sub>S, are greatly reduced as well.

The purpose of aeration in lake management is to increase the dissolved oxygen content of the water. Various systems are available to help do this, either by injecting air, mechanically mixing or agitating the water, or even injecting pure oxygen. Aeration can increase fish and other aquatic animal habitats, prevent fish kills, improve the quality of domestic and industrial water supplies, and decrease treatment costs. In some cases, nuisance algal blooms can be reduced, or a shift to less objectionable algae species can occur. However, starting aeration after the nutrient levels have built up in the hypolimnion is likely to raise their concentration near the water surface, causing biological growth. Risk management issues relating to destratification are discussed in the MoH Public Health Risk Management Plan Guide PHRMP Ref. P4.2: Pretreatment Processes – Destratification.

See Chapter 12: Pretreatment Processes, section 12.3.2: Off-river Storage for further information, including some information re reduction times for selected micro-organisms.

### 3.3.3 Springs

Springs are sources of emergent groundwater and may have very long or very short path lengths from their source surface waters. When used for drinking-water supply, springs should provide a reliable (continuous) supply of water and be of suitable quality. Non-piped water supplies, such as water collected from bores or springs, may often be contaminated with pathogens and require special treatment to achieve safe supply (WHO 2004). Even if spring water has reached the surface from a great depth, it is likely to contain sub-soil water too. Springs can be contaminated at the point at which water issues from the ground, eg, if animals are permitted to graze nearby. Waterfowl may also contribute to high levels of *E. coli* around springs. Springs can also be contaminated by runoff from the catchment that they drain, or from the soils that surface water passes through before re-emerging in spring water. For example, springs draining the Bombay Hills market garden areas have high nitrate concentrations that sometimes exceed the drinking-water Maximum Acceptable Value (MAV) of 50 mg/L (as NO<sub>3</sub>) (Wilcock and Nagels 2001). Hickey Spring in Pukekohe was monitored from 1959 to 2015; the nitrate concentration steadily increased from 6.5 to 20 mg/L as N.

Geothermal springs may contain health-significant concentrations of toxic chemicals, ie, arsenic, mercury and sometimes, elevated levels of fluoride. Geothermal springs are not used for drinking-water supply in New Zealand but they do influence the chemical composition of Waikato River, which is a major water supply resource, by contributing significant levels of arsenic and boron. Median concentrations of As and B are 0.028 mg/L and 0.26 mg/L respectively, at the nearest upstream site to the Hamilton water treatment intake (Smith 2003). The drinking-water MAVs for these elements are 0.01 and 1.4 mg/L, respectively (MoH 2005). Some water supplies may be drawn from hydrothermal springs, where the water temperature is higher than expected. These should be tested for the chemicals mentioned above.

Risk management issues relating to springs are discussed in the MoH Public Health Risk Management Plan Guide PHRMP Ref. P1.4: Groundwater Abstraction – Springs.

## 3.4 Legislation

### 3.4.1 General

Catchment protection involves firstly defining the boundaries of the catchment and determining who is responsible for the catchment and the protection of the water quality. A catchment is the drainage area upstream of the raw water abstraction point, or the aquifer and recharge zone of a groundwater system. The *Resource Management Act 1991* allows (Schedule 2 Part 1 clause 1), but does not require, provision to be made in a District Plan for ensuring an adequate supply of water with regard to the subdivision of land. Steps taken to achieve this could include:

- leak reduction plans to be implemented before increased abstraction is allowed
- assessment of environmental effects of capital expenditure projects, including assessment of the costs they impose on present and future drinking-water supplies
- domestic water saving programmes
- industrial water use audits and water-use efficiency programmes
- development of alternative supplies
- restrictions on new subdivisions where the regional and district plans do not provide for an adequate drinking-water supply.

Under the *Local Government Act 2002* (Part 7, Subpart 1, sections 124–126) a territorial authority is obliged to assess the provision of water services and other sanitary services within its district, and describe the means by which drinking-water is obtained by residents and communities in the district, including the extent to which water supply is provided within the district by the territorial authority or other persons. It must also describe whether the water is potable (section 126(1)(i)(B)), and make an assessment of:

- any risks to the community relating to the absence in any area of either a water supply or a reticulated wastewater service or both (section 126(1)(b))
- the quality and adequacy of supply of drinking-water available within the district for each community (section 126(1)(c))
- a statement of current and estimated future demands for water services within its district (section 126(1)(d))
- any issues relating to the quality and adequacy of supply of drinking-water for each community (section 126(1)(d)(i))
- a statement of the options available to meet the current and future demands for drinking-water (section 126(1)(e))
- the suitability of each option for the district and for each community within it.

The territorial authority is also to provide:

- a statement of the territorial authority's intended role in meeting the current and future demands (section 126(1)(f)) identified in section 126(1)(d) and proposals for meeting the current and future demands identified in section 126(1)(d), including proposals for any new or replacement infrastructure.

A local government organisation that is defined under the Local Government Act 2002 to mean “a local authority, council-controlled organisation, or a subsidiary of a council-controlled organisation, that provides water services”, that provides water services to communities within its district or region must continue to provide water services and maintain its capacity to meet its obligations. It must not lose control of, sell, or otherwise dispose of, the significant infrastructure necessary for providing water services in its region or district, unless, in doing so, it retains its capacity to meet its obligations.

Local government organisations must not close down or transfer a water service unless there are 200 or fewer persons to whom the water service is delivered who are ordinarily resident in the district, region, or other subdivision; the opinion of the MoH has been made public; and 75 percent or more of the public have agreed.

A local government organisation may only close down a water service under section 131(1)(a) if it has first reviewed the likely effect of the closure on the public health of the community that would be affected by the closure (section 134(a)(i)); on the environment in the district of that community (section 134(a)(ii)); and assessed, in relation to each property that receives the water service, the likely capital cost and annual operating costs of providing an appropriate alternative service if the water service is closed down (section 134(b)); compared the quality and adequacy of the existing water service with the likely quality and adequacy of the alternative service referred to (in section 134(b)) identified above (section 134(c)).

A local government organisation may enter into contracts for any aspect of the operation of all or part of a water service for a term not longer than 15 years (section 136(1)).

A local government organisation may only transfer a water service under section 135 if it has first:

- developed a draft management plan under which the entity representative of the community would maintain and operate the water service
- assessed the likely future capital and operating costs of the entity representative of the community to maintain and operate the water service
- assessed the ability of the entity representative of the community to maintain and operate the water service satisfactorily.

Knowledge of localised hydrological conditions that contribute towards water quantity and quality are essential for the design and implementation of a catchment protection scheme. These conditions include natural inputs such as seasonal rainfall variations or regional geology, and man-made inputs such as agricultural chemicals, industrial and domestic wastes, erosion and animal activity. Once all factors contributing to water quality have been identified, the planning and design of a catchment protection strategy can commence. Landcare Research has produced a National Map of Soil Erosion, see: <http://www.landcareresearch.co.nz/science/soils-and-landscapes/ecosystem-services/factsheets>

The prime objective of a catchment management strategy, or planning for a drinking-water supply, should be to protect and, if necessary (and achievable), to enhance the quality of source waters. The rules in the plans define the activities that can take place in the catchment.

Current legislation allows for the protection of the quality and other aspects of the source waters. The predominant legislation under which this can be achieved is the Resource Management Act 1991 (RMA), with its key purpose as the sustainable management of natural and physical resources, and the Health Act 1956 (HA).

Regional councils have responsibility, under the RMA (s30(1)(c)), to control land use in order to protect the water quality within their respective catchments. Responsibilities include controls over the use and diversion of source water (RMA s30(1)(e)), discharge of contaminants into the water (RMA s30(1)(f)), and in relation to any bed of a water the planting of vegetation on land for the purpose of maintaining and enhancing of water quality of that water body (RMA s30(1)(g)). Regional plans, district plans and resource consents under the RMA are the main tools for managing the water quality of source waters.

However, although these tools are available under the RMA, they are frequently not used effectively. The provisions for drinking-water values in regional plans are an example of this. Thus, only six of sixteen regional councils or unitary authorities have a comprehensive approach to the management of drinking-water catchments. The other councils have either not addressed the issue, or have done so in a very general way (Ministry for the Environment 2004).

There is currently (2005) **no specific requirement** in the Resource Management Act for consent authorities to consider the impact proposed activities may have on source water in a drinking-water supply catchment. Consequently there is potential for land use activities/ discharges to be consented that reduce water quality at the point of abstraction to below that which the plant is designed to treat. This presents potential health risks to the community and may result in significant costs to the supplier in upgrading treatment facilities.

Part 7 (section 126) of the Local Government Act (2002) requires local authorities to undertake a specific assessment of the quality and adequacy of drinking-water supplies. However there is no requirement to manage source water quality, which is the aim of the National Environmental Standard (NES), see next section.

While section 5 of the Resource Management Act refers to social, economic and cultural well-being for people and communities, there is no **specific** requirement for consent applicants to consider the impact of their proposed activity on community drinking-water supplies. Whilst it can be argued that the definition of environment in the Resource Management Act includes public health, there is no specific reference to community drinking-water supplies in the Act.

The Ministry for the Environment has produced a National Environmental Standard under the Resource Management Act to improve how drinking-water is managed at source. This standard is intended to complement Ministry of Health legislation and standards for improving drinking-water supply and delivery; see section 3.4.2.

The Health Act 1956 allows the Governor General to declare, by Order in Council, any water supply source, whether publicly or privately owned and operated, to be under the control of a territorial authority if this is necessary in the interests of public health (HA section 61(2)). The Health Act also makes it an offence to create a nuisance or to allow a nuisance to continue (HA section 30) including allowing a water source to be offensive, liable to contamination, or hazardous to health (HA section 29(p)).

Catchments dedicated for water supply purposes and under the control (by ownership and/or declaration) of a territorial authority or regional council, may be controlled simply by the use of bylaws. The Model General Bylaws for Water Supply define appropriate management controls for the protection of water quality in such catchments (NZS9201: Chapter 7: 1994). There are circumstances where specific legislation has been developed that relates to water supply, for example the Wellington Regional Water Board Act 1972. This Act is an important statute for the regional council under which it holds large areas of land in the Wellington metropolitan area.

In other situations abstractions for water supply are often only one of many demands on the water resource. In this case the catchment management strategy or plan will need to be incorporated within the overall regional (or district) plan process.

The reliability of production of a continuous, adequate, supply of safe water from a large river or active catchment will be enhanced by use of off-river storage. This offers the ability to choose when raw water should be abstracted, thus avoiding periods when water treatment may be difficult, or when the river may be contaminated.

### 3.4.2 National Environmental Standards (NES)

For the multi-barrier principle to be implemented properly in the management of drinking-water supplies, the water supplier needs to be able to put barriers to contamination in place from the water source through to the consumer's property. In the past, this has been difficult for many water suppliers in New Zealand by legislation which separated responsibilities for catchment management from those of treatment and reticulation of water. The Resource Management Act (1991) makes regional councils responsible for the management of source catchments, while health legislation makes water suppliers responsible for the water supply from the point of abstraction to the consumer.

To ensure that the supply of water for drinking-water production is taken into consideration when decisions are made regarding activities in catchments, the Ministry for the Environment developed a national environmental standard for raw public drinking-water, ie, source water. The original proposal for this standard was that it be a grading standard. This approach did not require a minimum water quality to be achieved, but it proposed the generation of a grade for the raw water to assist communities in making decisions about the management of their water resources.



Following public consultation, the form of the NES was revised in early 2005. It is now a narrative standard. The National Environmental Standard for Sources of Human Drinking Water came into effect on 20 June 2008. The standard is intended to reduce the risk of contaminating drinking water sources. See MfE (2009): *Draft Users' Guide*.

The standard requires regional councils to ensure that effects on drinking-water sources are considered when making decisions on resource consents and regional plans. Specifically, the standard requires that regional councils:

- decline discharge or water permits that are likely to result in community drinking-water becoming unsafe for consumption following existing treatment
- be satisfied that permitted activities in regional plans will not result in community drinking-water supplies being unsafe for consumption following existing treatment
- place conditions on relevant resource consents requiring notification of water suppliers and consent authorities if significant unintended events occur that may adversely affect sources of human drinking-water.

The draft standard was refined following public consultation in 2005 and several key changes were made based on submissions received. These included:

- applying the consent component of the NES to water and discharge permits only
- assigning regional councils (not territorial authorities) the primary responsibility for implementing the majority of the standard (reflecting existing responsibilities and expertise in water quality)
- increasing the community water supply population threshold for application of the standard from 25 to 500 people, to reduce implementation costs.

The Ministry for the Environment will produce guidance material to assist regional councils and consent applicants apply the new standard.

The NES is a regulation, so it is binding and prevails over rules and resource consents. More details of the standard are available at the following link:

**<http://www.mfe.govt.nz/laws/standards/drinking-water-source-standard.html>**

The NES covers emergency notification provisions. Under the NES, emergency notification refers to the notification (preferably by phone) of authorities when an unintended activity occurs (this differs from the notification of a consent application under the RMA). One key difference between emergency notification provisions and previous parts of the regulation is that they now apply to a smaller population threshold: activities with the potential to affect registered drinking water supplies that provide 25 or more people with drinking water for 60 or more days of a calendar year must be notified.

## 3.5 Mitigation of pollutants and catchment protection

Water contamination may arise from a variety of sources, including seepage from pipelines, human and animal effluent, landfill leachate, industrial effluent disposal, use of pesticides and fertilisers, mining, leakage from underground tanks, transportation accidents, salt water intrusion, and poorly constructed bores or bore head protection, see Figure 3.3. Groundwater contamination usually occurs in a far less conspicuous manner than surface waters, and is discussed in section 3.2. This section discusses catchment protection and the mitigation of surface water contamination. Some nutrient and sediment control practices are discussed in MfE (2002). Refer also to Appendix 4 of MfE (2009): Activities and Contaminants that may Contribute to Source Waters.

If a river has the potential to receive contamination that the treatment plant is not designed to remove, consideration should be given to the use of off-river storage. Off-river storage is discussed in more detail in Chapter 12: Pre-treatment Processes. Chapter 4: Source and Treatment Selection also includes some discussion on catchment protection, mainly related to micro-organisms.

WHO (2016) covers catchment risk assessment, the various hazards, and their control. The link includes excellent editable checklists and tables.

**Figure 3.3: Catchment protection**

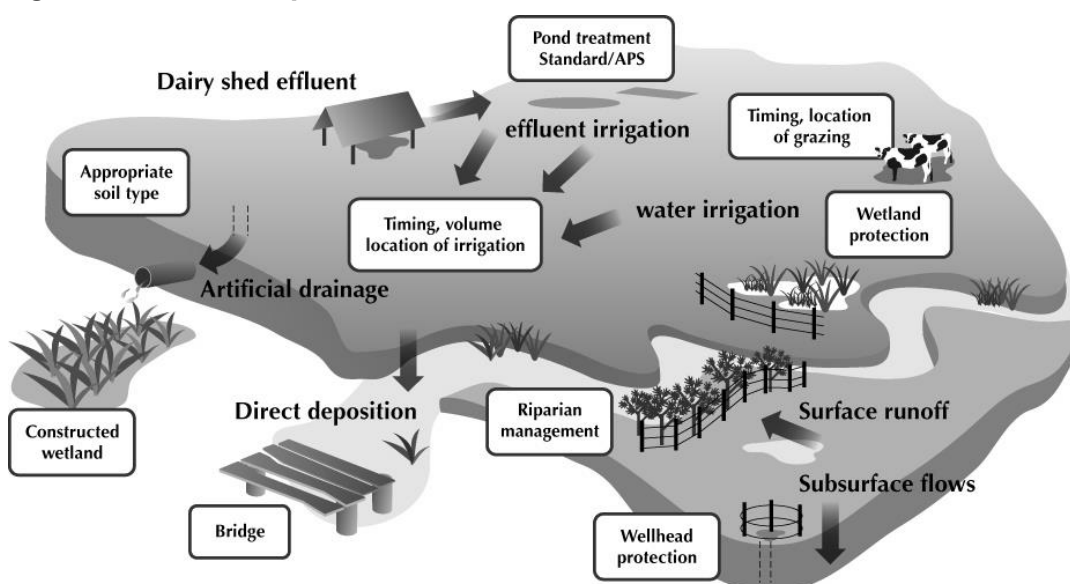

## 3.5.1 Rural activities

Whilst drinking-water catchments ideally should be devoid of inputs of human and animal waste, in reality total absence is rare. Typically, therefore, the water treatment process can benefit from attempts to mitigate such pollution at or near to its source. Wastes from animals are known to contain nutrients, pathogens, heavy metals and endocrine-disrupting chemicals, all of which can be transferred to water bodies by the deposition of urine and faecal material directly to a stream or lake, and via surface and subsurface flow pathways. MPI (2011) assessed the ammonia production from animal excreta.

A number of mitigation options exist to reduce this transfer, although the research to-date typically has excluded heavy metals and endocrine-disrupting chemicals, focusing upon sediment, nutrients and faecal microbes. However, treatment systems that effectively remove sediment might be expected to also remove metals (eg, cadmium from phosphatic fertilisers; zinc used for facial eczema treatment). If the water supplier owned the catchment, they would be able to control most land uses and activities. Some have done this, then converting from pastoral farming to forestry.

Nutrient levels, particularly nitrate have been increasing gradually in many waters for many years. Sewage can contain about 25 mg/L of ammonia, a lot of which ultimately is oxidised to nitrate. Agriculture activities also contribute nitrate (Landcare 2016):

| kgN/ha/yr              | Dairy | Apples | Grapes | Outdoor vegetables | Other pasture | Forest and scrub |
|------------------------|-------|--------|--------|--------------------|---------------|------------------|
| N-NO <sub>3</sub> loss | 24–69 | 3–18   | 4–18   | 16–51              | 10.7          | 2.5              |

### Farming (general)

The effect of agriculture on water quality is dependent on the size of the catchment vs the flow in the river (or volume of the lake), the type, intensity and management of farming, and climatic effects.

Problems commonly arise from animal wastes, especially from cowsheds, holding pens, holding paddocks and yards, and whether the animals have direct access to water. Problems can also arise from septic tanks wastes, and the transport, storage and use of pesticides and fertilisers.

Approaches that can be considered for mitigating these effects include:

- allowing only approved animals
- specifying stocking rates and grass/fodder length
- standards for fencing
- installing riparian strips – specifying size, planting
- adopting approved fertiliser application rates
- using approved fertiliser applicators
- using approved pesticides and application rates
- using approved pesticides applicators
- requiring bunded chemical storage areas

- instituting waste controls and treatment, including dairy shed, offal pits, sheep dips, etc
- introducing holding paddock/yard/pen waste controls (pens include buildings for pigs, chickens, saleyards, etc).

Environment Waikato (2010) reviewed information about the origins of faecal contamination in Waikato waterways and the mitigation options available to address this issue, focussing on rural farmland. Monaghan (2012) looked at the impacts of animal wintering which is increasingly recognised as a critical phase of pastoral farming that has an important influence on animal performance and on contaminant losses from farms to water.

A study of the public health issues associated with stock accessing waterways upstream of drinking water off takes in Australia was reported by the Victorian Department of Health (2011); risks to public health were estimated to be 5 log above tolerable levels. This report includes the statement that the costs of outbreaks overwhelmingly exceed the costs of their prevention. A key finding was that the major source of risk posed by *Cryptosporidium parvum* in typical grazing water supply catchments arises from pre-weaned calves and lambs. Removing calves and lambs from the catchment or housing them in hydrologically isolated areas can reduce the risk by approximately 3 log.

WHO (2012) stated that although there are a large number of zoonotic pathogens that affect humans, five are known to cause illness around the world with high-frequency: *Cryptosporidium*, *Giardia*, *Campylobacter*, *Salmonella* and *E. coli* O157. Efforts to control these pathogens are likely to be effective in controlling other related zoonotic pathogens whether known, as-yet-unrecognised or emergent. Domestic animals such as, poultry, cattle, sheep and pigs generate 85 percent of the world's animal faecal waste, proportionally a far greater amount than the contribution by the human population. The faecal production rate and contribution to the environment of these animals can be as high as  $2.62 \times 10^{13}$  kg/year. Limiting zoonotic pathogen-shedding in farm or production facilities for domestic animals should be accomplished by preventing illness in livestock, through minimising exposure to pathogens, by increasing immunity, by manipulation of the animal gastrointestinal tract microbial ecology and by managing (including treating) animal waste to reduce the release of zoonotic pathogens into the environment.

See DWI (2012) for a discussion on the effect of veterinary medicines on water, where the usage, treatment regimes, metabolism, environmental fate and toxicity of around 450 active ingredients in use in the UK were assessed. Twenty-six substances were identified of potential concern and these were then evaluated using more complex modelling approaches for estimating exposure levels in raw waters and for estimating removal in different drinking water treatment processes. For 14 of the 26 selected priority veterinary medicines, the estimated intakes from conventional or advanced treated water were less than 10 percent of the Acceptable Daily Intake (ADI) for all sections of the population evaluated. It is concluded, therefore, that these 14 veterinary medicines – albendazole, amoxicillin,\* chlortetracycline, chlorsulon,\* cypermethrin, cyromazine, diazinon, enrofloxacin, eprinomectin, lasalocid, salinomycin, tiamulin, trimethoprim and tylosin – are not a potential risk to consumer health. Very minor exceedances of the guide value (equivalent to 10 percent of the ADI) in all populations assessed were found for a further two compounds: halofuginone and tilmicosin.

However, these were not considered to be a potential risk to consumer health. For the remaining 10 compounds (acetylsalicylic acid,\* altrenogest, apramycin, cefapirin, dicyclanil, florfenicol, lincomycin, luprostiol,\* monensin, sulfadiazine), the worst case predicted exposure levels, based on consumption of either raw (environmental) water or conventionally treated water were close to or exceeded ADI values. In some cases the predicted levels of exposure significantly exceeded ADI values. The highest exceedances of ADI values arose from exposure to water sourced from groundwater. There is some evidence that the groundwater model that was used in the study significantly over estimates actual concentrations in the real environment. In the advanced water treatment scenario, worst case predicted exposure estimates only exceeded the ADI value for four compounds (acetylsalicylic acid, florfenicol, lincomycin and luprostiol). All of these ADI exceedances were related to the groundwater scenario. Those marked \* are not on the ACVM Register as at 2012.

MPI (2015) assessed effects of a proposed dam on the Waimea Plains, and MPI (2015a) began to look at ways to protect and restore the Waikato and Waipa Rivers.

## Managing pesticides – an interesting trial

At the request of the UK Government, the Crop Protection Association (CPA) was asked to develop its thoughts on a focused approach towards minimising the environmental impacts of pesticides as an alternative to a proposed pesticide tax. In collaboration with other farming and crop protection organisations, the CPA prepared a five-year programme of voluntary measures. In April 2001, after public consultation, the Government accepted this approach as an alternative way forward, now known as The Voluntary Initiative. Early results in some catchments show up to 60 percent reductions are possible (The Voluntary Initiative 2005). Key measures that have been identified as needing a high level of farmer uptake include:

- Crop Protection Management Plans: a self-assessment which helps farmers review the potential environmental risks associated with crop protection on their farm
- The National Sprayer Testing Scheme: ensures that the spray equipment is correctly maintained and capable of applying the product accurately with no leaking joints or drips
- The National Register of Sprayer Operators: recruited over 20,000 active professional spray operators who are being encouraged through continuous professional development to obtain extra training and information.

## Treatment of dairy farm effluent

Historically, the most common form of treatment for dairy farm effluent has been by a two-pond system combining both an anaerobic and facultative pond (Sukias et al 2001). This method is efficient at removing sediment and biochemical oxygen demand (BOD), but high concentrations of nutrients and pathogens can remain (Hickey et al 1989), often discharging directly to a waterway.

Following the introduction of the Resource Management Act in 1991, land treatment of dairy effluent is now favoured by most regional councils. This approach, relative to the two-pond system, generally results in a marked reduction in the loss of nutrients and

pathogens to waterways. However, excessive levels of these pollutants can still occur. For example, Houlbrooke et al (2004a) reported that 2–20 percent of nitrogen and phosphorus applied to land with dairy effluent is leached directly through the soil profile to enter a water body. Whilst reducing the propensity for surface runoff, artificial subsurface drains are known to transfer both nutrients and pathogens to water bodies (Monaghan and Smith 2004; Ross and Donnison 2003). Pollutant transfer via drainage can occur under both grazed and irrigated systems. Dodd and McDowell (2014) describe land uses that can contribute phosphorus to groundwater, and later cause biological growths when discharging to surface water. Landcare Research has produced a National Map of Phosphorus Leaching, see:

<http://www.landcareresearch.co.nz/science/soils-and-landscapes/ecosystem-services/factsheets>

The success of land treatment of wastes depends strongly upon soil type. For example, Aislabie et al (2001) showed poorly drained gley soils to be much less efficient than allophanic and pumice soils in attenuating bacterial indicators applied in effluent. Generally, soils with a fine structure and absence of macropores are more appropriate for receiving and treating effluent and, faecal material deposited by grazing animals.

Improved timing of effluent application to land, ie, through avoiding irrigation of effluent during wet weather, has been shown to reduce pollutant transfer to waterways (Monaghan and Smith 2004). Deferred irrigation, which involves effluent storage until a suitable soil water deficit arises, has resulted in only 1 percent of applied nutrients reaching subsurface drains (Houlbrooke et al 2004b).

Recent studies using constructed wetlands have shown potential in the treatment of drain flows under grazed dairy pasture, particularly with respect to nutrients (Tanner et al 2005). This approach is also applicable to drainage flows generated by the application of effluent to land.

Advanced pond systems are an alternative to the land application of effluent. These consist of four types of ponds arranged in series (an advanced facultative pond, a high rate pond, algal settling ponds, and a maturation pond) that result in effluent of a considerably higher quality than the traditional two-stage oxidation ponds (Craggs et al 2004).

Several regional councils have been addressing dairy farm effluent issues more proactively in recent years, producing guidelines and best practices documents, eg, Horizons (2008).

## Riparian buffer strips

In addition to subsurface processes, agricultural pollutants can be transferred to waterways by surface runoff generated under rainfall (Houlbrooke et al 2004b; Collins et al 2005). Riparian buffer strips are a potential means of attenuating pollutants carried within surface runoff, with the dense vegetation of the buffer encouraging infiltration of the runoff and deposition of particulates.

The efficiency of riparian buffers varies with topography, soil type and the magnitude of a rain event (Parkyn 2004; Collins et al 2004). In addition, soluble nutrients, clay-sized particles, and free-floating (ie, unattached to soil or faecal material) faecal microbes are less susceptible to deposition and, therefore, are less readily attenuated than particulates.

Riparian management guidelines are available with respect to control of nutrients and sediment (Collier et al 1995) and faecal microbes (Collins et al 2005). Some regional councils are also developing guidelines for their parts of the countryside, eg, Auckland Regional Council (2001), and Environment Canterbury (based on ECan 2003). Also, government departments have issued guidelines for managing waterways on farms (MfE/MAF 2001). A summary of recent research in this area is now available (MAF 2004, MAF 2006a).

The Waterways Centre for Freshwater Management was established in 2009 as a joint partnership between Canterbury and Lincoln Universities. Their website gives links to and produces publications on enhancing water quality in agricultural areas; see <http://waterways.ac.nz>. For example, WET (2014) includes a practical section on riparian management.

Vegetated buffer strips were tested to see if they were effective at removing *Cryptosporidium* during rainfall rates of 15 or 40 mm/h for four hours. Buffers were set on a slope of 5 to 20 percent and soil textures consisted of silty clay, loam, or sandy loam. It was found that vegetated buffer strips consisting of sandy loam or higher soil bulk densities had a 1 to 2 log reduction/m. Buffers consisting of silty clay, loam, or lower bulk densities had a 2 to 3 log reduction/m. Also, it was found that vegetated buffer strip made of similar soils removed at least 99.9 percent of *Cryptosporidium* oocysts from agricultural runoff when slopes were less than or equal to 20 percent and had a length of at least three metres (Atwill et al 2002 – reported in Appendix E of USEPA 2009).

## Natural wetlands

Near-channel saturated areas or wetlands are found extensively in pastoral landscapes in New Zealand. These typically develop where steep hill slopes cause the convergence of surface and subsurface flows, or where an impervious layer exists within the soil profile. Such wetlands have been shown to attenuate nitrate through the process of denitrification, provided that water moves through a wetland slowly enough (Burns and Nguyen 2002; Rutherford and Nguyen 2004).

Modification of wetland drainage through cattle trampling, installation of subsurface drains or artificial channels is, therefore, likely to diminish their pollutant attenuating properties. Cattle are attracted to the smaller, shallower areas of the wetlands for grazing, and excluding stock from them is likely to yield improvements in wetland bacterial water quality (Collins 2004). For guidelines for constructed wetlands treatment systems for dairy farms, see Tanner and Kloosterman (1997).

## Preventing direct deposition to waterways

Faecal contamination of freshwaters arises, where animals have access, through the deposition of faeces directly into waterways. Direct deposition can occur when cattle cross a stream on the way to or from the milking shed (Davies-Colley et al 2004) and through sporadic incursions into the water at access points along the stream bank (Bagshaw 2002). Bridges and the fencing of stream banks are the key mitigation measures for each of these processes, although providing alternative water sources (drinking troughs) can also reduce sporadic incursions, reducing faecal contamination of waterways (Sheffield et al 1997).

Human activity may need to be curtailed too, particularly at impoundments. Water suppliers will need to decide whether to allow swimming, boating and fishing in the impoundment, and how close houses, public toilets and car parks should be to the water.

## Forestry

Land clearing, planting and felling can cause large increases in silt run-off. These activities can be controlled by adopting guidelines such as developed by Environment BOP (2000). BOP Regional Council updated this (BOPRC 2013). ARC (2007) published *Forestry Operations in the Auckland Region: A guideline for erosion and sediment control*. Methods for mitigating fine sediment in coastal areas were addressed in MDC (2015); this report includes references to many other recent New Zealand studies, and a review by Landcare Research staff.

If the headwaters of a catchment used for water supply is in native bush, the water supplier should do everything in its power to ensure that the area remains forested, eg, implementing pest control programmes.

The National Environmental Standards for Plantation Forestry (NES-PF) permit core forestry activities provided there are no significant adverse environmental effects. A new nationally consistent set of regulations will create more certainty (MPI 2017). Rules within regional plans may be more stringent.

Viser (2018) reported on the relationship between harvesting, harvest residues, and the best practices that help mitigate debris flow events and or the delivery of harvest residue in New Zealand.

## 3.5.2 Urban and transportation pollutants

Urban pollution of waterways is primarily caused by contaminants being washed off streets and roofs and flushed through the stormwater drainage system to the receiving water. Contaminants of concern include nutrients, sediment, heavy metals, hydrocarbons, toxic organics and pathogens.



Urban pollutants are associated primarily with particulate material and this offers the potential for contaminant entrapment within, for example, stormwater retention ponds, wetlands, vegetated filter strips and swales, and the addition of filters or screens. Measures such as minimising imperviousness and retaining natural drainage channels will reduce both the source and transport of pollutants.

Sewage can be an intermittent pollutant via leaks or when pumping stations break down and discharge raw sewage to drains (Williamson 1991). Smaller settlements that still use septic tanks should adopt guidelines (and inspections) related to their design, construction, operation, maintenance and cleaning.

Water suppliers with urban communities upstream of their water supply intake should ensure that the appropriate authorities police trade waste bylaws, and consent conditions relating to activities such as landfills and storage of substances likely to have a deleterious effect on the water supply. For example, Sapere (2015) estimated the quantifiable impacts from the 2013 diesel spill into the Raetihi water supply at \$2 million. Trade waste bylaws should require bunding of stored chemicals. The Hazardous Substances and New Organisms Act provides guidelines on storing hazardous substances. The Act has regulations and codes of practice to determine how substances should be transported, stored and used. The storage of hazardous substances must also comply with the New Zealand Building Act and the Resource Management Act.

Spills of hazardous substances during transport have the potential to cause serious problems for water suppliers. Measures that water suppliers may consider include requiring:

- trucking companies/drivers to use approved roads, and follow appropriate standards, for example: NZS 5433:1999 Transport of Dangerous Goods on Land, and The Liquid & Hazardous Waste Code of Practice (NZWWA)
- regional councils to co-ordinate with Fire Service and hazardous substances technical liaison committees re spills, etc
- also see: Stock Effluent from Trucks: Resource Management Guidelines for Local Authorities, Prepared by the Planning Subgroup for The National Stock Effluent Working Group; and the three companion documents:
  - Volume I: Industry Code of Practice for the Minimisation of Stock Effluent Spillage from Trucks on Roads. National Stock Effluent Working Group. April 1999
  - Volume II: A Practical Guide to Providing Facilities for Stock Effluent Disposal from Trucks. National Stock Effluent Working Group. Second edition, March 2003
  - Volume III: Resource Management Guidelines for Local Authorities. March 2003.

### 3.5.3 Petroleum development activities

In 2014 the Ministry for the Environment produced *Managing Environmental Effects of Onshore Petroleum Development Activities (Including Hydraulic Fracturing): Guidelines for Local Government*. This document is a non-statutory guide which provides clarity on the roles of central and local government in managing onshore petroleum development activities (including hydraulic fracturing). These guidelines cover the *whole* life cycle of onshore oil and gas well development, not just hydraulic fracturing.

The potential effects on drinking water supplies need to be managed in accordance with the National Environmental Standard for Sources of Human Drinking Water (discussed in section 5.6.2). Potential risks to drinking water sources are discussed further in section 3.8.4. Drilling muds are covered in section 4.2.2.

A variety of chemicals are used in fluids required for drilling and hydraulic fracturing operations. The environmental effects of these chemicals are primarily related to the transportation, storage and make-up of the hydraulic fracturing fluids before injection, along with managing the flow-back fluids after stimulation of the well. The management of these activities is discussed in sections 5.5 and 5.6. The *Guidelines* include New Zealand case studies. Appendix H lists the chemicals used most often in hydraulic fracturing operations.

The Parliamentary Commissioner for the Environment (PCE 2014) reported on the environmental impacts associated with drilling for oil and gas and analysed the complex system of laws, agencies, and processes that oversee and regulate the industry in New Zealand.

The Australian Department of the Environment (2014) produced a report providing an overview of Australian and international experiences of coal seam gas and coal mining co-produced water and risks to aquatic ecosystems. Table 3 shows the range of concentrations for many determinands found in coal seam gas co-produced water. Table 4 lists the chemicals which may be used in the hydraulic fracturing process. Also in 2014 they produced a report on hydraulic fracturing, and a report on modelling impacts of coal seam gas extraction on groundwater.

Ferrer and Thurman (2015) present a table showing the chemicals found in fracturing fluids and their specific purposes. They also discuss the chemicals that occur naturally in shale waters. This paper includes several informative references.

See also USEPA web site which links many reports:

<http://www2.epa.gov/hydraulicfracturing>. One of these is their report discussing impacts on drinking water resources – see USEPA (2016).

# References

- Addiscott TM, Benjamin N. 2004. Nitrate and human health. *Soil Use and Management* 20: 98–104.
- Aislabie J, Smith JJ, Fraser R, et al. 2001. Leaching of bacterial indicators of faecal contamination through four New Zealand soils. *Australian Journal of Soil Research* 39: 397–406.
- Aller L, Bennett T, Lehr JH, et al. 1987. *DRASTIC: A standardised system for evaluation of ground water pollution potential using hydrogeologic settings*. Washington DC: US Environmental Protection Agency, 130 pp.
- ANSI/AWWA. 2006. *AWWA Standard for Water Wells*. ANSI/AWWA Standard A100–06. Denver CO: American Water Works Association.
- ANSI/AWWA. 2013. *Disinfection of Wells*. ANSI/AWWA Standard C654-13. Denver CO: American Water Works Association.
- ANZECC. 1995. National Water Quality Management Strategy: Guidelines for groundwater protection in Australia. Australian and New Zealand Environment and Conservation Council, Agriculture and Resource Management Council of Australia and New Zealand. 94 pp.  
<http://www.environment.gov.au/water/publications/quality/pubs/nwmqs-groundwater-guidelines.pdf>. These Guidelines are discussed in Assessing the Need to Revise the Guidelines for Groundwater Protection in Australia: A review report 2010, 107 pp. <http://www.ga.gov.au/groundwater/our-capabilities/national-water-quality-management-strategy.html>.
- ANZECC and ARMCANZ. 2000. National Water Quality Management Strategy, Paper No. 4, Australian and New Zealand Guidelines for Fresh and Marine Water Quality, Commonwealth of Australia, Canberra.  
<https://www.environment.gov.au/system/files/resources/53cda9ea-7ec2-49d4-af29-d1dde09e96ef/files/nwqms-guidelines-4-vol1.pdf>.
- Aqualinc. 2011. Impacts of the Canterbury Earthquake on Groundwater Resources. 2 pp.  
<http://aqualinc.co.nz/assets/file/newsletters/Impacts%20of%20The%20Canterbury%20Earthquake%20on%20Groundwater%20Resources.pdf>
- ARC. 2001. *Riparian Zone Management: Strategy for the Auckland region*. Technical Publication 148. Auckland Regional Council.
- ARC. 2007. *Forestry Operations in the Auckland Region: A guideline for erosion and sediment control*. TP223.  
<http://www.aucklandcouncil.govt.nz/EN/planspoliciesprojects/reports/technicalpublications/Pages/technicalpublications201-250.aspx>.
- Atwill ER, Hou L, Karle BM, et al. 2002. Transport of *Cryptosporidium parvum* oocysts through vegetated buffer strips and estimated filtration efficiency. *Appl Environ Microbiol* 68(11): 5517–27.
- Auer MT, Niehaus SL. 1993. Modelling fecal coliform bacteria – I: Field and laboratory determination of loss kinetics. *Water Research* 27: 693–701.

Australian Department of the Environment. 2014. *Co-produced Water: Risks to aquatic ecosystems*. Commonwealth of Australia. 98 pp. [www.iesc.environment.gov.au](http://www.iesc.environment.gov.au).

Australian Department of the Environment. 2014. *Hydraulic Fracturing ('Fracking') Techniques, including Reporting Requirements and Governance Arrangements: Background review*. Commonwealth of Australia. 60 pp. [www.iesc.environment.gov.au](http://www.iesc.environment.gov.au).

Australian Department of the Environment. 2014. *Coal Seam Gas Extraction: Modelling groundwater impacts*. 92 pp. [www.iesc.environment.gov.au](http://www.iesc.environment.gov.au).

AWWA. 1990. *Water Quality and Treatment* (4th edition). Published for American Water Works Association by McGraw-Hill Inc. NOTE: *Water Quality and Treatment: A Handbook on Drinking Water* (6th edition), published 2011, 1696 pp.

AWWA. 2004. *Problem Organisms in Water: Identification and treatment – manual of water supply practices*. AWWA Manual M7. Denver CO: American Water Works Association.

AWWA. 2014. *Groundwater: Manual M21* (4th edition). Denver CO: American Water Works Association. Cat No. 30021-4E, 296 pp.

Bagshaw C. 2002. *Factors Influencing Direct Deposition of Cattle Faecal Material in Riparian Zones*. MAF Technical Paper No. 2002/19. ISBN No: 0-478-07699-1. ISSN No: 1171-4662. 26 pp. See: <http://lshs.tamu.edu/docs/lshs/end-notes/factors%20influencing%20direct%20deposition%20of%20cattle%20fecal%20materi-2944971275/factors%20influencing%20direct%20deposition%20of%20cattle%20fecal%20material%20in%20riparian%20zones.pdf>

BOPRC. 2013. *Erosion and sediment control for forestry operations; Guidelines*. 66 pp. <http://www.boprc.govt.nz/media/293804/erosion-and-sediment-control-guidelines-for-forestry-operations-2013.pdf>.

Burns DA, Nguyen ML. 2002. Nitrate movement and removal along a shallow groundwater flow path in a riparian wetland within a sheep grazed pastoral catchment: results of a tracer study. *New Zealand Journal of Marine and Freshwater Research* 36: 371–85.

Busenberg E, Plummer LN. 2000. Dating young groundwater with sulfur hexafluoride: natural and anthropogenic sources of sulfur hexafluoride. *Water Resources Research* 36(10): 3011–30.

Callander PF, Steffens C, Thomas N, et al. 2014. *E. coli* contamination in “secure” groundwater sourced drinking water supplies. 13 pp. Paper presented at the Water NZ Annual Conference.

Centers for Disease Control and Prevention, Department of Health and Human Services, US Government. [www.bt.cdc.gov/disasters/floods](http://www.bt.cdc.gov/disasters/floods) and select Keep food and water safe and open Disinfecting wells after an emergency. Also: <http://emergency.cdc.gov/disasters/wellsdisinfect.asp> and [http://www.cdc.gov/healthywater/drinking/travel/emergency\\_disinfection.html](http://www.cdc.gov/healthywater/drinking/travel/emergency_disinfection.html).

- Close M, Dann R, Ball A, et al. 2008. Microbial groundwater quality and its health implications for a border-strip irrigated dairy farm catchment, South Island, New Zealand. *J Water Health* 6(1): 83–98.  
<http://jwh.iwaponline.com/content/ppiwajwh/6/1/83.full.pdf>.
- Close ME, Davies-Colley RJ. 1990. Baseflow water chemistry in New Zealand rivers. 1: Characterisation. *New Zealand Journal of Marine and Freshwater Research* 24: 319–41.
- Close ME, Flintoft MJ. 2004. National survey of pesticides in groundwater in New Zealand, 2002. *New Zealand Journal of Marine and Freshwater Research* 38: 289–99.
- Close ME, Stewart M, Rosen M, et al. 2000. *Investigation into Secure Groundwater Supplies*. ESR/IGNS Report No. FW0034, Report to the Ministry of Health, 46 pp.
- Collier KJ, Cooper AB, Davies-Colley RJ. 1995. *Managing Riparian Zones: A contribution to protecting New Zealand's rivers and streams*. Volumes 1 (Concepts) and 2 (Guidelines). Wellington: NIWA/Department of Conservation.
- Collins R. 2004. Fecal contamination of pastoral wetlands. *Journal of Environmental Quality* 33: 1912–18.
- Collins R, Donnison A, Ross C, et al. 2004. Attenuation of effluent-derived faecal microbes in grass buffer strips. *New Zealand Journal of Agricultural Research* 47: 565–74.
- Collins R, Elliott S, Adams R. 2005. Overland flow delivery of faecal bacteria to a headwater pastoral stream. *Journal of Applied Microbiology* 99: 126–32.
- Collins R, McLeod M, Donnison A, et al. 2005. *Surface Runoff and Riparian Management III*. NIWA Client Report 2005-054 to the Ministry of Agriculture and Forestry, Wellington. This document can be accessed from [www.maf.govt.nz](http://www.maf.govt.nz).
- Commonwealth of Australia. 2014. Bore integrity, Background review'. 69 pp.  
<https://www.environment.gov.au/system/files/resources/00f77463-2481-4fe8-934b-9a496dbf3a06/files/background-review-bore-integrity.pdf>.
- Craggs RJ, Sukias JP, Tanner CT, et al. 2004. Advanced pond system for dairy-farm effluent treatment. *New Zealand Journal of Agricultural Research* 47: 449–60.
- Daughney C, Jones A, Baker T, et al. 2006. *A National Protocol for State of the Environment Groundwater Sampling in New Zealand*. GNS Science Miscellaneous Series 5 (cross-referenced as Greater Wellington publication GW/EMI-T-06/249). Wellington: Ministry for the Environment. Available at  
<http://www.mfe.govt.nz/publications/water/national-protocol-groundwater-dec06/index.html>.
- Daughney C, Randall M. 2009. *National Groundwater Quality Indicators Update: State and trends 1995–2008*, GNS Science Consultancy Report 2009/145. 60 pp. Prepared for Ministry for the Environment, Wellington, New Zealand.  
<http://www.mfe.govt.nz/publications/ser/groundwater-quality-trends-2008/>.
- Davies-Colley RJ, Nagels JW. 2002. Effects of dairying on water quality of lowland streams in Westland and Waikato. *New Zealand Grasslands Association* 64: 107–14.

Davies-Colley RJ, Stroud MJ. 1995. *Water Quality Degradation by Pastoral Agriculture in the Whanganui River Catchment*. NIWA Consultancy Report DoC050/1.

Davies-Colley RJ, Nagels JW, Smith AR, et al. 2004. Water quality impact of a dairy cow herd crossing a stream. *New Zealand Journal of Marine and Freshwater Research* 38: 569–76.

Davies-Colley RJ, Wilcock RJ. 2004. Water quality and chemistry in running waters. In J Harding, P Mosley, C Pearson, et al (eds) *Freshwaters of New Zealand*, pp 11.1–11.17. Christchurch: New Zealand Hydrological Society and New Zealand Limnological Society, Caxton Press.

Dodd R, McDowell R. 2014. *Phosphorus Retention and Movement through Stony Soils: Implications of intensive feeding systems and winter forage crops*. AgResearch Report prepared for Hawke's Bay Regional Council and Environment Southland. **RE500/2014/18. 15 pp. [www.envirolink.govt.nz](http://www.envirolink.govt.nz).**

Domenico PA, Schwartz W. 1998. *Physical and Chemical Hydrogeology* (2nd edition). New York: Wiley.

Donnison A, Ross C, Thorrold B. 2004. Impact of land use on the faecal microbial quality of hill-country streams. *New Zealand Journal of Marine and Freshwater Research* 38: 845–55.

Driscoll FG. 1986. *Groundwater and Wells* (2nd edition). Johnson Division, St Paul, Minnesota.

Duncan M, Woods R. 2004. Flow regimes. In J Harding, P Mosley, C Pearson, et al (eds) *Freshwaters of New Zealand*, pp 7.1–7.14. Christchurch: New Zealand Hydrological Society and New Zealand Limnological Society, Caxton Press.

DWI. 2012. *Desk-based Study of Current Knowledge on Veterinary Medicines in Drinking Water and Estimation of Potential Levels*. 258 pp.

**<http://dwi.defra.gov.uk/research/completed-research/2000today.htm>.**

ECan. 1999. *Preliminary Modelling Results Regarding Septic Tank Discharges*. Environment Canterbury report no. U99/83, prepared for the Canterbury Regional Council, by Pattle Delamore Partners Ltd, October.

ECan. 2003. *Riparian Management Classification for Canterbury Streams*. Report No. U03/43, Christchurch: Environment Canterbury.

Environment Canterbury. 2006. *Soil Guideline Values for Protection of Groundwater Quality*. Report No. U06/76. Prepared for Environment Canterbury by Jo-anne E Cavanagh, Landcare Research. 36 pp. July.

**<http://ecan.govt.nz/publications/Pages/contaminated-land.aspx>.**

ECan. 2007. *Predictions of Virus Movement in Canterbury Alluvial Aquifers*. Environment Canterbury Report No. U07/72, 57 pp. Author: Catherine Moore.

Environment BOP. 2013. *Erosion and Sediment Control Guidelines for Forestry Operations*, Bay of Plenty Regional Council, Guideline No. 2012/04, 66 pp. Available at: **<http://www.boprc.govt.nz/media/293804/erosion-and-sediment-control-guidelines-for-forestry-operations-2013.pdf>.**

- Environment Waikato, 2010. *Faecal Contamination of Rural Waikato Waterways Sources, Survival, Transport and Mitigation Opportunities*. Environment Waikato Technical Report 2010/38. Prepared by: Helen Ritchie; and Andrea Donnison (AgResearch). 67 pp.  
<http://www.waikatoregion.govt.nz/PageFiles/19892/TR201038.pdf>.
- ESR. 2010. *Guidelines for Separation Distances Based on Virus Transport Between On-site Domestic Wastewater Systems and Wells*. ESR Client Report No. CSC1001. 296 pp.  
[http://www.envirolink.govt.nz/PageFiles/31/Guidelines\\_for\\_separation\\_distances\\_based\\_on\\_virus\\_transport\\_.pdf](http://www.envirolink.govt.nz/PageFiles/31/Guidelines_for_separation_distances_based_on_virus_transport_.pdf).
- ESR. 2012. *Summary of Literature Impacts of Earthquakes on Groundwater Quality*. 23 pp. Client Report FW12013.
- ESR. 2016. *Modelling of Temperature in Wairau Aquifer*. Prepared for Marlborough District Council; Client Report 16007. Envirolink Report 1623 FW. 37 pp.  
<http://www.envirolink.govt.nz/envirolink-reports/>.
- Ferrer I, Thurman EM. 2015. Chemical constituents and analytical approaches for hydraulic fracturing waters. *Trends in Environmental Analytical Chemistry* 5: 18–25.  
<http://www.sciencedirect.com/science/article/pii/S2214158815000045>.
- Focazio MJ, Reilly TE, Rupert MG, et al. 2002. Assessing groundwater vulnerability to contamination: providing scientifically defensible information for decision makers. *US Geological Survey Circular* 1224, 33 pp.
- Frost F, Frank D, Pierson K, et al. 1993. A seasonal study of arsenic in groundwater, Snohomish County, Washington, USA. *Environmental Geochemistry and Health* 15(4): 209–14. Lovelace Medical Foundation, Albuquerque, NM, USA.
- Hamilton D, Hawes I, Davies-Colley RJ. 2004. Physical and chemical characteristics of lake water. In J Harding, P Mosley, C Pearson, et al (eds) *Freshwaters of New Zealand*, pp 21.1–21.20. Christchurch: New Zealand Hydrological Society and New Zealand Limnological Society, Caxton Press.
- Harding J, Mosley P, Pearson C, et al (eds). 2004. *Freshwaters of New Zealand*. Christchurch: New Zealand Hydrological Society and New Zealand Limnological Society, Caxton Press.
- Heaton THE, Vogel JC. 1981. Excess air in groundwater. *Journal of Hydrology* 50: 201–16.
- Hickey CV, Quinn JM, Davies-Colley RJ. 1989. Effluent characteristics of dairy shed oxidation ponds and their potential impacts on rivers. *New Zealand Journal of Marine and Freshwater Research* 23: 569–84.
- Horizons. 2008. *Best Practice Management of Farm Dairy Effluent in the Manawatu-Wanganui Region*. Prepared for Horizons Regional Council by DJ Houlbrooke, AgResearch. 48 pp. <http://www.envirolink.govt.nz/PageFiles/376/421-hzlc43.pdf>.
- Houlbrooke DJ, Horne DJ, Hedley MJ, et al. 2004b. Minimising surface water pollution resulting from farm-dairy effluent application to mole-pipe drained soils. I: An evaluation of the deferred irrigation system for sustainable land treatment in the Manawatu. *New Zealand Journal of Agricultural Research* 47: 405–15.

Houlbrooke DJ, Horne DJ, Hedley MJ, et al. 2004a. A review of literature on the land treatment of farm-dairy effluent in New Zealand and its impact on water quality. *New Zealand Journal of Agricultural Research* 47: 499–511.

Howard-Williams C. 1987. In-lake control of eutrophication. In WN Vant (ed) *Lake Managers Handbook*, pp 195–202. Water and Soil Miscellaneous Publication No. 103. Wellington: Ministry of Works and Development.

Hutchinson PD. 1990. *Regression Estimation of Low Flows in New Zealand*. Christchurch: Hydrology Centre, DSIR Marine and Freshwater, Department of Scientific and Industrial Research, Publication 22.

Landcare Research. 2016. *Modelling the Source and Fate of Nitrate-Nitrogen Losses from Waimea Plains Land Uses*. Envirolink Advice Grant: 1592-TSDC116. 27 pp. <http://www.envirolink.govt.nz/envirolink-reports/>.

Larned ST, Scarsbrook MR, Snelder TH, et al. 2004. Water quality in low-elevation streams and rivers of New Zealand: recent state and trends in contrasting land-cover classes. *New Zealand Journal of Marine and Freshwater Research* 38: 347–66.

Lundberg JO, Weitzberg E, Cole JA, et al. 2004. Opinion – Nitrate, bacteria and human health. *Nature Reviews Microbiology* 2: 593–602.

McBride GB, Till D, Ryan T, et al. 2002. *Freshwater Microbiology Research Programme: Pathogen occurrence and human health risk assessment analysis*. Wellington: Ministry for the Environment Technical Publication.

MAF. 2004. *Review of Riparian Buffer Zone Effectiveness*. MAF Technical Paper No. 2004/05 prepared by Dr Stephanie Parkin, NIWA. Available at <http://www.crc.govt.nz/publications/Consent%20Notifications/upper-waitaki-submitter-evidence-maf-technical-paper-review-riparian-buffer-zone-effectiveness.pdf>.

MAF. 2006. *Agricultural Pesticides in New Zealand Groundwater*. MAF Technical Paper No: 2006/09. Wellington: MAF Information Bureau.

MAF. 2006a. *Pathogen Pathways: Best management practices*. MAF Technical Paper No: 2006/01. <http://maxa.maf.govt.nz/mafnet/publications/techpapers/06-01/>.

McIntosh J. 2007. Phoslock application – Lake Okareka final report. Whakatane, New Zealand, Environment Bay of Plenty, 28 pp (Env. BOP Environment Publication 2007/23). <http://www.boprc.govt.nz/media/34443/TechReports-070101-PhoslockApplicationLakeOkareka.pdf>.

MDC. 2015. Mitigating Fine Sediment from Forestry in Coastal Waters of the Marlborough Sounds. Marlborough District Council Technical Report No: 15-009. 61 pp. Envirolink Report 1626. <http://www.envirolink.govt.nz/PageFiles/1580/1626-MLDC110-Mitigating%20Fine%20Sediment%20from%20Forestry%20in%20Coastal%20Waters%20of%20the%20Marlborough%20Sounds.pdf>.



MfE/MAF. 2001. *Managing Waterways on Farms: A guide to sustainable water and riparian management in rural New Zealand*. Wellington: Ministry for the Environment and Ministry of Agriculture and Forestry (published by the Ministry for the Environment). 212 pp. See <http://www.mfe.govt.nz/publications/water/managing-waterways-jul01/managing-waterways-jul01.pdf> or go to <http://www.mfe.govt.nz/publications/a-to-z.html>.

MfE. 2002. *Lake Managers Handbook; Land-water Interactions*. Prepared for the Ministry for the Environment by NIWA, 78 pp. <http://www.mfe.govt.nz/publications/water/lm-land-water-jun02.pdf>.

Ministry for the Environment. 2005. *Proposed National Environmental Standard for Human Drinking-water Sources: MfE discussion document*. September. It officially came into effect on 20 June 2008.

Ministry for the Environment. 2006. *A National Protocol for State of the Environment Groundwater Sampling in New Zealand*. 56 pp. <http://www.mfe.govt.nz/publications/water/national-protocol-groundwater-dec06/national-protocol-groundwater-dec06-updated.pdf>.

Ministry for the Environment. 2009. *Draft Users' Guide: National Environmental Standard for Sources of Human Drinking Water*. Wellington: Ministry for the Environment. 96 pp. <http://www.mfe.govt.nz/publications/rma/nes-draft-sources-human-drinking-water/draft-nes-sources-human-drinking-water.pdf>. **Note:** Appendix 3 is Resource Management (National Environmental Standards for Sources of Human Drinking Water) Regulations 2007.

Ministry for the Environment. 2014. *Managing Environmental Effects of Onshore Petroleum Development Activities (Including Hydraulic Fracturing): Guidelines for Local Government*. Wellington: Ministry for the Environment. 182 pp. <http://www.mfe.govt.nz/sites/default/files/managing-environmental-effects-of-onshore-petroleum-development-activities-pdf.pdf>.

**Note:** The New Zealand Ministry of Health's Guides for drinking-water supplies can be accessed as Word documents on the Ministry of Health website: <http://www.health.govt.nz/water> then select Publications and search for WSP.

MoH Public Health Risk Management Plan Guide PHRMP Ref. S1.1. *Surface and Groundwater Sources*. Wellington: Ministry of Health.

MoH Public Health Risk Management Plan Guide PHRMP Ref. P1.3. *Groundwater Abstraction: Bores and wells*. Wellington: Ministry of Health.

MoH Public Health Risk Management Plan Guide PHRMP Ref. P1.4. *Groundwater Abstraction: Springs*. Wellington: Ministry of Health.

MoH Public Health Risk Management Plan Guide PHRMP Ref. P4.1. *Pretreatment Processes: Algicide application*. Wellington: Ministry of Health.

MoH Public Health Risk Management Plan Guide PHRMP Ref. P4.2. *Pretreatment Processes – Destratification*. Wellington: Ministry of Health.

MoH Public Health Risk Management Plan Guide PHRMP Ref. P4.2. *Treatment Processes: Pump operation*. Wellington: Ministry of Health.

MoH Public Health Risk Management Plan Guide PHRMP Ref. D2.4. *Distribution System: Backflow prevention*. Wellington: Ministry of Health.

MoH. 2003. *Register of Drinking-water Supplies in New Zealand* (2003 edition). Wellington: Ministry of Health.

MoH. 2005. *Drinking-water Standards for New Zealand 2005*, and the 2008 Revision. Wellington: Ministry of Health.

Monaghan RM, Smith LC. 2004. Minimising surface water pollution resulting from farm-dairy effluent application to mole-pipe drained soils. II: The contribution of preferential flow of effluent to whole-farm pollutant losses in subsurface drainage from a West Otago dairy farm. *New Zealand Journal of Agricultural Research* 47: 417–28.

Monaghan RM. 2012. The impacts of animal wintering on water and soil quality. Report prepared for Environment Southland. Client report number: RE500/2012/029. 49 pp. [www.envirolink.govt.nz](http://www.envirolink.govt.nz).

Moreau M. et al. 2014. *Envirolink Tools Project – Capture Zone Guidelines for New Zealand*, GNS Science Report 2013/56, 52 pp. <http://www.envirolink.govt.nz/Envirolink-tools/>.

Moreau M. et al. 2014a. *Envirolink Tools Project: Capture zone delineation – technical report*, GNS Science Report 2013/57, 98 pp. Also see Capture Zone delineation simple methods spreadsheet. <http://www.envirolink.govt.nz/Envirolink-tools/>.

MPI. 2011. Ammonia from animal excreta. MPI Technical Paper No: 2012/41. 50 pp. <http://www.mpi.govt.nz/news-and-resources/publications>.

MPI. 2015. *Waimea Plains: A freshwater quantity management case study*. Ministry for Primary Industries. 47 pp. <http://www.mpi.govt.nz/news-and-resources/publications>.

MPI. 2015a. *A Tool for Freshwater Nutrient Management in the Waikato – Waipa catchment*. Summary of work by the Waikato Economic Impact Joint Venture. 30 pp. <http://www.mpi.govt.nz/news-and-resources/publications>.

MPI. 2017. National Environmental Standards for Plantation Forestry: Overview of the regulations. <http://www.mfe.govt.nz/publication-search> and for regulations, see <http://www.legislation.govt.nz/regulation/public/2017/0174/latest/whole.html>.

Muirhead RW, Davies-Colley RJ, Donnison AM, et al. 2004. Faecal bacterial yields in artificial flood events: quantifying in-stream stores. *Water Research* 38: 1215–24.

MWD. 1987. *Lake Managers Handbook*. Water and Soil Miscellaneous Publication No. 103. Wellington: Ministry of Works and Development.

Nagels JW, Davies-Colley RJ, Donnison AM, et al. 2002. Faecal contamination over flood events in a pastoral agricultural stream in New Zealand. *Water Science and Technology* 45(12): 45–52.

NICNAS. 2014. Phoslock™. Existing Chemical Secondary Notification Assessment Report NA/899S. Australian Government, Department of Health. National Industrial Chemicals Notification and Assessment Scheme. 130 pp. <http://www.ag.gov.au/cca>.

- NIWA. 2008. *Comparison of Efficacy of Four P-inactivation Agents on Lake Rotorua Sediments*. NIWA Client Report HAM2008-105. 72 pp.  
<https://www.boprc.govt.nz/media/32536/NIWA-080209-NIWAPlockingtrialsLakeRotorua.pdf>.
- NIWA. 2012. *Guidelines for Artificial Lakes: Before construction, maintenance of new lakes and rehabilitation of degraded lakes*. NIWA Client Report No: HAM2011-045. 177 pp. <http://www.envirolink.govt.nz/Envirolink-tools/>.
- Nokes C, Ritchie J. 2002. *Survey of Arsenic in New Zealand Coastal Groundwaters*. FW0264. Report to the Ministry of Health, Wellington.
- Novotny V. 2003. *Water Quality: Diffuse pollution and watershed management*. New York: John Wiley and Sons.
- NUDLC. 2012. *Minimum Construction Requirements for Water Bores in Australia*. Developed by National Uniform Drillers Licensing Committee for the Australian Government National Water Commission. 3rd edition. 146 pp.  
[https://www.water.wa.gov.au/\\_data/assets/pdf\\_file/0005/1796/Minimum-construction-guidelines-for-water-bores-in-Australia-V3.pdf](https://www.water.wa.gov.au/_data/assets/pdf_file/0005/1796/Minimum-construction-guidelines-for-water-bores-in-Australia-V3.pdf).
- NWQMS. 2013. *Guidelines for Groundwater Quality Protection in Australia*. National Water Quality Management Strategy. Australian Government. 81 pp.  
<http://www.agriculture.gov.au/SiteCollectionDocuments/water/nwqms-groundwater-quality-protection-guidelines.pdf>.
- NZS 4411. 2001. *Environmental Standard for Drilling of Soil and Rock*, 20 pp. This Standard is said to be available free for downloading on the Standards New Zealand website <http://www.standards.co.nz/default.htm>.
- NZWWA. 1998. *Wastewater Treatment Plant Database*. Wellington: New Zealand Water and Wastes Association.
- NZWWA. 2006. *Backflow Prevention for Drinking Water Suppliers, Code of Practice*. Wellington: Backflow Special Interest Group, New Zealand Water and Wastes Association. Since revised, see:
- NZWWA. 2013. *Boundary Backflow Prevention for Drinking Water Suppliers*. 41 pp. Wellington: New Zealand Water and Wastes Association. <http://www.waternz.org.nz>.
- Ohio EPA. 2014. *Guidance for Hydrogeologic Sensitivity Assessment*. 49 pp. WQ-21-001. [http://www.epa.ohio.gov/Portals/28/documents/pws/WQ-21-001\\_HSAGuidance.pdf](http://www.epa.ohio.gov/Portals/28/documents/pws/WQ-21-001_HSAGuidance.pdf).
- Pang L. 2009. Microbial removal rates in subsurface media estimated from published studies of field experiments and large intact soil cores. *J Environ Qual* 38(4): 1531–59.
- Parkyn S. 2004. *Review of Riparian Buffer Zone Effectiveness*. MAF technical paper No. 2004/05 ISBN No: 0-478-07823-4. ISSN No: 1171-4662  
<http://www.maf.govt.nz/mafnet/rural-nz/sustainable-resource-use/resource-management/review-riparian-buffer-zone-effectiveness/index.htm> or go through <http://www.mpi.govt.nz/>.
- PCE. 2012. *Water Quality in New Zealand: Understanding the Science*. Parliamentary Commissioner for the Environment, Wellington. 93 pp. [www.pce.parliament.nz](http://www.pce.parliament.nz).

- PCE. 2014. *Drilling for Oil and Gas in New Zealand: Environmental oversight and regulation*. Parliamentary Commissioner for the Environment. Wellington. 102 pp. [www.pce.parliament.nz](http://www.pce.parliament.nz).
- PDP. 2002. *Groundwater Model Audit Guidelines*. Prepared for the Ministry for the Environment by Pattle Delamore Partners Ltd.
- PDP. 2011. New Zealand Guidelines for the Monitoring and Management of Sea Water Intrusion Risk on Groundwater. Envirolink Project 420-NRLC50. 108 pp. <http://www.envirolink.govt.nz/PageFiles/689/420-NLRC50%20Guidelines%20for%20the%20monitoring%20and%20management%20of%20sea%20water%20intrusion%20risks%20on%20groundwater.pdf>.
- Pearson C, Henderson R. 2004. Floods and low flows. In J Harding, P Mosley, C Pearson, et al (eds) *Freshwaters of New Zealand*, pp 10.1–10.16. Christchurch: New Zealand Hydrological Society and New Zealand Limnological Society, Caxton Press.
- Pearson CP. 1998. Changes to New Zealand's national hydrometric network in the 1990s. *Journal of Hydrology (NZ)* 37: 1–17.
- Piper AM. 1944. A graphic procedure in the geochemical interpretation of water analyses. *Transactions, American Geophysical Union* 25: 914–23.
- Plummer LN, Busenberg E, Böhlke JK, et al. 2000. *Chemical and Isotopic Composition of Water from Springs, Wells, and Streams in Parts of Shenandoah National Park, Virginia, and Vicinity, 1995–1999*. US Geological Survey Open-File Report 00-373, 70 pp.
- Plummer LN, Rupert MG, Busenberg E, et al. 2000. Age of irrigation water in ground water from the Eastern Snake River Plain aquifer, South-central Idaho. *Ground Water* 38(2): 264–83.
- Plummer LN, E Busenberg. 2000. Chlorofluorocarbons. In PG Cook, AL Herczeg (eds) *Environmental Tracers in Subsurface Hydrology*. Boston: Kluwer Academic. Chapter 15, pp 441–78.
- Ritchie J. 2004. *Additional Recommendations for the Identification of Priority 2 Chemical Determinands in New Zealand Drinking-water Supplies (1/7/03 – 30/6/04)*. Report FW0479, to the Ministry of Health, Wellington.
- Ross C, Donnison A. 2003. *Campylobacter* and farm dairy effluent irrigation. *New Zealand Journal of Agricultural Research* 46: 255–62.
- Rutherford JC, Nguyen LM. 2004. Nitrate removal in riparian wetlands: Interactions between surface flow and soils. *Journal of Environmental Quality* 33: 1133–43.
- Rutter H. 2018. Potential impacts on groundwater quality caused by earthquake induced vertical permeability enhancement. Paper at Water NZ Annual Conference, 12 pp. [https://www.waternz.org.nz/attachment?action=download&attachment\\_id=3371](https://www.waternz.org.nz/attachment?action=download&attachment_id=3371).
- Sapere. 2015. *Estimating the Costs of the 2013 Raetihi Diesel Spill*. Report prepared for the Ministry of Health by P Davies and D Moore; 37 pp.
- Scarsbrook MR, McBride CG, McBride GB, et al. 2003. Effects of climate variability on rivers: consequences for long term water quality datasets. *Journal of the American Water Resources Association* 39(6): 1435–47, plus erratum in 40(2): 544.

- Schijven JF, Hassanizadeh SM. 2002. Virus removal by soil passage at field scale and ground-water protection of sandy aquifers. *Water Science & Technology* 46(3): 123–9.
- Sheffield RE, Mostaghimi S, Vaughan DH, et al. 1997. Off-stream water sources for grazing cattle as a stream bank stabilization and water quality BMP. *Transactions of the American Society of Agricultural Engineers* 40: 595–604.
- Sinton L. 1984. The macroinvertebrates in a sewage-polluted aquifer. *Hydrobiologia* 119: 161–9.
- Sinton L. 1986. *A Guide to Groundwater Sampling Techniques*. National Water and Soil Conservation Authority, Water and Soil Miscellaneous Publication No. 99.
- Sinton LW. 2001. Microbial contamination of New Zealand's aquifers. In MR Rosen, PA White (eds) *Groundwaters of New Zealand*. Wellington: New Zealand Hydrological Society Inc.
- Slaney D, Weinstein P. 2004. Water and human health. In J Harding, P Mosley, C Pearson, et al (eds) *Freshwaters of New Zealand*, pp 46.1–46.14. Christchurch: New Zealand Hydrological Society and New Zealand Limnological Society, Caxton Press.
- Smith P. 2003. *Waikato River Water Quality Monitoring Programme Data Report 2003*. Hamilton: Environment Waikato Technical Report 2004/10.
- Stewart MK, Morgenstern U. 2001. Age and source of groundwater from isotope tracers. In MR Rosen, PA White (eds) *Groundwaters of New Zealand*. Wellington: NZ Hydrological Society, pp 161–83.
- Stiff HA. 1951. The interpretation of chemical water analyses by means of patterns. *Journal Petroleum Technology* 3(10): sections 1, 2, and 3.
- Sukias JPS, Tanner CC, Davies-Colley RJ, et al. 2001. Algal abundance, organic matter and physico-chemical characteristics of dairy farm facultative ponds: implications for treatment performance. *New Zealand Journal of Agricultural Research* 44: 279–96.
- Sundaram B, Feitz A, Caritat P de, et al. 2009. *Groundwater Sampling and Analysis: A field guide*. Commonwealth of Australia, Geoscience Australia, Record 2009/27, 95 pp. [http://www.ga.gov.au/image\\_cache/GA15501.pdf](http://www.ga.gov.au/image_cache/GA15501.pdf).
- Tanner CC, Kloosterman VC. 1997. *Guidelines for Constructed Wetland Treatment of Farm Dairy Wastewaters in New Zealand*. NIWA Science and Technology Series No. 48, NIWA, Hamilton. Available at <http://www.niwa.co.nz/sites/default/files/import/attachments/st48.pdf>.
- Tanner CC, Nguyen ML, Sukias JPS. 2005. Nutrient removal by a constructed wetland treating subsurface drainage from grazed dairy pasture. *Agriculture, Ecosystems and Environment* 105: 145–62.
- The Voluntary Initiative. 2005. *H<sub>2</sub>OK? Water Catchment Protection*. UK Water Industry Research Ltd and Crop Protection Association. 16 pp. <http://www.water.org.uk/home/policy/publications/archive/pollution/pesticides-report/pesticides-2.pdf> or <http://www.water.org.uk/home/policy/publications/archive/environment/pesticides-report/pesticides-2.pdf>.

- USEPA. 1998. *Biological Indicators of Ground Water-Surface Water Interaction: An update*. EPA 816-R-98-018. USEPA Office of Ground Water and Drinking Water. [http://www.epa.gov/safewater/sourcewater/pubs/guide\\_bioind\\_1998.pdf](http://www.epa.gov/safewater/sourcewater/pubs/guide_bioind_1998.pdf).
- USEPA. 2006. National Primary Drinking Water Regulations: Ground Water Rule. 71 FR 65573; 65573-65660 (88 pages). <https://www.federalregister.gov/documents/2006/11/08/06-8763/national-primary-drinking-water-regulations-ground-water-rule>.
- USEPA. 2008. *Ground Water Rule: Source assessment guidance manual*. EPA 815-R-07-023. 98 pp. [http://www.epa.gov/ogwdw/disinfection/gwr/pdfs/guide\\_gwr\\_sourcewaterassessments.pdf](http://www.epa.gov/ogwdw/disinfection/gwr/pdfs/guide_gwr_sourcewaterassessments.pdf).
- USEPA. 2009. *Long Term 2 Enhanced Surface Water Treatment Rule: Toolbox guidance manual*. Review Draft. EPA-815-R-09-016. Washington: United States Environmental Protection Agency. 375 pp. Final version published April 2010. [http://www.epa.gov/safewater/disinfection/lt2/pdfs/guide\\_lt2\\_toolboxguidance\\_manual.pdf](http://www.epa.gov/safewater/disinfection/lt2/pdfs/guide_lt2_toolboxguidance_manual.pdf) or go through <http://water.epa.gov/lawsregs/rulesregs/sdwa/lt2/compliance.cfm> or <http://water.epa.gov/lawsregs/rulesregs/sdwa/mdbp/index.cfm>.
- USEPA. 2016. *Hydraulic Fracturing for Oil and Gas: Impacts from the hydraulic fracturing water cycle on drinking water resources in the United States*. Office of Research and Development, Washington, DC. EPA/600/R-16/236Fa.
- USGS. 2004. *Guidelines for Evaluating Ground-Water Flow Models: USGS scientific investigations report, 2004-5038*. US Geological Survey. Available at: <http://water.usgs.gov/pubs/sir/2004/5038/>.
- Van der Raaij RW. 2003. Age-dating of New Zealand groundwaters using sulphur hexafluoride. Unpublished, MSc thesis, Victoria University, Wellington.
- Vant WN. 1987. Eutrophication: an overview. In WN Vant (ed) *Lake Managers Handbook*, pp 151–7. Water and Soil Miscellaneous Publication No. 103. Wellington: Ministry of Works and Development.
- Vermont Department of Environmental Conservation. 2005. *An Ounce of Prevention: A groundwater protection handbook for local officials*. 63 pp. Water Supply Division, Vermont Department of Environmental Conservation Agency of Natural Resources, 103 South Main Street, Old Pantry Building, Waterbury, VT 05671-0403. Available on the internet at: <http://www.vermontdrinkingwater.org/GWPRS/VTOuncePrevention2005.pdf> or <http://dec.vermont.gov/sites/dec/files/dwgwp/sourceprot/pdf/ounceofprevention.pdf>.
- Victorian Department of Health. 2011. *Public Health Issues Associated with Stock Accessing Waterways Upstream of Drinking Water Off-takes*. 97 pp. Prepared by Water Futures Pty Ltd. <http://docs.health.vic.gov.au/docs/doc/Public-health-issues-associated-with-stock-accessing-waterways-upstream-of-drinking-water-off-takes>.

- Viser R. 2018. *Best Practices for Reducing Harvest Residues and Mitigating Mobilisation of Harvest Residues in Steepland Plantation Forests*. Enviro Link Contract 1879-GSD152. 53 pp. Prepared for Gisborne Regional Council. [www.envirolink.govt.nz](http://www.envirolink.govt.nz).
- Water UK. 2012. *Catchment Protection*. Technical Guidance Note No. 7. 4 pp. <http://www.water.org.uk/home/policy/publications/archive/drinking-water/principles-of-water-supply-hygiene>.
- WET. 2014. *Sustainable Drain Management in Selwyn-Waihora*. Version 2. 24 pp. Waihora Ellesmere Trust. <http://www.wet.org.nz/wp-content/uploads/2009/10/2014-Managing-your-drains-v2.pdf>.
- WHO. 2003a. *Assessing Microbial Safety of Drinking-water: Improving approaches and methods*. Published on behalf of the World Health Organization and the Organisation for Economic Co-operation and Development, by IWA Publishing, London. Available at: [http://www.who.int/water\\_sanitation\\_health/dwq/9241546301/en/index.html](http://www.who.int/water_sanitation_health/dwq/9241546301/en/index.html).
- WHO. 2003b. *State of the Art Report: Health risks in aquifer recharge using reclaimed water*. SDE/WSH/03.08. Protection and the Human Environment, World Health Organization Geneva and WHO Regional Office for Europe Copenhagen, Denmark. Available at: [http://www.who.int/water\\_sanitation\\_health/wastewater/wsh0308/en/index.html](http://www.who.int/water_sanitation_health/wastewater/wsh0308/en/index.html).
- WHO. 2004. *Guidelines for Drinking-water Quality 2004* (3rd edition). Geneva: World Health Organization. Available at: [www.who.int/water\\_sanitation\\_health/dwq/gdwq3/en/print.html](http://www.who.int/water_sanitation_health/dwq/gdwq3/en/print.html) see also the addenda.
- WHO. 2006. *Protecting Groundwater for Health*. Geneva: World Health Organization. ISBN 92 4 154 668 9. 697 pp. [http://apps.who.int/iris/bitstream/10665/43186/1/9241546689\\_eng.pdf?ua=1](http://apps.who.int/iris/bitstream/10665/43186/1/9241546689_eng.pdf?ua=1) or [http://www.who.int/water\\_sanitation\\_health/publications/protecting\\_groundwater/en/index.html](http://www.who.int/water_sanitation_health/publications/protecting_groundwater/en/index.html).
- WHO. 2011. *Guidelines for Drinking-water Quality 2011* (4th edition). Geneva: World Health Organization. Available at: [http://www.who.int/water\\_sanitation\\_health/publications/2011/dwq\\_guidelines/en/index.html](http://www.who.int/water_sanitation_health/publications/2011/dwq_guidelines/en/index.html).
- WHO. 2011a. WHO technical notes on drinking-water, sanitation and hygiene in emergencies. Technical Note 1: Cleaning and disinfecting wells. 4 pp. Technical Note 2: Cleaning and disinfecting boreholes. 4 pp. [http://www.who.int/water\\_sanitation\\_health/dwq/publications/en/index.html](http://www.who.int/water_sanitation_health/dwq/publications/en/index.html) – Updated 2013: [http://www.who.int/water\\_sanitation\\_health/publications/technotes/en/](http://www.who.int/water_sanitation_health/publications/technotes/en/).
- WHO. 2012. *Animal Waste, Water Quality and Human Health*. A Dufour, J Bartram, R Bos, et al (eds). Published on behalf of the World Health Organization by IWA Publishing, UK. 489 pp. [http://www.who.int/water\\_sanitation\\_health/publications/2012/animal\\_waste/en/](http://www.who.int/water_sanitation_health/publications/2012/animal_waste/en/).

- WHO. 2016. *Protecting Surface Water for Health: Identifying, assessing and managing drinking-water quality risks in surface-water catchments*. Geneva: World Health Organization. 196 pp.  
[http://www.who.int/water\\_sanitation\\_health/publications/pswh/en/](http://www.who.int/water_sanitation_health/publications/pswh/en/).
- WHO. 2017. *Guidelines for Drinking-water Quality: Fourth edition incorporating the first Addendum*. Geneva: World Health Organization. 631 pp.  
[http://www.who.int/water\\_sanitation\\_health/publications/drinking-water-quality-guidelines-4-including-1st-addendum/en/](http://www.who.int/water_sanitation_health/publications/drinking-water-quality-guidelines-4-including-1st-addendum/en/).
- Wilcock RJ, Nagels JW. 2001. Effects of aquatic macrophytes on physico-chemical conditions of three contrasting lowland streams: a consequence of diffuse pollution from agriculture? *Water Science and Technology* 43(5): 163–8.
- Wilcock RJ, Nagels JW, Rodda HJE, et al. 1999. Water quality of a lowland stream in a New Zealand dairy farming catchment. *New Zealand Journal of Marine and Freshwater Research* 33: 683–96.
- Wilcock RJ, Croker GF. 2004. Distribution of carbon between sediment and water in macrophyte dominated lowland streams. *Hydrobiologia* 520: 143–52.
- Wilkinson L, Hill MJP, Birkenbeuel GK. 1992. *SYSTAT*. SYSTAT Inc.
- Williamson B. 1991. *Urban Runoff Data Book: A manual for preliminary evaluation of stormwater impacts*. Water Quality Centre Publication No. 20. ISBN 0-477-02629-X. Hamilton.
- Williamson RB, Hoare RA. 1987. Controlling nutrient loads and predicting resulting lake nutrient concentrations. In WN Vant (ed) *Lake Managers Handbook*, pp 172–82. Water and Soil Miscellaneous Publication No. 103. Wellington: Ministry of Works and Development.
- WQRA. 2011. *HealthStream: Quarterly Public Health Newsletter of Water Quality Research Australia*, June issue. [www.wqra.com.au](http://www.wqra.com.au).
- Zuber A. 1986. On the interpretation of tracer data in variable flow systems. *Journal of Hydrology* 86(1–2): 45–57.
- Zuber A. 1986. Mathematical models for the interpretation of environmental radioisotopes in groundwater systems. In P Fritz, J Ch Fontes (eds) *Handbook of Environmental Isotopic Geochemistry*, Volume. 2, Part B. Amsterdam: Elsevier, 1–59.



# Chapter 4: Selection of water source and treatment

## Contents

|            |  |           |
|------------|--|-----------|
| <b>4.1</b> | <b>Introduction</b>                                    | <b>2</b>  |
| <b>4.2</b> | <b>Identifying potential sources</b>                   | <b>3</b>  |
| 4.2.1      | Quantity, reliability, access                          | 3         |
| <b>4.3</b> | <b>Barriers to the transmission of micro-organisms</b> | <b>7</b>  |
| 4.3.1      | Protection of water catchments                         | 8         |
| 4.3.2      | Storage and pretreatment                               | 10        |
| 4.3.3      | Coagulation and filtration                             | 10        |
| 4.3.4      | Disinfection and inactivation                          | 10        |
| <b>4.4</b> | <b>Evaluating the sources</b>                          | <b>12</b> |
| 4.4.1      | Where to sample  | 12        |
| 4.4.2      | When to sample and how often                           | 14        |
| 4.4.3      | What to sample for                                     | 15        |
| 4.4.4      | Effect of recycling washwater                          | 23        |
| <b>4.5</b> | <b>Selecting appropriate treatment processes</b>       | <b>24</b> |
| 4.5.1      | Intakes  | 24        |
| 4.5.2      | Treatment selection                                    | 25        |
|            | <b>References</b>                                      | <b>31</b> |

## List of tables

|            |   |    |
|------------|---|----|
| Table 4.1: | Source water quality  | 4  |
| Table 4.2: | Performance that can be achieved by effective barriers to contamination   | 9  |
| Table 4.3: | Effect of impoundment on mean concentrations of some determinands during fairly dry summer/autumn periods                         | 13 |
| Table 4.4: | Summary of sources that may provide significant chemical contaminants of concern (COCs) to freshwater environments in New Zealand | 17 |
| Table 4.5: | Prioritising chemical monitoring in drinking-water using limited information  | 19 |
| Table 4.6: | Treatment options for typical low colour source waters  | 29 |
| Table 4.7: | Treatment options for source waters with colour that also needs to be removed   | 29 |
| Table 4.8: | Treatment options for other types of source waters  | 30 |
| Table 4.9: | Options for waters that only require disinfection   | 30 |

## List of figures

|             |   |    |
|-------------|---|----|
| Figure 4.1: | Confidence limits on a 95th percentile estimate | 15 |
| Figure 4.2: | Micro-organism size and treatability            | 28 |

# 4.1 Introduction

Chapter 3: Source Waters discusses general issues relating to the quality of natural fresh water systems, ie, surface water and groundwater, and measures that can be taken to protect or enhance their quality.

In a sense, this chapter converts these natural waters into prospective raw or source waters, ie, water systems that are being considered for processing into drinking-water. It discusses some of the information that is needed in the planning stages of developing a new water supply, and the barriers that can be used to protect public health. The chapter finishes with a summary of some approaches for matching water treatment processes with raw water quality.

A major consideration when designing a water supply scheme is the nature of the source water that is to be used. Questions that arise include:

- is it in reasonable proximity to the area to be supplied?
- will the flow always be sufficient, or will an impoundment be needed?
- is there an indication of the downstream minimum flow requirement?
- how variable is the quality, day-to-day, or seasonally?

- what is the worst water quality the treatment plant will have to cope with?
- if bore water, will it be assessed as secure?
- will the quality of its waters pose special concerns for the efficacy of treatment? For example, might such variations cause non-compliance with the DWSNZ, impairment of desired plant performance? Or excessive treatment costs?
- is the catchment or recharge area vulnerable to contamination (now or in the future), eg, from geothermal areas, mining activities, urban and agricultural pollutants: faecal microbes, sediment, fertilisers and pesticides?
- what management techniques are available to mitigate contamination and how might their efficacy vary with soil type and topography, for example?

Some of the broader aspects are covered in Chapter 3, and those more specifically related to water supply, in this chapter. Rainwater is covered in Chapter 19: Small and Individual Supplies.

Water Services Association of Australia (WSAA 2016) developed *The Catchment Management Investment Standard* for the WRF (USA). This was intended to provide users with a summary of the key steps and practices that need to be completed to develop a robust and evidence based investment in source catchment management activities. It provides a practical tool to conduct screening level evaluations initially, and can facilitate follow-on, in-depth triple bottom line analyses by utilities.

A similar publication was produced by WHO (2016). It covers catchment risk assessment, the various potential hazards, and their control. The link includes excellent editable checklists and tables, imperative for when considering a new source.

## 4.2 Identifying potential sources

### 4.2.1 Quantity, reliability, access

A variety of sources are used for the purpose of water supply, ranging in size from those needed by single households (see Chapter 19) to supplies needed for large cities. Each kind of supply can be characterised according to its raw water quality (Table 4.1) and there are some rules of thumb that can be applied with regard to the necessary levels of treatment for each source-type:

- the widely-accepted minimum treatment for a non-secure bore water is disinfection
- the widely accepted minimum treatment for a surface water source is filtration followed by disinfection. This minimum level should also be applied to a groundwater source that is under the direct influence of surface water, which includes all springs.

**Table 4.1: Source water quality**

| Raw water source  | Microbiological quality           | Chemical quality  | Aesthetic quality   |
|---|-----------------------------------|---|---|
| Roof water  | Sometimes poor                    | Usually good, subject to air, roof and paint contaminants | Soft/corrosive so could contain some metals   |
| Unconfined aquifer                                      | Sometimes poor                    | Can be high in nitrate or ammonium                        | Variable, can be turbid, discoloured, soft/corrosive. Can be high in iron or manganese              |
| Confined aquifer  | Usually very good                 | Usually good. Can be high in carbon dioxide and ammonium  | Variable. Can be hard or soft/corrosive and high in iron or manganese. Usually low turbidity        |
| River or stream. Controlled or few human/animal impacts | Good to poor                      | Usually good  | Usually good but turbid and discoloured under flood conditions                                      |
| River or stream. High human and/or animal impacts       | Poor. Higher protozoal risk       | Often poor  | Good to poor. Turbid and discoloured under flood conditions   |
| Lake/reservoir. Controlled or few human/animal impacts  | Usually good. May contain algae   | Usually good  | Usually good. May have iron and manganese in deep water. May be coloured water from bush catchments |
| Lake/reservoir. High human and/or animal impacts        | Often poor. Higher protozoal risk | Good to poor  | Usually good, may not be good if prone to algae blooms. May have iron/manganese in deep water       |

The treatment required to produce safe drinking-water depends on the raw water source that is used. Some natural purification occurs in surface waters as a result of dilution, storage time, sunlight exposure, and associated physical and biological processes. With groundwater, natural purification may occur by infiltration of rainfall through soil and percolation through underlying porous materials such as sand, gravel and joints or fractures in bedrock. Effective treatment should be provided to ensure safety and consistency in the quality of drinking-water (MoE 2001).

## Rivers and streams

It is critically important when assessing a possible source of water supply to ensure that the resource has an adequate quantity at all times, so that a reliable source of supply is assured. For flowing waters (rivers and streams) it is important to have a good understanding of the flow regime, see Chapter 3: Source Waters, section 3.3) and have a long enough record of stream flows to provide useful summary statistics. This includes mean annual seven-day minimum flow, mean discharge, and mean annual flood, and to generate a flow-duration curve expressing the proportion of time during which the flow of a stream is equal to or greater than given amounts, regardless of chronological order. Flow measurement is discussed in the Hydrologists' Field Manual (DSIR 1988).

Specific discharge, or flow per unit area of catchment ( $L/s/km^2$ ) when multiplied by the catchment area gives a good indication of the mean annual flow. Also of interest are extreme low flows, such as the 20-year seven-day minimum flow, and flood flows. These data are provided by continuous level recording calibrated by field gaugings of the river in question over a sufficient period. In cases where level and flow-gauging

data have not been collected it is possible to estimate flow regimes by applying measured relationships between rainfall and runoff from gauged basins to ungauged basins within the same region (Duncan and Woods 2004). An easier way to get mean flows and mean annual low flows for third and higher order streams throughout New Zealand is to use the River Ecosystem Classification database that is available from the NIWA website for the Freshwater Fish Database (via online services). The NZFFD Assistant software is available for Windows users to download as a compressed zip file.

The regional council should be contacted early in the assessment of a new source to check on water flows (likely minimum flow requirements and the volume available for allocation) and trends in land use patterns.

Rivers used for drinking-water supply are generally accessible to the public as well as having private lands draining to them. This means that water quality is variable and not easily controlled and that such waters are unprotected from illegal activities and major pollution events (eg, spills from tanker accidents, discharges of urban, farm and factory wastes). Monitoring programmes are needed to determine when river sources may be unacceptable for treatment and to determine the quality of influent water prior to treatment. They should provide an understanding of average water quality, changing water quality conditions and the magnitude and frequency of extreme water quality occurrences. Monthly sampling is commonly chosen for river monitoring networks because it provides useful information about average or characteristic water quality, and changes in water quality. Results can be used for trend analysis after sufficient data have been collected (at least five years, or 50–100 data sets) (Ward et al 1990). Some targeted sampling may be needed too, to cover special events such as flood and drought. This may include obtaining analytical results of significant upstream discharges, either by monitoring, or obtaining consent data from the regional council.

## Lakes and reservoirs

The volume of a lake (or reservoir) is the product of its surface area and its average depth. Catchment size and rainfall determine the flow of water into a lake and thereby influence flushing and supply of water. Storage in lakes and reservoirs is usually expressed in terms of lake level that is measured with a permanent and well-surveyed staff gauge, often to within 1 mm (Hoare and Spigel 1987). Assuming that the lake area varies negligibly with level over the operating range, then available lake volume is proportional to level. The level of a lake is thus controlled by the difference between its inflows and outflows, as defined below (Hoare and Spigel 1987):

|   |           |
|---|-----------|
| surface inflow rate:                              | $Q_{in}$  |
| groundwater inflow rate:                          | $G_{in}$  |
| precipitation rate on lake surface per unit area  | $P$       |
| outflow rate from surface outlet:                 | $Q$       |
| outflow rate to groundwater:                      | $G_{out}$ |
| evaporation rate from lake surface per unit area: | $E$       |
| lake area:  | $A$       |
| level:  | $L$       |

in which case:

$$Q_{in} + G_{in} + (PA) = Q + G_{out} + (EA) + AdL/dt$$

$dL/dt$  is the rate of change in water level, with time. One of the advantages of lake storage is that because outflow rate can only increase by means of an increase in lake level, which absorbs a large proportion of the inflow, outflow rate in response to a storm varies much less markedly than the inflow rate. In other words, in-lake storage has a smoothing effect on outflows in response to storm events. The corollary of this is that when lake levels falls below the spill level, outflow ceases.

It is possible to isolate water storage reservoirs from public access or to prohibit activities like swimming and other forms of contact recreation so that water quality is maintained at a high level. In cases where there is some public ownership of catchment land (eg, Hays Creek, Auckland) control of water quality is not as tight and some additional monitoring may be required to detect incidents that adversely affect the capacity for treatment to be effective. Bimonthly sampling is considered an appropriate frequency that will enable trends to be detected in lakes and reservoirs as well as yielding general water quality information (Ward et al 1990).

## Springs and groundwater sources

Supply of groundwater and springs is dependent on surface waters that supply them and there is often a considerable time lag between changes in the supply (quantity) and quality of surface water and the emergent groundwater being used downstream. Hydraulic changes travel through an aquifer as a pressure wave moving much faster than the groundwater and its constituents. This is particularly so for deep aquifers and groundwater such as those used to supply Christchurch, and for spring waters emerging in the Lake Taupo catchment. In order to have a dependable supply it is necessary to understand these relationships between surface water hydrology and the resulting groundwater resource.

Emergent groundwater and springs water may be affected by surface contamination that is some distance removed from the point of supply and thus, may not be apparent. Shallow groundwater is particularly prone to this sort of contamination, where there are intensive land-use activities in the areas that recharge the groundwater or feed springs. Recent conversions to dairy farms in the Waitaki River valley rely on the relatively clean river water from the Waitaki River to flood-irrigate pasture for dairy farming and are causing some deterioration of shallow groundwater in the area through drainage of polluted surface water. Irrigation of freely-draining soils is a well-known mechanism for introducing surface contaminants to shallow groundwater and is thought to be the main mechanism for nitrate contamination in the Waikato and other parts of New Zealand (Selvarajah et al 1994). Recent irrigation trends in Canterbury, with subsequent intensification of agricultural activities, are increasing the risk of groundwater contamination and uncertain effects on the quantities of some groundwater resources (PCE 2004).

Changes in groundwater quality and quantity are much more gradual than for surface waters and, accordingly, quarterly monitoring should be carried out (ie, at three-month intervals) to provide useful information for water quality time-trend analysis when sufficient data has been collected. At a rate of four samples/site/year it will be many years before sufficient information has been collected for trend analysis, with the consequence that degradation of a groundwater may only be detected well after contamination has occurred (Ward et al 1990). Thus, it may be prudent to monitor surface sources of groundwater and their catchments (eg, for major changes in land use), as well. Water quality data for major New Zealand aquifers collected for the National Groundwater Monitoring Programme is available from the Institute of Geological and Nuclear Sciences.

Risk management issues related to new supplies are addressed in the MoH Public Health Risk Management Plan Guide PHRMP Ref: S2: Development of New Supplies.

The Health Act states:

**69X Duties in relation to new water sources**

Before connecting a new source of raw water to the drinking-water supply, a drinking-water supplier must ensure that raw water from that new source, –

- (a) if untreated, will contain no determinands that exceed the maximum acceptable values specified in the drinking-water standards when it is supplied; or
- (b) is, or will be, treated in such a way that it will contain no determinands that exceed the maximum acceptable values specified in those standards when it is supplied.

**69ZZR Offences against sections in this Part**

- (3) Every person commits an offence who contravenes, or permits a contravention of, any of the following:
  - (f) section 69X (duty to test new water sources):
  - (g) section 69ZI (duty to notify medical officer of health of source and quality of raw water).

## 4.3 Barriers to the transmission of micro-organisms

New Zealand waters generally do not contain chemicals that pose a threat to public health when used for drinking-water supplies. The main concern is the risk of disease by the transmission of micro-organisms, see Chapter 5: Microbiological Quality.

Although disinfectants are available that can inactivate nearly all micro-organisms, it has long been an accepted public health concept that the greater the number of barriers employed, the safer the water for drinking.

WHO (2011) stated in section 1.1.2:

Securing the microbial safety of drinking-water supplies is based on the use of multiple barriers, from catchment to consumer, to prevent the contamination of drinking-water or to reduce contamination to levels not injurious to health. Safety is increased if multiple barriers are in place, including protection of water resources, proper selection and operation of a series of treatment steps, and management of distribution systems (piped or otherwise), to maintain and protect treated water quality. The preferred strategy is a management approach that places the primary emphasis on preventing or reducing the entry of pathogens into water sources and reducing reliance on treatment processes for removal of pathogens.

Traditionally, the barriers have included (WHO 2004c):

- protection of source water (water used for drinking-water should originate from the highest quality source possible)
- coagulation, flocculation and sedimentation
- filtration
- disinfection
- protection of the distribution system.

See WHO (2003) for a thorough discussion on the protection of water quality. This book contains the following chapters:

- Chapter 1: Safe drinking water: an ongoing challenge
- Chapter 2: Introducing parameters for the assessment of drinking water quality
- Chapter 3: Assessment of risk
- Chapter 4: Catchment characterisation and source water quality
- Chapter 5: Treatment efficiency
- Chapter 6: Monitoring the quality of drinking-water during storage and distribution
- Chapter 7: Surveillance and investigation of contamination incidents and waterborne outbreaks
- Chapter 8: Analytical methods for microbiological water quality testing.

### 4.3.1 Protection of water catchments

Drinking-water should not contain any micro-organisms capable of causing disease. All micro-organisms can enter water supplies at any stage of the collection and distribution cycle. Any micro-organisms that reach the water source are reduced in number by natural processes such as storage, settlement and natural solar ultraviolet light. If it can be avoided, sources from which drinking-waters are drawn should not receive faecal contamination, which is likely to contain pathogenic micro-organisms.



Natural processes are insufficient to ensure sterile water for public distribution. Production of microbiologically safe water involves an intense programme of protection, treatment and monitoring that is based largely on the improvement of nature's already established processes. A reasonable combination of the following measures should be in place for all modern urban water supplies:

- the original water source should ideally be protected from contamination by human or animal faeces and the catchment should be protected, see Chapter 3: Source Waters, section 3.5.1
- the water can be stored to allow settlement and die-off of micro-organisms.

Table 4.2 indicates the percentage removal of faecal coliform bacteria as a result of the processes indicated. Care must be taken to see percentage removal in context where the actual numbers of bacteria may be up to  $10^6$ /mL. Monitoring for microbiological quality is simply a check that barriers are working and should not be regarded as a replacement for removal of any of the barriers.

**Table 4.2: Performance that can be achieved by effective barriers to contamination**

| Process                                      | Removal of faecal indicator bacteria         | Reference                           |
|--|--|-------------------------------------|
| Protection of catchment                      | Variable                                     | Medema et al (2003); Collins (2005) |
| Artificial impoundments (3–4 weeks' storage) | Variable                                     | Medema et al (2003)                 |
| Coagulation and sedimentation                | 40–90 percent                                | Medema et al (2003)                 |
| Filtration                                   | 99–99.9 percent                              | Stanfield et al (2003) <sup>a</sup> |
| Chemical disinfection <sup>b</sup>           | >99% with sufficient C.t values <sup>c</sup> | Stanfield et al (2003) <sup>a</sup> |
| UV disinfection                              | >99%, depends on dose <sup>d</sup>           | Stanfield et al (1999) <sup>a</sup> |

a) Stanfield et al (2003) state these removals for bacteria.

b) Chlorine/chloramine/chlorine dioxide/ozone.

c) This does not necessarily apply to protozoan cysts.

d) Doses of 400 J/m<sup>2</sup> will reduce vegetative bacteria by 4 to 8 logs (Stanfield et al 1999).

Faecal material from humans and animals is the most likely source of waterborne pathogens. Humans and domestic animals should be excluded from water supply catchments wherever possible, particularly if the water treatment process does not include flocculation, sedimentation, filtration and disinfection. Section 3.3 discusses the control of surface water quality.

Chapter 3: Source Waters discusses mitigation of pollutants and catchment protection in a broader sense, see section 3.5.

## 4.3.2 Storage and pretreatment

Most pathogenic micro-organisms do not survive long in stored water and significant die-off will occur, typically more than 90 percent removal of faecal indicator bacteria after a week or two's storage. See Chapter 12: Pretreatment Processes, section 12.3.2: Off-river Storage for further information, including some information re reduction times for selected micro-organisms. Retention of water in artificial storage systems such as lakes or dams will allow the suspended material (inorganic and organic, including pathogens) to settle as the specific gravity is marginally greater than that of water. In addition, pathogenic micro-organisms do not usually grow outside the host as the optimum growth conditions do not prevail. Competition for nutrients from the normal aquatic flora, predation by native protozoans, and most particularly inactivation by solar ultraviolet radiation, are important pathogen-removing processes.

The removal of solids by settlement helps remove micro-organisms that are adsorbed to the solids. This clarification of water will facilitate solar ultraviolet inactivation and subsequent disinfection. Where it is not possible to store the bulk of water for sufficient time, pre-disinfection can be used as an alternative to storage to reduce numbers of potential pathogens. However, prechlorination of water at this stage requires higher levels of chlorine and may produce hazardous by-products.

## 4.3.3 Coagulation and filtration

Assistance of natural processes by the addition of a chemical coagulant or flocculant to aggregate bacteria and other particles, followed by sedimentation and filtration through graded sand, can remove up to 80–90 percent of suspended solids. Chemicals such as alum, PAC, iron compounds, and polyelectrolytes may be used to promote aggregation of microbes and other suspended particles, see Chapter 13. Further, activated carbon may be used to remove (by adsorption) some taste and odour causing compounds and other organic molecules.

It is essential that the removal of micro-organisms and other particulate matter should be as complete as possible before disinfection such that the need for high disinfectant doses (and the cost of disinfection) is reduced. This will also limit the production of disinfection by-products.

If the colour and turbidity are not high, effective water treatment can be achieved by using filtration without chemical coagulation. Chapter 14 covers diatomaceous earth, slow sand, cartridge, bag and membrane filtration processes.

## 4.3.4 Disinfection and inactivation

Pathogenic micro-organisms in all water supplies need to be disinfected (inactivated) or removed, except in groundwaters that comply with the bacterial requirements in section 4.5 of the DWSNZ. Disinfection processes are discussed in Chapter 15.

Water suppliers must assume that all surface waters contain *E. coli* (which indicates the probability of pathogenic bacteria and viruses being present) and protozoal (oo)cysts, and treat the water accordingly. A discharge that increases the number of *E. coli* may increase the risk to public health but not necessarily increase the cost of disinfection – usually the dose will be the same whether there is 1 *E. coli* per 100 mL, or (say) 1000 per 100 mL. However, a discharge that increases the number of protozoal (oo)cysts in the source water may cause the required number of log credits to increase, and hence the cost of treatment.

Disinfection can and should inactivate all types of pathogenic, indicator and other micro-organisms. However, by definition disinfection does not usually inactivate every last cell (or (oo)cyst, spore or virion) of micro-organisms that are present. Rather disinfection reduces concentrations to acceptable levels for which disease risk is very low (but not zero, Gerba et al 2003). Note that the term inactivate is used to recognise that disinfecting agents do not (usually) destroy micro-organisms completely, but merely render them incapable of infection and growth (Stanfield et al 2003). Microbes are usually still recognisable microscopically after disinfection, despite being inactivated.

The commonest disinfectant used in water supply is still chlorine, as the gas or hypochlorite, but other chemical disinfectants such as chloramine, chlorine dioxide, and ozone are also used (Stanfield et al 2003). Ozone is particularly popular in Europe, apparently because toxic organochlorine byproducts are not produced with this disinfectant, and because many supplies sourced from rivers contain organic substances that can be destroyed by ozone. Ultraviolet radiation (usually by exposure to lamps emitting most energy at 254 nm) is a powerful disinfecting agent, and is becoming increasingly popular in New Zealand and elsewhere, particularly for inactivating protozoa, again in part because organochlorine byproducts are avoided. See Chapter 15. There is increasing interest in natural solar disinfection (SODIS) of water, particularly in developing countries and situations (eg, disaster zones) where infrastructure for water disinfection is unavailable or has been damaged, but sunlight is abundant (eg, McGuigan 1998; WHO 2009, 2011a).

The quality of the water prior to disinfection is important because it can greatly influence the efficiency (and cost) of disinfection (Sobsey 1989). Both organic matter and suspended particles (indexed by turbidity measurement) need to be reduced to low concentrations prior to disinfection. Organic matter will increase the consumption of chemical (oxidising) disinfectants and therefore the cost. Organic matter also strongly absorbs UV radiation, so reducing the effective dose to micro-organisms. Turbidity will reduce the efficiency of both chemical and ultraviolet disinfection. The pH of water is important for the effectiveness of some forms of disinfection, notably that with chlorine.

A number of micro-organisms such as *Cryptosporidium* and *Giardia*, and the cyanobacteria, are resistant to typical chlorination doses and can penetrate some filtration processes.

The maintenance of a satisfactory level of disinfectant throughout the distribution system is often important, allowing the disinfection process to continue beyond the treatment plant, and to protect against any minor accidental contamination, and helps limit regrowth (biofilms). The lack of a residual is often cited as an important disadvantage of using UV irradiation or ozone as the sole disinfectant, which is therefore best suited to smaller water supplies for which reticulation is in good condition with excellent safeguards in place to avoid accidental contamination.

## 4.4 Evaluating the sources

### 4.4.1 Where to sample

This section discusses the evaluation of potential raw water sources, not source water monitoring which is discussed in Chapter 8: Protozoa Compliance, section 8.2, and not sampling techniques which is dealt with in Chapter 17.

A series of sample sites needs to be assessed when evaluating potential new sources. These should become apparent after conducting a sanitary survey of the catchment.

See WHO (2016) and WSAA (2016) for further information.

#### River systems

Samples should be collected from potential intake sites and from tributaries that may impact on water quality in the main stream at or near the intake. If the intake is in the lower reaches, it may be necessary to determine the distance that saline water extends up the river, particularly during periods of low river flow that coincide with spring tides and/or long periods of onshore wind. Also, samples should be taken close to the point at which the intake would be located, and not necessarily in the middle of the river (eg, from a bridge). This is because upstream tributary inflows can hug the riverbanks for some distance downstream (Rutherford 1994), and so a sample taken from midstream will not necessarily be representative of the quality of the water that would be taken. Sampling from each side and the middle will indicate the degree of mixing, which in large rivers and sluggish rivers, may be minimal.

#### Lakes and reservoirs

Samples should be collected at different depths for at least a year to determine whether the water body stratifies, and if it does, to measure the quality of the lower waters.

Ideally a dam should be built a few years before the water treatment plant is designed. This allows the composition of the impounded water to settle down and gives time to assess its treatment needs correctly. The water quality of a stream can be quite different after impoundment, to the extent that different types of treatment may be required or desired.

Otherwise, there may be a similar catchment nearby where the effects of impoundment can be studied, with the hope that it will give an indication of the probable raw water quality.

The changes that can occur when impounding a stream (see Table 4.3 for some typical values) include:

- after heavy rain, suspended solids can rise to very high levels in stream water, and remain high for a day or two. Suspended solids entering a reservoir are diluted, so do not reach the same high levels, but may remain elevated for weeks. If the flood water is much colder than the reservoir water it may plunge to an intermediate depth
- stream phytoplankton are mainly attached to pebbles (epiphytic or benthic). In a reservoir the phytoplankton are free-swimming or floating species (planktonic), and these can reach much higher population densities. Nutrient levels in a reservoir can be higher too, because most nutrients are associated with run-off, which in a stream, passes with the flood flow, but these nutrients may be retained in an impoundment
- natural organic matter (commonly measured as UV absorbance at 254 nm after membrane filtration) leaches from the soil during and after rain. In a stream this mostly passes down with (or very soon after) the fresh or flood. However, much of it is retained in an impoundment
- reservoir surface water temperature in summer can reach several degrees higher than stream water flowing through a bush catchment, and stay warmer during early winter
- summer stratification and deoxygenation usually occur in impoundments, giving rise to elevated concentrations of iron, manganese, ammonia, carbon dioxide and hydrogen sulphide, mainly in the deeper water
- the reservoir water will usually be dirtier for the first few years due to scouring of the cleared slopes, and due to the high deoxygenation rates of the newly flooded bottom sediments.

**Table 4.3: Effect of impoundment on mean concentrations of some determinands during fairly dry summer/autumn periods**

| Determinand, 'typical values'           | Flowing stream | Impounded water (surface) | Impounded water (deeper) |
|---|----------------|---------------------------|--------------------------|
| Temperature, °C                         | 14             | 19                        | 11                       |
| pH                                      | 7.4            | 7.1*                      | 6.2                      |
| Turbidity, NTU                          | 2              | 5                         | 10                       |
| Total phosphorus, mg/L P                | 0.005          | 0.02                      | 0.2                      |
| Iron, mg/L                              | 0.1            | 0.3                       | 10                       |
| Manganese, mg/L                         | 0.01           | 0.05                      | 2                        |
| Silica, mg/L SiO <sub>2</sub>           | 18             | 13                        | 15                       |
| Alkalinity, mg/L CaCO <sub>3</sub>      | 18             | 13                        | 25                       |
| UV abs <sub>254</sub> , 10 mm, filtered | 0.03           | 0.09                      | 0.15                     |
| Colour, Hazen units                     | 5              | 25                        | 30                       |

Based on Ogilvie 1983.

\* Can reach pH 8 during the afternoon if algal content high.

## Groundwater

The well should be pump-tested, screened and developed before making decisions about any water treatment requirements. Samples need to be collected without any aeration, filling the sample bottle carefully to the top, and allowing several bottle volumes to run through so all air is displaced; a BOD bottle with its tapered lid is ideal for tests that are affected by aeration, including the carbon dioxide calculation. Measure the pH as soon as possible. Faulty sampling can cause a groundwater with a pH of 6.5 with 40 mg/L of carbon dioxide to lose all its carbon dioxide and end up with a pH of about 7.4. This will result in the selection of a completely inappropriate treatment process.

There are several good references to sampling techniques for groundwater. A recent book is by Sundaram et al (2009). See Sinton (1986) for an earlier publication.

Deep confined groundwaters usually display a fairly consistent chemical composition, whereas the composition of shallow unconfined groundwaters can vary markedly throughout a year; see Chapter 3: Source Waters, section 3.2.

### 4.4.2 When to sample and how often

An objective of sampling a prospective water source is to discover the degree of contamination that may (a) regularly be present, and (b) occasionally be present.

Sampling should cover at least a year so that seasonal effects and irregular events can be assessed. Water treatment plants usually have to be designed to treat the worst quality raw water. The usual (regular) water quality is discovered best by random sampling in time. However, the sampling programme should be designed to include an assessment of the impact of climatic events such as drought and different rain intensities. That way, any otherwise unforeseen patterns of quality variation may be picked up. See Chapter 9 for discussion related to cyanobacteria.

Land and Water Aotearoa (LAWA) has developed standards for online monitoring of a range of parameters in source waters, eg. turbidity (LAWA 2013), dissolved oxygen, temperature and flow. Online monitoring of UVT would help correctly size UV disinfection systems for supplies not receiving any other treatment.

In order to pick out extremes in data, a productive approach is to seek to estimate 95 percentiles of the water quality variable with reasonable confidence. As a broad generalisation, more than 50 samples are desirable to achieve this. This is shown in Figure 4.1; once one takes beyond about 50 samples, the width of the confidence interval decreases very slowly. For further information, refer to the Appendix in Chapter 1.

**Figure 4.1: Confidence limits on a 95th percentile estimate**

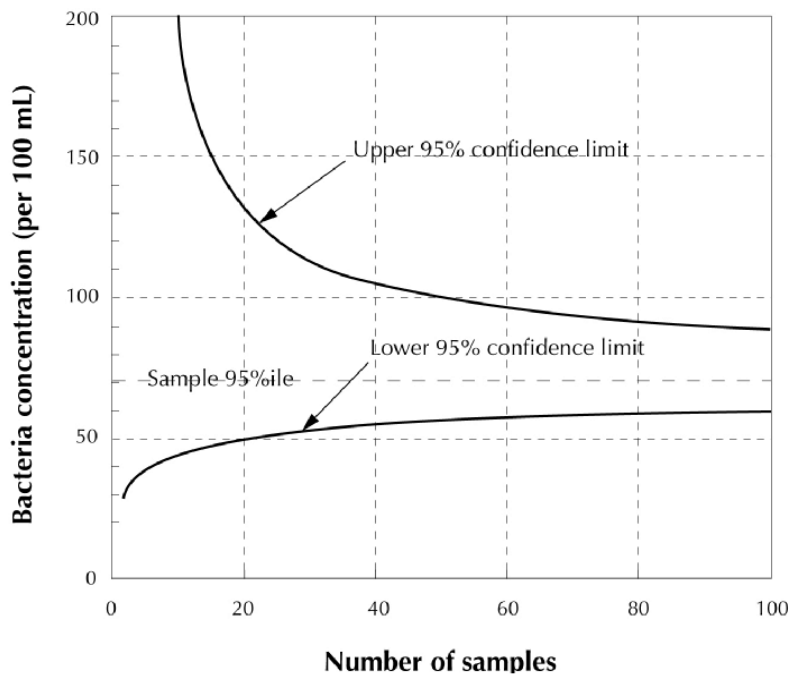

Source: McBride 2005.

### 4.4.3 What to sample for

There are four main reasons for monitoring the quality of the source water:

- 1 it can indicate whether the water will be suitable after treatment for intended uses
- 2 it provides the means of assessing the effectiveness of catchment management
- 3 it can provide an indication of trends or the impacts of events
- 4 it helps water treatment management operate existing plant more effectively.

Regional councils should monitor land use and water quality to fulfil their responsibilities under the RMA 1991. This is both to monitor specific consents to discharges that have been issued, and to assist in the protection and enhancement of the quality of natural waters. The latter is particularly important for non-point discharges of contaminants into the general environment.

A water supplier should monitor all regional council data that are relevant to the source water, including consent applications. It may also be appropriate to commission other water quality monitoring which will assist in the protection of the source.

Until 1995, the Institute of Environmental Science and Research Ltd (ESR) monitored many source waters and drinking-waters on a three- to five-year surveillance cycle for inorganic and physical determinands, pesticides and trace organics under contract to the Ministry of Health. This source water monitoring is now conducted by water suppliers, based on the findings in developing their Water Safety Plans (WSP).

Protozoa monitoring is discussed in Chapter 8: Protozoa Compliance, section 8.2 Source Water. Monitoring other micro-organisms is discussed in section 4.3: Barriers to the transmission of micro-organisms. Generally speaking, unless the water is a secure bore water, all waters contain micro-organisms that will need to be inactivated or removed. The disinfectant dose is normally determined by the disinfectant demand of the water (after treatment), not the number of micro-organisms present. A combination of the two is required for protozoal inactivation.

## Risk-based approach

The DWSNZ include MAVs for 115 chemical determinands that may be present in waters and potentially represent a significant health concern to human consumers. This list contains a wide range of chemicals representing natural and anthropogenic sources, ie, may be found in source waters. A few of them are produced in disinfection processes or could enter the water from treatment chemicals or materials used in the distribution system or plumbing; these are discussed in Chapter 10: Chemical Compliance and Chapter 15: Treatment Processes: Disinfection.

Many of the determinands will not be present in a given water source so procedures are required to prioritise analytical assessments. A risk management approach provides a basis for a decision support framework to prioritise a chemical assessment programme.

The three main criteria for identifying specific determinands of concern to public health in any particular setting are:

- high probability of consumer exposure from drinking-water
- significant hazard to health
- interference in the treatment process.

Chemicals judged to be more likely to occur and to be highly hazardous to human health should be given greater priority for risk management than those judged less likely to occur in the drinking-water and to have lower health hazards. This can be addressed in the WSP.

The period of exposure should also be considered, because health effects caused by chemicals in drinking-water generally result from long-term exposure. Few chemicals in New Zealand drinking-water have been shown to cause acute health problems in the short term, except through intentional or accidental contamination on a large scale. In such instances, the water frequently (but not always) becomes undrinkable due to unacceptable taste, odour or appearance (WHO 2004a).

Risk management strategies for chemicals in drinking-water should also take into account the broader context. For example, if drinking-water is not the main route of exposure for a chemical, then controlling levels in water supplies may have little impact on public health (WHO 2004b).



A recent World Health Organization publication (WHO 2004b) provides guidance on a risk-based approach, and detailed background information on chemical contaminants derived from a wide range of sources. A key component of a risk-based approach is to generate a list of potential contaminants that might be in the source water, based on knowledge about the natural mineralogy, anthropogenic activities and hydraulic processes (eg, rainfall, catchment size, groundwater contribution) operating in the catchment. Integration of this information provides a robust approach to categorising the likely importance of contaminants of concern.

New Zealand has a number of major landscape-scale activities that may contribute significantly to downstream contaminants. Table 4.4 provides an overview of some sources and activities that may give rise to contaminants. This provides a risk-based approach to assess potential contaminants that may occur in a water supply. The objective of this tabulation is to provide an indication of sources that may require greater consideration in New Zealand compared with the generic WHO (2004b) listings. Some of these activities are conducted on a wide scale (eg, pest control for possums, forestry spraying), others may have cumulative risks from a large number of small or diffuse inputs (eg, agricultural ponds), while others may be regional (eg, geothermal, mining).

**Table 4.4: Summary of sources that may provide significant chemical contaminants of concern (COCs) to freshwater environments in New Zealand<sup>1</sup>**

| Source                   | Contaminants of concern  | Comment   |
|--------------------------|--|---|
| Agriculture              | Ammonia, nitrate, modern pesticides, Zn, Cu, F, cyanotoxins, DDT, dieldrin | Cd and F input from fertiliser; Zn from application for facial eczema; Cu from horticultural spraying; DDT and dieldrin from legacy use of pesticides; cyanotoxins from blue-green algal growth in agricultural oxidation ponds |
| Forestry                 | Cu, Cr, As, fungicides, PCP  | Cu from forestry <i>Dothistroma</i> spraying; Cu, Cr, As and PCP from old timber treatment sites  |
| Geothermal               | Hg, B, As, F, Li   | Geothermal (and some hydrothermal) region input to surface and groundwaters   |
| Pest control             | 1080, brodifacoum  | Used widely for possum and rat control  |
| Mining                   | Gold mining: Cu, Cr, As<br>Coal mining: B, Hg, Cd                          | Legacy mining inputs. New Zealand coal is high in B in some areas   |
| Aquaculture              | Hg, antibiotics  | Hg is derived from use of some fish meal. Antibiotics added to many feeds   |
| Domestic oxidation ponds | Ammonia, nitrate, various, cyanotoxins                                     | Microcystin from blue-green algal growth in oxidation ponds   |
| Mineralogy               | As, Hg   | Parts of New Zealand have mineralised areas with natural leaching of As and Hg to receiving waters  |

<sup>1</sup> See also Hickey 1995, 2000; Smith 1986; Lentz et al 1998.

The risk-based procedure then involves listing the potential contaminant contributions followed by the hazard assessment. Table 4.5 illustrates an assessment procedure for an integrated catchment approach. The contaminants illustrated in this table are those likely to be of relevance in the New Zealand environment. There may be a range of site-specific contaminants in some water sources. This approach provides a decision-support basis for monitoring and surveillance of contaminants. The listing process is designed to be relatively exhaustive in drawing information from a range of sources to compile the database. The subsequent procedure involves risk ranking to eliminate contaminants that would not be expected to be present in significant quantities in the catchment. For completeness, Table 4.5 includes determinands that may enter the water during and after treatment.

There is no national database available in New Zealand that provides information on point source and diffuse source contaminants or natural water concentrations. Rather, data must be gathered from a wide range of sources. Information for contaminants from a wide range of discharges is contained in a range of publications (eg, Hickey 1995, 2000; Smith 1986; Lentz et al 1998). Wilcock (1989), Wilcock and Close (1990) reviewed pesticide use, together with a risk-based assessment (Wilcock 1993). The pesticide use data has more recently been updated (Holland and Rahman 1999).

Most New Zealand water suppliers find that they do not need to monitor their source waters for chemical determinands of health significance. Some aesthetic determinands are measured regularly. And some determinands can impair the performance of the treatment process. Generally, the only raw water monitoring recommended to be conducted on site are those determinands that water treatment plant operators can do something about. These depend on the treatment process being used (Chapters 12–15) and the likelihood of them being a nuisance in the treatment process. Some problems that are fairly common are:

- colour (or UV absorbance) and turbidity affect coagulation processes
- natural organic matter and bromide may lead to disinfection by-products
- silt and debris from floods can challenge the solids loading of the treatment plant
- a change in raw water pH can require a pH adjustment either at the coagulation or final stage
- low alkalinity, often during and after heavy rain, may prevent sufficient floc to form in the coagulation process
- free carbon dioxide in bore water can cause metallic corrosion
- iron, and particularly manganese, can be difficult to remove during treatment
- algae can block filters, and cause taste and odour problems
- an increase in the ammonia concentration can increase the chlorine demand
- an increase in the colour or UV absorbance (or decrease in UVT) can affect the UV disinfection efficacy
- low temperatures can affect treatment rates
- C.t values are temperature dependant.

**Table 4.5: Prioritising chemical monitoring in drinking-water using limited information**

| Chemical                                   | Chapter 3  |               | Chapter 4                 |               | Chapter 5         |               | Chapter 6                           |               | Chapter 7  |               | Summary<br>Does this chemical have a significant 'probability of occurrence'?<br>(only ✓ if there are any ✓s in Chapters 3 to 7) | Attenuation<br>Consider attenuation factors. (see Chapter 8). Is it still possible for the consumer to be exposed to this chemical?<br>(only ✓ if yes) | Final list<br>Should this chemical be kept on the list based on practical and feasibility of control considerations?<br>(see Chapter 10)<br>(only ✓ if yes) |  |  |
|--|--|---------------|---------------------------|---------------|-------------------|---------------|-------------------------------------|---------------|--|---------------|--|--|---|--|--|
|  | Is it possible that this chemical is in the raw water source?<br>(only ✓ if yes) |               |                           |               |                   |               |                                     |               |  |               |  |  |   |  |  |
|  | From naturally occurring sources   |               | From agricultural sources |               | From human wastes |               | From human settlements and industry |               | Is it possible that this chemical is introduced during water treatment or distribution?<br>(only ✓ if yes) |               |  |  |   |  |  |
| See datasheets for details                 | Theory   | Site-specific | Theory                    | Site-specific | Theory            | Site-specific | Theory                              | Site-specific | Theory   | Site-specific |  |  |   |  |  |
| <b>Inorganic constituents</b>              |  |               |                           |               |                   |               |                                     |               |  |               |  |  |   |  |  |
| Antimony                                   |  |               |                           |               |                   |               |                                     |               |  |               |  |  |   |  |  |
| Arsenic                                    | ✓  |               |                           |               |                   |               |                                     | ✓             |  |               |  |  |   |  |  |
| Barium                                     |  |               |                           |               |                   |               |                                     |               |  |               |  |  |   |  |  |
| Beryllium                                  |  |               |                           |               |                   |               |                                     |               |  |               |  |  |   |  |  |
| Boron                                      | ✓  |               |                           |               | ✓                 |               |                                     | ✓             |  |               |  |  |   |  |  |
| Cadmium                                    |  |               | ✓                         |               |                   |               |                                     | ✓             |  |               |  |  |   |  |  |
| Chromium                                   |  |               |                           |               |                   |               |                                     | ✓             |  |               |  |  |   |  |  |
| Copper                                     | ✓  |               |                           |               |                   |               |                                     | ✓             |  |               |  |  |   |  |  |
| Cyanide                                    |  |               |                           |               |                   |               |                                     |               |  |               |  |  |   |  |  |
| Fluoride                                   | ✓  |               |                           |               | ✓                 |               |                                     |               | ✓  |               |  |  |   |  |  |
| Lead                                       | ✓  |               |                           |               |                   |               |                                     | ✓             | ✓  |               |  |  |   |  |  |
| Manganese                                  | ✓  |               | ✓                         |               | ✓                 |               |                                     | ✓             | ✓  |               |  |  |   |  |  |
| Mercury (total)                            | ✓  |               |                           |               |                   |               |                                     | ✓             |  |               |  |  |   |  |  |
| Molybdenum                                 |  |               |                           |               |                   |               |                                     |               |  |               |  |  |   |  |  |
| Nickel                                     |  |               |                           |               |                   |               |                                     | ✓             |  |               |  |  |   |  |  |
| Nitrate (as NO <sub>3</sub> <sup>-</sup> ) | ✓  |               | ✓                         |               |                   |               |                                     | ✓             | ✓  |               |  |  |   |  |  |
| Nitrite (as NO <sub>2</sub> <sup>-</sup> ) | ✓  |               |                           |               |                   |               |                                     | ✓             | ✓  |               |  |  |   |  |  |
| Selenium                                   |  |               |                           |               |                   |               |                                     |               |  |               |  |  |   |  |  |
| <b>Organic constituents</b>                |  |               |                           |               |                   |               |                                     |               |  |               |  |  |   |  |  |
| <i>Aromatic hydrocarbons</i>               |  |               |                           |               |                   |               |                                     |               |  |               |  |  |   |  |  |
| Benzene                                    |  |               |                           |               |                   |               |                                     | ✓             |  |               |  |  |   |  |  |
| Toluene                                    |  |               |                           |               |                   |               |                                     | ✓             |  |               |  |  |   |  |  |
| Xylenes                                    |  |               |                           |               |                   |               |                                     | ✓             |  |               |  |  |   |  |  |
| Ethylbenzene                               |  |               |                           |               |                   |               |                                     | ✓             |  |               |  |  |   |  |  |
| Benzo[a]pyrene                             |  |               |                           |               |                   |               |                                     | ✓             |  |               |  |  |   |  |  |

| Chemical  | Chapter 3  |               | Chapter 4                 |               | Chapter 5         |               | Chapter 6                           |               | Chapter 7  |               | Summary<br>Does this chemical have a significant 'probability of occurrence'?<br>(only ✓ if there are any ✓'s in Chapters 3 to 7) | Attenuation<br>Consider attenuation factors. (see Chapter 8). Is it still possible for the consumer to be exposed to this chemical?<br>(only ✓ if yes) | Final list<br>Should this chemical be kept on the list based on practical and feasibility of control considerations?<br>(see Chapter 10)<br>(only ✓ if yes) |  |  |
|---|--|---------------|---------------------------|---------------|-------------------|---------------|-------------------------------------|---------------|--|---------------|---|--|---|--|--|
|   | Is it possible that this chemical is in the raw water source?<br>(only ✓ if yes) |               |                           |               |                   |               |                                     |               |  |               |   |  |   |  |  |
|   | From naturally occurring sources   |               | From agricultural sources |               | From human wastes |               | From human settlements and industry |               | Is it possible that this chemical is introduced during water treatment or distribution?<br>(only ✓ if yes) |               |   |  |   |  |  |
| See datasheets for details                      | Theory   | Site-specific | Theory                    | Site-specific | Theory            | Site-specific | Theory                              | Site-specific | Theory   | Site-specific |   |  |   |  |  |
| <b>Pesticides</b>                               |  |               |                           |               |                   |               |                                     |               |  |               |   |  |   |  |  |
| Alachlor  |  |               | ✓                         |               |                   |               |                                     |               |  |               |   |  |   |  |  |
| Aldicarb  |  |               | ✓                         |               |                   |               |                                     |               |  |               |   |  |   |  |  |
| Aldrin/dieldrin                                 |  |               | ✓                         |               |                   |               |                                     | ✓             |  |               |   |  |   |  |  |
| Atrazine  |  |               |                           |               |                   |               |                                     |               |  |               |   |  |   |  |  |
| Carbofuran                                      |  |               | ✓                         |               |                   |               |                                     |               |  |               |   |  |   |  |  |
| Chlordane                                       |  |               | ✓                         |               |                   |               |                                     |               |  |               |   |  |   |  |  |
| DDT   |  |               | ✓                         |               |                   |               |                                     | ✓             |  |               |   |  |   |  |  |
| 1,2-dibromo                                     |  |               |                           |               |                   |               |                                     |               |  |               |   |  |   |  |  |
| 3-chloropropane                                 |  |               |                           |               |                   |               |                                     |               |  |               |   |  |   |  |  |
| 2,4-D   |  |               | ✓                         |               |                   |               |                                     | ✓             |  |               |   |  |   |  |  |
| Heptachlor and Heptachlor epoxide               |  |               | ✓                         |               |                   |               |                                     |               |  |               |   |  |   |  |  |
| Hexachlorobenzene                               |  |               | ✓                         |               |                   |               |                                     | ✓             |  |               |   |  |   |  |  |
| Lindane   |  |               | ✓                         |               |                   |               |                                     | ✓             |  |               |   |  |   |  |  |
| MCPA  |  |               |                           |               |                   |               |                                     |               |  |               |   |  |   |  |  |
| Pentachlorophenol                               |  |               | ✓                         |               |                   |               |                                     | ✓             |  |               |   |  |   |  |  |
| Permethrin                                      |  |               |                           |               |                   |               |                                     |               |  |               |   |  |   |  |  |
| Propanil  |  |               |                           |               |                   |               |                                     |               |  |               |   |  |   |  |  |
| Pyridate  |  |               |                           |               |                   |               |                                     |               |  |               |   |  |   |  |  |
| Simazine  |  |               |                           |               |                   |               |                                     |               |  |               |   |  |   |  |  |
| Triflurin                                       |  |               |                           |               |                   |               |                                     |               |  |               |   |  |   |  |  |
| Chlorophenoxy herbicides other than 2,4-D, MCPA |  |               | ✓                         |               |                   |               |                                     |               |  |               |   |  |   |  |  |
| 2,4-DB  |  |               |                           |               |                   |               |                                     |               |  |               |   |  |   |  |  |
| Dichlorprop                                     |  |               |                           |               |                   |               |                                     |               |  |               |   |  |   |  |  |
| Fenoprop  |  |               |                           |               |                   |               |                                     |               |  |               |   |  |   |  |  |

| Chemical                        | Chapter 3  |               | Chapter 4                 |               | Chapter 5         |               | Chapter 6                           |               | Chapter 7  |               | Summary<br>Does this chemical have a significant 'probability of occurrence'?<br>(only ✓ if there are any ✓s in Chapters 3 to 7) | Attenuation<br>Consider attenuation factors. (see Chapter 8). Is it still possible for the consumer to be exposed to this chemical?<br>(only ✓ if yes) | Final list<br>Should this chemical be kept on the list based on practical and feasibility of control considerations?<br>(see Chapter 10)<br>(only ✓ if yes) |  |  |
|---------------------------------|--|---------------|---------------------------|---------------|-------------------|---------------|-------------------------------------|---------------|--|---------------|--|--|---|--|--|
|                                 | Is it possible that this chemical is in the raw water source?<br>(only ✓ if yes) |               |                           |               |                   |               |                                     |               |  |               |  |  |   |  |  |
|                                 | From naturally occurring sources   |               | From agricultural sources |               | From human wastes |               | From human settlements and industry |               | Is it possible that this chemical is introduced during water treatment or distribution?<br>(only ✓ if yes) |               |  |  |   |  |  |
| See datasheets for details      | Theory   | Site-specific | Theory                    | Site-specific | Theory            | Site-specific | Theory                              | Site-specific | Theory   | Site-specific |  |  |   |  |  |
| MCPB                            |  |               | ✓                         |               |                   |               |                                     |               |  |               |  |  |   |  |  |
| Mecoprop                        |  |               |                           |               |                   |               |                                     |               |  |               |  |  |   |  |  |
| 2,4,5-T                         |  |               | ✓                         |               |                   |               |                                     |               |  |               |  |  |   |  |  |
| 1080                            |  |               | ✓                         |               |                   |               |                                     |               |  |               |  |  |   |  |  |
| Microcystin                     | ✓  |               | ✓                         |               |                   |               | ✓                                   |               |  |               |  |  |   |  |  |
| <b>Disinfectants</b>            |  |               |                           |               |                   |               |                                     |               |  |               |  |  |   |  |  |
| Monochloramine                  |  |               |                           |               |                   |               |                                     |               | ✓  |               |  |  |   |  |  |
| Di- and trichloramine           |  |               |                           |               |                   |               |                                     |               | ✓  |               |  |  |   |  |  |
| Chlorine                        |  |               |                           |               |                   |               |                                     |               | ✓  |               |  |  |   |  |  |
| Chlorine dioxide                |  |               |                           |               |                   |               |                                     |               | ✓  |               |  |  |   |  |  |
| <b>Disinfectant by-products</b> |  |               |                           |               |                   |               |                                     |               |  |               |  |  |   |  |  |
| Bromate                         |  |               |                           |               |                   |               |                                     |               | ✓  |               |  |  |   |  |  |
| Chlorate                        |  |               |                           |               |                   |               |                                     |               |  |               |  |  |   |  |  |
| Chlorite                        |  |               |                           |               |                   |               |                                     |               |  |               |  |  |   |  |  |
| Chlorophenols                   |  |               |                           |               |                   |               |                                     | ✓             |  |               |  |  |   |  |  |
| 2-chlorophenol                  |  |               |                           |               |                   |               |                                     | ✓             |  |               |  |  |   |  |  |
| 2,4-dichlorophenol              |  |               |                           |               |                   |               |                                     | ✓             |  |               |  |  |   |  |  |
| 2,4,6-trichlorop                |  |               |                           |               |                   |               |                                     |               |  |               |  |  |   |  |  |
| Formaldehyde                    |  |               |                           |               |                   |               |                                     | ✓             |  |               |  |  |   |  |  |
| MX                              |  |               |                           |               |                   |               |                                     |               |  |               |  |  |   |  |  |
| Trihalomethanes                 |  |               |                           |               |                   |               |                                     |               | ✓  |               |  |  |   |  |  |
| Bromoform                       |  |               |                           |               |                   |               |                                     |               | ✓  |               |  |  |   |  |  |
| Dibromochloromethane            |  |               |                           |               |                   |               |                                     |               | ✓  |               |  |  |   |  |  |
| Bromodichloromethane            |  |               |                           |               |                   |               |                                     | ✓             | ✓  |               |  |  |   |  |  |
| Chloroform                      |  |               |                           |               |                   |               |                                     |               | ✓  |               |  |  |   |  |  |

| Chemical   | Chapter 3  |               | Chapter 4                 |               | Chapter 5         |               | Chapter 6                           |               | Chapter 7  |               | Summary<br>Does this chemical have a significant 'probability of occurrence'?<br>(only ✓ if there are any ✓'s in Chapters 3 to 7) | Attenuation<br>Consider attenuation factors. (see Chapter 8). Is it still possible for the consumer to be exposed to this chemical?<br>(only ✓ if yes) | Final list<br>Should this chemical be kept on the list based on practical and feasibility of control considerations?<br>(see Chapter 10)<br>(only ✓ if yes) |  |  |
|--|--|---------------|---------------------------|---------------|-------------------|---------------|-------------------------------------|---------------|--|---------------|---|--|---|--|--|
|  | Is it possible that this chemical is in the raw water source?<br>(only ✓ if yes) |               |                           |               |                   |               |                                     |               |  |               |   |  |   |  |  |
|  | From naturally occurring sources   |               | From agricultural sources |               | From human wastes |               | From human settlements and industry |               | Is it possible that this chemical is introduced during water treatment or distribution?<br>(only ✓ if yes) |               |   |  |   |  |  |
| See datasheets for details                                 | Theory   | Site-specific | Theory                    | Site-specific | Theory            | Site-specific | Theory                              | Site-specific | Theory   | Site-specific |   |  |   |  |  |
| <b>Chemicals that may give rise to consumer complaints</b> |  |               |                           |               |                   |               |                                     |               |  |               |   |  |   |  |  |
| <i>Inorganic constituents</i>                              |  |               |                           |               |                   |               |                                     |               |  |               |   |  |   |  |  |
| Aluminium  |  |               |                           |               |                   |               |                                     |               |  | ✓             |   |  |   |  |  |
| Ammonia  | ✓  |               | ✓                         |               | ✓                 |               | ✓                                   |               | ✓  | ✓             |   |  |   |  |  |
| Chloride   | ✓  |               |                           |               |                   |               | ✓                                   |               | ✓  | ✓             |   |  |   |  |  |
| Copper   | ✓  |               |                           |               |                   |               | ✓                                   |               | ✓  | ✓             |   |  |   |  |  |
| Hydrogen sulphide  | ✓  |               | ✓                         |               |                   |               |                                     |               |  |               |   |  |   |  |  |
| Iron   | ✓  |               | ✓                         |               | ✓                 |               | ✓                                   |               | ✓  | ✓             |   |  |   |  |  |
| Manganese  | ✓  |               | ✓                         |               | ✓                 |               | ✓                                   |               | ✓  | ✓             |   |  |   |  |  |
| Sodium   | ✓  |               | ✓                         |               | ✓                 |               |                                     |               | ✓  | ✓             |   |  |   |  |  |
| Sulphate   | ✓  |               | ✓                         |               | ✓                 |               |                                     |               | ✓  | ✓             |   |  |   |  |  |
| Zinc   | ✓  |               | ✓                         |               |                   |               |                                     |               | ✓  | ✓             |   |  |   |  |  |
| <i>Organic constituents</i>                                |  |               |                           |               |                   |               |                                     |               |  |               |   |  |   |  |  |
| Synthetic detergents                                       |  |               |                           |               | ✓                 |               | ✓                                   |               |  |               |   |  |   |  |  |
| <i>Disinfectants and disinfectant by-products</i>          |  |               |                           |               |                   |               |                                     |               |  |               |   |  |   |  |  |
| Chlorine   |  |               |                           |               |                   |               | ✓                                   |               | ✓  | ✓             |   |  |   |  |  |
| Chloramine   |  |               |                           |               |                   |               | ✓                                   |               | ✓  | ✓             |   |  |   |  |  |
| 2-chlorophenol   |  |               |                           |               |                   |               | ✓                                   |               |  |               |   |  |   |  |  |
| 2,4-dichlorophenol   |  |               |                           |               |                   |               | ✓                                   |               |  |               |   |  |   |  |  |
| 2,4,6-trichlorophenol                                      |  |               |                           |               |                   |               | ✓                                   |               |  |               |   |  |   |  |  |
| <i>Chemicals not of health significance</i>                |  |               |                           |               |                   |               |                                     |               |  |               |   |  |   |  |  |
| Asbestos   |  |               |                           |               |                   |               | ✓                                   |               | ✓  | ✓             |   |  |   |  |  |

Source: Derived from WHO 2004b.

Upgrade this table following the WHO protocol – see Figure 1 (WHO 2004b).

## 4.4.4 Effect of recycling washwater

The effect of recycling wastewater from the sedimentation process and filter backwash can modify the composition of the source water, especially if the return is not continuous, so care is needed when collecting raw water samples, ie, the raw water is really source water plus recycle. Sedimentation tank wastes are usually thickened and dewatered, with only the supernatant being returned. These practices can save 1–4 percent of the flow.

The recycled water may contain high pathogen densities (the main concern being pathogenic protozoa) that challenge the filter and result in breakthrough unless certain precautions are taken. The USEPA found of the 12 waterborne cryptosporidiosis outbreaks that have occurred at drinking water systems since 1984, three were linked to contaminated drinking-water from water utilities where recycle practices were identified as a possible cause. This resulted in their Filter Backwash Recycle Rule (USEPA 2002).

Section 5.2.1.3 of the DWSNZ outlines the recycling conditions that need to be followed in order avoid an increase in the protozoal log removal requirement.

The UKWIR (2000) developed a water treatment guidance manual that addresses recycling of spent filter backwash water. The UKWIR recognised the risk posed by concentrated suspensions of *Cryptosporidium* oocysts in spent filter backwash. UKWIR developed the following guidelines to prevent passing oocysts into finished water:

- backwash water should be settled to achieve a treatment objective of greater than 90 percent solids removal before recycling
- recycle flows should be at less than 10 percent of raw water flow and continuous rather than intermittent
- continuous monitoring of the recycle stream with online turbidimeters should be conducted
- jar tests should be conducted on plant influent containing both recycle streams and raw water to properly determine coagulant demand
- polymers should be considered to assist coagulation if high floc shear or poor settling occurs
- the recycle of liquids from dewatering processes should be minimised, particularly when quality is unsuitable for recycling.

Raw waters with a high natural organic matter content may cause recycling problems due to formation of increased levels of disinfection by-products. Trihalomethane formation potential products can increase by over 100-fold between the raw water and recycled water.

Another potential health concern, particularly if water from sludge treatment systems is returned, is the possibly high level of monomer resulting from the use of polyelectrolyte. Section 8.2.1.2 of the DWSNZ shows how to address this problem.

Risk management issues related to recycling are covered in the MoH Public Health Risk Management Plan Guide PHRMP Ref: P4.4: Pre-treatment Processes – Waste Liquor Reintroduction.

## 4.5 Selecting appropriate treatment processes

### 4.5.1 Intakes

The intake or point of abstraction of a drinking-water supply may be from a bore, spring, infiltration gallery, lake, reservoir, stream, or river. Careful design and maintenance of the abstraction process can prevent significant problems in subsequent treatment processes. Design issues include the adequate testing and development of bores, provision for backflushing infiltration galleries, the use of fine screens to prevent particulate materials entering the process, and the use of presettling processes to keep silts and sands out of pumps and filters and, where required, for avoidance of the use of high turbidity water after storms. The degree of any pretreatment needed will depend on the subsequent treatment processes. Pretreatment processes are discussed in Chapter 12.

Design of bore abstraction systems should consider potential yields and how to enhance these; changes in water quality with time; the potential for easy removal of the pump, and possibly the screen, for maintenance and cleaning and inspection of the casing.

Specifications for well drilling work should ensure that rigs and equipment are thoroughly steam cleaned between jobs to minimise the potential for transfer of iron and manganese fixing bacteria between different locations. If infestations of these bacteria occur, regular treatment of the bore with acid and chlorine washes may control the problem. Specifications should also include the logging of the drillings, and the supply of the bore logs to the water supplier. See Chapter 3: Source Waters, section 3.2 Groundwater for further information.

River intakes must be sited so that they:

- are above the minimum water level (a weir may need to be constructed on small rivers)
- do not accumulate debris
- do not block with gravel
- are not on fish migratory paths
- are preferably upstream of or on the opposite bank from discharges, spills or dirty tributaries
- and if that is not possible, they are far enough downstream for the discharge to be fully mixed.



There must be adequate redundancy of intake pumps to guard against the event of breakdowns, and must be sited above maximum flood level. Failure to supply water to the plant inlet can have serious repercussions on the treatment plant and is crucial to the whole supply system.

Valve selection for reservoirs is important. The top valve must be high enough to draw the required flow of upper (epilimnion) water while the water level is nearly full. A lower valve is needed so oxygenated water can still be abstracted during dry or high use periods; this means high dams may require several valves. If there is an insufficient number of valves, anaerobic water may have to be abstracted when the water level is too low for the top valve to operate. Anaerobic water can contain very high concentrations of iron and manganese. Anaerobic water can also have elevated ammonia and sulphide levels, which may challenge the chlorination equipment.

Risk management issues related to intakes are addressed in:

- MoH Public Health Risk Management Plan Guide PHRMP Ref: P1.1: Surface Water Abstraction – Rivers, Streams and Infiltration Galleries, and in
- MoH Public Health Risk Management Plan Guide PHRMP Ref: P1.2: Surface Water Abstraction – Lakes and Reservoirs.

## 4.5.2 Treatment selection

### General

For any particular source water, there will usually be several treatment options that can produce drinking-water that complies with the DWSNZ. What is successful overseas may not always be appropriate for New Zealand. The treatment process is selected after assessing the catchment and its water quality; see previous sections of this Chapter and Chapter 3: Source Waters. Procedures for handling quality issues not addressed by the treatment process should be covered in the WSP.

New Zealand surface water sources are often influenced by the steep topography of the land, both in terms of quantity and quality, and the short in-river travel distances. Overlaying this are sudden weather changes with significant rainfall. Unstable catchments can result in rapid changes in turbidity or solids loadings in the source water, often with equally rapid clearing of these conditions. Most of New Zealand is not subject to prolonged drought, freezing or spring snowmelt.

Community populations in New Zealand are somewhat different from those in more densely populated countries. Our relatively small population and large per capita land area means that our water supplies are often widely spaced, serving small or very small populations. A lot of the overseas technical papers and studies tend to deal with the larger plants. Often these are not relevant to most of our water suppliers. In New Zealand there are:

- 14 communities providing drinking-water to >50,000 people
- 58 communities providing drinking-water to 5000–50,000
- 213 communities providing drinking-water to 500–5,000
- 1,702 communities providing drinking-water to <500.

Over 96 percent of New Zealand communities have a population of less than 5,000. Our large communities are not large by overseas standards. Drinking-water for populations less than 500 is discussed further in Chapter 19: Small, Individual and Tankered Supplies.

Information regarding protection of catchments, pre-treatment, and storage is covered in more detail in section 4.3. Other data can often be obtained from regional councils or locally in terms of water levels or flows, and past flood events.

The information and data required by the design or process engineer to help identify and select treatment plant components and configurations are discussed in section 4.2: Identifying potential sources, ie, potential water quantity, reliability and continuity, and from section 4.4: Evaluating the sources.

## Pre-selection process

The traditional approach to treatment plant design includes obtaining:

- hydrological data
- rainfall and other relevant climate data
- historical raw water quality
- a good indication of the worst raw water quality expected
- information about land use that can affect water quality (sanitary survey)
- results of monitoring water treatment in the same or similar catchments
- assessment of potential water treatment processes.

Ideally the pre-selection and planning process will allow time for pilot plant studies to test the preferred treatment processes, allowing cost reductions in the final plant by not having to incorporate as many contingencies in the design. Some advantages in including a pilot plant stage were discussed in Couper and Fullerton (1995).

Other planning issues that must be considered are:

- expected design life
- intake site selection
- population projections, ie, proposed and future plant capacity
- long term (or other) security of the catchment or water source
- planning and resource allocation/management issues, including plant waste disposal.

Due to rapid changes or extremes in raw water quality some water supplies use more than one source. Examples include Gisborne (upland sources and Waipaoa River), and Wellington's Kaitoke supply (river water or pond storage). This offers the option to switch from a source that becomes difficult to treat, to a cleaner source, either fully or by mixing the two. Two sources may be needed when the main source is affected by drought or when the abstraction rate is controlled by an in-stream minimum flow, eg, Waikanae.

If the difficult treatment situations are expected to be short-lived, there may be advantages in relying on increasing the volume of stored treated water.

## Selection options

Figure 4.2 shows the size of some micro-organisms and the suitability of various treatment processes for removing them. The size of viruses and small bacteria show why disinfection is so important.

As well as the traditional assessment of the source water and catchment, the DWSNZ now require some water supplies to monitor *Cryptosporidium*, in order to determine the source water protozoal risk category, refer section 5.2.1 of DWSNZ, and Chapter 8: Protozoa Compliance, section 8.2 of the Guidelines.

Chapter 8: Protozoa Compliance, section 8.3 discusses the cumulative log credit approach to the removal or inactivation of protozoa, and discusses the log credits that different treatment processes can be awarded. This is illustrated with some examples, showing different approaches for achieving 3 and 4 log removals.

As well as source water quality, costs have a major bearing on the choice of treatment process. Processes such as diatomaceous earth, bag and cartridge filtration usually require less capital to install than coagulation/filtration plant and membrane filtration so tend to be used more often in the smaller water supplies. Conventional coagulation/filtration plants usually have lower operating costs so tend to be used by the larger water suppliers. Costs are not discussed in these Guidelines.

The treatment processes chosen for protozoal compliance must also be suitable for dealing with other impurities, as covered in the following discussion. Generally, for most source waters, the water treatment process is still selected on basic issues such as colour and turbidity. Whether a source water needs 3 or 4 log removals for protozoal compliance, usually dictates the selection of disinfectant or its dose, or the turbidity required from the filters. If a source water is required to achieve 4 log removals, it may be necessary to include an additional treatment process, over and above the amount of treatment that just colour and turbidity would require.

**Figure 4.2: Micro-organism size and treatability**

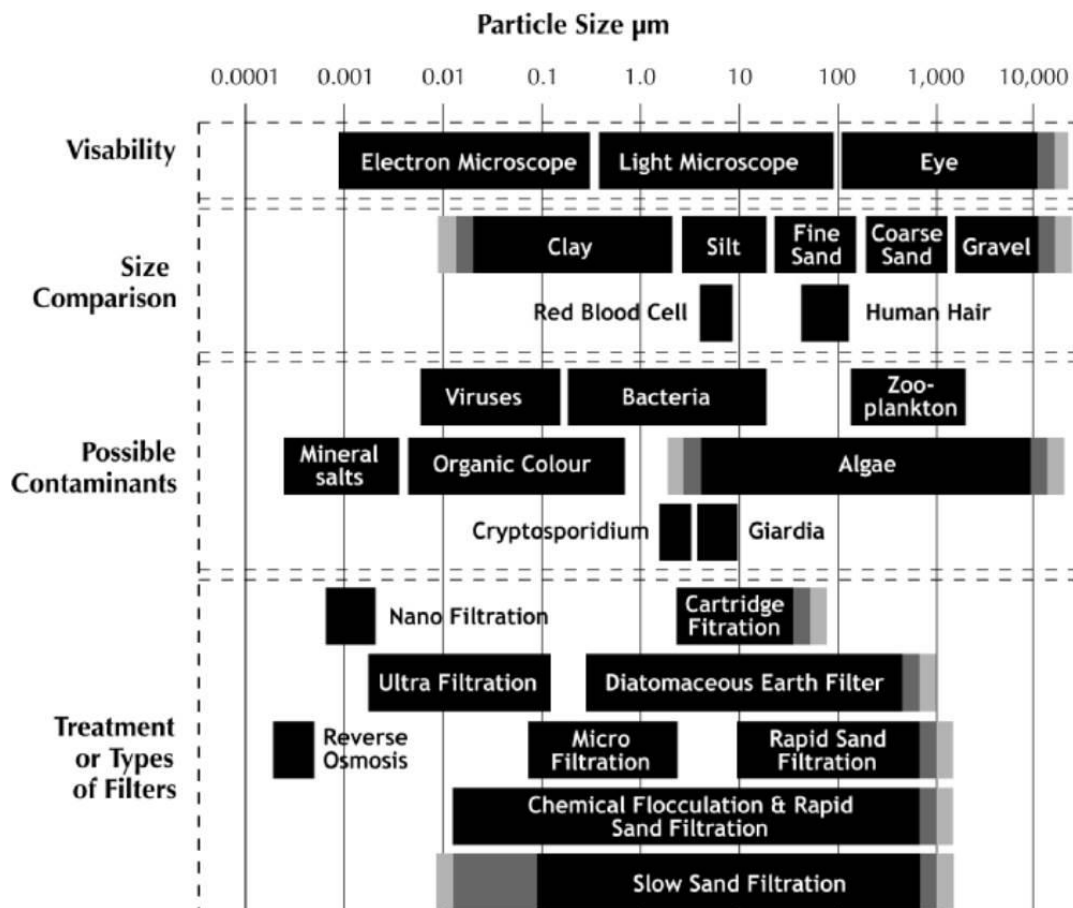

This section concentrates on the options for the treatment of determinands other than protozoa. Chapter 8 discusses the treatment requirements needed in order to comply with protozoa compliance. Chapters 12–15 describe operational aspects of the treatment processes in more detail. Chapter 3 in AWWA (1990) gives a guide to the selection of water treatment processes.

All water sources other than secure bore water need some form of disinfection. Chlorine is still the most frequently used disinfectant in New Zealand water supplies. At reasonable doses, it is effective against most bacteria and viruses. The selection of disinfectant will be dependent on the approach adopted in order to satisfy protozoa compliance, and whether it has been decided to maintain a chlorine residual in the distribution system. See Chapter 15: Disinfection, Table 15.3 for a summary of the efficacy of different disinfectants.

Tables 4.6–4.8 only offer guidance; they are not meant to be part of a design manual. The tables attempt to match potential treatment processes with raw water quality. In some cases the raw water quality may be such that a combination of processes is needed.

For individual supplies, refer to Chapter 19, Table 19.2: Contaminants and treatment methods, and Table 19.3: Point-of-use devices and their effectiveness against various contaminants.

**Table 4.6: Treatment options for typical low colour source waters**

| Treatment options                          | Filtering non-secure bore water | Removing carbon dioxide from bore water | Removing iron or manganese ex bore water | Filtering surface water without much colour (note 3) |
|--|---------------------------------|---|--|--|
| Cartridge                                  | Yes                             |   |  | Yes  |
| Aeration                                   |                                 | Yes (note 1)                            | Yes (note 2)                             |  |
| Aeration, coagulation and filtration       |                                 |   | Yes                                      | Yes  |
| Aeration plus oxidation and/or pH increase |                                 | Yes                                     | Yes                                      |  |
| Diatomaceous earth filtration              | Yes                             |   |  | Yes  |
| Slow sand filter                           |                                 |   |  | Yes  |
| Membrane filtration (MF)                   |                                 |   |  | Yes  |

1 Check that sodium hydroxide or hydrated lime is not needed too.

2 Check amount of iron and manganese removed by aeration alone: oxidation and/or pH adjustment may be needed.

3 If the turbidity is low enough, disinfection may be the only treatment needed. Ozone may lower the colour.

**Table 4.7: Treatment options for source waters with colour that also needs to be removed**

| Treatment options                       | Surface water with low particulate matter | Waters with high or a large range of turbidities | Surface water with large numbers of algae (note 1) | Lowland rivers below industry or intense agriculture |
|---|---|--|--|--|
| Slow sand filter                        | Yes                                       |  |  |  |
| Coagulation, direct filtration          | Yes                                       |  |  |  |
| Coagulation, sedimentation, filtration  |   | Yes  | Yes  | Yes (note 2)   |
| Coagulation, DAF, filtration            |   | Yes  | Yes  | Yes (note 2)   |
| Coagulation preceded by microstrainer   |   |  | Yes  |  |
| Membrane filtration (MF)                | Yes                                       | Yes (note 3)                                     | Yes (note 3)                                       | Yes (note 3)   |
| Coagulation or MF plus activated carbon |   |  | Yes  | Yes  |
| Coagulation or MF plus ozone            |   |  |  | Yes  |

1 There could be seasonal variation.

2 Pretreatment may be essential, eg, bankside or off-river storage.

3 Coagulation may be needed at times.

**Table 4.8: Treatment options for other types of source waters**

| Treatment options                          | Groundwater with high ammonia concentrate | Groundwater with geothermal material | Waters with low colour but glacial flour | Hard water |
|--|---|--------------------------------------|--|------------|
| Aeration                                   | At high pH                                |                                      |  |            |
| Aeration plus oxidation and/or pH increase | Yes                                       | Possibly                             |  |            |
| Diatomaceous earth filtration              |   |                                      | Possibly                                 |            |
| Slow sand filter                           |   |                                      | Possibly                                 |            |
| Membrane filtration (MF)                   |   |                                      | Yes                                      |            |
| Coagulation and sand filtration            |   | Possibly                             | Yes                                      |            |
| Softening                                  |   | Possibly                             |  | Yes        |

Note: Groundwaters containing geothermal water may need specific guidance.

**Table 4.9: Options for waters that only require disinfection**

| Disinfectant     | Bacterial compliance | Protozoal compliance | Residual in the distribution system |
|------------------|----------------------|----------------------|-------------------------------------|
| Chlorine         | Yes                  |                      | Yes                                 |
| Chloramine       | Yes                  |                      | Yes                                 |
| Chlorine dioxide | Yes                  | Yes                  | Yes                                 |
| Ozone            | Yes                  | Yes                  |                                     |
| UV light         | Yes                  | Yes                  |                                     |

Notes

- Nanofiltration and reverse osmosis systems can also remove bacteria and protozoa.
- Development in UV disinfection allows a low dosage to inactivate protozoa, so chlorine can be used for bacterial compliance and to maintain a residual in the distribution system.

The DWSNZ do not include any compliance criteria for viruses. All of the above disinfection processes (except chloramine) inactivate most viruses.

Risk management issues related to design and operation are covered in the MoH Public Health Risk Management Plan Guide PHRMP Ref: Ref: P11: Treatment Processes – Plant Construction and Operation.

USEPA (2007) is a useful manual covering many aspects of water treatment.

WQRA (2010) discusses the removal of natural organic matter (NOM) by coagulation flocculation, oxidative treatments, adsorption processes, ion exchange processes, membrane processes, biological treatment techniques, slow sand filtration and BAC filtration.

# References

- AWWA. 1990. *Water Quality and Treatment* (4th edition). Published for American Water Works Association by McGraw-Hill Inc.
- Collins R, McLeod M, Donnison A, et al. 2005. *Surface Runoff and Riparian Management III*. NIWA Client Report 2005-054 to the Ministry of Agriculture and Forestry, Wellington. This document can be accessed from <http://maxa.maf.govt.nz/mafnet/publications/techpapers/06-02/page-04.htm>.
- Couper SJ, Fullerton RW. 1995. *Pilot Plant Trials: Seeking the most cost-effective solution*. Annual Conference, New Zealand Water and Wastes Association.
- DSIR. 1988. *Hydrologists' Field Manual*. Hydrology Centre Publication No. 15. Christchurch. (Now NIWA.)
- Duncan M, Woods R. 2004. Flow regimes. In J Harding, P Mosley, C Pearson, et al (eds) *Freshwaters of New Zealand*, pp 7.1–7.14. Christchurch: New Zealand Hydrological Society and New Zealand Limnological Society, Caxton Press.
- Gerba CP, Nwachuku N, Riley KR. 2003. Disinfection resistance of waterborne pathogens on the United States EPA's contaminant candidate list. *Journal of Water Supply Research and Technology* 52: 81–94.
- Hickey CW. 1995. Ecotoxicity in New Zealand. *Australian Journal of Ecotoxicology* 1: 43–50.
- Hickey CW. 2000. Ecotoxicology: laboratory and field approaches. In KC Collier, M Winterbourn (eds) *New Zealand Stream Invertebrates: Ecology and Implications for Management*, pp. 313–43. Christchurch: New Zealand Limnological Society.
- Hoare RA, Spigel RH. 1987. Water balances, mechanics and thermal properties. In WN Vant (ed) *Lake Managers Handbook*, pp 41–58, Water and Soil Miscellaneous Publication No. 103. Wellington: Ministry of Works and Development.
- Holland P, Rahman A. 1999. *Review of Trends in Agricultural Pesticide Use in New Zealand*. MAF Policy Technical Paper 99/11. 54 pp. See <http://www.maf.govt.nz/mafnet/rural-nz/sustainable-resource-use/resource-management/pesticide-use-trends/PesticideTrends.PDF> or <http://citeseerx.ist.psu.edu/viewdoc/download?doi=10.1.1.62.1461&rep=rep1&type=pdf>.
- LAWA. 2013. Turbidity Recording Measurement, Processing and Archiving of Turbidity Data. National Environmental Monitoring Standards (NEMS). Version: 1.0. 74 pp. <http://www.lawa.org.nz/media/16586/nems-turbidity-recording-2013-06.pdf>.
- Lentz M, Kennedy P, Jones P, et al. 1998. *Review of Environmental Performance Indicators for Toxic Contaminants in the Environment: Air, water and land*. Environmental performance indicators. Technical Paper No. 37 Toxic. Wellington: Ministry for the Environment. 105+ pp. <http://www.mfe.govt.nz/publications/air/epi-toxic-review-oct98.html>.
- McBride GB. 2005. *Using Statistical Methods for Water Quality Management: Issues, options and solutions*. New York: Wiley.

- McGuigan KG, Joyce TM, Conroy RM, et al. 1998. Solar disinfection of drinking water contained in transparent plastic bottles: Characterising the bacterial inactivation process. *Journal of Applied Microbiology* 84: 1138–48.
- Medema GJ, Shaw S, Waite M, et al. 2003. Chapter 4. Catchment characterisation and source water quality, pp 111–58. In *Assessing Microbial Safety of Drinking Water*. OECD, World Health Organization.
- MoE. 2001. *Drinking Water treatment 2001*. Ontario, Canada: Ministry of the Environment.
- Note: The New Zealand Ministry of Health’s Guides for drinking-water supplies can be accessed as Word documents on the Ministry of Health website: <http://www.health.govt.nz/water> then select publications and Water Safety Plans.
- MoH Public Health Risk Management Plan Guide PHRMP Ref: S2. *Development of New Supplies*. Wellington: Ministry of Health.
- MoH Public Health Risk Management Plan Guide PHRMP Ref: P1.1. *Surface Water Abstraction – Rivers, Streams and Infiltration Galleries*. Wellington: Ministry of Health.
- MoH Public Health Risk Management Plan Guide PHRMP Ref: P1.2. *Surface Water Abstraction – Lakes and Reservoirs*. Wellington: Ministry of Health.
- MoH Public Health Risk Management Plan Guide PHRMP Ref: P4.4. *Pre-treatment Processes – Waste Liquor Reintroduction*. Wellington: Ministry of Health.
- MoH Public Health Risk Management Plan Guide PHRMP Ref: Ref: P11. *Treatment Processes – Plant Construction and Operation*. Wellington: Ministry of Health.
- Ogilvie D. 1983. *Changes in Water Quality after Impoundment*. Paper presented at the XVth Pacific Science Congress: Changes in Freshwater Ecosystems.
- PCE. 2004. *Growing for Food*. Wellington: Parliamentary Commissioner for the Environment.
- Rutherford JC. 1994. *River Mixing*. New York: Wiley.
- Selvarajah, N, Maggs GR, Crush JR, et al. 1994. Nitrate in groundwater in the Waikato region. In LD Currie, P Loganathan (eds) *The Efficient Use of Fertilisers in a Changing Environment: Reconciling productivity with sustainability*, pp 160–185. Occasional report no. 7. Palmerston North: Fertiliser and Lime Research Centre, Massey University.
- Sinton L. 1986. *A Guide to Groundwater Sampling Techniques*. National Water and Soil Conservation Authority, Water and Soil Miscellaneous Publication No. 99.
- Smith DG. 1986. Heavy metals in the New Zealand aquatic environment: a review. *Water and Soil Miscellaneous Publication No. 100*. Wellington: Ministry of Works and Development, 108 pp.
- Sobsey MD. 1989. Inactivation of health-related micro-organisms in water by disinfection processes. *Water Science and Technology* 21: 179–95.
- Stanfield G, Le Chevallier M, Snozzi M. 2003. Chapter 5. Treatment efficiency, pp 159–178. In *Assessing Microbial Safety of Drinking Water*. OECD: World Health Organization.



Sundaram B, Feitz A, Caritat P de, et al. 2009. *Groundwater Sampling and Analysis: A field guide*. Commonwealth of Australia, Geoscience Australia, Record 2009/27, 95 pp. [https://www.ga.gov.au/products/servlet/controller?event=GEOCAT\\_DETAILS&catno=68901](https://www.ga.gov.au/products/servlet/controller?event=GEOCAT_DETAILS&catno=68901).

UKWIR. 2000. *Guidance Manual Supporting the Water Treatment Recommendations from the Badenoch Group of Experts on Cryptosporidium* (2nd edition). Report No. 00/DW/06/10. London: UK Water Industry Research Limited.

USEPA. 2002. *Filter Backwash Recycling Rule, Technical Guidance Manual*. Office of Ground Water and Drinking Water, EPA 816-R-02-014. 178 pp. [http://www.epa.gov/ogwdw/mdbp/pdf/filterbackwash/fbrr\\_techguidance.pdf](http://www.epa.gov/ogwdw/mdbp/pdf/filterbackwash/fbrr_techguidance.pdf) or go to <http://water.epa.gov/lawsregs/rulesregs/sdwa/mdbp/index.cfm>.

USEPA. 2007. *Simultaneous Compliance Guidance Manual for the Long Term 2 and Stage 2 DBP Rules*. EPA 815-R-07-017. 462 pp. [http://www.epa.gov/ogwdw/disinfection/stage2/pdfs/guide\\_st2\\_pws\\_simultaneous-compliance.pdf](http://www.epa.gov/ogwdw/disinfection/stage2/pdfs/guide_st2_pws_simultaneous-compliance.pdf).

Ward RC, Loftis JC, McBride GB. 1990. *Design of Water Quality Monitoring Systems*. New York, NY: Van Nostrand Reinhold. 231 pp.

Wilcock RJ. 1989. *Patterns of Pesticide Use in New Zealand*. Part 1: North Island 1985–1988. Water Quality Centre Publication No. 15. Hamilton: DSIR.

Wilcock RJ, Close ME. 1990. *Patterns of Pesticide Use in New Zealand*. Part 2: South Island 1986–1989. Water Quality Centre Publication No. 16. Hamilton: DSIR.

Wilcock RJ. 1993. Application of land-use data and screening tests for evaluating pesticide runoff toxicity. *Environmental Management* 17(3): 365–71.

WHO. 2003. *Assessing Microbial Safety of Drinking-water: Improving approaches and methods*. Published on behalf of the World Health Organization and the Organisation for Economic Co-operation and Development by IWA Publishing, London. Available at: [http://www.who.int/water\\_sanitation\\_health/dwq/9241546301/en/index.html](http://www.who.int/water_sanitation_health/dwq/9241546301/en/index.html).

WHO. 2004a. *Guidelines for Drinking-water Quality 2004* (3rd ed). Geneva: World Health Organization. Available at: [www.who.int/water\\_sanitation\\_health/dwq/gdwq3/en/print.html](http://www.who.int/water_sanitation_health/dwq/gdwq3/en/print.html) see also the addenda.

WHO. 2004b. *Chemical Safety of Drinking-water: assessing priorities for risk management*. Geneva: World Health Organization. See [http://www.who.int/water\\_sanitation\\_health/dwq/cmp/en/](http://www.who.int/water_sanitation_health/dwq/cmp/en/).

WHO. 2004c. *Water Treatment and Pathogen Control: Process efficiency in achieving safe drinking water*. Published on behalf of WHO by IWA Publishing. Available at: [http://www.who.int/water\\_sanitation\\_health/dwq/9241562552/en/index.html](http://www.who.int/water_sanitation_health/dwq/9241562552/en/index.html).

WHO. 2009. *Scaling Up Household Water Treatment among Low-Income Populations*. WHO/HSE/WSH/09.02. Geneva: World Health Organization. [http://www.who.int/household\\_water/research/household\\_water\\_treatment/en/index.html](http://www.who.int/household_water/research/household_water_treatment/en/index.html).

WHO. 2011. *Guidelines for Drinking-water Quality 2011* (4th edition). Geneva: World Health Organization. Available at:  
[http://www.who.int/water\\_sanitation\\_health/publications/2011/dwq\\_guidelines/en/index.html](http://www.who.int/water_sanitation_health/publications/2011/dwq_guidelines/en/index.html).

WHO. 2011a. *Evaluating Household Water Treatment Options: Health-based targets and microbiological performance specifications*. 68 pp.  
[http://www.who.int/water\\_sanitation\\_health/publications/2011/evaluating\\_water\\_treatment.pdf](http://www.who.int/water_sanitation_health/publications/2011/evaluating_water_treatment.pdf).

WHO. 2016. *Protecting surface water for health. Identifying, assessing and managing drinking-water quality risks in surface-water catchments*. Geneva: World Health Organization. 196 pp.  
[http://www.who.int/water\\_sanitation\\_health/publications/pswh/en/](http://www.who.int/water_sanitation_health/publications/pswh/en/).

WHO. 2017. *Guidelines for drinking-water quality: fourth edition incorporating the first Addendum*. Geneva: World Health Organization. 631 pp.  
[http://www.who.int/water\\_sanitation\\_health/publications/drinking-water-quality-guidelines-4-including-1st-addendum/en/](http://www.who.int/water_sanitation_health/publications/drinking-water-quality-guidelines-4-including-1st-addendum/en/).

WQRA. 2010. *Dissolved Organic Carbon Removal by Biological Treatment*. Research Report 76. <http://www.waterra.com.au/publications/featured-publications/>.

WSAA. 2016. *The Catchment Management Investment Standard; in Source Catchments as Water Quality Treatment Assets*. Synthesis Report. 56 pp.  
<http://www.waterrf.org/PublicReportLibrary/4570C.pdf>.

# Chapter 5: General microbiological quality

## Contents

|            |   |           |
|------------|---|-----------|
| <b>5.1</b> | <b>Introduction</b>   | <b>2</b>  |
| <b>5.2</b> | <b>Micro-organisms in drinking-water</b>                    | <b>5</b>  |
| 5.2.1      | Introduction  | 5         |
| 5.2.2      | Controlling waterborne infection – historical overview      | 7         |
| 5.2.3      | Maximum acceptable value (MAV)                              | 9         |
| <b>5.3</b> | <b>Microbial indicators</b>                                 | <b>10</b> |
| 5.3.1      | Introduction  | 10        |
| 5.3.2      | Bacterial indicators  | 12        |
| 5.3.3      | Pathogenic protozoal indicators                             | 14        |
| 5.3.4      | Pathogenic viral indicators                                 | 16        |
| 5.3.5      | Secondary bacterial indicators                              | 17        |
| 5.3.6      | Indicators of general quality                               | 18        |
| 5.3.7      | Indicators of effectiveness of treatment                    | 20        |
| <b>5.4</b> | <b>Waterborne pathogens</b>                                 | <b>21</b> |
| 5.4.1      | Testing for specific pathogens                              | 21        |
| 5.4.2      | Bacterial pathogens from faecal contamination               | 24        |
| 5.4.3      | Bacterial pathogens growing in the water supply             | 25        |
| 5.4.4      | Viruses   | 25        |
| 5.4.5      | Pathogenic protozoa   | 26        |
| 5.4.6      | Helminths   | 31        |
| 5.4.7      | Cyanobacteria (blue-green algae)                            | 31        |
| 5.4.8      | Disease from waterborne pathogens                           | 32        |
| <b>5.5</b> | <b>Organisms causing problems other than disease</b>        | <b>33</b> |
| 5.5.1      | General   | 33        |
| 5.5.2      | Organisms causing taste and odour                           | 34        |
| 5.5.3      | Micro-organisms causing colour                              | 34        |
| 5.5.4      | Iron and manganese deposits due to bacteria                 | 34        |
| 5.5.5      | Corrosion resulting from iron and sulphur bacteria activity | 35        |

|                   |   |           |
|-------------------|---|-----------|
| 5.5.6             | Large numbers of micro-organisms          | 36        |
| 5.5.7             | Invertebrate inhabitants of water systems | 36        |
| <b>References</b> |   | <b>37</b> |

## List of tables

|            |   |    |
|------------|---|----|
| Table 5.1: | Waterborne pathogens and their significance in water supplies | 23 |
|------------|---|----|

# 5.1 Introduction

This chapter discusses the microbiological quality of drinking-water in general terms. Microbiological compliance issues are discussed as follows:

- Chapter 6: Bacterial Compliance
- Chapter 7: Virological Compliance
- Chapter 8: Protozoal Compliance
- Chapter 9: Cyanobacterial Compliance.

Infectious, water-related diseases are a major cause of morbidity and mortality worldwide. Newly-recognised pathogens and new strains of established pathogens are being discovered that present important additional challenges to both the water and public health sectors. Between 1972 and 1999, 35 new agents of disease were discovered and many more have re-emerged. Amongst these are pathogens that may be transmitted by water (WHO 2003b). There are suggestions that giardiasis was spread around the world by the mobility of armed forces during WWII. The first case of human cryptosporidiosis was reported in 1976, and by 1985 this 'new' pathogen was becoming more widely recognised.

The microbiological quality and the likelihood that a pathogen (disease causing organism) will be transmitted through drinking-water is dependent on numerous factors. Some of these reflect the characteristics of the pathogen itself, including resistance to environmental conditions such as ultraviolet light, desiccation, temperature, etc.

Many of these pathogens are zoonotic. Zoonoses are diseases caused by micro-organisms of animal origin that also infect humans. Zoonoses are of increasing concern for human health; next to pathogens with human-to-human transmission, they pose the greatest challenges to ensuring the safety of drinking-water and ambient water, now and in the future. See WHO (2004b) – a 528-page document.

The phenomena of 'emergence' and 're-emergence' of infectious diseases is well recognised. Up to 75 percent of emerging pathogens may be of zoonotic origin. WHO (2012) states in Chapter 2 that a pathogen or disease-causing agent is considered 'emerging' when it makes its appearance in a new host population or when there is a significant increase in its prevalence in a given population. A significant number of emerging and re-emerging waterborne pathogens have been recognised over recent decades; examples include *E. coli* O157:H7, *Campylobacter*, and *Cryptosporidium*. Public health scientists are increasingly discovering that the recent emergence or re-emergence of infectious diseases has an origin in environmental change. These environmental changes encompass social processes such as urbanisation and creation of transportation infrastructure, as well as ecologic processes such as land and water use, biodiversity loss, and climate change.

Between 1972 and 1999, 35 new agents of disease were discovered, and many more have re-emerged after long periods of inactivity or are expanding into areas where they have not previously been reported. From WHO (2017).

The frequency with which emerging communicable diseases are identified seems to be increasing. The rationale is well recognised as being the consequence of:

- increasing urbanisation with the movement of humans to major population centres being matched by the movement of vertebrate and invertebrate species into urban areas as well. The increased socialisation of individuals provides new opportunities for pathogen spread
- the phenomenal increase in international travel, in particular air travel, has provided opportunities for pathogens to travel along pathways between states with relative freedom and with increased speed and volume
- it is noted that since the end of the 1990s epidemiologists have been challenged by a succession of events which have featured either novel infections (SARs, H1N1, H5NI) or legacy infections that have been transferred to naïve populations (West Nile Virus in North America, Chikungunya in South Asia and Italy).

The overuse, careless use, inappropriate use and unregulated use of many antibiotics and other antimicrobial agents in both human and veterinary medicine are well documented, as is the extensive and largely unregulated use of these agents in animal agriculture and aquaculture, including for growth promotion. Uncontrolled release and disposal of these agents to sanitary sewers and landfills and in effluent discharges from pharmaceutical production facilities are also known to occur. Many enteric bacterial pathogens and associated faecal indicator bacteria, such as *Escherichia coli* and enterococci, are now multiple antimicrobial resistant, with some so resistant that infections cannot be effectively treated. A study has linked clinical isolates of multidrug-resistant enteric bacteria to the same bacteria found in environmental waters that were implicated in a possible waterborne community salmonellosis outbreak, and there are other cases of increased human mortality and morbidity caused by antimicrobial-resistant bacteria. New strains or variants of highly resistant enteric bacteria of human health concern continue to emerge, are detectable in environmental media such as water and soil and are spreading globally, thus posing increased human health risks (WHO 2014).

Along with trends in animal populations and husbandry, the presence of a given pathogen (eg, *Campylobacter*) may vary considerably from time to time, and the intensity of shedding may be influenced by factors with their own underlying trends, such as the seasonality and changes in farm control and management practices.

Securing the microbial safety of drinking-water supplies is based on the use of multiple barriers, from catchment to consumer, to prevent the contamination of drinking-water or to reduce contamination to levels not injurious to health.

Faecally derived pathogens from contamination by human, animal or bird faeces are the principal concerns in setting health-based targets for microbial safety. Microbial water quality often varies rapidly and over a wide range and short-term peaks in pathogen concentration may increase disease risks considerably, with greater reliance on treatment processes.

WHO (2012) stated:

- Although there are a large number of zoonotic pathogens that affect humans, five are known to cause illness around the world with high-frequency: *Cryptosporidium*, *Giardia*, *Campylobacter*, *Salmonella* and *E. coli* O157. Efforts to control these pathogens are likely to be effective in controlling other related zoonotic pathogens whether known, as-yet-unrecognised or emergent.
- Domestic animals such as poultry, cattle, sheep and pigs generate 85 percent of the world's animal faecal waste, proportionally a far greater amount than the contribution by the human population. The faecal production rate and contribution to the environment of these animals can be as high as  $2.62 \times 10^{13}$  kg/year.
- Limiting zoonotic pathogen-shedding in farm or production facilities for domestic animals should be accomplished by preventing illness in livestock, through minimising exposure to pathogens, by increasing immunity, by manipulation of the animal gastrointestinal tract microbial ecology and by managing (including treating) animal waste to reduce the release of zoonotic pathogens into the environment.

Being a significant exporter of animal sourced protein means that the relevance of zoonotic diseases will be potentially much greater in New Zealand than in many other countries. For a more detailed discussion relating to waterborne diseases reported in New Zealand, see Chapter 1, section 1.1.3.

The words cyst, oocyst and (oo)cyst appear frequently in this chapter and in Chapter 8: Protozoal Compliance. The definitions in the *Drinking-water Standards for New Zealand* (DWSNZ) are:

- an oocyst is a thick walled structure within which *Cryptosporidium* zygotes develop and which serves to transfer the organism to new hosts
- a cyst is the non-motile dormant form of *Giardia* which serves to transfer the organism to new hosts
- (oo)cyst is an abbreviation for cyst and oocyst.

FAO (2003) provided a practical framework and a structured approach for the characterisation of microbiological hazards, either in the context of a full microbiological risk assessment or as a stand-alone process. It is aimed at assisting governmental and research scientists to identify the points to be addressed, the methodology for incorporating data from different sources, and the methodology of dose-response modelling. The guidelines focus on the adverse impact of a hazard as a result of ingestion of contaminated food and water.

WHO (2004d) covers many water treatment processes suitable for pathogen control. WHO (2005a) published advice for travellers on how to make drinking-water safe. WHO (2009) is a 143-page publication devoted to just *Cryptosporidium*.

DWI (2015a) published a report on the wholesomeness of water used for toilet flushing. Waters used for purpose include rainwater, greywater, and reclaimed wastewater. It includes the statement "New Zealand has been looking at greywater/rainwater use in non-residential buildings but does not allow dual pipe systems in residential properties for potential cross-connection reasons. The use of greywater for toilet flushing is also banned for similar reasons".

## 5.2 Micro-organisms in drinking-water

### 5.2.1 Introduction

WHO (2004) stated:

The human health effects caused by waterborne transmission vary in severity from mild gastroenteritis to severe and sometimes fatal diarrhoea, dysentery, hepatitis and typhoid fever. Contaminated water can be the source of large outbreaks of disease, including cholera, dysentery and cryptosporidiosis; for the majority of waterborne pathogens, however, there are other important sources of infection, such as person-to-person contact and food.

Most waterborne pathogens are introduced into drinking-water supplies in human or animal faeces, do not grow in water, and initiate infection in the gastrointestinal tract following ingestion. However, *Legionella*, atypical mycobacteria, *Burkholderia pseudomallei* and *Naegleria fowleri* are environmental organisms that can grow in water and soil. Besides ingestion, other routes of transmission can include inhalation, leading to infections of the respiratory tract (eg, *Legionella*, atypical mycobacteria), and contact, leading to infections at sites as diverse as the skin and brain (eg, *Naegleria fowleri*, *Burkholderia pseudomallei*).

Of all the waterborne pathogens, the helminth *Dracunculus medinensis* is unique in that it is the only pathogen that is solely transmitted through drinking-water.

New Zealand has many water supplies ranging from the fully treated large municipal supplies, to the small untreated supplies serving a community of say less than 100. Microbiological guidelines seek to ensure that water supplies are free from disease-causing micro-organisms. The provision of such a supply is of the utmost importance to the health of any community.

The most common and widespread health risk associated with drinking-water is contamination, either directly or indirectly through human, animal and occasionally bird faeces and with the micro-organisms contained in their faeces. If the contamination is recent and among the contributors there are carriers of communicable enteric diseases (diseases of the gut), some of the micro-organisms that cause these diseases may be present in the water. The degree of risk is related to the level of disease in the human or animal community at that time. Drinking this water or using it in food preparation may cause new cases of infection. Those at greatest risk of infection are infants and young children, people whose immune system is depressed, the sick and the elderly. Risebro et al (2012) found that "Contaminated small water supplies pose a substantial risk of infectious intestinal disease to young children who live in homes reliant on these supplies. By contrast older children and adults do not appear to be at increased risk".

The pathogenic organisms of concern in New Zealand include bacteria, viruses and protozoa. The diseases they cause vary in severity from mild gastroenteritis, to severe and sometimes fatal diarrhoea, dysentery, hepatitis, cholera, typhoid fever and campylobacteriosis.

A 15-month fortnightly survey of microbial health risk indicators and pathogens was carried out at 25 freshwater recreational and water supply sites distributed throughout New Zealand, for *E. coli*, *Clostridium perfringens* spores, F-RNA bacteriophage, somatic coliphage, human enteroviruses, human adenoviruses, *Cryptosporidium* oocysts, *Giardia* cysts, *Salmonella* and *Campylobacter* (MfE 2002 – the Bad Bugs Report). Viruses and *Campylobacter* were detected at all six water supply sites. There was very little difference between the drinking-water supply sites and the remaining site types with respect to the occurrence of pathogens and the concentrations of indicator organisms. The main issue for source waters is the high proportion of samples which contained *Campylobacter* (60 percent) and viruses (54 percent) and the ability of drinking-water treatment to inactivate or remove them. The widespread presence of *Campylobacter* indicates a need for considerable care with respect to small rural supplies, which have been implicated in campylobacteriosis previously (Eberhardt-Phillips et al 1997, Till et al 2008).

Massey University's Gastrointestinal Protozoa, Research and Services have been testing source waters for the Ministry of Health. A total of 520 samples have been collected from 20 sites across New Zealand, ie, 26 quarterly samples per site over a 6.5-year period ending July 2016. Samples have been tested for *Cryptosporidium* oocysts, *Giardia* cysts, *E. coli* and *Campylobacter*. Based on the sites and probable land use, the 20 sites have been split into four groups:

|   |                     |         |
|---|---------------------|---------|
| 1 | Groundwater/springs | 4 sites |
| 2 | Bush catchments     | 7 sites |
| 3 | Intermediate rivers | 5 sites |
| 4 | Lowland rivers      | 4 sites |



Observations: About 50 percent of lowland river samples contained protozoa. As expected, most *Cryptosporidium* oocysts in the 104 lowland river samples were found in autumn and spring. Only about 2 percent of samples from bush catchment and intermediate rivers contained protozoa. No samples from shallow groundwater/spring sites contained protozoa. Over 80 percent of samples from bush catchments and intermediate rivers contained *E. coli*, with arithmetic means around 4 to 175 per 100 mL. Both groups averaged about 10 percent of samples with *Campylobacter*. Results for the bush catchment and the intermediate river sites are not particularly different, the main difference being that the intermediate river samples contain about 2–3 times as many *E. coli* per 100 mL. Lowland rivers had *E. coli* in every sample, with an arithmetic mean around 275 per 100 mL. Lowland rivers also contained *Campylobacter* in more than 50 percent of samples. The sites with the most protozoa only need to meet 3-log removal.

While the classical waterborne diseases are caused by organisms originating in the gut of humans or animals, many organisms found in water are not, or at least not regularly, associated with the gut. Some of these may under certain circumstances cause disease in humans. They include the protozoan *Naegleria fowleri*, and a number of bacteria including *Aeromonas*, *Klebsiella*, *Legionella* spp, and some species of environmental mycobacteria. Refer to the individual datasheets for further information.

Infection is the main, but not the only problem associated with micro-organisms in drinking-water. Certain algae can produce toxins that affect humans and which may remain in the water even when the algae responsible have been removed, see Chapter 9: Cyanobacterial Compliance. Other 'nuisance organisms' can cause problems of taste, odour or colour, as well as deposits and corrosion, and while they may not cause disease, they are aesthetically unacceptable. The organisms concerned include iron, manganese, sulphur and nitrifying bacteria, nematodes, midges, crustacean, rotifers and mussels; these are discussed in AWWA (2004).

The supply of safe drinking-water involves the use of multiple barriers to prevent the entry and transmission of pathogens. The effectiveness of these multiple barriers should be monitored by a programme based on operational characteristics and testing for microbial indicators of faecal contamination and in some circumstances actual pathogens.

## 5.2.2 Controlling waterborne infection – historical overview

The value of a wholesome water supply has been recognised, at least in some quarters, for many centuries. Hippocrates described an association between water supplies and disease (Hippocrates, cited 1938) and Roman engineers went to great lengths to provide waters suitable in both quantity and quality for major cities.

Over recent centuries, urbanisation and industrialisation have increased the pressure upon water supplies and the systems of waste disposal. Thus it was that, by the middle of the 19th century, Britain was affected by major epidemics of cholera and endemic typhoid. John Snow and William Budd provided irrefutable evidence of the role of water in transmission of these two diseases.

Snow's case rested very simply on a comparison of cholera incidence among the customers of three London water companies (Snow 1855). One supplied filtered water; the second moved the source of its supply to a cleaner area of the River Thames, while the third persisted in supplying polluted River Thames water. Budd appreciated that the sewer was merely an extension of the diseased gut (Budd 1856) and applied what are now classical epidemiological concepts to the investigation of water as a vehicle for spreading typhoid.

As a result, filtration of river-derived water became legally required in London in 1859, and this practice gradually spread throughout Europe. By 1917, Sir Alexander Houston could draw attention to the effectiveness of London's systems of water treatment and delivery in stopping the waterborne transmission of typhoid. In America, he pointed out it was customary to consider as normal an annual mortality rate from typhoid of 20 or more per 100,000 of population (the rate in Minneapolis was 58.7). In London, however, the annual mortality from typhoid was 3.3 per 100,000 (Houston 1917).

Budd's relatively simple precautions against faecal-oral transmission of typhoid (use of strong disinfectants in the water-closet bucket) had been remarkably successful (Budd 1856). A century later, Hornick's experiments on volunteers helped to explain the success by showing the disease to be in some instances relatively difficult to catch (Hornick et al 1966). Around  $10^7$  *Salmonella* serovar Typhi bacteria caused disease in only fifty percent of his volunteer subjects. Kehr and Butterfield (1943), however, showed that a small minority of the population (about 1.5 percent) needed to ingest only a single typhoid organism to contract typhoid, and to protect these people clearly more elaborate precautions are needed.

When the need to protect drinking-water from faecal material was first recognised, the techniques available for the isolation of such organisms as *Salmonella* serovar Typhi and *Vibrio cholerae* were quite inadequate for practical purposes. Surrogates or indicators were needed, and the obvious candidates were common microflora from the gut, and so the use of indicator organisms became established. Testing water for ammonia was commonly used to indicate the presence of human wastes. An early consensus developed about the use of the coliform organisms, and in the early decades of the 20th century the work of Alexander Houston (1917) and Doris Bardsley (1934), among many others, helped to establish the validity of *Escherichia coli* (*E. coli*) as an indicator of faecal contamination.

Kehr and Butterfield (1943) showed the coliform test to be a useful indicator of *S. serovar* Typhi and they concluded that the presence of coliforms (as a bacterial group), even in moderate numbers, indicated a potential danger. They cited an outbreak in Detroit, Michigan, when on two successive days mean coliform counts in the water supply of only 3 and 10 per 100 mL were the indicator for an outbreak of waterborne typhoid. They also noted the very much higher risk of gastroenteritis associated with this low coliform count. For the eight cases of typhoid recorded in this outbreak, there were 45,000 cases of gastroenteritis.

Endemic and epidemic cholera and typhoid both still occur, transmitted through contaminated drinking-water, as demonstrated in Pristina (Yugoslav Typhoid Commission 1964), in South Africa (Kustner et al) and the cholera outbreak in Peru (Anderson 1991). The latest number of waterborne cholera cases from the World Health Organization is for the year 2000: 137,071 cases and almost 5,000 deaths. It should be noted that this figure does not include any cases from Bangladesh or Pakistan where cholera is endemic.

Fortunately, in New Zealand indigenous typhoid and cholera are now rare. Most cases are visitors from overseas or travellers returning to New Zealand. **Waterborne disease however remains a constant threat to public health.** Twenty cases of typhoid were notified in New Zealand in 2003, and one case of cholera. Typhoid carriers, and those people contracting the illness, have the potential to distribute large numbers of pathogens throughout the country where drinking-water protection and treatment systems are not operational. In addition there is the environmental risk from pathogens such as *Campylobacter*, *Salmonella*, *Cryptosporidium*, Hepatitis A and enterohaemorrhagic *E. coli* (EHEC). During 2003 nearly 15,000 cases of campylobacteriosis, 1,400 of salmonellosis, over 800 of cryptosporidiosis, 70 cases of Hepatitis A and 105 EHEC infections were reported in New Zealand (NZPHSR 2003).

### 5.2.3 Maximum acceptable value (MAV)

The use of a Maximum Acceptable Value (MAV) for *E. coli* for drinking-water requires an understanding of the use of microbiological indicator organisms as an indicator of the potential for the risk of pathogens being present. Whereas the MAV of a chemical determinand in a drinking-water represents its concentration that on the basis of present knowledge is not considered to cause any significant risk to the health of the consumer over a lifetime of consumption of the water, the use of MAVs for microbiological determinands is somewhat different.

The microbiological determinand *E. coli* is an indicator of recent faecal contamination. The quantification of *E. coli* is related to the absence or non-detectability of that micro-organism in a given volume of water. Such a value, when considered with the method of analysis and frequency of sampling for a given population, gives a probability that there is no significant risk of infection from micro-organisms of known health significance at the time of sampling. The presence of *E. coli* provides evidence of recent faecal contamination, and detection should lead to consideration of further action such as further sampling and investigation of inadequate treatment or breaches in distribution system integrity.

A MAV is given in the DWSNZ for *E. coli* as an indicator of the potential presence of pathogenic enteric bacteria, enteric viruses, and pathogenic protozoa. However, *E. coli* is not always a good indicator for viruses or protozoa.

A maximum indicator value (MIV) is a more appropriate parameter to use for bacteria than a MAV because *E. coli* is not monitored for health reasons, it is monitored as an indicator of faecal contamination, and therefore of the potential presence of pathogenic micro-organisms. However, for consistency with general (and historical) usage, the term MAV is used throughout the DWSNZ.

Historically and internationally, the guideline value, maximum contaminant level or MAV etc seems always to have been 'less than 1 per 100 mL', with the unit or test organism changing from *B. coli*, to total or presumptive coliforms, then faecal coliforms, to *E. coli*. Over the years, improved growth media and incubation conditions have enhanced selectivity, and quality assurance procedures have reduced the number of false positives and false negatives. But it's always been 'less than 1 per 100 mL'. The pattern was probably established with the original test methods over 100 years ago. It can't have had anything to do with infective doses, because only indicator organisms have been tested for, and the ratio of indicator organisms to pathogens would vary wildly. Retaining the 'less than 1 per 100 mL' for compliance testing has probably been more to do with pragmatism than science; water with 'less than 1 per 100 mL' seems not to have caused many illnesses over the years, ie, it seems to work! Water suppliers interested in more than just compliance testing are referred to Chapter 6, section 6.3.3.

## 5.3 Microbial indicators

### 5.3.1 Introduction

The detection of specific pathogens, including bacteria, viruses, protozoa and parasites is usually complex, expensive, time-consuming, and currently often not practically possible. It may take weeks to determine whether a sample actually contains a particular pathogen and whether it is infective. Furthermore, methods for parasitic cysts or oocysts (eg, *Giardia intestinalis*,<sup>1</sup> *Cryptosporidium hominis*<sup>2</sup> and *C. parvum*) have recovery efficiencies of typically less than 50 percent, and can be quite variable.

Therefore in monitoring microbiological quality, reliance is placed on relatively quick and simple tests for the presence of indicator organisms. At present this usually involves culturing the organisms on or in an appropriate growth medium. Selective media are usually chosen. These prevent or retard organisms other than the ones being targeted. There has been debate (Sinton 2006) whether culture techniques detect all the organisms. Are those that do not respond 'viable but non-culturable', or are they simply dead or injured beyond repair (ie, no longer pathogenic, ie, no longer infective)?

In addition to the indicator organisms specifically referred to in the DWSNZ, this section discusses heterotrophic plate counts (colony counts) that may be used to assess the general bacterial content of drinking water, and it considers phages. Chapter 7 discusses viruses.

Microbial indicators are micro-organisms that while not themselves pathogenic, indicate potential issues of microbiological water quality. The drinking-water industry commonly uses the following indicator organisms:

<sup>1</sup> Also known as *G. lamblia* and *G. duodenalis*.

<sup>2</sup> Previously called *Cryptosporidium parvum* (genotype 1).

- heterotrophic plate count (standard plate count, mesophilic plate count, aerobic plate count)
- total coliforms (presumptive coliforms)
- faecal coliforms (thermotolerant coliforms)
- *Escherichia coli* (*E. coli*).

An effective indicator organism for detecting faecal contamination of water should:

- always be present when faecal pathogens are present
- be present in faeces in large numbers so that the organisms can still be detected after considerable dilution
- be relatively easy and quick to detect
- survive in water at least as long as waterborne pathogens of faecal origin
- be as sensitive as pathogens to disinfection.

In assessing the results of their water study for the MoH, Massey University have found that *E. coli* and *Campylobacter* were important predictors for each other. A similar pattern was observed for *Giardia* and *Cryptosporidium*. However, the bacterial microbes were poor predictors of protozoan microbes and vice versa for the protozoan microbes.

Ideally, tests used to measure the numbers of indicator organisms in a sample must be specific to that organism, and they should encourage a high proportion of those present in the sample to grow. It has long been recognised that artificial culture media lead to only a very small fraction (0.01–1 percent) of the viable bacteria present being detected. Since MacConkey's development of selective media for *E. coli* and coliforms at the beginning of the 20th century, various workers have shown these selective agents inhibit environmentally or oxidatively stressed coliforms (WHO 2001, Chapter 13).

No single indicator fulfils all these considerations, nor is any suitable for all cases. All indicators have disadvantages that must be considered when interpreting test results, and expertise is thus mandatory in this area. Multiple indicator systems may be needed in certain circumstances. Nevertheless, if the indicators are satisfactory and monitoring is carried out appropriately, it should be possible to dispense with the use of complex tests for the specific pathogenic micro-organisms in all but a few cases. A vast amount of experience has accumulated from the use and interpretation of tests for indicator micro-organisms and considerable confidence can be placed on the results of these tests.

The most important point is that the presence of indicators of faecal contamination implies an increased risk of disease. For disease to occur, however, the indicators must be accompanied by pathogenic micro-organisms. The chances of this occurring are determined by the prevalence of the pathogens in the potential sources (people or animals) and in the catchment from which the water is drawn.

The occasional failure of indicators to predict disease underlines the prime importance of risk assessments and maintaining effective multiple barriers from catchment to tap to prevent faecal material from entering the water supply. Tests for the microbiological quality of water can only indicate breaches of the integrity of those barriers.

A history of the development of indicator organisms appears in Chapter 13 of WHO (2001).

### 5.3.2 Bacterial indicators

The coliform group of bacteria is a functionally-related group which belongs to a single taxonomic family (the Enterobacteriaceae) and comprises many genera and species. There are other genera in the Enterobacteriaceae family, such as *Salmonella* and *Shigella*, which are not considered coliforms. The Enterobacteriaceae includes the following genera which ferment lactose to acid and gas: *Escherichia*, *Klebsiella*, *Enterobacter* and *Citrobacter*. When the definition was changed to producing only acid, the following genera were included: *Yersinia*, *Serratia*, *Hafnia*, *Pantoea* and *Kluyvera*. The introduction of the enzyme-based  $\beta$ -galactosidase test added the following genera to the coliforms: *Cedecea*, *Ewingella*, *Moellerella*, *Rahnella* and *Yokenella*. All coliforms other than *Escherichia coli* can be present in the environment as well as faeces; in fact, their colonisation in the gut of warm blooded animals is usually through interaction with the environment (Stevens et al 2003).

Total coliforms represent only about 1 percent of the total population of bacteria in human faeces, which can be found in concentrations of about  $10^9$  bacteria per gram. In 1948 a more specific test was developed that measured faecal (thermotolerant) coliforms; these grow can at 44.5°C. The vast majority of thermotolerant coliforms are *E. coli* and to a lesser extent *Klebsiella*, *Enterobacter* and *Citrobacter*.

The DWSNZ use *Escherichia coli* (*E. coli*) as the bacterial indicator, with a maximum acceptable value (MAV) of less than 1 per 100 mL. This is unchanged from earlier editions. Faecal coliforms (or thermotolerant coliforms) and total coliforms (or presumptive coliforms) can be monitored instead of *E. coli*, but with the proviso that a positive result for either should be treated as a positive *E. coli* result. Given that one can obtain either faecal coliforms or total coliforms in the absence of *E. coli*, this option is generally more demanding.

The total coliform test can be very useful for checking whether a bore water supply has been affected by surface influences, during commissioning or maintenance; see sections 3.2.4.1, 3.2.5.2, 3.2.5.3, 3.2.5.4 and 3.2.5.5 for further information. The USEPA's Revised Total Coliform Rule still uses total coliforms (along with *E. coli*) for monitoring drinking water. The USEPA considers total coliforms a useful indicator of other pathogens for drinking water. Total coliforms are used to determine the adequacy of water treatment and the integrity of the distribution system. Their presence requires water suppliers to perform assessments to identify sanitary defects and subsequently take action to correct them (USEPA 2013).

Frequently finding total coliforms in distribution system and service reservoir samples in the absence of *E. coli* suggests biofilm development, which tends to occur more often in the summer, or contamination from the environment; total plate counts usually increase at the same time. Maintaining a chlorine residue is an effective technique for controlling this problem, if not the cause. Biofilm development can also occur on the surface of the casing or fittings, or as a result of contamination at the bore head. WHO (2004e) discusses microbial contaminants and growth of microorganisms in distribution networks and the practices that contribute to ensuring drinking-water safety in piped distribution systems.

The bacterial compliance criteria in the DWSNZ have made use of the observation that *E. coli* is rarely found in drinking-water if the free available chlorine content is at least 0.2 mg/L.

A few strains of *E. coli* may be pathogenic in the gut. However, this is irrelevant to the use of *E. coli* as an indicator organism. Both pathogenic and non-pathogenic strains of *E. coli* are equally important as indicators of faecal contamination, as are animal and human sources.

The arguments for using *E. coli* for compliance testing are compelling:

- it is a strict indicator of faecal contamination, whereas the faecal coliforms and total coliforms are not
- it is an organism, whereas the other two are groups of bacteria
- it is most usually present when pathogens are present (eg, as found in the New Zealand Freshwater Microbiological Research Programme in fortnightly sampling at five drinking-water abstraction sites over a 15-month period, McBride et al 2002)
- *E. coli* can survive for considerable periods in water, which is generally similar to some of the waterborne faecal pathogens
- it is routinely associated with health risk effects in water ingestion studies (eg, Dufour 1984)
- it is now amenable to rapid and accurate enumeration, eg, using the Colilert™ MPN system (and acceptable equivalents). Colilert detects both total coliforms and *E. coli*.

The absence of *E. coli* does not necessarily guarantee the absence of faecal contamination (particularly where multiple barriers are absent as, for example, when reliance is placed on disinfection alone). Absence of evidence does not logically denote evidence of absence. Although their presence is a definite indication of pollution, their absence suggests that pathogenic bacteria and viruses are probably absent also. A study of outbreaks of waterborne disease in the USA found that one third of water supplies responsible for disease outbreaks did not have any total coliforms isolated from within the system (Craun et al 1997), concluded that the presence of coliforms is sometimes a useful indicator for viruses and bacteria, but not for protozoan parasites.

There are some indications that *E. coli* may grow in favourable environmental conditions, especially in warm climates (Fujioka et al 1999). *E. coli* growth has been reported in food (including *E. coli* O157:H7) (Doyle 1997), tropical water (Bermúdez and Hazen 1988), subtropical waters and soil (Hardina and Fujioka 1991), water in animal drinking troughs (Lejeune et al 2001) and in temperate waters and sediments in water reservoirs near Sydney (N Ashbolt, University of New South Wales, personal communication). However the New Zealand Freshwater Microbiological Programme did not find evidence of such growth occurring (McBride et al 2002). *E. coli* is unlikely to grow in New Zealand distribution systems, so if they are found there and not in the water leaving the treatment plant, it suggests post-treatment contamination with faecal matter has occurred.

To date, bacteria, including *E. coli*, have been defined by their biochemical reactions in the laboratory, rather than being identified by something more specific like DNA. Therefore there will always be debates about which test methods are the most appropriate, and which produce false positives or negatives. A recent study illustrates this (DWI 2010). Debate will continue about incubation temperatures, chlorine stress, and whether lactose fermentation or galactosidase and glucuronidase reaction is more appropriate.

Some enteric pathogens may occur even when few, if any, *E. coli* are present. For example, organisms such as *Giardia* cysts or oocysts of *Cryptosporidium*, and some viruses, are relatively resistant to chlorine disinfection in comparison with the indicators that are generally used. They may therefore survive a disinfection process that kills the indicator organisms. Likewise, UV disinfection is not particularly effective against some types of virus.

*Clostridium perfringens* spores are highly resistant in the environment, and vegetative cells appear not to reproduce in aquatic sediments, which can be a problem with traditional indicator bacteria. It is one of the most resistant micro-organisms in water, with a half-life (time for a 50 percent reduction in concentration) of 60 to >300 days (WHO 2003c). Like protozoa and some viruses, *Clostridium perfringens* is more resistant to some disinfection processes (WHO 2001, Chapter 13). Finding *Clostridia* in water leaving the treatment plant generally indicates that there is a fault in the chemical or physical treatment that requires investigation and appropriate remedial action. *Clostridium perfringens* can be used to detect faecal contamination of groundwater after the more traditional indicator organisms such as *E. coli* have died.

### 5.3.3 Pathogenic protozoal indicators

*Giardia* and *Cryptosporidium* are two protozoal pathogens that have been implicated in a number of outbreak and sporadic disease patterns in New Zealand (as elaborated in Chapter 1: Introduction, section 1. *Giardia* spp. and *Cryptosporidium* spp. are widespread in many New Zealand water sources; they are endemic in livestock, domestic and feral animals. Therefore surface waters, including shallow (particularly unconfined) groundwater, must be considered to be potentially contaminated.



For drinking waters, the MAV in the DWSNZ is for infectious pathogenic protozoa. Although new methods of assessing the infectiousness of protozoa by using human cell cultures have been developed, they are not yet suitable for routine monitoring of drinking-water. Therefore the MAV is effectively for total protozoa.

The analytical procedure to be used is based on method 1623 (USEPA 2003). This measures both *Giardia* cysts and *Cryptosporidium* oocysts, without identifying species. Until another method is developed, it is accepted that this method can be used to indicate total protozoal pathogens. There is very limited information about the removal and/or inactivation of emerging parasitic protozoa or opportunistically pathogenic protozoa during water treatment (see section 5.4.5); datasheets have been prepared for some. In the absence of information, the fate of these protozoal pathogens is considered similar to that of *Giardia* and *Cryptosporidium* during water treatment.

To control pathogenic protozoa, the DWSNZ require that water be treated to ensure their removal or inactivation, or that secure bore water is used. The level of treatment required for surface waters and non-secure bore water is determined from the concentration of *Cryptosporidium* in the source water, see section 5.2.1 of the DWSNZ, and Chapter 8: Protozoa Compliance, section 8.2 in the *Guidelines*. The premise is that *Cryptosporidium* is known to be very resistant to treatment processes, and is smaller than *Giardia*, so is used as an indicator for all pathogenic protozoa. Thus the level of treatment selected to remove *Cryptosporidium* should also provide a level of protection from other less resistant pathogenic protozoa, including *Giardia*.

When sewage is the source of these pathogens, the anaerobic spore-forming bacterium *Clostridium perfringens* appears to be a suitable index for enteric viruses and parasitic protozoa. Spores of *C. perfringens* are largely of faecal origin, and are always present in sewage (about  $10^4$ – $10^5$  cfu per 100 mL). *Clostridium perfringens* is fairly resistant to lower doses of chlorine, so it has been suggested as an alternative indicator organism for protozoa; spores of *Clostridium perfringens* showed the strongest correlation ( $r = 0.76$ ) with *Cryptosporidium* in a study on the River Meuse, a stronger correlation than thermotolerant coliforms or turbidity (WHO 2003c).

Methods for the detection of *Giardia* and *Cryptosporidium* in water have advanced considerably in the last few years. Detecting these protozoa involves the filtration of large volumes of water as the (oo)cysts are usually present in very low numbers. Methods have been developed using filtration and immuno-based techniques with monoclonal antibodies for separation (immunomagnetic separation, IMS) and detection (immunofluorescence assay, IFA) to determine concentrations of (oo)cysts with confirmation through vital dye staining (DAPI) and differential interference contrast (DIC) microscopy. However, the recovery success of this process can be variable, monoclonals may vary in their avidity and specificity to (oo)cysts or cross-react with other animal species, and the methods are costly. Routine monitoring for *Cryptosporidium* and *Giardia* in treated water is therefore not recommended in the DWSNZ as the methods do not reliably identify strains that are infective to humans, nor determine if those detected are infective (Quintero-Betancourt et al 2002).

Molecular-based methods and tissue cell culture assays show promise in detecting low level contamination in environmental waters, differentiating human pathogenic species from those that are not pathogenic and assessing infectivity but they are still being evaluated.

Over a period of seven years, four large supplies in Utah collected *Cryptosporidium*, *E. coli* and turbidity data from seven water treatment plants that treat both reservoir and stream sources. The data represented analyses completed by two USEPA-approved protozoan laboratories and local state-certified laboratories for *E. coli*. Results of the statistical analyses indicated poor correlation between *Cryptosporidium* and *E. coli* and between *Cryptosporidium* and turbidity in all monitored water sources throughout the entire monitoring period. The analyses indicate that elevated concentrations of *E. coli* are not indicative of the presence of *Cryptosporidium* in surface water. Both *E. coli* and turbidity are poor surrogates for occurrence of *Cryptosporidium* at treatment plant intakes (Nieminski et al 2010).

Instead of routine monitoring of *Giardia* and *Cryptosporidium* in treated drinking-waters, the DWSNZ require that water treatment performance is monitored using a variety of operational criteria as a substitute to protozoa testing in order to demonstrate compliance with the *Giardia* and *Cryptosporidium* standard for total pathogenic protozoa. See Chapter 8.

### 5.3.4 Pathogenic viral indicators

It has been suggested that a significant amount of viral disease in communities may be the result of low-level viral contamination of water. If this is the case, then viral indicators need to be sought. Epidemiological evidence is not clear on this point, though there is often a suggestion that recognised outbreaks of waterborne viral disease are generally associated with the presence of bacterial indicators in water.

Viral studies usually use polio viruses (mostly derived from live oral vaccines) as indicators because of their continual seeding into the aquatic environment and their relative resistance to accepted levels of disinfection. However, they may not be adequate indicators for all viral diseases likely to be associated with contaminated water.

The understanding of the fate and behaviour of viruses in drinking-water systems is not yet sufficiently advanced to enable an explicit standard to be made. Refer to Chapter 7 for further information about viruses. Sections 5.3.7 and 5.4.4 also mention viruses/coliphages.

The bacteriophages (viruses that infect bacteria) of *E. coli* have been proposed as indicators of the survival of viral pathogens. Phages are excreted by a certain percentage of humans and animals all the time whereas viruses are excreted only by infected individuals for a short period of time. The excretion of viruses depends heavily on variables such as the epidemiology of various viruses, outbreaks of viral infections and vaccination against viral infections. Consequently there is no direct correlation between numbers of phages and viruses excreted by humans. Enteric viruses have been detected in water environments in the absence of coliphages (WHO 2001, Chapter 13).

Human enteric viruses associated with waterborne diseases are excreted almost exclusively by humans. Phages used as models/surrogates in water quality assessment are excreted by humans and animals. In fact, the faeces of animals such as cows and pigs generally contain higher densities of coliphages than that of humans, and the percentage of many animals that excrete phages tends to be higher than for humans. Differences between phages and enteric viruses are also reflected by differences in the efficiency of adsorption-elution techniques for their recovery (from Chapter 13, WHO 2001).

International collaboration is now leading to meaningful, universally accepted guidelines for the recovery and detection of phages in water environments, such as those produced by the International Organisation for Standardisation (ISO).

### 5.3.5 Secondary bacterial indicators

Faecal streptococci are a species of gram-positive cocci belonging to two genera, *Enterococcus* and *Streptococcus*. The relevant species are linked by common biochemical antigenic properties and are found in the faeces of humans and other animals. Many will grow in 6.5 percent sodium chloride solutions and at 45°C. WHO (2001) defines these (and discusses them further) in Chapter 13 as:

Faecal streptococci (FS) are Gram-positive, catalase-negative cocci from selective media (eg, azide dextrose broth or m-Enterococcus agar) that grow on bile aesculin agar and at 45°C, belonging to the genera *Enterococcus* and *Streptococcus* possessing the Lancefield group D antigen.

Enterococci include all faecal streptococci that grow at pH 9.6, 10°C and 45°C and in 6.5 percent NaCl. Nearly all are members of the genus *Enterococcus*, and also fulfil the following criteria: resistance to 60°C for 30 minutes and ability to reduce 0.1 percent methylene blue. The enterococci are a subset of faecal streptococci that grow under the conditions outlined above. Alternatively, enterococci can be identified directly as micro-organisms capable of aerobic growth at 44±0.5°C and of hydrolysing 4-methylumbelliferyl-β-D-glucoside (MUD, detecting β-glucosidase activity by blue fluorescence at 366nm), in the presence of thallium acetate, nalidixic acid and 2,3,5-triphenyltetrazolium chloride (TTC, which is reduced to the red formazan) in the specified medium (ISO/FDIS 7899-1 1998).

The enterococci test is increasingly replacing faecal streptococci as an indicator, as enterococci are clearly of faecal origin from warm-blooded animals (OECD/WHO 2003). It is often used in place of *E. coli* when monitoring the quality of seawater, including in New Zealand. In Europe small water supplies are governed by the Council Directive 98/83/EC of 3 November 1998 on the quality of water intended for human consumption. In England that legislation was incorporated into The Private Water Supplies Regulations 2009, which requires both Enterococci and *Escherichia coli* to be absent in 100 mL.

*Enterococcus* and *Streptococcus* occur regularly in faeces but not in such numbers, or so invariably, as *E. coli*. Certain species of *Enterococcus* can be found free-living in soil and thus their presence in water may be from a non-faecal source (Leclerc et al 1996; Manero and Blanch 1999). Thus while the specificity of this indicator is acceptable, it is less sensitive than *E. coli*. Its persistence in water is less than that of *E. coli*, and it is generally a poorer indicator of the presence of certain pathogens that die off slowly (eg, viruses).

Until bifidobacteria were suggested as faecal indicators, *Clostridium perfringens* was the only obligately anaerobic, enteric micro-organism seriously considered as a possible indicator of the sanitary quality of water. *Clostridium perfringens* is a spore-former and may be highly persistent in the aquatic environment, and it can be found frequently in environmental material, eg, in soil. So as an indicator, its application is limited to specific circumstances, and the interpretation of its significance is often difficult.

Despite the first isolation of bifidobacteria in the late 1800s and very high numbers in human faeces (11 percent of culturable bacteria), their oxygen sensitivity (as with most other strict anaerobes) has limited their role as useful faecal indicators in waters (WHO 2001).

An alternative, the H<sub>2</sub>S test, to measure *E. coli* has been suggested by the WHO (2002). This test uses less expensive equipment, and requires less operator skill, so will be particularly attractive in poorer countries. Some versions use ambient temperatures for incubation so it could be a useful test in remote areas or during emergencies, eg, when there is no electricity. While the H<sub>2</sub>S producing organisms may not all be coliforms, they are organisms typically associated with the intestinal tracts of warm-blooded animals.

### 5.3.6 Indicators of general quality

The heterotrophic plate count (HPC) method uses a standard culture technique to grow a wide range of aerobic mesophilic bacteria on a non-selective agar medium. The bacteria that grow in these conditions are almost always present in drinking-water and are therefore an indicator of overall cleanliness of the water supply system.

The WHO (2003a) published *Heterotrophic Plate Counts and Drinking-water Safety: The significance of HPCs for water quality and the human health*. A quote from Chapter 1 follows:

HPC testing has a long history of use in water microbiology. At the end of the 19th century, HPC tests were employed as indicators of the proper functioning of processes (and of sand filtration in particular) and thereby as indirect indicators of water safety. Use as a safety indicator declined with the adoption of specific faecal indicator bacteria during the 20th century. HPC measurements nevertheless continue to figure in water regulations or guidelines in many countries. HPC measurements are used:

- to indicate the effectiveness of water treatment processes, thus as an indirect indication of pathogen removal
- as a measure of numbers of regrowth organisms that may or may not have sanitary significance
- as a measure of possible interference with coliform measurements in lactose-based culture methods. This application is of declining value, as lactose-based culture media are being replaced by alternative methods that are lactose-free.

Elevated HPC levels occur especially in stagnant parts of piped distribution systems, in domestic plumbing, in bottled water and in plumbed-in devices, such as softeners, carbon filters and vending machines. The principal determinants of regrowth are temperature, availability of nutrients and lack of residual disinfectant. Nutrients may derive from the water body and/or materials in contact with the water.

Piped water systems of large buildings may incur greater growth than encountered elsewhere (because of storage tanks, extensive internal distribution networks and temperature-related growth). The principal health concerns in these networks are cross-connections and growth of *Legionella* bacteria, which are not detected by the HPC test procedures.

Colony counts (heterotrophic plate counts) can be a useful indicator to monitor operational performance. They represent bacteria that have entered the water supply or that have survived the treatment processes and are able to grow and produce viable colonies on the growth medium used for the tests, under specified conditions (eg, incubation time, temperature, laboratory technique). Not all bacteria in water will, however, grow under these test conditions. It is usually not the absolute concentration of HPC but a change in HPC concentration that is useful to the water industry.

In groundwater the biologically available organic carbon and thus heterotrophic metabolism are often limited. Thus HPC levels in groundwater are generally low and stable over time. Groundwater affected by surface effects may show variable or higher than expected HPC counts; total or faecal coliform testing can also be helpful. These tests can also be useful for investigating parts of the distribution system that may experience biofilm growth. Health Canada (2012) contains some helpful information.

Colony counts are usually determined after incubation at 20–22°C or at 35–37°C. Plate counts of bacteria able to grow at 20–22°C or at 35–37°C in a standard nutrient medium (heterotrophic counts) may be relevant to the nutrient status of the water but not the faecal pollution. In general, the practice in New Zealand is to use 22°C and 35°C. When reporting results it is important to include the test conditions.

The count at 22°C will favour many environmental organisms. It has little sanitary value but is useful in assessing the efficiency of water treatment, specifically the processes of coagulation, filtration and disinfection, each of which reduces bacterial numbers. It may be used to assess the cleanliness and integrity of the distribution system and the suitability of water for manufacturing food and drink where a high count may lead to spoilage.

The count at 35°C will include some environmental organisms and also some from faeces. A significant increase above normal in this count may be an early sign of contamination. For this reason, in many cases, the only heterotrophic plate count performed is that at 35°C.

Colony counts should only be used as an adjunct to routine monitoring for *E. coli*. When a large number of organisms is detected, some form of remedial action is recommended, such as cleaning of storage tanks or inspection and repair or disinfection of the reticulation system. It may be useful to identify the dominant organisms present, particularly where there is persistent bacterial growth in a reticulation system.

These counts are a useful measure of the general quality of a water supply and to some extent of the standard of treatment or the microbial condition of the distribution system. The numbers should fall substantially during treatment processes. Generally, well-maintained water supplies should have little difficulty in obtaining samples with colony counts as follows (using the pour-plate technique with standard plate count agar at 35°C for 48 hours):

- disinfected supply < 100 per mL colony-forming units
- undisinfected supply < 500 per mL colony-forming units.

New Zealand experience indicates that in a well-run large municipal supply the following counts can be readily attained:

- disinfected supply < 20 per mL colony-forming units
- undisinfected supply < 200 per mL colony-forming units.

It is not uncommon to find >1000 colony-forming units per mL in good quality drinking-water when incubating at 22°C for seven days.

### 5.3.7 Indicators of effectiveness of treatment

The effectiveness of treatment of raw water can be measured by following the progressive lowering of counts of coliforms, heterotrophic plate counts or *E. coli* following successive stages of treatment throughout the plant, leading, in the final stages, to their complete removal. Any viable bacterium detected after appropriate exposure to disinfectants provides a clear warning of a failure of treatment and therefore of a potential hazard to consumers.

When monitoring *E. coli*, most water suppliers test 100 mL samples, mainly because the MAV is expressed as <1 per 100 mL. It is tempting to think that a zero result means 'absence of' *E. coli*. Very large volumes of clean drinking-water can be tested using membrane filtration techniques. Results of say 1 per 10 L may be possible, ie, reporting 0.01 *E. coli* per 100 mL. Testing large volumes can be very useful when investigating treatment or distribution problems, particularly spasmodic problems, see section 6.3.3 in Chapter 6: Bacterial Compliance.

Other indicator systems such as faecal streptococci and, rarely, *Clostridium perfringens* spores, may also be used as they are particularly persistent to disinfection and so tend to indicate the efficacy of filtration processes.

While coliphages are common in sewage, somatic coliphage and F-specific RNA coliphages are found in low numbers in faeces so their presence in water is primarily as an index of sewage pollution rather than faecal contamination in drinking water (IAWPRC 1991). Nonetheless, a variety of coliphages (eg, F-RNA coliphage, MS2) have shown potential as model organisms for monitoring virus removal in drinking water treatment plants (Jofre et al 1995).

## 5.4 Waterborne pathogens

### 5.4.1 Testing for specific pathogens

A review of waterborne outbreaks in four Nordic countries during 1998–2012 showed caliciviruses (51 of 175 outbreaks) being the most common, followed by *Campylobacter* (36 outbreaks) and pathogenic *E. coli* (8 outbreaks). Among the calicivirus outbreaks, norovirus was identified in 86 percent (44 of 51 outbreaks), while in the remainder the specific type of calicivirus was not identified. Other identified pathogens included *Giardia* (5 outbreaks), *Cryptosporidium* (4), *Salmonella* (2), rotavirus (1) and *Shigella* (1 outbreak). There were also nine outbreaks where multiple pathogens were detected in patient specimens and/or water supplies (Guzman-Herrador et al 2015).

Tests for the presence of specific pathogenic organisms such as *Salmonella*, *Campylobacter* or *Cryptosporidium* are appropriate for special investigations and in the face of evidence of outbreaks of waterborne disease. These tests are not recommended for routine monitoring of water supplies, due to the cost, complexity of testing, and perhaps the interpretation of results. Under special circumstances they could become Priority 2 determinands.

Promising new techniques based on amplifying and identifying the specific gene or genetic fragments, for example, polymerase chain reaction (PCR), are revolutionising the monitoring and investigation of drinking-water supplies. They show particular potential for detection of pathogens. However, the technology has not yet been developed sufficiently for it to replace traditional methods and the costs in general are very high.

The use of monoclonal antibody techniques probably shows the most promising applications but this in addition still requires some development and application of cost factors to enable large-scale regular testing to be carried out as is required in the monitoring of water supplies.

Waterborne pathogens are discussed in AWWA (1999).

WHO (2011a) includes useful information (Annex 2: Potential biological and chemical hazards in building water supplies) about the incubation period, clinical symptoms and source of exposure for many bacteria and viruses. Covered are *Acinetobacter*, *Campylobacter*, *Escherichia coli* (enteroinvasive or enterotoxigenic), *E.coli* O157:H7 (enterohaemorrhagic), *Klebsiella* and other Gram-negative bacteria (*Serratia marcesans*, *Stentrophomonas maltophilia*, *Aeromonas*, *Burkholderia cepacia*, *Enterobacter*), *Legionella* spp, non-tuberculous or atypical *Mycobacterium* spp, (*M. gordonae*, *M. kansasii*, *M. marinum*, *M. xenopi*, *M. scrofulaceum*, *M. avium*, *M. chelonae*, *M. intracellulare* and *M. fortuitum*), *Pseudomonas aeruginosa*, *Salmonella*, *Salmonella* Typhi, *Shigella*, *Vibrio cholerae* 01 or 0139, adenoviruses, calicivirus: *Norovirus* and *Sapovirus*, enteroviruses, hepatitis A virus, rotavirus, *Cyclospora cayetanensis*, *Cryptosporidium parvum*, *Entamoeba histolytica*, *Giardia lamblia*, and some chemicals.

Health Canada (2013) issued their Guidance on Waterborne Bacterial Pathogens.

Section 2.5 in the chapter on management covers quantitative microbial risk assessment (QMRA). The QMRA method provides a framework for pathogenic micro-organisms that is analogous to the risk-based approach to setting guideline values for chemicals. It is based on WHO (2016).

Table 5.1 is a summary of the major waterborne pathogens and their significance in water supplies.



**Table 5.1: Waterborne pathogens and their significance in water supplies**

| Pathogen  | Health significance | Persistence in water supplies <sup>a</sup> | Resistance to chlorine <sup>b</sup> | Relative infectivity <sup>c</sup> | Important animal source |
|---|---------------------|--|-------------------------------------|-----------------------------------|-------------------------|
| <b>Bacteria</b>                                   |                     |  |                                     |                                   |                         |
| <i>Burkholderia pseudomallei</i>                  | High                | May multiply                               | Low                                 | Low                               | No                      |
| <i>Campylobacter jejuni</i> , <i>C. coli</i>      | High                | Moderate                                   | Low                                 | Moderate                          | Yes                     |
| <i>Escherichia coli</i> , Pathogenic <sup>d</sup> | High                | Moderate                                   | Low                                 | Low                               | Yes                     |
| <i>E. coli</i> – Enterohaemorrhagic               | High                | Moderate                                   | Low                                 | High                              | Yes                     |
| <i>Francisella tularensis</i>                     | High                | Long                                       | Moderate                            | High                              | Yes                     |
| <i>Legionella</i> spp.                            | High                | May multiply                               | Low                                 | Moderate                          | No                      |
| <i>Leptospira</i>                                 | High                | Long                                       | Low                                 | High                              | Yes                     |
| Mycobacteria (non-tuberculous)                    | Low                 | May multiply                               | High                                | Low                               | No                      |
| <i>Salmonella</i> Typhi                           | High                | Moderate                                   | Low                                 | Low                               | No                      |
| Other salmonellae                                 | High                | May multiply                               | Low                                 | Low                               | Yes                     |
| <i>Shigella</i> spp.                              | High                | Short                                      | Low                                 | High                              | No                      |
| <i>Vibrio cholerae</i>                            | High                | Short to long                              | Low                                 | Low                               | No                      |
| <i>Yersinia enterocolitica</i>                    | High                | Long                                       | Low                                 | Low                               | Yes                     |
| <b>Viruses</b>                                    |                     |  |                                     |                                   |                         |
| Adenoviruses                                      | Moderate            | Long                                       | Moderate                            | High                              | No                      |
| Astroviruses                                      | Moderate            | Long                                       | Moderate                            | High                              | No                      |
| Enteroviruses                                     | High                | Long                                       | Moderate                            | High                              | No                      |
| Hepatitis A                                       | High                | Long                                       | Moderate                            | High                              | No                      |
| Hepatitis E                                       | High                | Long                                       | Moderate                            | High                              | Potentially             |
| Noroviruses and Sapoviruses                       | High                | Long                                       | Moderate                            | High                              | Potentially             |
| Rotavirus   | High                | Long                                       | Moderate                            | High                              | No                      |
| Sapoviruses                                       | High                | Long                                       | Moderate                            | High                              | Potentially             |
| <b>Protozoa</b>                                   |                     |  |                                     |                                   |                         |
| <i>Acanthamoeba</i> spp.                          | High                | May multiply                               | High                                | High                              | No                      |
| <i>Cryptosporidium parvum</i>                     | High                | Long                                       | High                                | High                              | Yes                     |
| <i>Cyclospora cayetanensis</i>                    | High                | Long                                       | High                                | High                              | No                      |
| <i>Entamoeba histolytica</i>                      | High                | Moderate                                   | High                                | High                              | No                      |
| <i>Giardia intestinalis</i>                       | High                | Moderate                                   | High                                | High                              | Yes                     |
| <i>Naegleria fowleri</i>                          | High                | May multiply <sup>f</sup>                  | Low                                 | Moderate                          | No                      |
| <i>Toxoplasma gondii</i>                          | High                | Long                                       | High                                | High                              | Yes                     |
| <b>Helminths</b>                                  |                     |  |                                     |                                   |                         |
| <i>Dracunculus medinensis</i>                     | High                | Moderate                                   | Moderate                            | High                              | No                      |
| <i>Schistosoma</i> spp.                           | High                | Short                                      | Moderate                            | High                              | Yes                     |

Source: Ex WHO 2011 (Table 7.1).

- a This table contains pathogens for which there is some evidence of health significance related to their occurrence in drinking-water supplies. More information on these and other pathogens is presented in chapter 11 (WHO).
- b Health significance relates to the incidence and severity of disease, including association with outbreaks.
- c Detection period for infective stage in water at 20°C: short, up to one week; moderate, one week to one month; long, over one month.

- d When the infective stage is freely suspended in water treated at conventional doses and contact times and pH between 7 and 8. Low means 99% inactivation at 20°C generally in <1 minute, moderate 1–30 minutes and high >30 minutes. It should be noted that organisms that survive and grow in biofilms, such as *Legionella* and mycobacteria, will be protected from chlorination.
- e From experiments with human volunteers, from epidemiological evidence and from experimental animal studies. High means infective doses can be 1–102 organisms or particles, moderate 102–104 and low > 104.
- f Includes enteropathogenic, enterotoxigenic, enteroinvasive, diffusely adherent and enteroaggregative.
- g *Vibrio cholerae* may persist for long periods in association with copepods and other aquatic organisms.
- h In warm water.

## 5.4.2 Bacterial pathogens from faecal contamination

The human bacterial pathogens that can be transmitted orally by drinking-water and which present a serious risk of disease include *Salmonella* spp, *Shigella* spp, enteropathogenic *Escherichia coli*, *Vibrio cholerae*, *Yersinia enterocolitica*, *Campylobacter jejuni*, and *Campylobacter coli*.

While typical waterborne pathogens are able to persist in drinking-water, most do not grow or proliferate in water. Micro-organisms (eg, *E. coli* and *Campylobacter*) can accumulate in sediments and be mobilised with increased water flow or water flow fluctuations.

After being excreted in faeces from the body of their host, bacterial pathogens gradually lose viability and the ability to infect. The rate of decay varies with different bacteria. It is usually exponential and after a certain period a pathogen will become undetectable. The most common waterborne pathogens are those that are highly infectious or highly resistant to decay outside the body. Pathogens with a low persistence, ie, those that do not survive long outside the host, must rapidly find a new host and are more likely to be spread by person-to-person contact or by faulty personal or food hygiene than by drinking-water.

If present in drinking-water, faecal contamination and hence the related waterborne bacterial pathogens are likely to be dispersed widely and rapidly. Outbreaks of waterborne disease are therefore frequently characterised by an infection across a whole community.

Although bacterial contamination normally can be thought of as a short-term event, there are examples of long-term after effects. One example was at Queenstown (see Chapter 1). Another occurred at Walkerton in 2000 (also mentioned in Chapter 1). A seven-year follow-up study of Walkerton residents showed that many continued to experience long-term adverse health effects. One of the most severe complications of *E. coli* O157 infection is HUS (haemolytic uremic syndrome) and survivors of HUS may have permanent kidney damage, potentially requiring a kidney transplant later in life. Therefore there has been a particular focus on children who suffered HUS during the outbreak. The Year 3 follow-up of children who had HUS showed that 32 percent had microalbuminuria (trace amounts of albumin in the urine) compared to 5 percent of children who had not had HUS. However by Year 5 these rates had dropped to 20 percent and 3 percent respectively, and the Year 7 follow-up showed no worsening of the condition or any overt kidney disease in the children. These findings were more

favourable than had been predicted from previous literature on HUS, but continued monitoring of kidney function is still deemed desirable in HUS survivors. Also, it was found that among those who had experienced severe gastroenteritis during the outbreak, 36 percent had developed Irritable Bowel Syndrome, compared to 28 percent of those who had moderate gastroenteritis and 10 percent of those who had not been ill (WQRA 2010).

### 5.4.3 Bacterial pathogens growing in the water supply

Various bacteria that occur naturally in the environment may cause disease opportunistically in humans. Those most at risk are the elderly, the very young, people with burns or excessive wounds, those undergoing immunosuppressive therapy, or those with acquired immunodeficiency syndrome (AIDS). Water used by such people for drinking or bathing, if it contains large numbers of these opportunistic pathogens, can occasionally produce infections of the skin and of the mucous membranes of the eye, ear, nose and throat. Examples of such agents are *Pseudomonas aeruginosa*, species of *Klebsiella* and *Aeromonas*, and certain slow-growing mycobacteria such as *Mycobacterium avium*.

The World Health Organization (WHO 2004c) has published an excellent book bringing together a great deal of what is currently known about the mycobacteria. Refer also to the Datasheet in Volume 3 of these Guidelines.

Legionellosis, caused by the bacterium *Legionella pneumophila*, can be a serious illness. It results from inhalation of aerosols in which the causative organisms have been able to multiply because of warm conditions and the presence of nutrients. The WHO produced Fact Sheet #285 (February 2005) on legionellosis, available on [www.who.int/entity/mediacentre/factsheets/fs285/en/](http://www.who.int/entity/mediacentre/factsheets/fs285/en/). This was updated in book form (WHO 2007). Refer also to the Datasheet in Volume 3 of these Guidelines.

CRC (2009) covers the opportunistic growth of *Aeromonas hydrophilla* and *Burkholderia pseudomallei* in the distribution system.

### 5.4.4 Viruses

Viruses are among the smallest and more resilient of infectious agents. In essence they are nucleic acid molecules that can enter cells and replicate in them. The virus particle consists of a genome, either RNA or DNA, surrounded by a protective protein shell, the capsid. Frequently this shell is enclosed in an envelope that contains both protein and lipid. Viruses replicate only inside specific host cells and they are absolutely dependent on the host cells' synthetic and energy-yielding apparatus for producing new virus particles. Thus viruses are not known to multiply in the environment.

The viruses of most significance in relation to drinking-water are those that multiply in human gut tissues and are excreted in large numbers in the faeces and urine of infected individuals. Although they cannot multiply outside the tissues of infected hosts, some enteric viruses can survive in the environment and remain infective for long periods. Human enteric viruses occur in water largely as a result of contamination by sewage and human excreta. The numbers of viruses present and their species distribution will reflect the extent that the population is carrying them.

The different analytical methods currently available can also lead to wide variations in numbers of viruses found in sewage.

Sewage treatment may reduce numbers by ten to ten thousand-fold, depending on the nature and degree of treatment. However, even tertiary treatment of sewage will not eliminate all viruses. As sewage mixes with the receiving water, viruses are carried downstream and the length of time they remain detectable depends on temperature, their degree of absorption into sediments, penetration of sunlight into the water, pH and other factors. Consequently, enteric viruses can be found in sewage-polluted water at the intakes to water treatment plants.

Proper treatment and disinfection, however, should produce drinking-water that is essentially virus-free. The occurrence of human viruses in source waters and the effectiveness of various drinking water treatment approaches are discussed in Chapter 7: Virological Compliance.

## 5.4.5 Pathogenic protozoa

The majority of free-living protozoa (FLP) are aquatic organisms of no significance to public health. Protozoa can be differentiated into three general types: ciliates, flagellates and amoebae. They generally feed on other micro-organisms such as bacteria, algae, cyanobacteria, or other protozoa.

FLP are ubiquitous where bacteria, their main food source, are found. That they are present in distributed water is not a surprise, and it would be logical that the types and numbers of active FLP in distributed water relate directly to the quality and quantity of their food source present in infrastructure biofilms, and perhaps to a lesser extent in the bulk water. Over many years, water has been implicated as a source of opportunistic pathogens in healthcare and community disease outbreaks, particularly for the opportunistic respiratory pathogens *Legionella* spp. and *Mycobacterium* spp. Epidemiological data, along with laboratory reports of pathogens resisting digestion by amoebae, replicating inside amoebae, and dispersed by amoebae, have raised the spectre of FLP as Trojan horses delivering pathogens throughout distribution networks, and hence being real villains in the battle to provide safe drinking water. On the other hand, FLP almost certainly provide significant benefits to drinking water by removing/digesting bacteria in biofilms and bulk water. The issue of bacterial-FLP interactions is especially important for large volume water users and in recycled and warm water systems that are most implicated in the epidemiology of legionellae and mycobacterial infections (DWI 2015).

Protozoa likely to be found in drinking-waters and of public health significance can be grouped into those of enteric or environmental origin:

- enteric protozoa occur widely as parasites in the intestine of humans and other mammals and involve at least two stages (trophozoite and (oo)cyst) in their life cycle (see section 5.4.5.1)
- some free-living protozoa are opportunistic pathogens in humans and are responsible for some serious diseases of the nervous system and the eye (see section 5.4.5.2)
- an occurrence survey reported in DWI (2015) confirmed the ubiquity of FLP in all types of water tested. It identified a wide variety of FLP from all systems of distributed water. These included acanthamoebae and hartmannellae, but the most commonly observed and isolated FLP in all systems were cercomonads. These small FLP are flagellates with an amoeboid stage that are avid consumers of bacteria in bulk water as well as in biofilms and belong to the most common group of predators in soils and waters. They are not implicated in the epidemiology of either legionellae or mycobacteria and might be considered as beneficial consumers of bacteria including biofilms.

#### 5.4.5.1 Enteric parasitic protozoa

The most prevalent enteric protozoal parasites associated with waterborne disease include *Giardia intestinalis*, *Cryptosporidium hominis* and *C. parvum*. *Toxoplasma gondii*, *Entamoeba histolytica*, and *Balantidium coli* have also been associated with waterborne outbreaks. *Cryptosporidium*, a coccidian protozoal parasite, was only identified as a human pathogen in 1976. It can cause diarrhoeal illness in the immunocompetent but with dire consequences in immunocompromised individuals. The disease is endemic throughout the world. The incidence of infection is also high, illustrated by the finding that in the USA 20 percent of young adults have evidence of infection by *Cryptosporidium*. This rate was over 90 percent amongst children under one year old in a Brazilian shanty town (quoted in WHO 2003(b): *Emerging issues in water and infectious diseases*). Analysis of a Swedish outbreak of *Cryptosporidium hominis* showed that nearly half the inhabitants were infected (Widerström et al 2014).

Epidemiological studies often report cases as incidence per (say 1000) population. Sometimes prevalence is used, being a better indicator of disease burden due to the longer duration of cryptosporidiosis. Incidence is defined as the number of incidents and prevalence as the number of days with diarrhoea in a given time period.

Other emerging protozoal parasites of concern include *Cyclospora cayetanensis* and *Isospora belli*. Microsporidia are also emerging pathogens of public health importance and, although recently classified as fungi, their fate and behaviour in water can be similar to that of the parasitic protozoa.

The transmissive/infective stages of these parasites are cysts (*Giardia*, *Balantidium*, *Entamoeba*), oocysts (*Cryptosporidium*, *Cyclospora*, *Isospora*, *Toxoplasma*) or spores (Microsporidia). These forms are excreted in faeces of infected hosts as fully infectious agents (*Giardia*, *Cryptosporidium*, Microsporidia, *Balantidium*) or as immature stages (*Cyclospora*, *Isospora*, *Toxoplasma*) requiring a short period of development in the environment to reach the mature stage. They can get into drinking-water supplies by

contamination with human or animal faeces. All are widely dispersed and have been associated with outbreaks of infection resulting from drinking contaminated water, see datasheets (Volume 3).

*Giardia* and *Cryptosporidium* are the most widely reported causes of waterborne parasitic disease in developed countries. In New Zealand giardiasis and cryptosporidiosis are the third and fourth most commonly notified diseases, respectively. The following plots show the temporal trends in cryptosporidiosis and giardiasis in New Zealand; data are from ESR, and were included in a report from Massey University to the MoH in 2016.

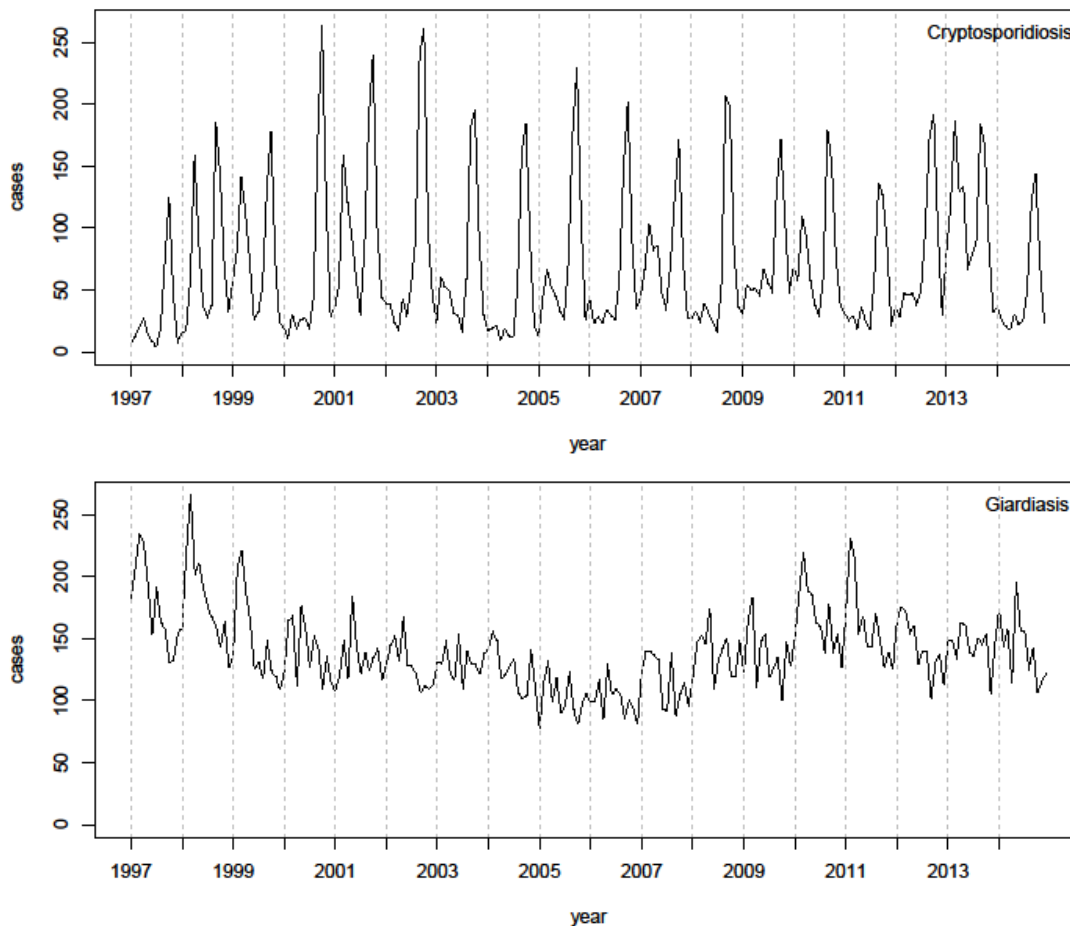

These organisms cause varying degrees of enteric condition that can be manifested from violent diarrhoea symptoms to being asymptomatic. Immunocompetent people typically recover without intervention. Dehydration is the most frequent symptom requiring attention in severely affected individuals.

The (oo)cysts of *Giardia* and *Cryptosporidium* are widespread in environmental waters of New Zealand especially in water from areas of intensive stock farming and they can occur in high concentrations. A recent study of measures that can be taken to reduce the numbers of (oo)cysts in water appears in Victorian Department of Health (2011). Coliforms, faecal coliforms, and *E. coli* have been shown to be poor indicators of the presence of pathogenic protozoa in drinking-water, so *Giardia* and *Cryptosporidium* are considered as Priority 1 determinands in the DWSNZ.

The organisms can survive for a long time in cold water. Medema et al (1997) conducted bench scale studies of the influence of temperature on the die-off rate of *Cryptosporidium* oocysts. Die-off rates were determined at 5°C and 15°C. Both excystation and vital dye staining were used to determine oocyst viability. At 5°C, the die-off rate was 0.010 log<sub>10</sub>/day, assuming first order kinetics. This translates to 0.5 log reduction at 50 days. At 15°C, the die-off rate in natural river water approximately doubled to 0.024 log<sub>10</sub>/day (excystation) and 0.018 log<sub>10</sub>/day (dye staining).

Sattar et al (1999) evaluated factors impacting *Cryptosporidium* and *Giardia* survival. Microtubes containing untreated river water were inoculated with purified oocysts and cysts. Samples were incubated at temperatures ranging from 4 to 30°C; viability of oocysts and cysts was measured by excystation. At 20°C and 30°C, reductions in viable *Cryptosporidium* oocysts ranged from approximately 0.6 to 2.0 log after 30 days. Relatively little inactivation took place when oocysts were incubated at 4°C.

The significance of waterborne transmission in New Zealand is still not clear. The prevalence of *Giardia* and *Cryptosporidium* infection in livestock, domestic, and feral animals suggests a significant reservoir for zoonotic transmission. However, information is needed on the presence of human and animal specific genotypes in water in order to clarify the relative importance of human or animal derived waterborne infections. The datasheets provide further detailed descriptions of the enteric protozoa. Chapter 8: Protozoa Compliance also provides further information relating to *Cryptosporidium*.

A thorough discussion on the impact of waterborne *Giardia* and *Cryptosporidium* internationally appears in WHO (2012, see Chapter 2 in particular).

#### 5.4.5.2 Opportunistically pathogenic free-living protozoa

Free-living protozoa (FLP) are numerous in open surface waters including water supply sources but greatest numbers can be found in nutrient enriched environments where their bacterivorous feeding activities are of great benefit, eg, in biological wastewater treatment systems. FLP are ubiquitous in aquatic environments with a wide tolerance to environmental conditions ranging from geothermal waters, thermally polluted waters, to water distribution pipes.

The most well-known free-living, opportunistically pathogenic protozoa are the free-living amoebae, *Naegleria*, *Acanthamoeba* and more recently *Balamuthia*, which cause cerebral or corneal diseases. Infection is opportunistic and usually associated with recreational bathing-water contact or domestic use of water other than drinking. The occurrence of *Naegleria* and *Acanthamoeba* in water is not necessarily associated with faecal contamination.

*Naegleria spp* have been responsible for nine recorded deaths in New Zealand since 1968: five cases were confirmed as *N. fowleri* (Cursons et al 2003). Infection by *N. fowleri* is strictly waterborne and can cause a cerebral infection known as primary amoebic meningoencephalitis (PAM), a rare but usually fatal condition. All cases of death resulting from *Naegleria* infections in New Zealand have been associated with swimming in geothermal pools or rivers receiving geothermal waters. These deaths led to more control of geothermal tourist areas with specific advice on pool care including

exclusion of soil from the water sources and pools, filtration, disinfection, and rate of water turnover. CRC (2009) covers the opportunistic growth of *Naegleria fowleri* in the distribution system.

*Acanthamoeba* species are commonly found in soil and water and cause diseases of the central nervous system (granulomatous amoebic encephalitis GAE) and a disease of the eye called keratitis. GAE is invariably fatal but no cases of GAE have been reported in New Zealand to date. However, although GAE is not associated with swimming, a species known to cause the disease in humans, *Acanthamoeba culbertsoni*, has been isolated from New Zealand thermal waters. In contrast, amoebic keratitis does occur in New Zealand and there have been eight reported cases since 1995 (Ellis-Pegler 2003). The disease has been associated with people who wear soft contact lenses. *Acanthamoeba* spp has been isolated from contact lens washing fluid on several occasions.

*Balamuthia mandrillalis* causes GAE in humans and other animals. Little is known about the ecology of *Balamuthia*. They are present in soil and possibly water but there is no obvious association of waterborne transmission with those cases reported of *Balamuthia* infection (Schuster and Visvesvara 2004).

Both *Acanthamoeba* and *Naegleria* as well as other free-living amoebae are known to ingest bacterial pathogens such as *Legionella* (Brown and Barker 1999). *Legionella* spp. have adapted to replicate inside amoebae and thus the amoebae containing *Legionella* within their vacuoles can act as vectors for packets of *Legionella* infection.

Free-living amoebae can be found in source water and isolated from water distribution pipes. Their presence is usually associated with thermally polluted waters (eg, *Naegleria*) or inadequate disinfection of treated supplies.

Information is increasing on emerging enteric protozoa such as *Blastocystis* spp, *Dientamoeba fragilis* and *Endolimax nana*. Researchers have recently agreed that *Blastocystis* spp are pathogenic, causing intestinal disorders. Datasheets have been prepared for:

- *Acanthamoeba* sp.
- *Balantidium coli*
- *Blastocystis*
- *Cryptosporidium*
- *Cyclospora*
- *Entamoeba histolytica*
- *Giardia intestinalis* (*lamblia*)
- *Hartmanella vermiformis*
- *Isospora*
- *Microsporidia*
- *Naegleria fowleri*
- *Toxoplasma*.



## 5.4.6 Helminths

A variety of human and zoonotic helminth (worm parasite) diseases have been found in New Zealand, including *Fasciola*, an economically important zoonotic helminth parasite in cattle.

However, reports of helminth infections in the New Zealand human population occur rarely; infection is most often associated with recent immigrants or travellers returning from areas where disease is endemic.

Whilst infective helminth parasites should not be present in drinking-water, the low prevalence of helminth infection in New Zealand indicates that a Maximum Acceptable Value (MAV) in the DWSNZ is impractical for these disease organisms. Physical treatment processes used for the removal of protozoal parasites during drinking-water treatment should also remove helminths if these are present in the source water, as they are generally excluded by their size. Helminth infective stages are typically larger and heavier than protozoal (oo)cysts (>20 µm). Care is needed with microscopic identification of organisms from water supplies as adult worms and larvae are more likely to belong to free-living nematode groups such as *Turbatrix* or *Rhabditis*.

The majority of helminths are not typically transmitted through drinking-water. Exceptions are *Dracunculus* (Guinea worm) and in some endemic situations, *Fasciola* spp (liver fluke). Most helminth infections are acquired through direct faecal-oral contact (eg, *Enterobius*), ingestion of faecally contaminated food (eg, *Ascaris*, *Trichuris*), or through contact with contaminated soil or surface water (eg, hookworm, *Schistosoma* spp). However, helminth parasites can produce large numbers of transmissible stages (infective egg or larvae) that can sometimes be found in water, and there have been reports of incidental disease transmission due to consumption of contaminated water.

Although no MAV is prescribed for helminths in the DWSNZ, precautions should be taken to protect source water supplies from zoonotic helminth contamination, particularly in rural communities where livestock may be considered a viable reservoir and to ensure security of water during and post treatment.

Further information is provided in the helminth and nematode datasheet.

## 5.4.7 Cyanobacteria (blue-green algae)

Cyanobacterial cells or colonies do not usually cause a health problem in drinking-water. They will have been removed from properly treated water. They can interfere with water treatment processes if in large numbers in the raw water, which may lead to other problems.

Their main health problem is the toxins that they can produce. This is discussed in Chapter 9: Cyanobacterial Compliance. See also the datasheets for cyanobacteria and for cyanotoxins.

## 5.4.8 Disease from waterborne pathogens

Drinking-water is an important source of infectious agents, particularly ones that cause enteric infections. Many of the great epidemics of history have been caused by faecal contamination of drinking-water. While person-to-person contact is equally important it is common for the population to indicate water as a source of disease.

The use of chemical disinfectants in water treatment usually results in the formation of chemical by-products. However, the risks to health from these by-products are extremely small in comparison with the risks associated with inadequate disinfection, and it is important that disinfection efficacy not be compromised in attempting to control such by-products (WHO 2017, section 1.1.3, and Ch 3 of these Guidelines).

The significance of any particular organism varies with the disease caused under local water supply conditions. Not all individual members of any population will be susceptible to a pathogenic organism in the water. Waterborne infections will depend on the following:

- the concentration of any pathogenic organism in drinking-water
- the virulence of the strain
- the amount of water taken in by individuals which has not been adequately disinfected
- the minimum infectious dose (MID) of the pathogen in question
- the immune capability or susceptibility of individuals
- the incidence of the infection in a community, thus determining the number of enteric pathogens that would be shed into a potential receiving water source.

Paradoxically, if a particular infection has been received repeatedly from a contaminated water source the community may have become immune to some of the pathogens. This situation develops in countries where the number of pathogens in water is high and the standard of drinking-water is low. Conversely, visitors who drink from such water frequently become ill while the locals have far fewer ill effects. This is a population immunity but it is acquired at the cost of illness and death among children and is not considered acceptable in developed countries.

Where indicators of faecal pollution are found in water the population using that water may not be showing enteric disease. However, the presence of indicators of faecal pollution means that the likelihood of faecal pathogens occurring in that water is high. Continual vigilance is required to determine the need for treatment. If an infection occurs in a community, follow-up epidemiological studies should be carried out such that the source and route of infection can be determined and treated.

The diseases most frequently associated with water are enteric infections such as infectious diarrhoea. In many cases the disease is mild and self-limiting. However, a proportion of the population will suffer more severe outcomes. Several waterborne pathogens such as *Vibrio cholerae*, hepatitis E virus and *E. coli* O157:H7 have high mortality rates.

Since the 1990s evidence that microbial infections are associated with chronic disease started to accumulate. Several waterborne pathogens have been associated with serious sequelae (ie, severe illness or chronic or recurrent disease that appears long after the initial exposure to contaminated water). Examples of sequelae that could potentially be associated with acute waterborne include (WHO 2003c):

- diabetes which has been linked to Coxsackie B4 virus
- myocarditis which has been linked to echovirus
- Guillian-Barré syndrome associated with *Campylobacter* spp
- gastric cancer which has been linked to *Helicobacter* sp
- reactive arthritis which has been linked to *Klebsiella* sp.

## 5.5 Organisms causing problems other than disease

### 5.5.1 General

People in the western world demand water that is free from pathogenic organisms, has a pleasant taste and odour, is colourless and free from toxic chemical substances and corrosive properties. In addition to the pathogenic micro-organisms discussed, waters may also contain (AWWA 2004):

- cyanobacteria (other than those producing cyanotoxins)
- iron, manganese, sulphur and nitrifying bacteria
- actinomycetes and fungi
- large eukaryote organisms such as algae, crustacea, nematodes and protozoa
- insect larvae, eg, the midge and mosquito, usually in storage tanks.

Intermittent problems can occur when some or all of these organisms get into distribution systems where their maintenance or growth is encouraged. Excessive quantities of organic matter will usually support bacteria and fungi that in turn can support protozoa and crustacea. Many eukaryotes (cellular organisms with a nucleus, ie, not including viruses) and invertebrates can then feed on bacteria, fungi and protozoa.

Normally, treated water does not contain sufficient nutrient to support the growth of these organisms. However, the use of any form of filter bed inevitably retains large amounts of organic matter providing substrate and shelter. The filter is therefore an excellent growth medium for bacteria and other organisms higher up the food chain, which feed directly or indirectly on the bacteria. Filter backwashing is used to control this build-up.

Quantitative limits for this heterogeneous group of micro-organisms are not recommended.

## 5.5.2 Organisms causing taste and odour

Unpleasant tastes and smells can result from compounds that are produced by a range of eukaryote micro-organisms. These include protozoa and cyanobacteria. Protozoa from the amoebae and the ciliates are likely to produce odorous compounds. The amoeba of the genera *Vanella*, *Saccamoeba*, *Ripidomyxa*, all of which have bacterial symbionts in their cytoplasm, can produce geosmin or methylisoborneol (MIB). Other sources of the same compounds are cyanobacteria and the actinomycetes. Thus it seems likely that the symbionts of the protozoa are the source of these compounds. Free-swimming ciliates that contain algal symbionts (zoochlorella), including the genera *Stentor* and *Paramecium*, also contribute to odours in water if they reach high numbers.

See AWWA (2004) for discussion on biology, ecology, identification and control strategies. See EA (1998) and EA (2004) for some microbiological and chemical methods for assessing taste and odour problems caused by micro-organisms.

Refer to Chapter 18: Aesthetic Determinands for additional information.

## 5.5.3 Micro-organisms causing colour

Explosive growths of algae, cyanobacteria and other bacteria, can produce unwanted colour in water. *Botryococcus* is one such alga; it can develop high levels of hydrocarbons, which being lighter than water, can result in floating orange blooms. Algal blooms can be controlled by careful application of copper sulphate to the water. If pigmented organisms such as cyanobacteria and algae are crushed on filters to the extent that the cells are disrupted to release pigment, they can create colour. Micro-algae that pass through filters can cause additional turbidity problems.

## 5.5.4 Iron and manganese deposits due to bacteria

A wide range of micro-organisms (bacteria, fungi and sometimes protozoa) can be categorised as chemolithotrophic or photolithotrophic, that is, they are able to oxidise metal salts as part of their metabolism and in doing so cause problems by encrusting pipes, bores or filters. The elements involved in this are mostly iron, manganese and sulphur. The problems are usually identifiable by coloured deposits on equipment. In water containing ferrous or manganese salts, bacteria able to oxidise the compounds can form rust-coloured or black deposits in tanks and on the walls of pipes where the water flow is slow. If the water flow increases, the deposits may be detached to cause colour problems in domestic supplies. The slurry may also contain organic compounds that can break down and produce odour problems. AWWA (2004) discusses the biology, ecology, identification and control strategies.

Manganese-oxidising organisms are responsible for deposits in wells and water pipes and they can reduce yield, clog bore pipes, and reduce flow capacity in water pipes. They may also damage equipment for measuring water flows and produce black-coloured water that can stain in the domestic environment. Bacteria may attach to the deposits and if disturbed will increase a colony count of that water. Prevention is based on the elimination of manganese and iron from raw water if the concentration exceeds 0.1 mg/L iron and 0.04 mg/L manganese.

These chemolithotrophic organisms can impair water quality, but they are usually an intermittent problem and it is therefore not practical to monitor them routinely because of their diverse nature and unpredictable occurrence. Consumer concern or operational problems should be the stimulus for action.

Minimising the problems due to iron and manganese bacteria in groundwater is discussed in Chapter 3: Source Waters, section 3.2.3.4. Methods for removing iron and manganese from water are covered in Chapter 18: Aesthetic Considerations, section 18.3.

## 5.5.5 Corrosion resulting from iron and sulphur bacteria activity

Iron and steel pipes have always been at the mercy of activity by iron and sulphur bacteria. The iron and steel are nowadays often protected with cement or other coatings, or replaced by other materials such as PVC. Microbial corrosion of pipe materials results from:

- depletion of oxygen
- liberation of corrosive metabolites
- production of sulphuric acid
- inclusion of sulphate reducing bacteria in cathodic processes under anaerobic conditions.

Some micro-organisms in water indicate the corrosion of cast iron. Still other micro-organisms can be responsible for the biodeterioration of non-metallic materials such as plastic, rubber and pipelining materials which provide organic nutrients and encourage micro-organism growth, eg, *Pseudomonas aeruginosa* and some coliform organisms (not *E. coli*). Unchlorinated water, or water in which the chlorine demand is high and therefore the chlorine residual has disappeared, supports higher rates of attack than water in which chlorine is still detectable. See AWWA (2004) for further information.

## 5.5.6 Large numbers of micro-organisms

It must always be remembered that water prior to treatment contains a heterogeneous population of micro-organisms. These are mostly aerobic heterotrophic bacteria but their presence may mask the interpretation of a test based on coliform counts, or even restrict their growth, and thus yield false results. A case in point has been demonstrated with strains of *Aeromonas* that produce acid and gas with coliform media at 44.5°C. Control of such micro-organisms is by reduction of the organic carbon source. However, this may not be possible since most catchments have some organic runoff. The less nutrient-rich a water supply is, the better in terms of the reduction of possible micro-organism growth.

Shallow groundwaters often have large numbers of bacteria that grow on general bacteriological media at 37°C, often in the absence of faecal coliforms; total or presumptive coliforms can reach high numbers in these waters too. These are likely to include naturally-occurring soil bacteria. They may also be bacteria from septic tank overflow that has passed through an extensive drainage field where the faecal indicator bacteria have died out or been grazed by larger organisms.

See section 5.3.6 for a discussion on heterotrophic bacteria in water supplies, and Chapter 8: Protozoa Compliance, section 8.5: Challenge Testing, for how measuring the population density of these bacteria can be helpful.

Ainsworth (2004) and Bartrum (2003) discuss the occurrence and control of these bacteria.

## 5.5.7 Invertebrate inhabitants of water systems

Problems caused by the presence of invertebrate animals in large water supplies are uncommon in New Zealand. Poorly operated slow sand filters can give rise to large populations in the distribution system. Invertebrate animals may be present in shallow wells. Such animals derive their food from bacteria, algae and protozoa present in the water or on slime growths or deposits. They include freshwater sponges (the porifera), coelenterates, bryozoans, crustacea, molluscan bivalves, snails and nematodes. Freshwater mussels have caused major problems overseas by blocking pipes. The problems caused by many of these, and control strategies, are discussed in AWWA (2004).

For convenience, the types of organisms can be divided into two sections:

- free-swimming organisms such as the crustacean *Paracalliope* spp (freshwater hopper), *Paranephrops* (freshwater crayfish) and copepods
- animals that move along surfaces or are anchored to them such isopods (water lice), snails, and other molluscs, bryozoans, nematodes and the larvae of chironomids.

In warm weather, slow sand filters can discharge larvae of midges and mosquitoes (eg, *Chironomus* and *Culex* spp) into the water. Such filters may also be heavily infested with adults and larvae of the genus *Psychodidae*. If the top layer of a filter collapses, insect larvae and adults may be drawn down into the unfiltered water. Penetration of invertebrate animals into water supplies through a water filtration plant is much more likely to occur when low quality raw waters are used and where high rate filtration processes are used, especially if the filter depth is less than a metre, or where large sand grains (say more than three mm) have been chosen for the filters. Pre-chlorination destroys the invertebrates and thereby assists their removal by filtration, but promotes increased formation of chlorinated organic compounds. Maintaining chlorine residuals in the distribution system and regularly cleaning mains by flushing can usually prevent infestation.

The removal of isopods and other crustacea from the distribution system has been effected by permethrin treatment of water (in parts of the system that have been isolated) at an average dose not exceeding 0.01 mg/L for 24 to 48 hours. Water treated this way must not be discharged into watercourses as it will be toxic to fish and other aquatic life. Before using permethrin, the proposed procedures should be discussed with the Medical Officer of Health.

Note, however, that adding permethrin directly to drinking-water for public health purposes is not recommended by the WHO, as part of its policy to exclude the use of any pyrethroids for larviciding of mosquito vectors of human disease. This policy is based on concern over the possible accelerated development of vector resistance to synthetic pyrethroids, which, in their application to insecticide-treated mosquito nets, are crucial in the current global malaria strategy.

Renal dialysis units must not be supplied with permethrin-treated water, and those rearing fish should be warned not to replenish their fish tanks with mains water while it is being treated. The treated water can be discharged safely to sewers for treatment at sewage works. In circumstances where such concerns exist, relevant specialist expertise must be sought.

## References

Ainsworth R (ed). 2004. *Safe, Piped Water: Managing microbial water quality in piped distribution systems*. London: IWA Publishing, for the World Health Organization, Geneva. <http://libdoc.who.int/publications/2004/924156251X.pdf>.

Anderson C. 1991. Cholera epidemic traced to risk miscalculation. *Nature* 354: 255.

AWWA. 1999. *Waterborne Pathogens* (1st edition). AWWA Manual M48. Denver CO: American Water Works Association. [Second edition published in 2006.]

AWWA. 2004. *Problem Organisms in Water: Identification and treatment*. Manual of Water Supply Practices, AWWA Manual M7. Denver CO: American Water Works Association.

- Bardsley DA. 1934. The distribution and sanitary significance of *B. coli*, *B. lactis aerogenes* and intermediate types of coliform bacilli in water, soil, faeces and ice-cream. *Journal of Hygiene* (Cambridge) 34: 38–68.
- Bartrum J, et al (eds). 2003. *Heterotrophic Plate Counts and Drinking-water Safety: The significance of HPCs for water quality and human health*. WHO Emerging Issues in Water and Infectious Diseases Series, London, IWA Publishing.  
[http://www.who.int/water\\_sanitation\\_health/emerging/emergingissues/en/index.html](http://www.who.int/water_sanitation_health/emerging/emergingissues/en/index.html).
- Bermúdez M, Hazen TC. 1988. Phenotypic and genotypic comparisons of *Escherichia coli* in pristine waters. *Applied and Environmental Microbiology* 54(4): 979–83.
- Brieseman M, Hill S, Holmes J, et al. 2000. A series of outbreaks of food poisoning? *New Zealand Medical Journal* 113(1104): 54–6.
- Brown MRW, Barker J. 1999. Unexplored reservoirs of pathogenic bacteria: protozoa and biofilms. *Trends in Microbiology* 7(1): 46–50.
- Budd W. 1856. On the fever at the Clergy Orphan Asylum. *Lancet* ii: 617–19.
- Craun GF, Berger PS, Calderon RL. 1997. Coliform bacteria and waterborne disease outbreaks. *Journal of the American Water Works Association* 89(3): 96–104.
- CRC. 2009. *Understanding the Growth of Opportunistic Pathogens within Distribution Systems*. Research Report No. 79. 122 pp.  
[www.waterra.com.au/publications/document-search/?download=110](http://www.waterra.com.au/publications/document-search/?download=110).
- Cursons R, Sleigh J, Hood D, et al. 2003. A case of primary amoebic meningoencephalitis: North Island, New Zealand. *The New Zealand Medical Journal* 116(1187), 5 pages.
- Doyle MP, Zhao T, Meng J, et al. 1997. *Escherichia coli* O157:H7. In MP Doyle (ed) *Food Microbiology: Fundamentals and frontiers*. ASM Press, pp 171–91.
- Dufour AP. 1984. *Health Effects Criteria for Fresh Recreational Waters*. EPA-600/1-84-004. Cincinnati OH: US Environmental Protection Agency.
- DWI. 2010. *Significance of Methods and Sample Volumes for E. coli and Total Coliform Measurements*. Executive Summary (8 pp).  
<http://dwi.defra.gov.uk/research/completed-research/2000today.htm>.
- DWI. 2015. Free-Living Protozoa and Opportunistic Pathogens in Distributed Water. DWI 70/2/223 – Executive Summary. 5 pp.  
<http://dwi.defra.gov.uk/research/completed-research/reports/DWI70-2-223exsum.pdf>.
- DWI. 2015a. *Technical Definition of Wholesomeness in Relation to Water used for Toilet Flushing in Private Water Supplies: Final report*. Report Reference: UC10198.02. 116 pp.  
<http://dwi.defra.gov.uk/research/completed-research/reports/DWI70-2-303.pdf>.
- EA. 1998. *The Assessment of Taste, Odour and Related Aesthetic Problems in Drinking Waters 1998: Methods for the examination of waters and associated materials*. Environment Agency. [http://www.environment-agency.gov.uk/static/documents/Research/171\\_taste\\_odour\\_in\\_water.pdf](http://www.environment-agency.gov.uk/static/documents/Research/171_taste_odour_in_water.pdf).



- EA. 2004. *The Microbiology of Drinking Water (2004) – Part 11 – Taste, Odour and Related Aesthetic Problems: Methods for the examination of waters and associated materials*. Environment Agency. [http://www.environment-agency.gov.uk/static/documents/Research/mdwpart112004\\_859972.pdf](http://www.environment-agency.gov.uk/static/documents/Research/mdwpart112004_859972.pdf).
- Eberhart-Phillips J, Walker N, Garrett N, et al. 1997. Campylobacteriosis in New Zealand: results of a case-control study. *J Epidemiol Comm Health* 51: 686–91.
- Ellis-Pegler R. 2003. Primary amoebic meningoencephalitis – rare and lethal. *The New Zealand Medical Journal* 116(1187), 3 pp.
- FAO. 2003. *Hazard Characterization for Pathogens in Food and Water: Guidelines*. Food and Agriculture Organization of the United Nations and the World Health Organization. 76 pp. [http://www.who.int/water\\_sanitation\\_health/publications/hazard-characterization-forpathogens/en/](http://www.who.int/water_sanitation_health/publications/hazard-characterization-forpathogens/en/).
- Fujioka R, Sian-Denton C, Borja M, et al. 1999. Soil: the environmental source of *Escherichia coli* and enterococci in Guam's streams. *Journal of Applied Microbiology Symposium Supplement* 85: 83S–89S.
- Guzman-Herrador B, Carlander A, et al. 2015. Waterborne outbreaks in the Nordic countries, 1998 to 2012. *Eurosurveillance* 20(24).
- Hardina CM, Fujioka RS. 1991. Soil: The environmental source of *E. coli* and enterococci in Hawaii's streams. *Environmental Ecotoxicology and Water Quality* 6: 185–95.
- Health Canada. 2012. Guidance on the use of heterotrophic plate counts in Canadian drinking water supplies. 21 pp. <http://healthycanadians.gc.ca/publications/healthy-living-vie-saine/water-heterotrophic-heterotrophes-eau/index-eng.php>.
- Health Canada. 2013. Guidance on Waterborne Bacterial Pathogens. 61 pp. [http://www.hc-sc.gc.ca/ewh-semt/pubs/water-eau/index-eng.php#tech\\_doc](http://www.hc-sc.gc.ca/ewh-semt/pubs/water-eau/index-eng.php#tech_doc).
- Hippocrates. 1938. On airs, waters, and places. Translated and republished in *Medical Classics* 3: 19–42.
- Hornick RB, Woodward TE, McCrumb RF. 1966. Study of typhoid fever in man: 1. Evaluation of vaccine effectiveness. *Transactions of the Association of American Physicians* 79: 361–7.
- Houston AC. 1917. *Rivers as Sources of Water Supply*. London: John Bale and Danielsson.
- Hunter P, Waite M, Ronchi E. 2003. *Drinking Water and Infectious Disease: Establishing the links*. Boca Raton: CRC Press, and London: IWA Publishing.
- IAWPRC. 1991. Bacteriophages as model viruses in water quality control. *Water Research* 26(5): 529–45.
- Jofre J, Olle E, Lucena F, et al. 1995. Bacteriophage removal in water treatment plants. *Water Science and Technology* 31(5–6): 69–73.
- Kehr RW, Butterfield CT. 1943. Notes on the relation between coliforms and enteric pathogens. *Public Health Report, Washington* 58: 589–607.

- Küstner HGV, Gibson IHN, Carmichael TR. 1981. The spread of cholera in South Africa. *South African Medical Journal* 60: 87–90.
- Leclerc H, Devriese LA, Mossel DAA. 1996. Taxonomical changes in intestinal (faecal) enterococci and streptococci: consequences on their use as indicators of faecal contamination in drinking water. *Journal of Applied Bacteriology* 81: 459–66.
- LeJeune JT, Besser TE, Merrill NL, et al. 2001. Livestock drinking water microbiology and the factors influencing the quality of drinking water offered to cattle. *Journal of Dairy Science* 84(8): 1856–62.
- Manero A, Blanch AR. 1999. Identification of *Enterococcus* spp. with a biochemical key. *Applied and Environmental Microbiology* 55(10): 4425–30.
- McBride G, Till D, Ryan T, et al. 2002. Freshwater microbiology research report: pathogen occurrence and human health risk assessment analysis. Wellington: Ministry for the Environment. <http://www.mfe.govt.nz/publications/water/freshwater-microbiology-nov02/>.
- Medema G, Bahar M, Schets F. 1997. Survival of *Cryptosporidium parvum*, *Escherichia coli*, faecal enterococci and *Clostridium perfringens* in river water: influence of temperature and autochthonous micro-organisms. *Wat Sci Technol* 35(11–12): 249–52.
- Ministry for the Environment. 2002. *Freshwater Microbiology Research Programme, Pathogen Occurrence and Human Health Risk Assessment Analysis*. Available at: <http://www.mfe.govt.nz/publications/water/freshwater-microbiology-nov02/>.
- Ministry of Health. 2005. *Drinking-water Standards for New Zealand 2005*. Wellington: Ministry of Health.
- Nieminski, et al. 2010. Is *E. coli* an appropriate surrogate for *Cryptosporidium* occurrence in water? *JAWWA* 103(3): 65–78.
- New Zealand Public Health Surveillance Report (NZPHSR)*. 2003.
- OECD/WHO. 2003. *Assessing Microbial Safety of Drinking Water*. Organisation for Economic Co-operation and Development and the World Health Organization. [http://www.who.int/water\\_sanitation\\_health/dwq/9241546301/en/](http://www.who.int/water_sanitation_health/dwq/9241546301/en/).
- Quintero-Betancourt W, Peele ER, Rose JB. 2002. *Cryptosporidium parvum* and *Cyclopora cayetanensis*: a review of laboratory methods for detection of these waterborne parasites. *Journal of Microbiological Methods* 49: 209–24.
- Risebro HL, Breton L, Aird H, et al. 2012. *Contaminated Small Drinking Water Supplies and Risk of Infectious Intestinal Disease: A prospective cohort study*. PLoS ONE 7(8): e42762. doi:10.1371/journal.pone.0042762. Accessed December 2012 at <http://www.plosone.org/article/info:doi/10.1371/journal.pone.0042762?imageURI=info:doi/10.1371/journal.pone.0042762.t005>.
- Sattar S, Chauret C, Springthorpe V, et al. 1999. *Giardia Cyst and Cryptosporidium Oocyst Survival in Watersheds and Factors Affecting Inactivation*. Denver CO: American Water Works Association Research Foundation.
- Schuster RL, Visvesvara GS. 2004. Free-living amoebae as opportunistic and non-opportunistic pathogens of humans and animals. *International Journal for Parasitology* 34: 1001–27.

- Sinton L. 2006. Viable but non-culturable bacteria – menace or myth? *Water and Wastes in New Zealand* 143: 31–8.
- Snow J. 1855. *On the Mode of Communication of Cholera* (2nd edition). London: J Churchill, 162 pp. Reprinted in: *Snow on Cholera*. New York: Hafner, 1965 (1936).
- Stevens M, Ashbolt N and Cunliffe D. 2003. Recommendations to change the use of coliforms as microbial indicators of drinking water quality. 41 pp. NHMRC Publications. <http://www.nhmrc.gov.au>.
- Till D, McBride G, Ball A, et al. 2008. Large-scale freshwater microbiological study: rationale, results and risks. *Journal of Water and Health* 6(4) IWA Publishing.
- USEPA. 2003. *Long Term 2 Enhanced Surface Water Treatment Rule; Proposed Rule*. National Primary Drinking Water Regulations: 40 CFR Parts 141 and 142, 11 August. Now see USEPA (2006a).
- USEPA. 2006a. *National Primary Drinking Water Regulations: Long Term 2 Enhanced Surface Water Treatment Rule: Final Rule* (LT2ESWTR). Federal Register Part II, 40 CFR Parts 9, 141 and 142. Washington: National Archives and Records Administration. See <http://www.epa.gov/fedrgstr/EPA-WATER/2006/January/Day-05/w04a.pdf> <http://www.epa.gov/fedrgstr/EPA-WATER/2006/January/Day-05/w04b.pdf> <http://www.epa.gov/fedrgstr/EPA-WATER/2006/January/Day-05/w04c.pdf> or go to <http://water.epa.gov/lawsregs/rulesregs/sdwa/mdbp/index.cfm> or go to <http://www.epa.gov/lawsregs/rulesregs/sdwa/lt2/compliance.cfm>.
- USEPA. 2013. National Primary Drinking Water Regulations: Revisions to the Total Coliform Rule. *Federal Register* 78(30), Wednesday 13 February 2013, Rules and Regulations. Environmental Protection Agency. 97 pp. <https://www.epa.gov/dwreginfo/revise-total-coliform-rule-and-total-coliform-rule>.
- Victorian Department of Health. 2011. *Public Health Issues Associated with Stock Accessing Waterways Upstream of Drinking Water Off-takes*. 97 pp. Prepared by Water Futures Pty Ltd. <http://docs.health.vic.gov.au/docs/doc/Public-health-issues-associated-with-stock-accessing-waterways-upstream-of-drinking-water-off-takes>.
- WHO. 2001. *Water Quality – Guidelines, Standards and Health: Assessment of risk and risk management for water-related infectious disease*. Published on behalf of the World Health Organization by IWA Publishing. This book is available at: [http://www.who.int/water\\_sanitation\\_health/dwq/whoiwa/en/index.html](http://www.who.int/water_sanitation_health/dwq/whoiwa/en/index.html).
- WHO. 2002. *Evaluation of the H<sub>2</sub>S Method for the Detection of Fecal Contamination of Drinking-water*. WHO/SDE/WSH/02.08. Available at: [http://www.who.int/entity/water\\_sanitation\\_health/dwq/rrh2scom.pdf](http://www.who.int/entity/water_sanitation_health/dwq/rrh2scom.pdf).
- WHO. 2003a. *Heterotrophic Plate Counts and Drinking-water Safety: The significance of HPCs for water quality and the human health*. 256 pp. Published on behalf of WHO by IWA Publishing. Available at [http://www.who.int/water\\_sanitation\\_health/dwq/hpc/en/index.html](http://www.who.int/water_sanitation_health/dwq/hpc/en/index.html).

WHO. 2003b. *Emerging Issues in Water and Infectious Diseases*. ISBN 92 4 159082 3. Available at [http://www.who.int/water\\_sanitation\\_health/emerging/emergingissues/en/index.html](http://www.who.int/water_sanitation_health/emerging/emergingissues/en/index.html).

WHO. 2003c. *Assessing Microbial Safety of Drinking Water: Improving approaches and methods*. [http://www.who.int/water\\_sanitation\\_health/dwq/9241546301/en/index.html](http://www.who.int/water_sanitation_health/dwq/9241546301/en/index.html).

WHO. 2004. *Guidelines for Drinking-water Quality 2004* (3rd edition). Geneva: World Health Organization. Available at: [www.who.int/water\\_sanitation\\_health/dwq/gdwq3/en/print.html](http://www.who.int/water_sanitation_health/dwq/gdwq3/en/print.html) see also the **addenda**.

WHO. 2004b. *Waterborne Zoonoses: Identification, causes and control*. Published on behalf of WHO by IWA Publishing. 528 pp. Available on the internet at: [www.who.int/water\\_sanitation\\_health/diseases/zoonoses/en/index.html](http://www.who.int/water_sanitation_health/diseases/zoonoses/en/index.html) or [www.who.int/water\\_sanitation\\_health/publications/en/index.html](http://www.who.int/water_sanitation_health/publications/en/index.html).

WHO. 2004c. *Pathogenic Mycobacteria in Water: A guide to public health consequences, monitoring and management*. Published by IWA Publishing on behalf of the World Health Organization, ISBN 92-4-156259-5 (WHO), ISBN 1-84339-059-0 (IWA Publishing). Available at: [http://www.who.int/water\\_sanitation\\_health/emerging/pathmycobact/en/](http://www.who.int/water_sanitation_health/emerging/pathmycobact/en/).

WHO. 2004d. *Water Treatment and Pathogen Control: Process efficiency in achieving safe drinking water*. 136 pp. [www.who.int/water\\_sanitation\\_health/publications/en/index.html](http://www.who.int/water_sanitation_health/publications/en/index.html).

WHO. 2004e. *Safe Piped Water: Managing microbial water quality in piped distribution systems*. 168 pp. [http://www.who.int/water\\_sanitation\\_health/publications/safe-piped-water/en/](http://www.who.int/water_sanitation_health/publications/safe-piped-water/en/).

WHO. 2005. *Legionellosis, History and Overview*. Fact Sheet #285 (February 2005). World Health Organization. Available on [www.who.int/entity/mediacentre/factsheets/fs285/en/](http://www.who.int/entity/mediacentre/factsheets/fs285/en/) updated to WHO 2007.

WHO. 2005a. *Preventing Travellers' Diarrhoea: How to make drinking-water safe*. WHO/SDE/WSH/05.07. World Health Organization, Geneva. Available on: [http://www.who.int/water\\_sanitation\\_health/hygiene/envsan/traveldiarrh/en/index.html](http://www.who.int/water_sanitation_health/hygiene/envsan/traveldiarrh/en/index.html).

WHO. 2007. *Legionella and the Prevention of Legionellosis*. Geneva: World Health Organization. J Bartram, Y Chartier, J Lee, et al (eds). ISBN 92 4 156297 8. 276 pp. See: [http://www.who.int/water\\_sanitation\\_health/emerging/legionella.pdf](http://www.who.int/water_sanitation_health/emerging/legionella.pdf).

WHO. 2009. *Risk Assessment of Cryptosporidium in Drinking Water*. WHO/HSE/WSH/09.04. 143 pp. [http://whqlibdoc.who.int/hq/2009/WHO\\_HSE\\_WSH\\_09.04\\_eng.pdf](http://whqlibdoc.who.int/hq/2009/WHO_HSE_WSH_09.04_eng.pdf) or [http://www.who.int/water\\_sanitation\\_health/publications/by\\_date/en/index.html](http://www.who.int/water_sanitation_health/publications/by_date/en/index.html).

WHO. 2011. *Guidelines for Drinking-water Quality* (4th edition). Geneva: World Health Organization. Available at: [http://www.who.int/water\\_sanitation\\_health/publications/2011/dwq\\_guidelines/en/index.html](http://www.who.int/water_sanitation_health/publications/2011/dwq_guidelines/en/index.html).

- WHO. 2011a. *Water Safety in Buildings*. Geneva: World Health Organization. 164 pp. [http://whqlibdoc.who.int/publications/2011/9789241548106\\_eng.pdf](http://whqlibdoc.who.int/publications/2011/9789241548106_eng.pdf).
- WHO. 2012. *Animal Waste, Water Quality and Human Health*. A Dufour, J Bartram, R Bos, et al (eds). Published on behalf of the World Health Organization by IWA Publishing, UK. 489 pp. [http://www.who.int/water\\_sanitation\\_health/publications/2012/animal\\_waste/en/](http://www.who.int/water_sanitation_health/publications/2012/animal_waste/en/).
- WHO. 2014. *Antimicrobial Resistance: An emerging water, sanitation and hygiene issue*. Briefing Note. WHO/FWC/WSH/14.7. 16 pp. [http://www.who.int/water\\_sanitation\\_health/publications/antimicrobial-resistance/en/](http://www.who.int/water_sanitation_health/publications/antimicrobial-resistance/en/).
- WHO. 2016. *Quantitative Microbial Risk Assessment: Application for water safety management*. World Health Organization. Geneva. 208 pp. [http://www.who.int/water\\_sanitation\\_health/dwq/](http://www.who.int/water_sanitation_health/dwq/) or <http://apps.who.int/iris/bitstream/10665/246195/1/9789241565370-eng.pdf?ua=1>.
- WHO. 2017. *Guidelines for Drinking-water Quality: Fourth edition incorporating the first Addendum*. Geneva: World Health Organization. 631 pp. [http://www.who.int/water\\_sanitation\\_health/publications/drinking-water-quality-guidelines-4-including-1st-addendum/en/](http://www.who.int/water_sanitation_health/publications/drinking-water-quality-guidelines-4-including-1st-addendum/en/).
- Widerström, et al. 2014. Large outbreak of *Cryptosporidium hominis* infection transmitted through the public water supply, Sweden. *Emerging Infectious Diseases* 20(4): 581–9. <http://dx.doi.org/10.3201/eid2004.121415>.
- WQRA. 2010. *Health Stream* 58 (June). Quarterly Public Health Newsletter of Water Quality Research Australia. <http://www.wqra.com.au>.
- Yugoslav Typhoid Commission. 1964. A controlled field trial of the effectiveness of acetone-dried and inactivated and heat-phenol-inactivated typhoid vaccines in Yugoslavia. *Bulletin of WHO* 30: 623–30. [http://whqlibdoc.who.int/bulletin/1964/Vol30/Vol30-No5/bulletin\\_1964\\_30\(5\)\\_631-634.pdf](http://whqlibdoc.who.int/bulletin/1964/Vol30/Vol30-No5/bulletin_1964_30(5)_631-634.pdf).

# Chapter 6: Bacteriological compliance

## Contents

|            |  |           |
|------------|--|-----------|
| <b>6.1</b> | <b>Introduction</b>                                  | <b>2</b>  |
| <b>6.2</b> | <b>Monitoring for <i>E. coli</i></b>                 | <b>3</b>  |
| 6.2.1      | General principles                                   | 3         |
| 6.2.2      | Statistical considerations                           | 5         |
| <b>6.3</b> | <b>Microbiological compliance</b>                    | <b>8</b>  |
| 6.3.1      | Introduction   | 8         |
| 6.3.2      | Methods for detecting and enumerating <i>E. coli</i> | 9         |
| 6.3.3      | Effective monitoring programmes                      | 9         |
| 6.3.4      | Monitoring drinking-water leaving a treatment plant  | 11        |
| 6.3.5      | Monitoring drinking-water from groundwater           | 13        |
| 6.3.6      | Monitoring drinking-water in the distribution system | 14        |
| 6.3.7      | Chlorine testing as a substitute for <i>E. coli</i>  | 16        |
| <b>6.4</b> | <b>Sampling and testing</b>                          | <b>19</b> |
| 6.4.1      | Sample handling                                      | 19        |
| 6.4.2      | Test methods and sources                             | 22        |
| 6.4.3      | Laboratory competency                                | 24        |
| <b>6.5</b> | <b>Transgressions</b>                                | <b>25</b> |
| 6.5.1      | Response   | 25        |
| 6.5.2      | Record keeping                                       | 30        |
|            | <b>Appendix: Boil water notices</b>                  | <b>31</b> |
|            | <b>References</b>                                    | <b>32</b> |

## List of tables

|            |  |    |
|------------|--|----|
| Table 6.1: | Example spreadsheet for converting FAC to FACE | 17 |
|------------|--|----|

## List of figures

|             |  |   |
|-------------|--|---|
| Figure 6.1: | Confidence of compliance for a 95 percentile, over smaller and larger datasets | 7 |
| Figure 6.2: | Confidence of compliance for a 98 percentile                                   | 8 |

# 6.1 Introduction

The most common and widespread risk associated with drinking-water is microbial contamination, the consequences of which mean that control of microbiological quality must always be of paramount importance, see Chapter 5 for general discussion.

Microbiology compliance includes, or is related to:

- bacteria – this chapter
- viruses – Chapter 7
- protozoa – Chapter 8
- cyanobacteria – Chapter 9.

Obviously the entire drinking-water supply cannot be tested for compliance, so monitoring programmes must be designed to yield statistically reliable and practical information, see the Appendix in Chapter 1, section 2.4 of Chapter 2, and section 6.2.2. Testing a water supply for verification of microbiological quality must be designed to ensure the best possible chance of detecting contamination. Sampling should therefore take account of potential variations of water quality and increased likelihood of contamination, both at source and during distribution. Faecal contamination usually will not be distributed evenly throughout a piped distribution system. In systems where water quality is consistently good, the probability of missing the detection of faecal indicator bacteria is reduced.

The chances of detecting contamination in systems reporting predominantly negative results for faecal indicator bacteria can be increased by the use of more frequent presence/absence (P/A) testing. P/A testing can be simpler, faster and less expensive than quantitative methods and can maximise the detection of faecal indicator bacteria. However P/A testing is only appropriate for systems where the majority of tests for indicators are negative. Membrane filtration and multiple tube techniques give a numerical result and are preferred.

The more frequently a water supply is tested for faecal indicators, the more likely it is that faecal contamination will be detected. Frequent examination by a simple but reliable method is more valuable than less frequent testing by a complex test or series of tests. The indicator organism of choice for detecting probable faecal contamination is *Escherichia coli* abbreviated to *E. coli*.

*E. coli* monitoring requirements can be replaced or reduced by online measurement of the disinfection process, confirming that it is continuously operating satisfactorily, see section 6.3.7. These operational requirements also need to be monitored, implementing remedial actions when there is a transgression.

By necessity, *E. coli* monitoring is spasmodic. Also it yields results typically 24 hours after sample collection, so produces a historical; record; multiple results give a statistical record. The main reason for *E. coli* monitoring (ie compliance testing) is to determine whether the water supply meets the DWSNZ, implying that the water is safe for consumers to drink. Water safety plans (and these Guidelines) specify the required good management practices.

Section 5.3 in Chapter 5: Microbiological Quality discusses the bacteriological indicators that can be used for demonstrating drinking-water compliance and treatment plant efficacy and the reasons for the choice of *E. coli* as the sole bacterial indicator in the *Drinking-water Standards for New Zealand* (DWSNZ). This chapter addresses questions of compliance with limits set on this indicator. This includes an explanation of how some statistical issues have been addressed in determining the compliance rules, especially rare false positive results.

An important feature of the DWSNZ is the distinction between transgressions and non-compliance. For reasons explained in section 6.2.2, a very small proportion of exceedances of the Maximum Acceptable Value (MAV), ie, transgressions, can be tolerated with the water supply remaining in compliance with the DWSNZ. Nevertheless, preventive and remedial actions are required whenever a transgression occurs. Figures 4.1 and 4.2 in the DWSNZ summarise some of these actions.

The MAV for *E. coli* is less than 1 per 100 mL (Table 2.1 of the DWSNZ). The multiple tube technique used to enumerate *E. coli* reports the most probable number of organisms (or MPN) per 100 mL. For compliance purposes, an *E. coli* result of less than 1 MPN per 100 mL is considered equivalent to less than 1 per 100 mL, or more correctly 1 CFU per 100 mL, where CFU means colony forming unit.

WHO (2004a) discusses treatment processes suitable for pathogen control.

## 6.2 Monitoring for *E. coli*

### 6.2.1 General principles

A microbiologically contaminated drinking-water supply can be a major threat to the health of a community. The main source of this contamination is human and animal faeces. Not only does contaminated drinking-water have the potential to cause significant illness in consumers (as outbreaks, or more commonly, ongoing sporadic cases), it may also be the source of epidemics of disease that spread within the community and have an effect beyond the immediate area supplied with the contaminated water. The provision of safe drinking-water requires that a number of



barriers, including treatment processes, be put in place to minimise faecal contamination of water supplies and any ensuing health effects.

Testing a water supply on a regular basis for *E. coli*, and monitoring the disinfection process, are important steps for detecting whether the barriers being used to provide safe drinking-water and to prevent contamination are likely to have been breached. Note that *E. coli* monitoring should not be used to decide when further water treatment should commence, or processes adjusted, because by the time the alert has been raised by a positive test, a large volume of contaminated water will have entered the distribution system and may have reached some or many consumers. Largely for this reason, the DWSNZ have over recent editions, shifted the emphasis from reliance on compliance monitoring testing more to the implementation of risk management procedures.

To allow reliable detection of barrier failure it is essential that supplies be monitored sufficiently often that any breakdown is detected promptly and remedied as soon as possible. Ideally, water suppliers will have process control monitoring procedures in place that can warn of an impending breakdown; this should be addressed in the WSP.

*E. coli* compliance monitoring will require regular sampling and testing at a frequency and number based on population size. The larger the population served by a water supply, the greater the economic consequence to a community of a contaminated supply. The DWSNZ explicitly cater for population size (for example, see Tables 4.1, 4.2, 4.3, 4.4 and 4.5).

Sampling should be planned to be as effective as possible. Since only continuous monitoring for *E. coli* would give total confidence in the safety of the water (and this is not feasible), sampling must be targeted to give the maximum information. This will be achieved by focusing sampling on the water leaving the treatment plant, and in the case of protozoa, relating sample numbers to the nature of the source water and the number and types of treatment barriers present. The larger the population served by a supply the greater the impact of treatment failure (in terms of the community affected, rather than the individuals affected), and the larger and more extensive the distribution system, the more opportunity there is for a breach in its integrity to occur.

Section 4.4.4 of the DWSNZ refers to the need to collect samples for *E. coli* analysis on different days of the week. This may be difficult for some water suppliers due to isolation, availability of courier services, or the hours the laboratory are open for business. An exemption is permissible, provided the water supplier has conducted a risk analysis that shows that sampling on selective dates does not bias the results. Drinking-water is delivered seven days a week so suppliers need to know that the water quality is equally satisfactory on all seven. This is discussed further in Chapter 17: Monitoring, section 17.2.

If monitoring a water supply for *E. coli* is to have any significant role in preventing people becoming ill from drinking contaminated water, it is essential that there is an immediate response whenever a transgression occurs. As explained in section 6.2.2, a supply can transgress the MAV, yet the supply can still comply with the DWSNZ; this only happens if there are many samples tested and very few transgressions found, and the number of *E. coli* found in a sample is not high. If the only response is to retest, a delay of several days may occur before remedial action is taken and the breach of the

water treatment barriers identified. During that time the community may have been exposed to a significant health hazard from the contaminated water. False positive laboratory results are relatively uncommon, thus a transgression is more likely to suggest a breach to a treatment barrier. For a water supply to be well-managed it is essential that all transgressions be acted upon promptly. Any faecal material that is indicated to be in the water leaving a treatment plant must be of considerable concern to the supply operator because its presence is a clear warning of a system's failure. Small numbers of *E. coli* in a distribution system may pose less of a threat, especially if there is a chlorine residual, and accordingly the response may be less intensive, but high counts (eg, >10 per 100 mL) should be a signal for immediate action.

In all cases where faecal contamination is detected it is very important that a competent person inspect the source water for possible changes, and the treatment plant and/or the distribution system for unexpected breaches. Someone who thoroughly knows the system under investigation should be able to identify problems quickly. Trouble-shooting for anyone, familiar or not with the supply, will always be made easier by the system being clearly documented together with all contingency plans (which should be documented in the WSPs). Abnormalities in the system are much more readily noticed when it is known what should be there and how the system is designed to perform.

Every follow-up of a positive *E. coli* test should be recorded: everything that was observed and done needs to be recorded. This greatly assists later review(s) of the event and assists in the implementation of preventive measures. Repeated systems failure will become apparent sooner, and problems arising from different people, treatment rates, or weather conditions etc being involved at different times are overcome. If the remedial action taken to correct a problem is not written down, no-one can be sure that something was actually done.

## 6.2.2 Statistical considerations

The aim of a monitoring programme must be to give a high degree of confidence that the drinking-water supply is free of contamination. The only way to be 100 percent confident that 100 percent of the water is free of *E. coli* is to submit the entire supply for testing, and this is not feasible, there would be none left for drinking! Furthermore, if a small proportion of the water actually sampled is found to be positive, it may be the result of a false positive phenomenon (eg, contamination during sampling or processing, or detection of a non-faecal particle, or even misreporting), rather than a genuine event. Accordingly, practical compliance rules cannot be derived for 100 percent confidence (ie, certainty) that the supply never transgresses the MAV. This means that statistical methods must be used to develop the rule, accounting for the uncertainties. Two main items must be agreed on before those methods can be employed:

- 1 what percent of the time should the water have no transgressions, even if false positives occur?
- 2 what level of confidence should be attached to that claim? In other words, what is the appropriate burden-of-proof?

The Ministry of Health has a clear mandate in respect of public health to adopt a precautionary approach. Accordingly, in addressing the second issue, the level of confidence should be high; 95 percent has been adopted (as is common for precautionary approaches in the public health field).

For the first issue, the position adopted is that *E. coli*, turbidity, chemicals, disinfection C.t values and UV fluence should not transgress for more than 5 percent of the time. In bacterial compliance criterion 2A, the free available chlorine (FAC) content should not transgress for more than 2 percent of the time. The latter is the more stringent because this compliance criterion can be achieved without any *E. coli* monitoring, and is technologically straight-forward.

It is important to take a sufficient number of samples to be able to be confident in the results. It is also important to recognise the possibility of false positive results and occasional small exceedances of the MAV (ie, transgressions). The DWSNZ accommodate these contrasting requirements by using percentile standards, mostly 95 percentiles.

For important variables that cannot be (or are not) monitored continuously, there is always a risk of failing of making one of two errors:

- failing to detect the proportion of transgressions that actually occur
- detecting a higher proportion of transgressions than actually occur.

Compliance rules for these percentile standards (Table A1.4 in the DWSNZ, and discussed in more detail in the Appendix in Chapter 1) are based on a precautionary approach. To do that, the DWSNZ guard against the first kind of error (often called the consumer's risk). It does this by minimising that risk. This means that the second risk (the producer's risk) will not be minimised, particularly if the supply is truly borderline for compliance (ie, transgressions actually occurred for 5 percent of the time). So the DWSNZ are based on the notion of attaining at least 95 percent confidence of compliance.

This means that if only monthly bacteriological samples are collected in one year and none transgresses the MAV (which is less than 1 *E. coli* per 100 mL of sample), it is only possible to be 70 percent confident that the water is microbiologically safe.<sup>1</sup> Therefore the desired confidence cannot be attained. It is only attained for a 95 percentile when one has tested at least 38 samples, of which none transgressed the MAV. For a 98 percentile one would need at least 95 samples (with no transgressions), before attaining the desired confidence.

Figures 6.1 and 6.2 summarise all these results. It should be noted that these sampling requirements (and those in the DWSNZ editions from 2000) represent a relaxation from those discussed in the 1995 DWSNZ and Guidelines. For example, one needed a minimum of 58 samples (with no transgressions) to achieve 95 percent confidence of compliance with a 95 percentile standard in the 1995 discussion, but only 38 (with no transgressions) in the 2000 DWSNZ. This reduction is because the 1995 set was derived using classical statistical methods, whereas the present standards use Bayesian

<sup>1</sup> The situation is worse still if one of those samples is a transgression; the Confidence of Compliance falls to 20 percent (McBride and Ellis 2001, McBride 2005).

methods. It can be shown (McBride and Ellis 2001) that the classical methods are the most pessimistic of all possible compliance rules, which makes them somewhat inappropriate.

Figures 6.1 and 6.2 show the results of the calculations, from which Table A1.4 in the DWSNZ was derived, see McBride and Ellis 2001 or McBride 2005 for the full details, as summarised in the Appendix in Chapter 1 of the Guidelines).

As an example, reference to Table A1.4 shows that the desired 95 percent level of confidence is obtained when there are 38–76 samples, none of which transgresses the MAV. One transgression is allowed if there are between 77–108 samples. Similarly, if four transgressions occur, a minimum of 194 complying samples is required. These results can be obtained from Figure 6.1, by reading the point at which the curved lines cross the horizontal dashed line, which is at 95 percent confidence of compliance.

Note that in all cases the allowable proportion of transgressions in the samples is less than the DWSNZ requires. For example, allowing one transgression in 100 samples is 1 percent, yet the DWSNZ for Table A1.4 contemplates transgressions for up to 5 percent of the time. This is precisely because a precautionary stance has been taken to the burden-of-proof; it guards against the possibility of finding few transgressions when in fact the supply was in breach of the DWSNZ. So there is a high (~95 percent) probability that the MAV was not exceeded for more than 5 percent of the time if there is only one transgression in 100 samples, and very close to 100 percent confidence if there are none. In other words, the benefit-of-doubt is in favour of the consumer, not the supplier. This is as it should be.

Note too that as the number of samples increases, the proportion of allowable transgressions gets ever closer to 5 percent, eg, for 330 samples, one can have 10 transgressions (over 3 percent). Had a permissive stand been taken the allowable proportion of transgressions among the samples would always be greater than 5 percent.

**Figure 6.1: Confidence of compliance for a 95 percentile, over smaller and larger datasets**

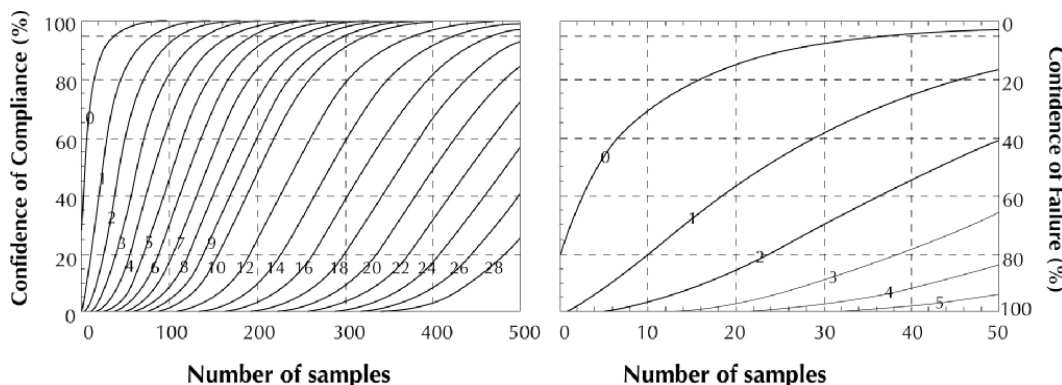

Source: McBride and Ellis 2001 and McBride 2005.

Numbers on the graphs are the observed number of transgressions.

Figure 6.2 has been included for historical reasons, and for interest. The 2008 DWSNZ do not have any instances where 98 percent confidence is required.

**Figure 6.2: Confidence of compliance for a 98 percentile**

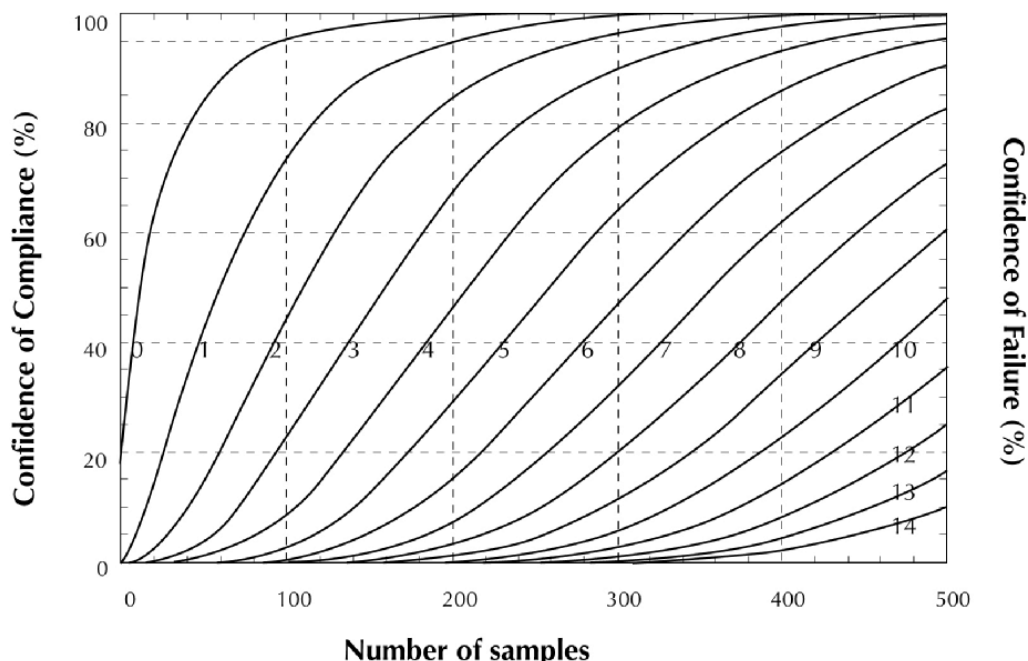

Source: McBride and Ellis 2001 and McBride 2005.<sup>2</sup>

Numbers on the graphs are the observed number of transgressions.

## 6.3 Microbiological compliance

### 6.3.1 Introduction

The DWSNZ require that all water supplies be subjected to microbiological monitoring because microbiological determinands are considered to be Priority 1, ie, determinands of health significance for all drinking-water supplies in New Zealand.

The micro-organisms of most concern are those that are of faecal origin. However, as it would be impracticable to test for the presence of all faecal organisms, or even a selection of pathogens that could be in a contaminated water supply, it has been customary to test for microbiological compliance using indicator bacteria, as discussed in Chapter 5: Microbiological Quality, section 5.3.

However, in recent years it has become apparent that the traditional bacterial indicators of faecal contamination, ie, the faecal coliform or more recently the *E. coli* bacterium, are not good indicators for some viruses or for the pathogenic protozoa, in particular *Giardia* and *Cryptosporidium*, which have been found in some New Zealand surface waters and non-secure bore waters. The protozoa compliance criteria are covered in section 5 of the DWSNZ, and are discussed in Chapter 8: Protozoa Compliance of the Guidelines.

<sup>2</sup> These graphs update the version in the 1995 Guidelines, using Bayesian methods. The 1995 graphs were not Bayesian and so were unduly pessimistic. Furthermore, they contained an error (see McBride and Ellis 2001).

For bacterial compliance in New Zealand, we rely on monitoring *E. coli* as per the DWSNZ, and the implementation of WSPs. In the US, the Surface Water Treatment Rule (SWTR) requires that filtration and disinfection must be provided to ensure that the total treatment of the system achieves at least a 3-log removal or inactivation of *Giardia* cysts and a 4-log removal/ inactivation of viruses. In addition, the disinfection process must demonstrate by continuous monitoring and recording that the disinfectant residual in the water entering the distribution system is never less than 0.2 mg/L for more than four hours. Rather than using a log removal approach for bacteria, or a C.t value approach, the USEPA Total Coliform Rule requires that coliforms be absent.

## 6.3.2 Methods for detecting and enumerating *E. coli*

As discussed in Chapter 5, section 5.3, *E. coli* is now the sole bacterial indicator used in the DWSNZ. A number of the newer methods for testing for coliforms in water test for total coliforms and/or *E. coli*. When these tests are used it is only the *E. coli* result that is sought. Total coliforms have limited interest in their own right, but with one important exception: when total coliforms are detected in the absence of *E. coli*, it is important that the source be investigated as their presence may be indicative of a barrier failure or biofilm development.

The referee methods for testing bacterial compliance are shown in section A2 of the DWSNZ. Presence/absence tests that have been accepted by the MoH for compliance testing are listed in WINZ. IANZ accredited laboratories, and the laboratories that are recognised by the MoH for conducting bacterial compliance testing, can be found on <http://www.drinkingwater.org.nz>, or <http://www.ianz.govt.nz/>.

If a total (or presumptive) coliform method, or a faecal coliform method, is used that does not explicitly enumerate or detect *E. coli*, the results must be considered as equivalent to *E. coli*. Thus if these test results are positive, the action must be as if the test were for *E. coli*. Refer also to Chapter 5: Microbiological Quality, section 5.4.1.

## 6.3.3 Effective monitoring programmes

Maintaining a safe drinking-water supply is dependent on the presence of multiple barriers to reduce contamination and the transmission of pathogens. A monitoring programme is designed to provide an assurance that these barriers are continuing to function and have not been breached. The need for a large number of samples to be tested if a high level of confidence in the integrity of a supply is to be maintained is discussed in section 6.2.2. In addition to the minimum number of samples that are needed for confidence, it will also be important that sampling is carried out at a specified frequency, so that the minimum interval exists between successive samples. This will ensure that breaches to the system are identified soon after they occur. Thus a sampling routine is adopted, eg, once a week, as in the Table 4.2a of the DWSNZ.

It should be noted that not all contamination events are random. Occasionally they may be the result of a cyclic event, eg, management practices at a treatment plant, or an intermittent discharge upstream of the intake. Thus it is important that a sampling routine is randomised. This is most readily done by varying the time of day and the day of the week when regular sampling is performed. Sampling plans must be documented and adhered to; variations may be approved by the DWA. See Chapter 17: Monitoring, section 17.2 for further discussion.

## How to estimate the sampling frequency for water supplies with varying population

All water treatment plants and distribution zones are registered to supply a normal or usual population, which is the population most often found. Some water supply areas experience large fluctuations in population, such as beach resorts, ski fields and camping grounds. The peak population must be estimated and submitted to the DWA with the sampling plan. The sampling frequency should be that required for the higher population for the duration of the higher population, plus at least two weeks before the population is expected to increase. For water supplies that are shut down or operate at a very small fraction of the peak rate, this period may need to be extended to a month. Monitoring before the population increases ensures that there will be time for any treatment process to settle in, and time to remedy any problems that come to light.

## Monitoring stand-by, out-of-service or intermittent supplies

Scheduled samples do not need to be collected while a normally continuous supply is interrupted. However, accurate records need to be maintained so the absence of results from scheduled samples does not result in non-compliance.

Many water suppliers have a water source that is only used occasionally, eg, in the summer, during a drought, or when there is a problem with the regular source. These supplies do not need to be included in the routine monitoring schedules. No monitoring is required while a source or treatment plant is out of service for a period of time, however, the water supplier must ensure by appropriate monitoring that the source is free of *E. coli* or that the plant is operating to its full treatment capability before being placed back on line. Once the source is online, monitoring should proceed, as a minimum at the rate required by the DWSNZ. Compliance is based on statistical considerations and intermittent supplies will not be tested as often. Therefore additional monitoring is recommended while these sources or supplies are operating.

## Monitoring occasional low-level contamination

On some occasions a membrane filtration technique can prove useful because it can increase the detection limit of the *E. coli* test. This can prove helpful in understanding what is going on at some locations such as water treatment plants, service reservoirs or after a mains repair. For example, Rotorua District Council (Charleson, personal communication) found one bulk water supply point occasionally returning faecal

coliforms at 1 cfu/100 mL when using a 100 mL sample, giving rise to the sampler or laboratory being thought of as “having problems”. After analysing 10 litre samples, counts of about 80 cfu per 10 L (0.8 per 100 mL) were obtained at the site of concern, as well as lower levels (20–40 per 10 L) at other supply points, demonstrating that there really was underlying contamination in the source water. Such an approach would not mean that transgressions would occur, because the DWSNZ requires “Less than 1 cfu in 100 mL of sample” for *E. coli* (Table 2.1 of MAVs, DWSNZ). However, in such circumstances, it is certainly advisable to investigate the cause and introduce an appropriate preventive action.

A benefit of this approach is that it dispels the often held belief amongst some water supply staff that zero *E. coli* means the drinking water is sterile! An *E. coli* result as low as 0.1 per 100 mL may still indicate a large number of *E. coli* entering the distribution system; for example one million *E. coli* per 1000 m<sup>3</sup>!

### 6.3.4 Monitoring drinking-water leaving a treatment plant

The DWSNZ consider that there would usually be a greater potential risk to the community if the water entering the distribution system were contaminated than there would be from contamination during distribution. Monitoring the water as it enters the distribution system after the completion of all treatment steps is thus the most critical phase of the monitoring programme. Not only must it be frequent but also the frequency should reflect the nature of the source water and treatment processes and the size of the population drinking the supply (see Table 4.2a in the DWSNZ for presentation of minimum sampling frequencies). Thus the more vulnerable the source water to contamination, the more monitoring of the efficiency of the treatment process and the barriers to contamination there needs to be.

The frequency of *E. coli* monitoring is risk based. A secure bore water requiring no treatment needs only occasional (monthly or quarterly) testing, whereas surface water leaving the treatment plant supplied to populations over 10,000 and using bacterial compliance criterion 1 must be tested daily, Table 4.2a of the DWSNZ. Always bear in mind that the DWSNZ states the *minimum* sampling frequencies required in order to demonstrate compliance.

Water supply operators must always be alert to events that could have a major impact on source water quality or the efficiency of barriers against pathogens. Risk management plans should include an automatic increase in sampling when events occur that could impact significantly on source water quality or the treatment process, eg, high rainfall. For example, see the discussion in Chapter 3: Source Waters, section 3.5.1, that shows how *E. coli* (and presumably many other microbes) are stored in stream sediments during low flows, and occasionally flushed out in much higher concentrations during flood events.



Although there is just the one MAV of less than 1 *E. coli* per 100 mL, section 4.3 of the DWSNZ has established five sets of compliance criteria for water leaving the treatment plant. These are based on the type of disinfection employed, and the more effective the disinfection process, the fewer samples required for testing. The reduced sampling frequency is an attempt to balance risk with the costs of compliance.

Compliance criterion 1 (section 4.3.1 of DWSNZ) applies where there is no disinfection or inadequate disinfection. Also, a water supplier may choose to use solely *E. coli* testing for bacterial compliance, provided they have nominated this in their annual monitoring plan. Sampling frequency is population based and varies from weekly to daily.

Compliance criterion 2 (section 4.3.2 of DWSNZ) applies when chlorine is dosed continuously. Criterion 2A applies when the free available chlorine (FAC) is monitored continuously. Because the efficacy of FAC is pH dependent, pH must be monitored online too, so FAC can be calculated. *E. coli* testing is not required if the criterion 2A conditions are met. Criterion 2B applies when the water is considered to be non-continuously monitored. Sampling frequency is population based and varies from fortnightly to twice weekly.

Compliance criterion 3 (section 4.3.3 of DWSNZ) is the chlorine dioxide equivalent to criterion 2A, where a residual of 0.2 mg/L (as ClO<sub>2</sub>) is considered equivalent to 0.2 mg/L FAC. If there is a chlorine dioxide residual as well as FAC, their concentrations may be added. Compliance criterion 3 also applies, with no additional requirements, if chlorine dioxide disinfection satisfies at least 0.25 protozoal log credits (section 5.14 in DWSNZ).

Compliance criterion 4 (section 4.3.4 of DWSNZ) applies when the water is continuously dosed with ozone, and the continuously monitored C.t value is at least 0.5, eg, a residual of 0.05 mg/L persists for at least 10 minutes. A reduced *E. coli* sampling frequency is allowed in acknowledgement of the disinfecting efficacy of ozone, but because there is no residual, fortnightly sampling for *E. coli* testing is required, regardless of population. Satisfying the protozoal compliance requirements by using ozone (section 5.15, 0.25 log credits or more) automatically achieves bacterial compliance, and no *E. coli* monitoring is required, ie, not compulsory.

Compliance criterion 5 (section 4.3.5 of DWSNZ) applies when UV disinfection is used. If all the protozoal compliance requirements are met when disinfecting with UV light using a dose equivalent to 40 mJ/cm<sup>2</sup> (section 5.16, DWSNZ), bacterial compliance is automatically achieved, and no *E. coli* monitoring is required. For bacterial compliance purposes, UV appliances must have been validated with MS2 organisms or acceptable equivalent, not for example with T1 (see section 5.3 of USEPA 2006). If the UV disinfection appliance is not validated, or any other requirements of section 5.16 are not met, bacterial compliance must be met by using bacterial compliance criteria 1, 2, 3 or 4.

If a water supplier has difficulty meeting compliance criteria 2, 3, 4 or 5, they cannot switch to compliance criterion 1. If routine monitoring finds *E. coli*, or that disinfection is inadequate, Figure 4.1 (in the DWSNZ) applies. This is likely to require additional samples to be collected for *E. coli* testing, which is the response action, not compliance criterion 1. See section 6.5.1 for further discussion.

## 6.3.5 Monitoring drinking-water from groundwater

### a) Demonstrating bore water security

Section 4.5.2 of the DWSNZ specifies the compliance criteria for demonstrating whether bore water is secure. These are discussed in more detail in Chapter 3: Source Water, section 3.2 Groundwater.

- 1 Bore water security criterion 1, section 4.5.2.1, covers demonstrating whether groundwater is affected by surface or climatic influences.
- 2 Bore water security criterion 2, section 4.5.2.2, covers bore head protection.
- 3 Bore water security criterion 3, section 4.5.2.3, covers demonstrating the absence of *E. coli*.

The *E. coli* monitoring requirements depend on the nature of the bore.

If the bore water is from a spring or a groundwater source drawing from an unconfined aquifer that is less than 10 m below the surface, the water is to be considered equivalent to surface water. That means one of the bacterial compliance criteria in section 4.3 of the DWSNZ applies, and one of the protozoal compliance criteria in section 5 applies.

If the bore has satisfied bore water security criterion 1, or is drawing from an unconfined aquifer at least 30 m deep and there is hydrogeological evidence that the bore water is likely to be secure, the bore is given 'interim secure status'. Table 4.5 in the DWSNZ specifies the *E. coli* monitoring requirements for interim secure bore water. Bore water security criterion 3 is satisfied if *E. coli* are absent for 12 months, thereafter sampling can be reduced to the secure bore water rate.

If the bore is drawing water from an unconfined groundwater source that is between 10 and 30 m below the surface, *E. coli* need to be absent during the 5 year monitoring period before bore water security criterion 3 is satisfied, see Table 4.5 in the DWSNZ. During the five-year proving period, one of the bacterial compliance criteria in section 4.3 of the DWSNZ, and one of the protozoal compliance criteria in section 5, must be satisfied. Generally, this is most likely to be achieved by using UV disinfection, or preferably by chlorination plus UV.

Section 4.5.5 of the DWSNZ explains the actions to be followed in the event that *E. coli* are found during the 'proving period'.

### b) Ongoing monitoring of secure bore water

Once security has been demonstrated, the initial sampling frequency for *E. coli* testing for all populations is monthly; this can be reduced to quarterly once a further 12-month period has passed with all samples containing less than 1 *E. coli* per 100 mL, see section 4.5.4 and Table 4.5 of the DWSNZ.

Section 4.5.3 offers reduced *E. coli* monitoring of bores drawing from a common bore field.

Sections 4.3.9 and 4.5.5 of the DWSNZ specify the actions to be followed in the event of *E. coli* been found. Any detection of *E. coli* requires an immediate reassessment of the supply's security status. As well as a sanitary survey and inspection of the bore head, increased *E. coli* sampling is required.

Section 3.2.3.1 in Chapter 3: Source Waters discusses procedures to be followed after events such as major floods and earthquakes. These should be covered in the WSP. Ideally, weekly samples for *E. coli* testing for at least four weeks should be collected whenever the bore water may have been affected due to damage to the confining layer, bore head or adjacent bores.

If the secure bore water receives treatment that could allow microbiological contamination, or is stored uncovered, the water leaving the treatment plant (ie, the water entering the distribution system) must satisfy one of the bacterial criteria in section 4.3. In this situation, proving bore water security offers little advantage.

If a bore water maintains its secure status, it satisfies the bacterial compliance criteria. If it is chlorinated so that FAC can be maintained in the distribution system, there are no additional monitoring requirements for the water leaving the treatment plant such as monitoring FAC concentration, pH or turbidity.

Once bore water (secure or not) enters the distribution system, the bacterial compliance criteria in section 4.4 of the DWSNZ apply.

## 6.3.6 Monitoring drinking-water in the distribution system

The frequency of monitoring of the water in the distribution system will, as for the water leaving the treatment plant, be related to the population size, so that the larger the population receiving the water, the more testing is needed; see Table 4.3a in the DWSNZ. There are two reasons for population-based sampling. One is the number of people at risk from a contaminated supply, and the other relates to the fact that a distribution system serving a large population will usually be more extensive than that for a smaller population, thus there is more opportunity for breaches of the integrity of the system to occur.

It is very important that, when determining the number of samples to be taken for a compliance monitoring programme, managers look closely at the nature and quality of the distribution systems, the population base and fluctuations that do or could occur, and events that could impact on the integrity of the system, eg, very low or very high temperatures (these extremes tend to occur when the main is shallow or is not even buried), pipework maintenance and replacement programmes, land use and development, and retention time or distance.

A sampling programme should not be based simply on the minimum number of samples required for compliance but reflect good management practice (see Chapter 2: Management of Community Supplies) and be specifically designed for each system. It must be reviewed regularly to ensure it still meets its objectives and should be responsive to all types of change.

Section 4.4.3 of the DWSNZ refers to a sampling plan. Table 4.3a shows the minimum number of samples to be collected quarterly. To meet compliance criterion 6A in a zone of 5001 to 10,000 people, at least 16 samples per quarter must be collected which equates to a minimum of 64 samples pa. The compliance monitoring period (CMP) is a year. A water supplier this size that elects to collect the minimum number of samples accepts the risk that a single transgressing sample will result in non-compliance. Had the water supplier decided to collect 20 samples a quarter, they would be allowed one transgression per annum.

In selecting sampling points for the monitoring of a distribution system it is important that the points chosen represent the water being supplied to the consumer and give a comprehensive cover of the network. Points of high draw off should be featured, as should extremities of the system, where deadends occur, and areas where breaches are more likely, eg, service reservoirs, low usage areas where the FAC may have dissipated, old pipework, areas of low pressure, or areas at risk of being excavated.

It is recommended that there be 2–4 times as many sites as the minimum number required, and that these are rotated on a regular basis. At least one site should be sampled every sample round in order to indicate trends, especially if FAC is measured at that site as well. The extra sites will allow good coverage of the distribution system.

Service reservoirs tend to be contaminated more often than water mains, due to both breaches in structural integrity and to dissipation of chlorine residual in low turnover reservoirs. Therefore all service reservoirs should be inspected and sampled at least once during the course of a year, provided they are connected to the supply at the time. If any are only used seasonally, ie, just satisfying peak summer demand, they should be tested before going back on line.

Water suppliers should consider installing special sample taps off a short link from a watermain, rather than using consumers' taps. This will overcome problems such as accidents while flaming, or obtaining a positive result because the (perhaps dirty) tap was not flamed.

The monitoring plan must be documented, ideally as part of or appended to the WSP. The sampling scheduler facility in WINZ may be helpful in designing the monitoring plan.

The bacterial compliance criteria for water in the distribution system are discussed in section 4.4 of the DWSNZ. Criterion 6A applies to the situation when only *E. coli* testing is used. Criterion 6B is for zones supplying a population of over 500 and the water supplier has chosen to substitute FAC monitoring for some of the *E. coli* monitoring; this is discussed further in section 6.3.7.

The DWSNZ also cover bulk distribution zones. These are the parts of the distribution network that deliver water from the treatment plant(s) to one or more distribution zones. Usually, but not necessarily, they are owned and operated by a different water supplier, may or may not include service storage, and services only a nominal number of consumers directly. A bulk distribution zone may be identified due to its operational characteristics, or the characteristics of the water it supplies, by agreement between the water supplier(s) and the DWA. See section 4.4.7 of the DWSNZ for details.

Section 6.4 and section 17.2 of Chapter 17: Monitoring, Water Treatment and Drinking-water, cover sampling.

### 6.3.7 Chlorine testing as a substitute for *E. coli*

Chlorine inactivation of pathogenic bacteria and viruses requires a combination of sufficient contact time and the chlorine concentration at the end of the contact time. Drinking-water with a low chlorine demand will maintain the residual for longer.

The hypochlorous acid molecule (HOCl) is a very effective bactericide and virucide. At alkaline pHs, this dissociates to the hypochlorite ion (OCl<sup>-</sup>) which is not a very effective bactericide. Chlorine becomes increasingly less effective as the pH rises above 8, see Chapter 15: Treatment Processes, Disinfection. The disinfecting power of chlorine in water can be measured by FACE (the FAC equivalent), which is the FAC concentration that would have the same disinfecting power as the chlorine solution would have when adjusted to pH 8.

If chlorine is being used correctly and there is evidence that there is adequate chlorine remaining at the completion of the inactivation step, chlorine monitoring can be used to reduce the *E. coli* monitoring frequency required to satisfy bacterial compliance.

For water leaving the treatment plant, FACE concentrations are measured after a contact of at least 30 minutes, see DWSNZ section 4.3.2. Because water in the distribution system has had a much longer contact time, much of it at a pH less than 8.0, FAC measurements are appropriate.

Experience in New Zealand is that water leaving the treatment plant with a FACE of at least 0.2 mg/L is most unlikely to contain *E. coli*. Likewise, water in the distribution system only very rarely contains *E. coli* if the FAC is over 0.2 mg/L; 0.2 mg/L FAC after 30 minutes retention is equivalent to a C.t value of 6 mg/L.min. A further advantage in allowing substitution is that chlorine test results are available immediately, whereas *E. coli* results take at least 24 hours.

Compliant online chlorine monitoring of water leaving the treatment plant gives a very high level of confidence in the disinfection process. Therefore bacterial compliance criterion 2A allows FACE monitoring in lieu of *E. coli* monitoring, DWSNZ section 4.3.2.1. But because *E. coli* monitoring may be completely substituted, the FACE must be at least 0.2 mg/L for 98 percent of the time.

Bacterial compliance criterion 2B specifies the conditions that will allow a reduced level of *E. coli* monitoring, DWSNZ section 4.3.2.2. Likewise, bacterial compliance criteria 4 and 5 allow reduced *E. coli* monitoring, provided the ozone and UV disinfection processes are compliant, see sections 4.3.4 and 4.3.5. This option was introduced in 2005 because some smaller water suppliers claimed they could not afford to meet all the requirements of continuous monitoring in the time allowed. This option was never considered to be permanent.

Figure A1.1 in DWSNZ shows how much FAC is required to produce 0.2 mg/L FACE at a pH from 8.0 to 9.0. Figure 17.6 in Chapter 17: Monitoring (in the *Guidelines*), shows the percent of undissociated HOCl at a wide range of pHs. These figures are diagrammatic, so it is not possible to use them to convert mg/L FAC to mg/L FACE accurately.

This can be done more accurately using a spreadsheet, eg, Excel, see Table 6.1 for an example. Enter the FAC readings in column A and pH in column B. Copy the following formula and paste into cell C2 to obtain FACE concentrations. The formula is:

$$=IF(B2<8,A2,((A2*(1+((10^(-1*(3000/283-10.0686+(0.0253*283))))/10^(-8)))/(1+((10^(-1*(3000/283-10.0686+(0.0253*283))))/(10^-B2))))))$$

Substitution of chlorine tests for *E. coli* tests cannot be allowed so readily for water in the distribution system. This is because there is less control over the FAC once the water enters the distribution system. If a breach in the distribution system occurs, there will be no way of knowing whether there has been adequate contact time for microbial inactivation to have occurred.

**Table 6.1: Example spreadsheet for converting FAC to FACE**

| Row 1 | Column A<br>FAC | Column B<br>pH | Column C<br>FACE |
|-------|-----------------|----------------|------------------|
| 2     | 1.40            | 9.0            | 0.20             |
| 3     | 1.15            | 8.9            | 0.20             |
| 4     | 0.92            | 8.8            | 0.20             |
| 5     | 0.74            | 8.7            | 0.20             |
| 6     | 0.59            | 8.6            | 0.20             |
| 7     | 0.46            | 8.5            | 0.19             |
| 8     | 0.40            | 8.4            | 0.20             |
| 9     | 0.34            | 8.3            | 0.20             |
| 10    | 0.28            | 8.2            | 0.20             |
| 11    | 0.24            | 8.1            | 0.20             |
| 12    | 0.20            | 8.0            | 0.20             |
| 13    | 0.20            | 7.0            | 0.20             |
| 14    | 0.35            | 6.8            | 0.35             |
| 15    | 0.50            | 8.3            | 0.30             |
| 16    | 0.45            | 9.1            | 0.05             |

For water supplies serving more than 500 people, DWSNZ section 4.4.2 (compliance criterion 6B) allows some substitution of *E. coli* testing of water in the distribution system with chlorine tests, subject to turbidity constraints, and the FAC being generally >0.2 mg/L. Earlier (since 1995) the DWSNZ allowed partial substitution for water supplies serving more than 30,000. The success of this substitution has allowed this approach to be extended. The third addendum to the WHO Guidelines (2008) states in Table 8.27: “a chlorine residual should be maintained throughout the distribution system. At the point of delivery, the minimum FAC should be 0.2 mg/L”.

The DWSNZ state in section 3.1.1: “the DWA must assess the competence of the analyst for commonly-performed plant or distribution system analyses (field tests), refer HDWAA 69ZL e and f, and 69ZP h; analysts must be certified as competent if carrying out compliance testing”.

If free chlorine is the active disinfectant, free chlorine analysers must be used to monitor the disinfection process. Oxidation reduction potential (ORP) meters cannot be used to measure disinfection effectiveness for chlorination. Studies have demonstrated that chlorination effectiveness is not well predicted with ORP measurements and that ORP does not vary in direct proportion to chlorine residual. Furthermore, calculation of residual concentration from measured millivolts can result in large errors of  $\pm 30$  percent (State of Victoria 2013).

Once again, these sampling frequencies are the minimum required to demonstrate compliance; additional process control testing is recommended. Also, a lot can be learned about the distribution system if chlorine is monitored continuously at at least one site.

Bacterial compliance criterion 7B, section 4.4.2 in the DWSNZ, specifies the conditions that allow full substitution of *E. coli* monitoring in bulk distribution zones with online FAC (or chlorine dioxide) monitoring.

The ability of chlorine dioxide to inactivate bacteria is at least as effective as chlorine, and it is not pH dependent. Bacterial compliance criterion 3 allows water leaving the treatment plant to be monitored by online chlorine dioxide measurement in lieu of *E. coli* monitoring, see section 4.3.3 in the DWSNZ. Bacterial compliance criterion 6B allows some *E. coli* tests to be substituted by monitoring the chlorine dioxide residual in the distribution system, see section 4.4.2 in the DWSNZ.

Experience with chloramine disinfection in New Zealand is limited, so the DWSNZ do not allow substitution of *E. coli* monitoring by monitoring chloramine residuals.

Disinfection at the treatment plant with ozone or UV light does not generate a residual that can be carried into the distribution system, so *E. coli* substitution is not allowed there.

## 6.4 Sampling and testing

### 6.4.1 Sample handling

The consequences arising from obtaining faulty samples are serious (eg, declaring that a secure bore water is no longer secure), so the sample collection technique must be thorough. Calling a positive test result a 'false positive' or blaming it on a contaminated sample (ie, the sampler), a frequently used excuse, is not acceptable; the minimum corrective action for this is retraining the staff concerned.

It is possible to include some quality assurance steps in the sampling process. Some water suppliers take a bottle of sterile water on the sample collection run and include it as a control sample with the samples collected. Another technique is to take an empty sterile bottle on the sample run and fill it back in the laboratory with sterile water for testing with samples collected. Another approach is to collect one sample in duplicate on every sample run in order to develop a history of repeatability. Water samplers should always take with them more sample bottles than required so that if there is any suspicion about the integrity of the bottle-filling step, another sample can be collected. Results of QA procedures should be recorded.

Ideally, sample sites should be shown on a sample map, with instructions about how to find them, and must be able to be recognised unambiguously. If the sample is collected from a house or other situation where there is more than one tap, the tap to be used must be indicated clearly.

It is important that the samples of water collected for testing are collected and transported properly. Water samplers must be trained in aseptic technique. If the samples are invalid the subsequent analysis could be a waste of time, and any reporting is likely to be misleading or not accepted. All sample collectors should be trained in the correct procedures (which should have been documented) and should be able to demonstrate their competence. Sample collection is part of field testing, so the DWA will assess the competence of the sampler. Participating laboratories should provide detailed sampling procedure instructions.

All water samples must be identified and labelled clearly. Samples to be included in a monitoring programme should be labelled with a unique number that clearly identifies the sampling site and can be interpreted by anyone familiar with the system for identification of New Zealand water supplies. Sample containers must be labelled on the body of the container not just on a lid, as these may become separated from the water sample during the laboratory analysis. Water suppliers and/or laboratories should specify the sample sites and sampling procedures in a sampling manual. Water suppliers must ensure that all samplers are appropriately trained for compliance monitoring. DWAs assess the competency of individuals performing field tests; sampling procedures are considered to be a field test (or part thereof).



Containers used for collecting microbiological samples must either be sterilised by the laboratory before use or single-use pre-sterilised containers may be used. Laboratory sterilisation requires either one hour at 170°C in a hot air oven for glass containers or 15 minutes in an autoclave at 121°C. A pressure cooker can be used if there is no alternative, but the sterilisation time may then need to be extended and an autoclave indicator used.

The sample containers must have securely fitting stoppers or a leak-free sealing system. Sealing the container must be a straightforward procedure that does not carry a risk of the sample becoming contaminated. Sample containers should be filled leaving sufficient air space for the sample to be thoroughly mixed by shaking before it is tested in the laboratory.

Where chlorine, chlorine dioxide, chloramine or ozone is used as a disinfectant for a water supply, it is important that the residual is neutralised by the addition of sodium thiosulphate to the sample so it does not continue to act. The thiosulphate must be added to the container before it is sterilised. It is not acceptable to add the thiosulphate afterwards, as this may lead to contamination of the water sample. For drinking-waters, 0.1 mL of a 3 percent solution of sodium thiosulphate will neutralise up to 5 mg/L of FAC in a 120 mL sample.

Specially dedicated taps off a short link to a water main can overcome problems of access and flaming. Service reservoirs should also have dedicated taps; if samples have to be collected by dipping, special sampling equipment that can be sterilised must be used. In choosing taps to sample from, avoid those that are leaking or have attachments or hose, unless these are a feature of the drinking-water system.

There is some debate about flaming taps. Taps in pits, valve chambers, etc (if they have to be used) should be flamed because they are likely to be contaminated by road dirt, dogs, etc. If flaming in a pit or valve chamber, check that there are no natural gas mains in the vicinity. Entering valve chambers requires health and safety training. People drink directly from taps in dwellings so, in theory, collecting a sample without flaming represents the drinking-water supply. However, if a fixture contains *E. coli* (eg, splash from dirty napkins on the tap in the washhouse) there is a possibility that the result does not reflect the true condition of the water supply. If taps are unsuitable for flaming then an alternative surface sterilisation is required, such as spraying with 70 percent alcohol or sodium hypochlorite solution, but ensure any residue is well and truly flushed off. A study by DWI (2004) found results for samples taken without prior preparation of the tap showed a number of failures, mostly for total coliforms. In contrast, the results obtained after disinfection of the tap – the normal sampling procedure – resulted in only a single failure (for enterococci).

Open the tap and let the water run to waste for several minutes before taking the sample to represent the water in the system, unless investigating the quality of the first flush or stagnant water in the pipe. When collecting samples for microbiological testing, fill the container without prior rinsing. Sample bottles must be kept closed until they are about to be filled. Take care when opening the container not to contaminate the neck of the container or the inside of the lid or cap with fingers or to make contact with tap or surrounds. Seal the containers carefully, again taking care not to contaminate the sample.

Both empty and filled sample containers must be stored in a clean environment. Empty containers that have not been used should be returned to the laboratory to be resterilised if they become dirty or there is any concern that the seal may have been broken. Devices such as strips of autoclave tape on the necks of bottles may be used as indicators of seal integrity.

Samples must be transported to the laboratory as quickly as possible after collection and should be kept cool and in the dark during transport. Water is not a natural environment for *E. coli*, so they are not expected to increase in numbers in New Zealand unless the water contains the required nutrients and is very warm. Water is such an unattractive environment that *E. coli* are more likely to die than grow. Their metabolic rate is slower in cold water allowing them to remain alive longer.

If transport times exceed one hour the samples should be maintained below 10°C but not frozen. Samples that arrive in the laboratory warmer than 10°C shall not be used for compliance testing unless the temperature of the water has not increased during transit. This can be demonstrated by:

- 1 measuring (and recording) the water temperature at the time of sampling and upon receipt into the laboratory, or
- 2 observing that the ice or coolant used in the container (eg, chillibin) to transport the samples is still frozen and that the sample bottles are packed in a manner that would allow the water sample to cool.

If the water sample has been collected for other tests as well (but obviously not containing sodium thiosulphate), do the microbiological tests first. If samples cannot be processed immediately on their arrival in the laboratory, they must be stored in a refrigerator, at a temperature not exceeding 5°C. The time the samples are processed should be recorded on the laboratory work sheet.

If the above temperature requirements are not satisfied, it may be valid still to process the samples, depending on the bacterial history of the supply and the exact details of sample temperature and transit time. However, the information must be used to modify the sample transport technique.

Normally, the temperature of water samples from a town supply will be very similar on any particular day, simply reflecting seasonal variation. The temperature of many bore water supplies are consistent throughout the year. However, there have been instances where samples have shown atypical temperatures. For example, long service pipes (perhaps feeding back sections) that are shallow or on the surface can produce water that is very warm (even over 40°C) in summer, or approach freezing in winter, and some houses or buildings have small header tanks where the water temperature can be affected by ambient conditions. Water in above ground service reservoirs with very low turnover has reached 32°C. Regrowth is probable at these elevated temperatures. If people are drinking water at atypical temperatures, it must be valid to test these samples. Preferably, the water supplier or property owner will rectify the situation leading to atypical water temperatures.

The laboratory results are probably the most reliable if the test is performed within six hours of the sample being collected. Samples more than 24 hours old should be discarded.<sup>3</sup> Tests performed on such samples cannot be interpreted with any confidence as bacterial counts may increase, decrease, or remain the same, over time. See section 4.3.6 of the DWSNZ. Sometimes it may be impossible to satisfy all the temperature and time requirements so there is an advantage in collecting more than the minimum number specified in the DWSNZ.

## 6.4.2 Test methods and sources

Bacterial compliance monitoring must be conducted by a laboratory recognised by the MoH for that work, see IANZ (2007).

The DWSNZ (Appendix A2.1) have specified the referee methods for testing for *E. coli*, faecal coliforms and total coliforms. These methods are described in *Standard Methods for the Examination of Water and Wastewater*, APHA, 21st edition, 2005 and are already in wide use in New Zealand laboratories.

Non-referee methods are acceptable for water testing provided the performance of the test compared with the referee test is known and there is provision for checking that the test continues to perform satisfactorily and the method has been approved for compliance testing by the Ministry of Health. This can be done either in-house or by regular parallel testing of samples by laboratories using a referee method. See: *The Ministry of Health procedure for approval of new test methods for bacteriological compliance testing of drinking-water samples using presence/absence methods*; <http://www.health.govt.nz/publication/ministry-health-procedure-approval-new-test-methods-bacteriological-compliance-testing-drinking>.

A report was prepared by NIWA (2005) for the Ministry of Health: *A Proposal for Strength of Agreement Criteria for Lin's Concordance Correlation Coefficient*. A simple test is proposed for establishing the equivalence of an analytical method with the referee method for *E. coli* prescribed in the DWSNZ. A concordance calculator enables the strength-of-agreement to be calculated.

Presence/absence tests and tests such as the Colilert and Colisure tests now have international recognition and are approved by the MoH as methods for testing water supplies, have been available for some years and now have been developed to the stage where they are an extremely useful and simple approach for testing water supplies where ready access to a routine laboratory is not available.

<sup>3</sup> There may be some exceptional circumstances where this is not possible, such as sampling remote water supplies where the courier service cannot satisfy the 24-hour requirement. In these circumstances section 4.3.6.1 of the DWSNZ refer readers to section 3.1.1 which states "Special procedures may be authorised in writing by the Ministry for small or remote drinking-water supplies".

Laboratories using presence/absence tests will also need to be able to perform, or get another laboratory to do for them, enumerations when a positive test result occurs. It is essential when problem solving a positive result that there are bacterial counts to allow an estimation of the severity of the problem and to monitor subsequent remedial action, DWSNZ sections 3.1.2 and 4.4.6.

Presence/absence (P/A) tests are unsuitable for testing water supplies known to have *E. coli* problems, as delays in obtaining quantitative results would make problem-solving unacceptably slow.

Whichever method is chosen for detection of *E. coli* or faecal coliforms, the importance of resuscitating or recovering strains that have been sub-lethally damaged by environmental stresses or during drinking-water treatment must be considered.

It is not acceptable to call a positive test result a false positive. False positives can occur, but are rare when using acceptable test methods. If it is believed that some positive P/A test results are false positives (ie, caused by bacteria other than *E. coli*), follow this procedure:

Culture the bacteria growing in the P/A broth on to a selective medium that *E. coli* can be recognised on (eg, EMB agar), isolate and purify each colony type, identify taxonomically each of the isolates and inoculate each pure culture into the P/A test medium. The result is to remain as a transgression unless all of the following conditions are satisfied:

- 1 none of the cultures tested are *E. coli*
- 2 all of the isolates are identified as something other than *E. coli*
- 3 at least one of the isolates gives a positive P/A reaction upon retesting.

*E. coli* can be enumerated by incubation on selective solid media and by incubating a series of inoculated tubes containing selective broths. The former method involves counting positive colonies and reporting the results as the number per 100 mL. The latter technique, the multiple tube technique, reports results as the most probable number (MPN) per 100 mL, and this is obtained by looking up MPN tables. Standard Methods (APHA 2005) offers a fairly restricted arrangement of tubes (numbers thereof and volumes), and therefore a correspondingly small number of MPN tables. The detection limit in their tables is 1.1 MPN per 100 mL, which is greater than the DWSNZ MAV of <1 per 100 mL.

Standard Methods includes an equation (called Thomas' simple formula) for calculating the MPN for when using different volumes or numbers of tubes. Provided more than 100 mL of aliquot is used in the multiple tube technique, the detection limit becomes suitable for bacterial compliance purposes. However, Thomas' simple formula produces approximate results. NIWA has developed a more exact approach using a program called XactMPN (McBride 2003).

Compliance with bacterial compliance criteria 2A and 7B can be achieved by FAC monitoring alone. See Chapter 15: Disinfection, section 15.5.1.3 for a discussion on chlorine measurement.

## 6.4.3 Laboratory competency

The DWSNZ (section 3.1.1) require that water testing laboratories that test water samples for compliance are on the Ministry of Health's Register of Laboratories that have been recognised by the Ministry as competent for the purpose. See Chapter 1: Introduction, section 1.3.10 for a summary of some requirements of recognised laboratories.

The Ministry will require laboratories to identify water samples with the unique drinking-water supply code published in the *Register of Community Drinking-water Supplies in New Zealand*, to be using acceptable methods (Appendix 2 of the DWSNZ), to have adequate documented quality assurance procedures, and to demonstrate that they are competent by satisfactory performance in an inter-laboratory comparison programme.

It is essential that laboratories have documented quality assurance procedures. This does not need to be in the form of very detailed manuals but the basic procedures of the laboratory must be written down. It needs to be quite clear what procedure is being used and exactly how the tests are carried out. All key activities must be documented and everyone involved in testing, from sample collector to the person reporting the results, must have a thorough understanding of their responsibilities and duties, any problems that could arise and how they should be dealt with. All activities undertaken must be recorded so that it is quite clear, from the time of collection of the sample to the reporting of the results, who did what and when.

All laboratories, regardless of size, must be able to demonstrate competence. This means they should be audited independently and ideally, participation in an inter-laboratory proficiency programme. In addition there are a number of other mechanisms for showing competence, eg, spiked samples, split samples, duplicates, positive and negative controls, both within the laboratory and in collaborative tests with other laboratories.

The positive control sample is particularly important. If all the water supply samples give a negative result, this could be explained by all the samples being free of *E. coli*, but equally it could be explained by the test not working. Maybe the incubation temperature was too hot or cold, or maybe there was an inhibitor in the water samples that caused the test not to work. With a positive control sample included in the same batch of samples, this problem is resolved:

- a) if the control sample gives a positive result then the negative tests demonstrate the absence of *E. coli* in the samples that test negative
- b) if the control sample gives a negative sample then the samples giving negative results may also contain *E. coli* that did not grow under the conditions of the test so invalidating the results for that batch of samples.

A negative control sample testing positive suggests contamination of the control sample, of the media or equipment, or handling, or sample identification. If water supply samples in this batch also tested positive, interpretation of results will be difficult.

See Chapter 17 for further discussion.

## 6.5 Transgressions

### 6.5.1 Response

An important aspect of a drinking-water monitoring programme is the response that is made to a transgression. When a sample of drinking-water is found to contain *E. coli* it is essential that there be an immediate response to identify the possible source of the contamination and to implement corrective actions. The minimum response recommended is shown by flow diagrams in section 4 of the DWSNZ, Figures 4.1 and 4.2.

Scheduled compliance sampling and testing must continue through this response phase. Sufficient additional monitoring is required in order to discover the cause of the problem. This means that sampling should be on at least a daily basis. It is not satisfactory to take a sample and then wait for the result of the test before further samples are collected. There must be a series of samples being evaluated over a period of time to give a comprehensive picture of the extent of the problem. The DWSNZ require that at least three consecutive days must be free of positive *E. coli* results before corrective action may be considered to have been successful. This means three days of tests, not tests three days apart!

Water suppliers' WSPs must also document planned responses to events other than failing to satisfy the criteria in the DWSNZ that will obviously lead to a bacterial transgression or non-compliance. These will tend to be supply-specific but will include matters such as dealing with power cuts, running out of disinfectant or failure of the disinfection system or disinfection demand exceeding the maximum dose rate, treatment problems, labour problems, work on the distribution system, commissioning new plant and equipment, breach of security, spills of wastewater or other contamination.

Undisinfected water supplies must include provision for disinfection for times when *E. coli* are found. It is inappropriate to not use chlorine on the grounds of perceived taste/odour problems, or colour/turbidity arising due to oxidation of iron and manganese in groundwater supplies.

The USEPA (2010) published a draft Assessments and Corrective Actions Guidance Manual which includes much discussion and several check lists.

#### a) Response to finding *E. coli* in secure groundwater

This topic has already been discussed in section 6.3.5, which refers to sections 4.3.9 and 4.5.5 of the DWSNZ. Also, read section 3.2 (Groundwater) of Chapter 3: Source Waters for aspects concerning secure groundwater, water quality and bore head protection.

## b) Response to finding *E. coli* in the water leaving a treatment plant

Water suppliers using bacterial compliance criteria 1 and 2B must monitor *E. coli*. Water suppliers using bacterial compliance criteria 4 and 5 in such a manner that protozoal compliance is not achieved also must monitor *E. coli*. Remedial actions for when *E. coli* are found are covered in section 4.3.9 of the DWSNZ.

The detection of *E. coli* in samples taken from water leaving the treatment plant is a major concern to the plant operator as it indicates failure of one or more of the barriers and a major risk to the community of illness from drinking the contaminated water. For the susceptible sections of the population such as babies, the elderly, and those with a number of medical conditions, contaminated drinking-water may, in the absence of major pathogens, still be the cause of significant illness. Thus the supply authority must respond immediately and effectively to the detection of *E. coli* in repeat samples, eg, by additional disinfection and/or issuing a boil water notice (see Appendix, this chapter).

Other conditions may give rise to the need for a boil water notice, such as an increase in the turbidity of the final water after heavy rain, indicating a breakdown in the treatment process, or when the water entering the distribution system is turbid and unchlorinated. Issuing a boil water notice must be considered at an early stage in the investigation and not seen as a last resort when all else has failed. The community's health is paramount and there is a moral obligation for the water supply authority to alert the community to potential hazards. Boil water notices should remain in force until the water supply has returned to a satisfactory quality; however, they are not meant to be a permanent solution to a substandard supply.

The response to possible scenarios should be documented in the WSP. Firstly, see Figure 4.1 and section 4.3.9 of the DWSNZ.

In attempting to discover the cause, records of the previous day's turbidity, pH, and FAC levels in the final water should be examined, as well as the turbidity in the raw water and throughout the treatment process. Check all records of the operation, inspection of disinfectant dosage, and check all relevant calibrations.

If *E. coli* were found in a sample of water leaving the treatment plant the previous day, then that water may still be in the distribution today. This needs to be checked because contamination events that exceed 24 hours can be serious. Knowledge of the distribution system will indicate where the extra sample(s) should be collected. The number of additional distribution system samples that are collected will depend on the results of the inspection of plant records, the size of the distribution system, and the number of *E. coli* present in the sample.

### c) Response to a transgression of an operational requirement

Water suppliers using bacterial compliance criteria 2A, 2B, 3, 4 and 5 for water leaving the treatment plant must monitor parameters related to the performance of the disinfection process being used. These operational requirement tests can include FAC, chlorine dioxide, and ozone concentrations, UV intensity, pH, turbidity, temperature and flow. Remedial actions are covered in section 4.3.9 of the DWSNZ. The DWSNZ allow some leeway with these operational requirements. For example, bacterial compliance criterion 2B requires turbidity to be less than 1.0 NTU for at least 95 percent of the compliance monitoring period; ie, 108 h in 90 days – that is 4.5 days – plenty of time to address a problem before it becomes a non-compliance. However, if this is a recurring problem it may be a design fault which needs to be resolved by improving the treatment process. Or it could be a staff training issue.

Satisfying bacterial compliance criteria 2A and 3, and bacterial plus protozoal compliance with compliance criteria 4 and 5, does not require any routine *E. coli* monitoring, so transgressions must be attended to immediately.

Figure 4.1 in the DWSNZ covers the response to a transgression in drinking-water leaving the treatment plant. Transgressions can result from finding *E. coli*, or finding evidence that the disinfection process is inadequate. Both need immediate action. It is not simply a matter of switching to bacterial compliance criterion 1. Criteria 1 and 2A (etc) are for routine monitoring in normal conditions. But this is not a normal condition – it is a situation with potentially increased risk. The “best” action will depend on the cause of the transgression, the quality of the raw water, etc, i.e. the perceived level of risk. There may well be water supplies where a switch to criterion 1 is appropriate while the problem is being attended to – but at the other extreme, a boil water notice may be advisable! Finding *E. coli* in water leaving the treatment plant is addressed in (b).

The DWSNZ recognise two types of transgression of the disinfection process:

1. when the transgression is a result of the monitoring process. If this happens the DWSNZ require a minimum of twice-daily manual measurement of the disinfectant, pH, turbidity (and flow if required) until the instrumentation is performing satisfactorily. There may be situations where this is not practical. An alternative could be to report the daily plant flow and weight of disinfectant used (or kWhs for ozone or UV) and calculating the daily dose rate and showing that this has continued to meet the disinfection target
2. when the transgression is a result of a disinfection malfunction. This problem needs to be covered in the WSP. Sensibly, and most simply, a WTP would have standby disinfection equipment, or spare containers of chlorine, or supplies of other chemicals, and spare parts for the equipment. Adequate storage, say 24 hours, of treated water is often overlooked too. When a transgression is due to elevated pH causing the FACE to fall below 0.20 mg/L, all that would be required is to increase the chlorine dosage until the FACE is over 0.20 mg/L. If chlorination is impaired by a turbidity transgression, additional *E. coli* sampling may be the most sensible option until the turbidity has returned to normal. These situations are supply-specific; the actions required at a clean mountain stream source will be different from a lowland river source.



A well-managed water treatment plant will have introduced control limits that trigger corrective actions before reaching the transgression level. Potentially useful actions will appear in the WSP. Water suppliers should be encouraged to think about what they have to do to demonstrate that the water is safe to drink, rather than non-compliance.

#### d) Response to finding *E. coli* in the water in the distribution system or zone

Finding *E. coli* in one part of a distribution zone should trigger an immediate search for the source of that contamination. If the level of contamination is high ( $\geq 10$  *E. coli* per 100 mL) the need to warn consumers in the affected areas should be considered.

Where the source of the contamination is found quickly and corrected, there may be no need to alert the community because the hazard no longer exists. However, the drinking-water assessor should still be informed because there has possibly been an opportunity for transmission of waterborne disease. If the source of the contamination is not readily apparent, or is not able to be corrected immediately, the community must be informed.

As with all systems failures, it is important that the failure and the corrective actions are well documented and that sampling regimes remain enhanced until there is complete confidence that the corrective actions have been effective and no recurrence of the failure is likely. This will require consideration of various possibilities.

Firstly, see Figure 4.2 and section 4.4.6 of the DWSNZ. The distribution system can comprise three clearly different components; these are discussed separately below.

#### The water suppliers' local pipework

Say the laboratory reports that *E. coli* has been found in a sample or samples collected the previous day. One of the responses the DWSNZ requires is to resample immediately. This requires some deliberation:

- if the water leaving the treatment plant also contained *E. coli*, and all samples collected that day from the distribution contained *E. coli*, then it is highly likely that there is a large scale public health problem, due to contaminated water or inadequately disinfected water passing through the system
- if the water leaving the treatment plant also contained *E. coli*, but only one sample (of many) from the distribution system contained *E. coli*, then the problem may have existed for only a relatively short period, or that the sampling had just detected the beginning of a large scale problem
- if the water leaving the treatment plant did not contain *E. coli*, and there had been only one sample collected from the distribution system, then it is possible that the cause was due to inadequately disinfected water passing through the system but that the cause (at the treatment plant) was largely diminished by the time the samples were collected; or it could be a spasmodic contamination event in the distribution system

- if the water leaving the treatment plant did not contain *E. coli*, and the one sample with *E. coli* was one of many collected from the distribution system that day, then the problem may be either spasmodic, or the sampling detected the end of a larger scale problem.

Each of these scenarios suggests a different response. The two most practical responses are:

- the minimum resampling should include the sample site that produced the *E. coli*. If the contamination was local, this will show whether the problem still persists
- the previous day's water will now be further through the distribution system and it may still be contaminated. An understanding of the network will indicate the most likely sample sites to check this.

There may be other features or knowledge that suggest a different approach. For example:

- if the FAC level in the positive sample was lower than expected, it may indicate that some dirty water entered the distribution system while it was being repaired, or
- it may indicate that a service reservoir had been releasing water, or
- it may indicate that there had been some water leaving the treatment plant with less FAC than normal, or no FAC, for a while
- if the total plate count of heterotrophic bacteria at the site where *E. coli* were found was higher than usual, it may indicate that contaminated water entered the system; check where the mains repair gang has been operating, or if the Fire Service has been using or testing fire hydrants
- if the FAC level in the positive sample was within the normal range, it is possible that the contamination was very recent and/or very near the sample site.

For discussion on heterotrophic bacteria, see WHO (2003).

Throughout the above discussion, it is assumed that appropriate backflow prevention is in place.

The numbers of *E. coli* found will also suggest different actions. For example, finding several samples with more than say 10 *E. coli* per 100 mL should prompt a much more intensive and urgent response than finding just one sample with 1 *E. coli* per 100 mL.

Each water supply is unique, so the response when finding distribution system samples with *E. coli* should be based on the characteristics of the supply, with due acknowledgement of previous episodes. The various scenarios should be addressed in the WSP so the procedure is documented before the event, and valuable time is not lost.

### Service reservoirs

The response will depend on how the reservoir or tank is operated. Some are in constant use with such a short retention time that the FAC concentration in the water leaving the reservoir is not much lower than that going in.

Some have a very long retention time so that FAC is rarely found in the water leaving the reservoir. Others are only used to maintain pressure in hilly areas during periods of peak consumption. Some have a common inlet/outlet, so some water will be fresh and some old.

Advice on service reservoir design and operations appears in Chapter 16: The Distribution System.

Collecting samples from service reservoirs can be a challenge and may require special techniques and equipment. It is recommended that sample taps be included at the design stage of new reservoirs, and if possible, installed during a shutdown of existing reservoirs.

Finding *E. coli* in a service reservoir is usually a sign that it is not as secure as it should be. Apart from problems arising from poor design, problems can result from contaminated water entering through cracks in the concrete roof, or walls if partly submerged (Kettell and Bennett 1993). Problems can also result from hatches being left open, or being prised open by vandals, or if gaps are big enough to allow birds or other animals (or their wastes) egress. As well as collecting the samples, the water sampler should also inspect the reservoir.

The WSP should include a service reservoir inspection and maintenance programme.

### Bulk distribution zones

The response when finding *E. coli* (compliance criterion 7A) should be as for the water suppliers' local pipework above, except that the previous day's water will now be further through the distribution system and this probably means in another authority's system. The responses that should follow discovery of *E. coli* in a bulk distribution zone should be documented in agreement with the client(s), before *E. coli* are found. A minimum requirement must be to advise the client of the discovery.

If the FAC concentration falls to transgression level (compliance criterion 7B), investigate the cause immediately, see DWSNZ section 4.4.7.5. Possible remedial actions should be anticipated in the PHRPM, and may include: checking records of the FAC leaving the treatment plant, checking chlorine consumption vs flow, recalibrating monitoring equipment.

## 6.5.2 Record keeping

For each water supply there should be a fully documented description of the microbiological monitoring programme. The documentation should include details of the treatment plant and the barriers, the sampling regime and the results of the testing, both routine and non-routine.

The first step in the record keeping process will be to determine how many samples are to be taken, and when. This is decided after evaluation of the nature of the source water, the type of treatment process and the extent and age of the distribution system. This must include separate calculations for the water leaving the treatment plant from that in the distribution system. These calculations should be based on a hazard analysis of the system and identification of any critical points in the process and system where enhanced sampling would provide good assurance of the efficiency of the process, monitoring any weak points in the distribution system, being responsive to external factors that could affect efficiency, etc. Sampling points must be identified clearly and evaluated to give comprehensive coverage of the system.

The results of the routine sampling must be kept in an easily accessible form and must include an automatic alert when transgressions occur. This could be a function of the laboratory undertaking the tests. The laboratories must be provided with clear instructions regarding to whom transgressions are to be reported, and how. Once a transgression is notified the water supplier should follow the procedures documented in the WSP and all outcomes of this response recorded. Water supply managers may wish to include a format for recording the follow-up procedure in the WSP. At the end of a period of non-conformance, the episode should be analysed and the introduction of procedures to prevent a recurrence considered. Action plans must allow for contingencies such as the absence of any staff.

Where a number of transgressions occur, it is essential that a complete evaluation of the water supply occurs to look at how the situation can be improved. In extreme cases this may lead to a recommendation that a source no longer be used or that major improvements to the process and system be implemented to assure compliance with the DWSNZ. The information for making such decisions can only come from well-kept records that give a comprehensive overview of all test results, problems and attempted solutions.

Reporting requirements are covered in section 13 of the DWSNZ.

## Appendix: Boil water notices

Water suppliers need to accept that boil water notices may be needed at some stage to address short-term problems. These need to be considered in advance, ideally as a part of the Water Safety Plan (WSP – formerly known as Public Health Risk Management Plans, PHRMPs). The plan should address:

- the purpose of boil water notices
- which situations should prompt a boil water notice to be issued
- how to handle situations that boil water notices cannot address
- who should initiate, approve, authorise, and release a boil water notice
- who (in the water supply authority) should be informed
- who else needs to be told, including those with special needs
- maintaining a current contact list of all involved, including emergency contacts

- each person’s responsibilities, including those outside the water supply authority
- what the boil water notice should say
- how all those affected shall be informed of the boil water notice
- how to inform those concerned with progress in dealing with the situation
- when an alternative water supply should be provided, and how to do this
- how and whom to advise that the boil water notice has been withdrawn
- procedures for reminding the public if the boil water notice is more than several days
- follow-up procedures to assess performance and improvements.

Health Canada (2015) summarises the factors that should be considered before boil water advisories are issued or rescinded. It provides specific guidance for use during a boil water advisory, including how to properly boil or disinfect water. Health Canada (2009) covers emergencies other than when a boil water advisory is appropriate ie, for when the water supply is contaminated, usually due to chemicals.

See DWI (2012) for a discussion on the effectiveness of different methods of informing the public of the need to boil water.

WHO (2015) states that bacteria are particularly sensitive to heat, and rapid kills – less than 1 minute per log (90%) reduction – are achieved at temperatures above 65°C. Based on these results, it is considered that the process of heating water to a rolling boil, as recommended in the *WHO Guidelines for Drinking-water Quality* (WHO 2011), is sufficient to inactivate pathogenic bacteria, viruses and protozoa. After the water has reached a rolling boil, it should be removed from the heat, allowed to cool naturally, without the addition of ice, and protected from post-treatment recontamination during storage. If turbid water needs to be clarified for aesthetic reasons, this should be done before boiling.

NHMRC, NRMCC (2016) added a six-page Information Sheet to their Australian Drinking Water Guidelines, titled “Guidance for issuing and lifting boil water advisories”.

## References

APHA. 2005. *Standard Methods for the Examination of Water and Wastewater* (21st edition). American Public Health Association, American Water Works Association, Water Environment Federation.

DWI. 2004. *Quality of Drinking Water in Public Buildings*. Report No: DWI 6348. 167 pp. [http://dwi.defra.gov.uk/research/completed-research/reports/DWI70\\_2\\_164\\_public%20buildings.pdf](http://dwi.defra.gov.uk/research/completed-research/reports/DWI70_2_164_public%20buildings.pdf).

DWI. 2012. *Improving Communication on Cryptosporidium and ‘Boil Water’ Notices: Lessons from Pitsford*. Final report to the Drinking Water Inspectorate. 5 pp. <http://dwi.defra.gov.uk/research/completed-research/2000today.htm>.

Health Canada. 2009. Guidance for Issuing and Rescinding Drinking Water Avoidance Advisories in Emergency Situations. 10 pp. <https://www.canada.ca/en/health-canada/services/publications/healthy-living/guidance-issuing-rescinding-drinking-water-avoidance-advisories-emergency-situations.html>.

Health Canada. 2015. Guidance for Issuing and Rescinding Boil Water Advisories in Canadian Drinking-water Supplies. 24 pp. <https://www.canada.ca/en/health-canada/services/publications/healthy-living/guidance-issuing-rescinding-boil-water-advisories-canadian-drinking-water-supplies.html>.

IANZ. 2007. *Supplementary Criteria for Accreditation No. 1.2/2.2: Ministry of Health Register of Water Testing Laboratories* (2nd edition). Auckland: International Accreditation New Zealand, August. See: <http://www.ianz.govt.nz/>.

Kettell D, Bennett N. 1993. *Lyttelton Water Supply: 1992 annus horribilis*. New Zealand Water and Wastes Annual Conference.

McBride GB, Ellis JC. 2001. Confidence of compliance: a Bayesian approach for percentile standards. *Water Research* 35(5): 1117–24.

McBride GB. 2003. *Preparing Exact Most Probable Number (MPN) Tables Using Occupancy Theory, and Accompanying Measures of Uncertainty*. NIWA Technical Report 121, 63 pp. [http://lib3.dss.go.th/fulltext/Journal/J.AOAC%201999-2003/J.AOAC2003/v86n5\(sep-oct\)/v86n5p1084.pdf](http://lib3.dss.go.th/fulltext/Journal/J.AOAC%201999-2003/J.AOAC2003/v86n5(sep-oct)/v86n5p1084.pdf).

McBride GB. 2005. *Using Statistical Methods for Water Quality Management: Issues, Problems and Solutions*. New York: John Wiley & Sons.

Ministry of Health. *MoH Register of Community Drinking-Water Supplies and Suppliers in New Zealand*. Wellington: Ministry of Health. Available at: <http://www.health.govt.nz/water> then select Publications and find the Register.

MoH Register of Recognised Laboratories. Available at: <http://www.health.govt.nz/water> then select Publications and find the Register.

MoH 2005. *Drinking-water Standards for New Zealand 2005* (followed by the 2008 revision). Wellington: Ministry of Health.

MoH 2010. The Ministry of Health procedure for approval of new test methods for bacteriological compliance testing of drinking-water samples using presence/absence methods. <http://www.health.govt.nz/publication/ministry-health-procedure-approval-new-test-methods-bacteriological-compliance-testing-drinking>.

NIWA. 2005. *A Proposal for Strength of Agreement Criteria for Lin's Concordance Correlation Coefficient*. Prepared for the Ministry of Health by GB McBride, NIWA Client Report HAM2005-062. <http://www.health.govt.nz/publication/ministry-health-procedure-approval-new-test-methods-bacteriological-compliance-testing-drinking>.

NHMRC, NRMCC. 2016. *Australian Drinking Water Guidelines 6, 2011*. Version 3.2 Updated February 2016. See Information sheets, pp 246–251. [http://www.nhmrc.gov.au/\\_files\\_nhmrc/file/publications/nhmrc\\_adwg\\_6\\_february\\_2016.pdf](http://www.nhmrc.gov.au/_files_nhmrc/file/publications/nhmrc_adwg_6_february_2016.pdf).

State of Victoria, Department of Health. 2013. Guidelines for validating treatment processes for pathogen reduction: Supporting Class A recycled water schemes in Victoria. In *Information Sheets for Water Treatment Operators submission re NHMRS revision of Drinking-water Guidelines*.

[https://consultations.nhmrc.gov.au/public\\_consultations/submissions/WTO/2562](https://consultations.nhmrc.gov.au/public_consultations/submissions/WTO/2562).

USEPA. 1999. *Alternative Disinfectants and Oxidants Guidance Manual*. EPA 815-R-99-014. 328 pp. <https://www.epa.gov/dwreginfo/guidance-manuals-surface-water-treatment-rules>.

USEPA. 2006. *Ultraviolet Disinfection Guidance Manual for the Long Term 2 Enhanced Surface Water Treatment Rule*. EPA-815-R-06-007. Washington: United States Environmental Protection Agency, Office of Water. Available at: [http://www.epa.gov/ogwdw/disinfection/lt2/pdfs/guide\\_lt2\\_uvguidance.pdf](http://www.epa.gov/ogwdw/disinfection/lt2/pdfs/guide_lt2_uvguidance.pdf) or go to <http://water.epa.gov/lawsregs/rulesregs/sdwa/lt2/compliance.cfm>.

USEPA. 2010. *Proposed Revised Total Coliform Rule. Assessments and corrective actions guidance manual*. Draft. EPA 815-D-10-001. 123 pp. <http://www.epa.gov/safewater/disinfection/tcr/index.html>.

WHO. 2003. *Heterotrophic Plate Counts and Drinking-water Safety: The significance of HPCs for water quality and the human health*. 256 pp. [http://www.who.int/water\\_sanitation\\_health/dwq/hpc/en/index.html](http://www.who.int/water_sanitation_health/dwq/hpc/en/index.html).

WHO. 2004. *Guidelines for Drinking-water Quality* (3rd edition). Geneva: World Health Organization. Available at: [www.who.int/water\\_sanitation\\_health/dwq/gdwq3/en/print.html](http://www.who.int/water_sanitation_health/dwq/gdwq3/en/print.html) see also the addenda.

WHO. 2004a. *Water Treatment and Pathogen Control: Process efficiency in achieving safe drinking water*. 136 pp. [www.who.int/water\\_sanitation\\_health/publications/en/index.html](http://www.who.int/water_sanitation_health/publications/en/index.html).

WHO. 2011. *Guidelines for Drinking-water Quality 2011* (4th edition). Geneva: World Health Organization. Available at: [http://www.who.int/water\\_sanitation\\_health/publications/2011/dwq\\_guidelines/en/index.html](http://www.who.int/water_sanitation_health/publications/2011/dwq_guidelines/en/index.html).

WHO. 2015. *Boil Water*. Technical Brief. WHO/FWC/WSH/15.02. 2 pp. [http://www.who.int/water\\_sanitation\\_health/dwq/Boiling\\_water\\_01\\_15.pdf?ua=1](http://www.who.int/water_sanitation_health/dwq/Boiling_water_01_15.pdf?ua=1).

WHO. 2017. *Guidelines for Drinking-water Quality: Fourth edition incorporating the first Addendum*. Geneva: World Health Organization. 631 pp. [http://www.who.int/water\\_sanitation\\_health/publications/drinking-water-quality-guidelines-4-including-1st-addendum/en/](http://www.who.int/water_sanitation_health/publications/drinking-water-quality-guidelines-4-including-1st-addendum/en/).

# Chapter 7: Virological compliance

## Contents

|       |  |    |
|-------|--|----|
| 7.1   | Introduction   | 2  |
| 7.2   | Health significance of human viruses in drinking-water | 4  |
| 7.3   | Occurrence of human viruses in source waters           | 7  |
| 7.4   | Risk management  | 8  |
| 7.4.1 | International approaches                               | 9  |
| 7.4.2 | Virus removal by current water treatment processes     | 10 |
| 7.5   | Sampling, testing and data interpretation              | 15 |
| 7.6   | C.t values   | 16 |
|       | References   | 20 |

## List of tables

|            |  |    |
|------------|--|----|
| Table 7.1: | UV dose requirements for virus inactivation credit   | 17 |
| Table 7.2: | C.t values for inactivation of viruses by free chlorine, pH 6–9  | 18 |
| Table 7.3: | C.t values for inactivation of viruses by chloramine   | 18 |
| Table 7.4: | C.t values for inactivation of viruses by chlorine dioxide, pH 6–9   | 18 |
| Table 7.5: | C.t values for inactivation of viruses by ozone  | 18 |
| Table 1E:  | Free available chlorine C.t values (mg/L.min) for 4-log inactivation of Coxsackie B5 (CB5) virus calculated by determining the integral of residual chlorine vs time for wastewater of various turbidities and pHs at 10°C | 20 |
| Table 2E:  | Preformed monochloramine C.t values (mg/L.min) for 4-log inactivation of for adenovirus 2 calculated by determining the residual monochloramine vs time for wastewater of various turbidities and pHs at 10°C              | 20 |



## 7.1 Introduction

No maximum acceptable values (MAVs) have been set for human viruses in the *Drinking-water Standards for New Zealand 2005 (revised 2008)*. It is likely that a MAV or MAVs will be established in a future edition. This chapter foreshadows such developments.

In the absence of any MAVs for viruses in the current DWSNZ it should be understood that if they are specifically sought in drinking-water, they should not be detected. If detected, advice should be sought from the relevant health authorities.

Neither the Australian Drinking Water Guidelines (NHMRC, NRMCC 2011) nor the WHO (2011) Guidelines include a guideline value for any viruses. Health Canada (2011) (<http://www.hc-sc.gc.ca/ewh-semt/water-eau/index-eng.php>) has specified a treatment goal of a minimum of 4 log reduction and/or inactivation of enteric viruses.

In the US, the Surface Water Treatment Rule (SWTR) (54 FR 27486, June 29, 1989) applies to all PWSs using surface water or ground water under the direct influence of surface water as sources. It established MCLGs of zero for *Giardia lamblia*, viruses, and *Legionella*, and includes the following treatment technique requirements to reduce exposure to pathogenic microorganisms:

- 1 filtration, unless specific avoidance criteria are met
- 2 maintenance of a disinfectant residual in the distribution system
- 3 removal and/or inactivation of 3-log (99.9%) of *Giardia lamblia* and **4-log (99.99%) of viruses**
- 4 maximum allowable turbidity in the combined filter effluent of 5 NTU and 95th percentile turbidity of 0.5 NTU or less for plants using conventional treatment or direct filtration (with different standards for other filtration technologies)
- 5 watershed protection and source water quality requirements for unfiltered PWSs.

There are more than 140 different types of human enteric viruses that may contaminate potable source waters. These include several important groups: Hepatitis A virus, Hepatitis E virus, norovirus, enterovirus and adenovirus, that have been associated with waterborne illness and are capable of causing severe, and in some cases fatal, infections. Individual datasheets have been prepared for the more important viruses.

Viruses are obligate intracellular parasites, which means they cannot grow or multiply outside their host. Viruses simply consist of a nucleic acid genome (either ribonucleic acid [RNA] or deoxyribonucleic acid [DNA]) surrounded by a protein capsid and, in some cases, a lipoprotein envelope. These viruses are very small, ranging from 20–80 nm (0.02–0.08 micrometres) in diameter; see Figure 4.2 in Chapter 4 to gain a perspective of their size.

Human enteric viruses are present in the gut, respiratory tract and occasionally urine of an infected person, and are discharged with body wastes into wastewater and the environment. Infected people do not always show signs of illness (they are asymptomatic) but they will still produce viruses in their wastes. Specific viruses or strains of viruses are not always present in a community at any one time, but representatives of the large groups (eg, adenovirus or enterovirus) are generally present on most occasions.

Enteric viruses may be found in high numbers in domestic wastewater. Recent New Zealand studies have shown adenovirus and enteroviruses to be present in concentrations greater 10,000 infectious virus units per litre of wastewater (DRG 2002). The number of viruses in wastewater varies with the level of infection in the community but, in general, human viruses will always be present in wastewater, averaging 100–1,000 infectious viruses/L, occasionally reaching very high levels of >10,000 infectious virus/L (Lewis et al 1986). Wastewater treatment processes that do not include a disinfection step may be inefficient in removing or inactivating viruses (<90 percent removal) so viruses may be found in the raw water.

Human enteric viruses cannot multiply in the environment once outside the host. The viruses are characterised by the ability to survive (ie, retain capability to cause infection) for days, weeks or longer, in the environment depending on the type of water, season and other factors (Hunter 1997). In general, as the temperature increases, the survival time decreases. Exposure to UV light (including sunlight) also shortens the survival time of viruses. In a Finnish study (Kauppinen et al 2017) viral genomes of noro- and adenoviruses could be detected in contaminated water samples after being stored at 4°C up to 1277 and 1343 days, respectively.

A large proportion of the human viruses present in source drinking-waters will normally be removed or inactivated by well-operated standard drinking-water treatment processes.

Routine monitoring for viruses in treated water and source water is currently impractical in most situations in New Zealand because of the high cost of sampling and analysis, and problems of detection of a full range of the viruses occurring.

Not all viruses pose a health risk to humans. For example, a pesticide product, *carpovirusine* (see PMEP), contains the active ingredient codling moth granulosis virus (CpGV). This substance appears on the NZFSA's complete database of Agricultural Compounds and Veterinary Medicines (ACVM) as at 2009 (see <https://eatsafe.nzfsa.govt.nz/web/public/acvm-register> and select entire register). It is also approved in many other countries to control codling moth on apples and pears.

National Guidelines for separation distances based on virus transport between on-site domestic wastewater systems and wells have been developed (ESR 2010a). Previous studies using bacterial rather than viral transport as the basis for guidelines is a shortcoming for two main reasons. The survival characteristics of viruses favour their transportation over long distances in aquifers, and their high infectivity means they can cause disease, even though their numbers may have been substantially reduced during transport. The final separation distances given in the Guidelines are based on rotavirus and hepatitis A virus. Rotaviruses were selected because they are among the most infectious viruses and are shed at the greatest concentrations by infected individuals. Many tables are provided, covering a range of vadose zone and saturated zone conditions.

WHO (2006) discusses studies and findings on avian influenza pertaining to water resources, water supplies, sanitation (human excreta, sewerage systems and health care waste) and hygiene. There is a datasheet for influenza viruses.

## 7.2 Health significance of human viruses in drinking-water

Section 11.2 of WHO (2004 and 2011) begin with:

Viruses associated with waterborne transmission are predominantly those that can infect the gastrointestinal tract and are excreted in the faeces of infected humans (enteric viruses). With the exception of hepatitis E virus, humans are considered to be the only source of human infectious species. Enteric viruses typically cause acute disease with a short incubation period. Water may also play a role in the transmission of other viruses with different modes of action. As a group, viruses can cause a wide variety of infections and symptoms involving different routes of transmission, routes and sites of infection and routes of excretion. The combination of these routes and sites of infection can vary and will not always follow expected patterns. For example, viruses that are considered to primarily cause respiratory infections and symptoms are usually transmitted by person-to-person spread of respiratory droplets. However, some of these respiratory viruses may be discharged in faeces, leading to potential contamination of water and subsequent transmission through aerosols and droplets. Another example is viruses excreted in urine, such as polyomaviruses, which could contaminate and then be potentially transmitted by water, with possible long-term health effects, such as cancer, that are not readily associated epidemiologically with waterborne transmission.

Hepatitis A virus, Hepatitis E virus, norovirus, enterovirus adenovirus and rotavirus may occur in drinking-water where they are present in the source water and when water treatment does not remove them completely. Very few human enteric viruses (1–50 virus particles depending on type) are required to produce an infection in a susceptible person (Hunter 1997; Teunis et al 2008). The symptoms generally attributed to enteric viruses are gastroenteritis and diarrhoea but they can also cause hepatitis, respiratory, central nervous system, liver, muscular and heart infections. Some waterborne viruses have also been associated with some forms of diabetes, chronic fatigue syndrome and dementia (Nwachuku and Gerba 2004; Ashbolt 2004; Klemola et al 2008). The major groups of viruses contaminating water are discussed below but may not represent all the viruses likely to be transmitted by water. It is reasonable to expect that further important groups of waterborne viruses will be detected in the future and that these will most likely cause atypical waterborne disease (Nwachuku and Gerba 2004; Ashbolt 2004). In general, viruses are host specific, so viruses that infect animals or plants do not usually infect humans, although a small number of enteric viruses have been detected in both humans and animals. There are more than 140 enteric viruses known to infect humans.

**Norovirus:** this group of caliciviruses includes the Norwalk and Norwalk-like viruses. Noroviruses are currently subdivided into seven genogroups (GI to GVII), which are composed of more than 40 distinct genotypes. Members of this group are strongly associated with waterborne outbreaks in many parts of the world. Symptoms of infection are self-limiting and include vomiting, diarrhoea and nausea over 24–48 hours. Norovirus is quite prevalent in New Zealand and is responsible for a large proportion of viral gastroenteritis reported to health authorities (ESR 2004). This virus is one of the easiest to link to a common source outbreak as the symptoms occur rapidly after contact with the virus (approximately 24 hours). More than 200 people developed acute gastroenteritis in July 2006 when sewage contaminated the water supply (which had inadequate treatment) at a South Island ski resort. The illness was caused by norovirus genogroup GI-5 (Hewitt et al 2007).

**Hepatitis A and E:** Hepatitis A and E have a relatively low occurrence in New Zealand (ESR 2004) but induce quite significant symptoms including fever, malaise anorexia and jaundice. The disease caused by these viruses is essentially clinically indistinguishable and is generally self-limiting but has a 1 to 2 percent mortality rate. The infectious doses for these viruses are relatively low (10–100 viruses) and symptoms do not occur until 10–50 days after infection. Internationally Hepatitis A and E outbreaks have frequently been associated with water (Kasorndorkbua et al 2005; Meng 2005; Vasickova et al 2005; Kuniholm et al 2009). The other hepatitis viruses appear not to be transmitted via the faecal–oral route.

**Enteroviruses and adenoviruses:** these two different groups represent the viruses (over 300) that are most commonly found in contaminated surface water (Ashbolt 2004). These viruses produce a very broad range of symptoms including respiratory, skin and eye, nervous system, liver, heart and muscular systems. Gastroenteritis with vomiting and diarrhoea is a less common outcome of infection with these viruses and is limited to only a few adenovirus and enterovirus types. Reported waterborne outbreaks of these viruses, other than in swimming pools, are very infrequent. It is not clear whether lack of reporting is because the dominant symptoms produced by these viruses are not those traditionally associated with water or food borne disease, or because such outbreaks are indeed rare (Hunter 1997). Enteroviruses include the polioviruses, echoviruses and coxsackieviruses A and B. Adenovirus is the most UV resistant virus known (Linden and Sobsey 2005). Coxsackie B5 (CB5) is an enterovirus known to be highly resistant to chlorine in wastewater of varying turbidity, and Adenovirus 2 is a respiratory virus known to be highly resistant to monochloramine, in wastewater of varying turbidity (Keegan et al 2012).

**Rotavirus:** rotavirus has been detected in sewage, rivers and lakes, and treated drinking-water. Transmission occurs via the faecal-to-oral route. Cases of infection tend to be sporadic but several waterborne outbreaks have been reported (Gratacap-Cavallier et al 2000; Parashar et al 2003; Amar et al 2005). Rotaviruses are responsible for a large proportion of severe episodes of diarrhoea in small children and infants, and they also cause gastroenteritis in the elderly. They are responsible for as much as 50 percent of the gastroenteritis in hospitalised paediatric patients during the cooler months of the year in temperate climates (Parashar et al 2003). Acute infection is characterised by the abrupt onset of severe watery diarrhoea with fever and vomiting. Dehydration and metabolic acidosis may develop, resulting in death if untreated. Children aged 6 to 24 months are the most severely affected. Rotaviruses are ubiquitous, infecting over 90 percent of all children up to three years of age internationally (Pérez-Vargas et al 2006; Brooks et al 2007). New Zealand, however, does not have a human rotavirus surveillance programme so the prevalence of rotavirus and its disease burden cannot be estimated.

**Astroviruses:** astroviruses are members of the *Astroviridae* family. They are divided into eight serotypes (HAst1-8); novel types continue to be discovered. Astroviruses comprise two genogroups (A and B) capable of infecting humans. Astrovirus infection typically results in diarrhoea lasting 2–3 days, with an initial incubation period of 1 to 5 days. Infection generally results in milder diarrhoea than that caused by rotavirus and does not lead to significant dehydration. Other symptoms that have been recorded as a result of astrovirus infection include headache, malaise, nausea, vomiting and mild fever. Healthy individuals generally acquire good immunity to the disease, so reinfection is rare. Astrovirus infections generally peak during winter and spring.

**Ebola virus:** Ebola virus is not likely to be found in New Zealand so a datasheet has not been prepared. WHO (2014 and 2016) provided the following. Ebola virus belongs in the Filoviridae family. Ebola is transmitted through direct contact with blood or bodily fluids of an infected person or animal, and is not transmitted through air, water or sewage. The characteristics of the Ebola virus suggest that it is likely to be relatively fragile in the environment in comparison with the enteric viruses that commonly cause diarrhoeal disease. To date, there is no evidence for transmission of Ebola viruses via drinking-water contaminated by faeces or urine. The virus is unlikely to survive for extended periods outside of the body. Higher temperatures (room temperature or above) are likely to increase the speed at which the virus dies off in the environment. There is no evidence to date that Ebola has been transmitted via sewerage systems, with or without wastewater treatment. Current thinking is that Ebola survives in water for only a matter of minutes. Once in water, the host cell will take in water in an attempt to equalise the osmotic pressure, causing the cells to swell and burst, thus killing the virus. WRA (2014) states that based on current knowledge, water supplies which receive an adequate level of treatment and disinfection to remove the common human enteric viruses are not likely to pose any risk of transmission of the Ebola virus – even if the raw water contains faecal contamination from Ebola cases. At a WHO Workshop results of a study on the persistence of Ebola virus in sterilised wastewater were presented: the virus titre declined by approx. 99% after 1 day with declines thereafter lower than this.

Health Canada (2017) discusses some potential emerging viruses in drinking water.

Virus infections resulting from correctly treated water have not been reported in New Zealand (ESR 2004), although internationally such outbreaks are recognised (Hunter 1997; Hrudehy and Hrudehy 2007). Human viruses have been reported to occur at very low levels (0.1–1/100 L) in conventionally treated drinking-water in many countries (Vivier et al 2004) including New Zealand (Kim 2005).

Estimations of viral disease risk using standard risk assessment techniques with a high infectivity virus predict the surprisingly high annual risk of infection of between 1:3 and 1:25 from conventionally treated drinking-water contaminated by viruses at low levels (~1 virus per 100 litres) (Gerba and Rose 1992).

Viruses and phages are also discussed in Chapter 5: General Microbiological Quality, sections 5.3.4 and 5.4.4. More detailed discussion appears in the datasheets.

## 7.3 Occurrence of human viruses in source waters

The New Zealand freshwater microbiology study (Till et al 2002) is the most significant study of human virus's occurrence in surface water in New Zealand to date. This study carried out in collaboration between the Ministries for the Environment, Agriculture and Forestry, and Health tested recreational water locations on 25 rivers and lakes every two weeks for 15 months.

Human adenovirus and/or enterovirus were detected, by qualitative molecular methods, in more than 50 percent of the 275 samples collected. These data suggest that human virus occurs quite frequently in surface waters and in a wide range of source water locations and types.

Subsequent culture based studies of virus occurrence in the Waikato River showed that adenovirus and enterovirus levels are generally low, less than 5 per 100 L, but on some occasions may be as high as 10 per 100 L (Watercare Waikato River Monitoring studies 2003–2004).

Studies using sensitive qualitative molecular-based virus detection methods suggest that adenovirus occurrence may be 10 times higher than this level on some occasions in the Waikato River (Kim et al 2005) although it is not clear whether all of these viruses are able to produce infections.

International data collated by WHO suggest that typical surface source waters may contain 0–10 viruses per litre (WHO 2004).

A UK study (DWI 2013) of the occurrence of adenovirus (AdV), norovirus (NV), plus several chemical determinands in raw waters found none of the chemical and microbiological parameter measurements gave useful indications of the levels of viruses. But there was strong evidence of an association between NV and AdV in raw water. However AdV was frequently detected in the absence of NV.

Health Canada (2017) reports studies where enteric viruses have been found in groundwater samples that did not contain indicator bacteria. For example, a study of private wells in the US found that 8% of the wells tested by polymerase chain reaction (PCR) were positive for one or more enteric viruses, however, none of the contaminated wells contained indicators of faecal contamination (ie, *E. coli*, enterococci, coliphages), and only 25% of the virus-impacted wells were positive for total coliforms.

## 7.4 Risk management

Potential for disease outbreaks associated with human virus contamination of source waters, and the potential to carry over to treated drinking-water is recognised throughout the developed world. Approaches to controlling the risks are largely through protection of source water quality by control of human activity in reservoir catchments, and through adequate treatment and disinfection of drinking-water. It is now well accepted that bacterial indicators such as *E. coli* are not necessarily adequate surrogates of viral occurrence. Human viruses tend to be more resistant to environmental stresses and water treatment mechanisms than are bacterial indicators, so the absence of the indicator may not equate with absence of the virus contaminant.

## 7.4.1 International approaches

The paucity of knowledge on the specific occurrence of human viruses in source waters, and the problems of virus detection and regular monitoring, mean that most guideline documents include only the qualitative requirement that, if tested for, human viruses should not be detected in treated drinking-water.

Where virus guidelines or standard requirements are in place these are stated either in terms of virus occurrence, or as water treatment plant virus removal efficiency. Such values are either derived from acceptable levels of health risk or, pragmatically, reflect virus detection capability.

Recent standard and guideline recommendations have moved towards risk-based evaluation of water treatment requirements. The USEPA Surface Water Treatment Rule includes a virus treatment requirement and requires that treatment of both filtered and unfiltered water sources is sufficient to remove or inactivate 99.99 percent (4 log) of viruses (USEPA, SWTR). This requirement is principally based on the acceptable (USEPA 1994) level of waterborne illness in a community (one case per 10,000 consumers) and the likely level of viruses in surface water.<sup>1</sup> Recent US proposals for surface water disinfection (USEPA 2003/2006a) use the adenovirus group as the target virus.

The WHO Guidelines recognise that water treatment requirements will differ for different communities, and propose a risk-based approach for setting performance targets for surface water treatment plants (WHO 2004/2017).

The risk-based approach takes into account a broad range of factors including virus occurrence and infectivity, water type, community health status and treatment characteristics. Such an approach requires a detailed knowledge of the water supply, water treatment performance and community activities and health status.

Approaches to managing viruses in treated water also recognise that the greatest health risk to a community occurs when water treatment conditions are atypical such as when source water condition is unusual, very high levels of virus occur, or through poor performance, or even failure, within the water treatment process.

Health Canada (2017) proposes a guideline:

The proposed guideline for enteric viruses in drinking water is a health-based treatment goal of a minimum 4 log removal and/or inactivation of enteric viruses. Depending on the source water quality, a greater log reduction may be required. Methods currently available for the detection of enteric viruses are not feasible for routine monitoring. Treatment technologies and watershed or wellhead protection measures known to reduce the risk of waterborne illness should be implemented and maintained if source water is subject to faecal contamination or if enteric viruses have been responsible for past waterborne outbreaks.

<sup>1</sup> In the Drinking-Water Contaminant Candidate List 3 – Draft in the Federal Register: 21 February 2008, 73(35); <http://www.epa.gov>.



## 7.4.2 Virus removal by current water treatment processes

Reduction of virus numbers in water as a result of treatment can occur through either virus removal or virus inactivation. Each virus type may react somewhat differently to particular water treatment methods, but the bulk of research to-date suggests that some broad generalisations can be made. WHO (2004a) discusses treatment processes suitable for pathogen control.

Virus removal can occur by physical association of a virus with other particles. Virus association with particles may be enhanced by addition of coagulants to form a floc, which can then be removed by settlement and/or filtration. The extremely small size of viruses means that they are unlikely to be removed if they are not associated with other particles. Water treatment processes such as flocculation, sand filtration, microfiltration and ultrafiltration, and prolonged standing in reservoirs, will result in physical removal of particle-associated viruses. Only reverse osmosis and dialysis membranes have pore sizes small enough to trap virus particles that are not associated with larger particles or flocs.

The effectiveness of virus removal is affected by those factors that act against particle association or floc formation including water condition and pH (LeChevallier and Au 2004).

Virus inactivation occurs through disruption of the external protein coat (capsid), modification of specific surface sites needed for infection (host receptor recognition sites) or major change to the nucleic acid (RNA or DNA). Disinfectants such as chlorine, chlorine dioxide, and ozone will cause disruption of the virus coat and of the exposed nucleic acids (Shin and Sobsey 2003, Tree et al 2003). Ultraviolet light in the range of 200–310 nm (antimicrobial range) will disrupt the nucleic acids by causing cross-linking, leaving viruses unable to replicate.

Viruses can differ greatly in their ability to resist various disinfectants. For example, it is widely regarded that double-stranded DNA viruses such as adenoviruses are more resistant to UV disinfection than single-stranded DNA viruses or RNA viruses.

Viruses can also be inactivated by prolonged holding in reservoirs that are exposed to sunlight, elevated temperature and extremes of pH, eg, lime treatment (Sobsey 1989). Different virus types and strains will show different levels of resistance to chemical or physical inactivation. Adenoviruses are considered to be the most resistant virus group to many disinfection treatments, because of their structure and nucleic acid makeup, and have been used by the USEPA as a model virus for designing UV criteria for surface water treatment (USEPA 2003/ 2006a).

The potential for virus inactivation by disinfectants is reduced by the presence of other particles or organic matter that will consume disinfectants or of light adsorbing or blocking materials that reduce UV penetration (LeChevallier and Au 2004).

Repair of disinfection damage is unlikely to occur in viruses as they do not appear to have repair mechanisms. It has been suggested that some viruses (such as the double stranded DNA adenoviruses) may be able to repair their DNA, and if there is no damage to the virus coat, they are still able to infect a host cell (Nwachuku and Gerba 2004).

Water treatment plants will normally include both virus removal and virus inactivation processes that act as multiple barriers.

Studies conducted in the 1980s using cell cultures to detect cytopathic effects (CPE) to assay infective viruses indicated that well-operated conventional water treatment removed 2-logs of viruses, and disinfection with chlorine could readily achieve a further 2-logs reduction. These studies also indicated that finished water produced by well-operated conventional treatment and disinfection was usually free of infective viruses as judged by examination of large volumes by the cell culture/CPE assay method. A target of 4-logs of virus reduction for surface waters was adopted by the USEPA in 1989 and has become the de facto benchmark for water treatment in other developed nations even if not formally stated in their standards or guidelines. More recent research indicates that the definition of a 'well-operated' conventional water treatment needs to be reassessed. Studies indicated that control of the coagulation/sedimentation/filtration process is critical for pathogen removal, and that implementation of an operational target of 0.2 NTU or less for turbidity for individual filtration units is needed to ensure optimum virus removal (2.0 to 2.5 logs). Operation at higher turbidity levels, but still well below the traditionally accepted figure of 1 NTU, may achieve only minimal virus removal (less than 0.5 log), and greatly diminishes the effectiveness of the filtration barrier. The target of 0.2 NTU or less also provides enhanced removal of other pathogen classes (taken from the executive summary of *Strategic Review of Waterborne Viruses*, Occasional Paper 11, CRC for Water Quality and Treatment).

Waterborne outbreaks of viral disease have been recorded mainly in groundwater systems where no disinfection or treatment to remove pathogens has been routinely practised. In instances where viral outbreaks have occurred in disinfected water supplies, investigations have revealed either a failure in disinfection, or unusually high levels of contamination in source waters which overwhelmed the disinfectant dose being applied. Therefore, provided that adequate control and monitoring of treatment and disinfection processes is being implemented, well-operated conventional water treatment and disinfection will provide an effective barrier against such outbreaks. Epidemiological studies of the possible contribution of pathogens in conventionally treated drinking-water to endemic gastroenteritis have given mixed results; however a study of robust design conducted in the USA found no evidence that waterborne pathogens made a detectable contribution to gastroenteritis in a city served by a stringently operated conventional water supply system (taken from the executive summary of *Strategic Review of Waterborne Viruses*, Occasional Paper 11, CRC for Water Quality and Treatment).

Virus removal and inactivation efficiencies for a range of water treatment processes are reviewed in the WHO (2004) Guidelines (Chapter 7), and by LeChevallier and Au (2004). WHO (2015) stated that viruses are inactivated at temperatures between 60°C and 65°C, but more slowly than bacteria. However, as shown for poliovirus and hepatitis A, as temperatures increase above 70°C, a greater than 5 log inactivation (99.999% reduction) is achieved in less than 1 minute. Based on these results, it is considered that the process of heating water to a rolling boil, as recommended in the *WHO Guidelines for Drinking-water Quality* (WHO 2011), is sufficient to inactivate pathogenic bacteria, viruses and protozoa. After the water has reached a rolling boil, it should be removed from the heat, allowed to cool naturally, without the addition of ice, and protected from post-treatment recontamination during storage. If turbid water needs to be clarified for aesthetic reasons, this should be done before boiling.

If a treatment process meets the turbidity requirements specified in the *Guidelines for Canadian Drinking Water Quality* the following may apply (Health Canada 2011):

| Treatment process             | Virus removal log credit |
|-------------------------------|--------------------------|
| Conventional filtration       | 2.0                      |
| Direct filtration             | 1.0                      |
| Slow sand filtration          | 2.0                      |
| Diatomaceous earth filtration | 1.0                      |
| Microfiltration               | No credit                |

Ultrafiltration membranes typically remove viruses to greater than a 3-log level. Nanofiltration and reverse osmosis membranes are typically considered to be non-porous and represent a physical barrier to viruses. Because any breach in the integrity of the membranes would allow viruses to pass through the filter, direct integrity testing should be conducted. Health Canada (2013) gives no virus log credits for microfiltration, but for UF, NF and RO log credits are based on demonstration and challenge testing, verified by direct integrity testing.

The ESR is conducting a long-term research project for the Ministry of Health with the aim to generate evidence about the concentrations and risks to public health of viruses in river water. The 2009–2010 report presented data gathered from water samples taken from the Waikato River in Waikato and the Oreti River in Southland to put together a quantitative microbial risk assessment. This provided a statistical estimate of the risk of infections arising from various viruses following consumption of drinking-water, and enabled an estimate of the amount of treatment required to reduce the risk of viral-related waterborne disease. Key findings were:

- Enteric viruses were detected in essentially all river water samples taken from the Waikato River at Huntly and the Oreti River at Branxholme, with most water samples containing three or more virus types. Adenovirus (AdV), norovirus-GII (NoV GII) and rotavirus (RoV) were the most frequently detected.
- The risk of infection is assumed to be independent for each virus.

- The project predicts that daily consumption of untreated river water will cause most of the population of Huntly or Invercargill to become infected by each of the enteric viruses over the course of one year. This prediction gives a baseline from which to assess the amount of virus treatment required. Water treatment significantly reduced the number of people predicted to become infected.
- For Waikato River water, if 4-log-removal/inactivation of viruses were achieved at the treatment plant, and it is assumed that all the viruses in the source water were infective, it was predicted that 200–300 people in Huntly would become infected with RoV and with AdV during one year. However, if only 10 percent of the viruses in the intake water were infective then the number of infected people would drop to about 30 in one year.
- Similarly, for the Oreti River water, if 4-log-removal/inactivation were achieved at the treatment plant, and it is assumed that all the viruses in the source water were infective, it was predicted that 1000–3500 people in Invercargill would become infected with RoV and with AdV during one year. If only 10 percent of the viruses in the intake water were infective, the number of infected people would fall to 150–350 in one year.
- An assessment for NoV is not yet possible; however if the values are of a similar magnitude to those of AdV and RoV, then some of the outbreaks of NoV seen in the community could arise from drinking-water treated to achieve at least a 4-log removal of viruses.
- The study has indicated that even at low concentrations, waterborne viruses may have an effect on public health, and that in the absence of water treatment achieving 4-log removal or inactivation of viruses, the effect on health would be significant.

No analyses were carried out to determine whether either the Huntly or Branxholme treatment plants operate sufficiently to reduce the viral concentration, or whether the level of disease predicted by the study could be seen in the community by medical professionals; it could be present as 'background' gastroenteritis.

Linden and Sobsey (2005) studied the efficacy of UV disinfection on some waterborne pathogenic viruses and bacteriophages. A conclusion was that the inactivation of human enteric viruses and bacteriophages by UV irradiation is proven not predictable by the type and size of the virus or its nucleic acid genome. Overall, bacteriophage MS2 was a good conservative surrogate for representing the UV inactivation of many viruses, with the exception of adenovirus. These data will be helpful for utilities and regulatory officials to evaluate the efficacy of UV irradiation for viruses and plan for levels of disinfection that will help ensure public health in drinking water.

Hijnen et al (2006) reviewed information about inactivation credits of UV radiation for viruses, bacteria and protozoan (oo)cysts in water. In the group of pathogenic micro-organisms, viruses are generally more resistant than *Cryptosporidium*, *Giardia* and the bacterial pathogens. Adenovirus 40 is the most UV resistant waterborne pathogen known. *Acanthamoeba* is also very resistant. Bacterial spores, especially environmental spores of *Clostridium* are also resistant to UV, with k-values that are comparable to the Adenoviruses. They summarised the doses required to achieve a range of log credits for a wide range of micro-organisms. The yellow highlighting in the following table indicates the microorganisms that will not achieve 4-log inactivation by UV appliances

that deliver the standard 40 mJ/cm<sup>2</sup>. That includes several types of adenovirus, and Calicivirus canine. Rotavirus SA-11 and Calicivirus feline are marginal.

| Log inactivation                            | Required fluence |     |     |     |
|---|------------------|-----|-----|-----|
|   | 1                | 2   | 3   | 4   |
| <i>Bacillus subtilis</i> <sup>a</sup>       | 56               | 111 | 167 | 222 |
| Adenovirus type 40                          | 56               | 111 | 167 | b   |
| <i>Clostridium perfringens</i> <sup>d</sup> | 45               | 95  | 145 | b   |
| Adenovirus type 2,15,40,41                  | 42               | 83  | 125 | 167 |
| <i>Acanthamoeba</i> <sup>c</sup>            | 40               | 71  | 119 | 167 |
| Adenovirus a (no type 40)                   | 25               | 50  | d   | b   |
| Calicivirus canine                          | 10               | 21  | 31  | 41  |
| Rotavirus SA-11                             | 10               | 20  | 29  | 38  |
| Calicivirus feline                          | 9                | 19  | 28  | 38  |
| Coxsackie virus B5                          | 8                | 17  | 25  | 34  |
| <i>Streptococcus faecalis</i> <sup>a</sup>  | 9                | 16  | 23  | 30  |
| <i>Legionella pneumophila</i> <sup>d</sup>  | 8                | 15  | 23  | 30  |
| Poliovirus type 1                           | 7                | 15  | 22  | 30  |
| <i>Shigella sonnei</i> <sup>d</sup>         | 6                | 13  | 19  | 26  |
| <i>Salmonella typhi</i> <sup>a</sup>        | 6                | 12  | 17  | 51  |
| Hepatitis A                                 | 6                | 11  | 17  | 22  |
| Calicivirus bovine                          | 5                | 11  | 16  | 21  |
| <i>E. coli</i> O157 <sup>d</sup>            | 5                | 9   | 14  | 19  |
| <i>E. coli</i> <sup>a</sup>                 | 5                | 9   | 14  | 18  |
| <i>Cryptosporidium</i> USEPA <sup>c</sup>   | 3                | 6   | 12  | e   |
| <i>Giardia</i> USEPA <sup>c</sup>           | 2                | 5   | 11  | e   |
| <i>Campylobacter jejuni</i> <sup>d</sup>    | 3                | 7   | 10  | 13  |
| <i>Yersinia enterocolitica</i> <sup>d</sup> | 3                | 7   | 10  | 13  |
| <i>Legionella pneumophila</i> <sup>d</sup>  | 3                | 6   | 8   | 11  |
| <i>Shigella dysenteriae</i> <sup>d</sup>    | 3                | 5   | 8   | 11  |
| <i>Vibrio cholera</i> <sup>d</sup>          | 2                | 4   | 7   | 9   |

a = environmental spp.; b = Log inactivation max <4 log; c = no correction for environmental spp. (research needed); d = corrected for environmental spp.; e = no value due to tailing.

UV disinfection can be achieved using low pressure (LP) lamps, which emit UV light at essentially a single (monochromatic) wavelength (~254 nm), or medium pressure (MP) lamps, which emit radiation across a broader (polychromatic) spectrum. Ultraviolet light-emitting diodes (UV-LEDs) are an emerging technology for UV water treatment. A review of published studies on the application of UV-LEDs concluded that a standard method for the UV-dose determination of UV-LEDs is needed to reduce the inconsistent and incomparable dose-response data currently available in the literature. From Health Canada (2017).

## 7.5 Sampling, testing and data interpretation

The determination of virus removal efficiency within a water treatment plant, or occurrence in treated water, is dependent on the ability to reliably detect and enumerate the viruses. Determination of the health risk that viruses pose to the community using the water further depends on the ability to demonstrate or infer that the viruses detected are capable of causing human infection.

**Virus detection and enumeration:** No single method allows detection of all virus types and strains. Traditionally, viruses have been concentrated from water samples using filtration or adsorption based techniques with subsequent detection by culture in a permissive human or primate cell line. Many of the virus concentration techniques were developed using poliovirus or other enterovirus types and it is unclear how effectively these work for other virus types, particularly norovirus. Most virus concentration and detection methods recover less than 50 percent of the viruses present in a sample (Haramoto et al 2005).

Virus concentration from large volumes of water is laborious and time consuming and adds significantly to the cost of virus analysis. Not all virus types are culturable in cell lines, with norovirus and hepatitis E virus not able to be cultured routinely and are not detectable using traditional culture-based methods. Some virus cell culture-lines are susceptible to several virus types, for example BGM cells will permit enterovirus, adenovirus and reovirus to grow (Lee and Jeong 2004), thus if all these are present in one sample, they cannot be separated based on cytopathic effect alone.

Viruses (culturable and non-culturable) can be detected at very low levels using polymerase chain reaction (PCR) based molecular methods that target novel DNA or RNA sequences in the genetic information of the virus. Virus assay using PCR can target individual viruses or groups of viruses, and multiple analyses are required to investigate all the relevant viruses in a particular sample (Greening et al 2002). Recent advances in real-time PCR have made these methods both rapid and quantitative and potentially quite routine. PCR based methods use only a small amount of the original sample in the assay, so compared with culture methods that typically use considerably more of the original sample, PCR molecular methods are around 10-fold less sensitive than culture based methods for virus detection (Lewis et al 2000). PCR-based methods are very utilitarian, offering the advantages of rapid turn-around time, detection of currently unculturable viruses, and lower assay costs than traditional culturing methods (Lee and Jeong 2004). However, they are still generally too expensive to be used routinely.

DWI (2013) discusses analytical techniques for adenovirus and norovirus.

**Virus sampling strategies:** Relatively few viruses are needed for an infection to occur in a susceptible person, so low numbers of viruses must be quantified in relatively large volumes of finished water. For example, if source waters contain 5000 viruses per 100 L it would be necessary to sample and analyse at the very least 200 L of finished water to demonstrate a 4-log reduction in viruses. Typically, source water sample volumes should be 10–100 L, partially treated waters 50–200 L, and finished, disinfected water sample volumes 100–200 L.

The current cost of virus analysis may make regular monitoring beyond the means of many groups responsible for drinking-water treatment.

Specific short-term studies of virus occurrence and inactivation/removal within a plant are feasible but should be designed carefully to allow adequate interpretation of the data.

**Determination of virus infectivity:** Molecular methods for virus detection do not specifically show whether viruses are still infectious. Detection of viruses using a cell-culture based technique shows that the viruses are infectious and pose a risk of illness to water consumers. Infectivity of a virus can however be inferred for certain RNA viruses (norovirus, enteroviruses, Hepatitis A and E) from molecular detection data where the viruses are subjected to chemical disinfection, but not UV disinfection (Greening et al 2002). Virus viability is inferred whenever virus nucleic acid is detected because the nucleic acids (single stranded RNA) are extremely susceptible to degradation in the environment.

**Interpretation of virus detection and occurrence data:** Where viruses are detected in finished drinking-water the response to the data should be based, in consultation with relevant health authorities, on a risk evaluation incorporating the type and number of virus detected, the reproducibility of the result, and the health status and vulnerability of the community.

## 7.6 C.t values

A C.t value is the product of the residual concentration (C mg/L) of the disinfectant after the contact time (t minutes) required to cause a specified level of inactivation in a micro-organism. The C.t value is a measure of the exposure to the disinfectant and has the unit mg.min/L. Further discussion appears in Chapter 15: Disinfection Processes, section 15.2.1 (C.t values) and section 15.2.9 (measuring the contact time).

A range of C.t values is given in Appendix C of the Disinfection Profiling and Benchmarking Technical Guidance Manual (USEPA 1999), including C.t tables for disinfection of viruses by various disinfectants. These tables are referenced to AWWA (1991) in the text of USEPA (1999) and in CRC (2005). The 1991 data were carried out using hepatitis A virus and are derived from experiments conducted by Sobsey and co-workers in the late 1980s (Sobsey et al 1988). Subsequent publications continue to use the USEPA 1991 tables because research on disinfectant contact time has apparently not been revisited.

The USEPA Surface Water Treatment Rule (SWTR) required (inter alia) that treatment of both filtered and unfiltered sources remove or inactivate 4 log (99.99 percent) of viruses. This requirement was enacted in 1989. The 1991 tables were developed to assist water suppliers assess the degree of disinfection of viruses being achieved at their water treatment plants.

USEPA's LT2ESWTR (2003/2006a) includes a table showing the C.t values for disinfecting viruses using UV light. The proposed UV doses for inactivation of viruses were based on the dose-response of adenovirus because, among viruses that have been studied, it appears to be the most UV-resistant and is a widespread waterborne pathogen. Health effects of adenovirus are described in Embrey (1999).

It is doubtful that this same approach was used in developing the 1991 tables; viruses are simply referred to collectively, and 'viruses' were not defined in the 1991 information provided. Some viruses require a much higher C.t value than others. Nor is it explained whether the data relate to studies in single virions or cell-associated virions – the latter require a higher C.t value.

Table 7.1 shows the UV doses that water suppliers must apply to receive credit for up to 4 log inactivation of viruses. This is taken from Table IV – 21 in USEPA (2003), Table IV.D-5 in USEPA (2006a), and Table 1.4 in USEPA (2006b). The UV dose requirements in Table 7.1 account for uncertainty in the UV dose-response relationships of the target pathogens but do not address other significant sources of uncertainty in full-scale UV disinfection applications. These other sources of uncertainty are due to the hydraulic effects of the UV installation, the UV reactor equipment (eg, UV sensors), and the monitoring approach. Due to these factors, the USEPA requires water suppliers to use UV reactors that have undergone validation testing, see Chapter 8. Clearly, UV disinfection is impractical for attempting to achieve 4-log inactivation of adenovirus; treatment plants using UV disinfection for protozoa inactivation would achieve both bacterial compliance and 4-log virus inactivation simply by chlorination. The data in Table 7.1 are based on adenovirus studies; dose requirements for hepatitis A, coxsackievirus B5, poliovirus type 1 and rotavirus SA-11 indicate that a dose of around 40 mJ/cm<sup>2</sup> is generally adequate for 4-log inactivation (Health Canada 2011).

**Table 7.1: UV dose requirements for virus inactivation credit**

| Log credit           | Virus <sup>1</sup><br>UV dose (mJ/cm <sup>2</sup> ) |
|----------------------|---|
| 0.5                  | 39  |
| 1.0 (90% removal)    | 58  |
| 1.5                  | 79  |
| 2.0 (99% removal)    | 100   |
| 2.5                  | 121   |
| 3.0 (99.9% removal)  | 143   |
| 3.5                  | 163   |
| 4.0 (99.99% removal) | 186   |

<sup>1</sup> Based on adenovirus studies.



Tables 7.2, 7.3, 7.4, 7.5 have been taken from Appendix C of USEPA (1999) and copied from the 1991 publication, where they refer to 'undefined viruses'. Health Canada (2011) states that the data for ozone are based on poliovirus 1, and the rest is based on hepatitis A virus; and the C.t values incorporate a safety factor. The units are mg.min/L. Although ozone is clearly the most effective disinfectant, it does not leave a residual. Chlorine is more potent than chlorine dioxide, and chloramine is all but ineffective.

A free available chlorine content of 0.20 mg/L after 30 minutes retention time is equivalent to a C.t value of 6. Based on Table 7.2, this would achieve 4 log inactivation of viruses at 10°C. To achieve 4 log inactivation at 5°C, which requires a C.t value of 8.0, the minimum retention time should be 40 minutes (0.20 mg/L after 40 minutes retention time; C.t = 8.0). If that retention time cannot be achieved, the residual free chlorine content should be increased to 0.30 mg/L (0.30 mg/L after 30 minutes retention time; C.t = 9.0).

**Table 7.2: C.t values for inactivation of viruses by free chlorine, pH 6–9**

| Log inactivation | 1°C  | 5°C | 10°C | 15°C | 20°C | 25°C |
|------------------|------|-----|------|------|------|------|
| 2                | 5.8  | 4.0 | 3.0  | 2.0  | 1.0  | 1.0  |
| 3                | 8.7  | 6.0 | 4.0  | 3.0  | 2.0  | 1.0  |
| 4                | 11.6 | 8.0 | 6.0  | 4.0  | 3.0  | 2.0  |

**Table 7.3: C.t values for inactivation of viruses by chloramine**

| Log inactivation | 1°C  | 5°C  | 10°C | 15°C | 20°C | 25°C |
|------------------|------|------|------|------|------|------|
| 2                | 1243 | 857  | 643  | 428  | 321  | 214  |
| 3                | 2063 | 1423 | 1067 | 712  | 534  | 356  |
| 4                | 2883 | 1988 | 1491 | 994  | 746  | 497  |

**Table 7.4: C.t values for inactivation of viruses by chlorine dioxide, pH 6–9**

| Log inactivation | 1°C  | 5°C  | 10°C | 15°C | 20°C | 25°C |
|------------------|------|------|------|------|------|------|
| 2                | 8.4  | 5.6  | 4.2  | 2.8  | 2.1  | 1.4  |
| 3                | 25.6 | 17.1 | 12.8 | 8.6  | 6.4  | 4.3  |
| 4                | 50.1 | 33.4 | 25.1 | 16.7 | 12.5 | 8.4  |

**Table 7.5: C.t values for inactivation of viruses by ozone**

| Log inactivation | 1°C | 5°C | 10°C | 15°C | 20°C | 25°C |
|------------------|-----|-----|------|------|------|------|
| 2                | 0.9 | 0.6 | 0.5  | 0.3  | 0.25 | 0.15 |
| 3                | 1.4 | 0.9 | 0.8  | 0.5  | 0.40 | 0.25 |
| 4                | 1.8 | 1.2 | 1.0  | 0.6  | 0.50 | 0.30 |

Several studies show that iodine solutions are effective virucides. Viruses are more resistant than bacteria to iodine disinfection, typically requiring higher C.t.s than bacteria and in some cases much higher C.t.s at low pH levels (eg, 4–5), where hypiodous acid (HOI) is not present, and at cold water temperatures (eg, 5°C). Most studies evaluated the virucidal efficacy of iodine solutions against f2 virus and poliovirus. Data indicate 2-log inactivation at near neutral to alkaline pH levels (6–10) and various water temperatures (5–30°C) occurred at C.t.s of 15–75 mg-min/L with the higher C.t.s occurring at lower pH levels and colder water temperatures. Iodine resin studies show at least 4-log inactivation of various viruses at pH levels above 3.0 with low turbidity water for both triiodide and pentaoidide resins. From USAPHC.

DWSNZ section 4.3.2.1 (bacterial compliance) allows *E. coli* monitoring to be substituted by online FAC monitoring provided the chlorine contact time is more than 30 minutes, and the pH is <8, turbidity <1 NTU. This represents a C.t value of 6 or more. The DWSNZ also assume that drinking-water that meets the bacterial compliance requirements should be free from infective viruses. That means that when the water temperature falls below 10°C, either the FAC level or the contact time, or both, need to be increased. During an outbreak of norovirus at Cardrona in 2012, samples were found to contain viruses in the absence of *E. coli* when the chlorine dose was inadequate.

Some new research has been reported in DWI (2010). Baseline disinfection experiments were performed in pH 7 and pH 8 demand-free reagent grade water with 0.2 mg/L free chlorine or 1 mg/L monochloramine at 5°C. These baseline experiments were performed using several human adenoviruses (HAdV2, HAdV40, and HAdV41), two coxsackieviruses (coxsackievirus B3 [CVB3] and coxsackievirus B5 [CVB5]), two echoviruses (echovirus 1 [E1] and echovirus 11 [E11]) and murine norovirus (MNV, studied as a surrogate for human norovirus). The most resistant representative of each virus type for each disinfectant was selected for additional virus disinfection experiments using three distinct types of source water collected from drinking water treatment plants. Experiments were performed in source water at pH 7 and 8 using 0.2 and 1 mg/L free chlorine or 1 mg/L and 3 mg/L monochloramine at 5 and 15°C. Free chlorine and monochloramine disinfection experiments were then performed for aggregated preparations of HAdV2 in source water from one drinking water treatment plant. Viral titres before and after disinfection were determined by virus-specific plaque assays. The efficiency factor Hom model was used to calculate C.t values (disinfectant concentration in mg/L x exposure in min) required to achieve 2-, 3-, and 4-log<sub>10</sub> reductions in viral titres.

In all water types, chlorine and monochloramine disinfection were most effective for MNV, with 3-log<sub>10</sub> C.t values at 5°C ranging from <0.02 to 0.03 for chlorine and 53 to 111 for monochloramine. Chlorine disinfection was least effective for CVB5 for all water types, with 3-log<sub>10</sub> C.t values at 5°C ranging from 2.3 to 7.6. Monochloramine disinfection was least effective for HAdV2 and E11, depending on pH and water type. At 5°C, 3-log<sub>10</sub> C.t values for HAdV2 ranged from 1044 to 3308, while those for E11 ranged from 814 to 2288. Overall, chlorine was much more effective than monochloramine, and disinfection proceeded faster at 15°C and at pH 7 for all water types. C.t values for chlorine and monochloramine disinfection of aggregated HAdV2 were 2 and 1.4 times higher than for monodispersed HAdV2, respectively.

The results from this project indicate that a C.t value of 10 (or 20, if incorporating a 2x factor of safety for aggregated virus) may be needed to achieve a 4-log<sub>10</sub> inactivation of CVB5 with free chlorine at 5°C, pH 8, which is above the C.t value of 8 recommended in the USEPA's Guidance Manual for Compliance with the Filtration and Disinfection Requirements for Public Water Systems Using Surface Water Sources (Guidance Manual) to achieve a 4-log<sub>10</sub> inactivation with chlorine at 5°C, pH 6–9. The Guidance Manual recommended C.t value of 8 included a safety factor of 3x to account for potential virus aggregation. However, C.t values for the study viruses, including CVB5, were below the 2-log<sub>10</sub> C.t value of 12 reported by the World Health Organization as an expected performance level for chlorine disinfection of viruses in water at 5°C, pH 7–7.5.

Some more recent data was presented by Keegan et al (2012). Although it was a recycled wastewater study, the findings are still relevant to drinking water; the less than expected protective effect of turbidity was interesting:

**Table 1E: Free available chlorine C.t values (mg/L.min) for 4-log inactivation of Coxsackie B5 (CB5) virus calculated by determining the integral of residual chlorine vs time for wastewater of various turbidities and pHs at 10°C**

| pH | C.t value, 0.2 NTU using 6.5 mg/L chlorine | C.t value, 2 NTU using 6.87 mg/L chlorine | C.t value, 5 NTU using 6.87 mg/L chlorine | C.t value, 20 NTU using 9 mg/L chlorine |
|----|--|---|---|---|
| 7  | 5.4  | 5.5                                       | 6.0                                       | 25.8                                    |
| 8  | 15.5                                       | 15.7                                      | 21.9                                      | 34.5                                    |
| 9  | 24   | 26  | 28  | 52                                      |

**Table 2E: Preformed monochloramine C.t values (mg/L.min) for 4-log inactivation of adenovirus 2 calculated by determining the residual monochloramine vs time for wastewater of various turbidities and pHs at 10°C**

| pH | C.t value, 2 NTU using 15 mg/L monochloramine | C.t value, 5 NTU using 15 mg/L monochloramine | C.t value, 20 NTU using 16 mg/L monochloramine |
|----|---|---|--|
| 7  | 3,082   | 3,337   | 3,757  |
| 8  | 3,949   | 4,426   | 5,900  |
| 9  | 6,746   | 9,096   | 10,718   |

## References

Amar CFL, East CL, Grant KA, et al. 2005. Detection of viral, bacterial, and parasitological RNA or DNA of nine intestinal pathogens in fecal samples archived as part of the English Infectious Intestinal Disease study – assessment of the stability of target nucleic acid. *Diagnostic Molecular Pathology* 14: 90–6.

Ashbolt NJ. 2004. Microbial contamination of drinking water and disease outcomes in developing regions. *Toxicology* 198: 229–38.

AWWA. 1991. *Guidance Manual for Compliance with the Filtration and Disinfection Requirements for Public Water Systems Using Surface Water Sources*. Denver, CO: American Water Works Association.

Brooks GF, Carroll KC, Butel JS, et al. 2007. *Jawetz, Melnick & Adelberg's Medical Microbiology*. New York: McGraw Hill.

CRC for Water Quality and Treatment. *Strategic Review of Waterborne Viruses*, Occasional Paper 11. CRC for Water Quality and Treatment, Private Mail Bag 3, Salisbury, South Australia 5108. See [www.wqra.com.au/publications/](http://www.wqra.com.au/publications/) or <http://water.nstl.gov.cn/MirrorResources/283/index.html>.

DRG (Disinfection Review Group). 2002. *Pilot Study Investigations: Surrogate study results and recommendations*. A Disinfection Review Group report to Watercare Services Ltd.

DWI. 2010. *Contaminant Candidate List Viruses: Evaluation of disinfection efficacy* (Project #3134). Executive Summary: <http://dwi.defra.gov.uk/research/completed-research/2000today.htm>.

DWI. 2013. Viruses in raw and partially treated water: targeted monitoring using the latest methods. Project WT 1227. 66 pp. <http://dwi.defra.gov.uk/research/completed-research/reports/DWI70-2-234.pdf> or <http://dwi.defra.gov.uk/>.

Embrey M. 1999. *Adenovirus in Drinking Water, Literature Summary. Final report*. Washington DC: The George Washington University School of Public Health and Health Services, Department of Environmental and Occupational Health.

ESR. 2004. *Annual Summary of Outbreaks in New Zealand: 2003*. Report to Ministry of Health ISSN 1176-3485.

ESR. 2010. *Environmental Microbiological Risk Assessment and Management; EMRAM Virus Project 2009–2010 Progress Report*. Client Report (FW10051).

ESR. 2010a. *Guidelines for Separation Distances Based on Virus Transport Between On-site Domestic Wastewater Systems and Wells*. ESR Client Report No. CSC1001. 296 pp. [http://www.envirolink.govt.nz/PageFiles/31/Guidelines\\_for\\_separation\\_distances\\_based\\_on\\_virus\\_transport\\_.pdf](http://www.envirolink.govt.nz/PageFiles/31/Guidelines_for_separation_distances_based_on_virus_transport_.pdf).

Gerba CP, Rose J. 1992. Estimating viral risk from drinking-water. In: *Comparative Environmental Risk Assessment*, chapter 9, pp 117–37. CR Conthern Lewis Publishers.

Gratacap-Cavallier B, Genoulaz O, Brengel-Pesce K, et al. 2000. Detection of human and animal rotavirus sequences in drinking water. *Applied and Environmental Microbiology* 66: 2690–2.

Greening G, Hewitt J, Lewis G. 2002. Evaluation of integrated cell culture-PCR (C-PCR) for virological analysis of environmental samples. *Journal of Applied Microbiology* 93: 745–50.

Haramoto E, Katayama H, Oguma K, et al. 2005. Application of cation-coated filter method for detection of noroviruses, enteroviruses, adenoviruses, and torque tenoviruses in the Tamagawa River in Japan. *Applied and Environmental Microbiology* 71: 2403–11.

Health Canada. 2011. *Guidelines for Canadian Drinking Water Quality: Guideline technical document – enteric viruses*. Water, Air and Climate Change Bureau, Healthy Environments and Consumer Safety Branch, Health Canada, Ottawa, Ontario. 70 pp. (Catalogue No H129-6/2011E). <http://www.hc-sc.gc.ca/ewh-semt/pubs/water-eau/enteric-enterovirus/index-eng.php>.

Health Canada. 2013. Guidance on the Use of the Microbiological Drinking Water Quality Guidelines. <http://www.hc-sc.gc.ca/ewh-semt/pubs/water-eau/micro/index-eng.php>.

Health Canada. 2017. *Enteric Viruses in Drinking Water: A document for public discussion*. Guidelines for Canadian Drinking Water Quality: Guideline Technical Document. 112 pp. <https://www.canada.ca/content/dam/hc-sc/documents/programs/consultation-enteric-virus-drinking-water/document/enteric-viruses-drinking-water.pdf>.

Hewitt J, Bell D, Simmons GC, et al. 2007. Gastroenteritis outbreak caused by waterborne norovirus at a New Zealand ski resort. *Appl Environ Microbiol* 73(24): 7853–7.

Hijnen WAM, Beerendonk EF, Medema GJ. 2006. Inactivation credit of UV radiation for viruses, bacteria and protozoan (oo)cysts in water: a review. Reprinted from *Water Research* 40: 3–22, Copyright 2006, with permission from the copyright holder, Elsevier Ltd. 38 pages.

[https://www.researchgate.net/profile/Wim\\_Hijnen/publication/43945991\\_Inactivation\\_credit\\_of\\_UV-radiation\\_for\\_viruses\\_bacteria\\_and\\_protozoan\\_oocysts\\_a\\_review\\_THESIS\\_VERSION/links/02bfe5100d79c795d5000000.pdf](https://www.researchgate.net/profile/Wim_Hijnen/publication/43945991_Inactivation_credit_of_UV-radiation_for_viruses_bacteria_and_protozoan_oocysts_a_review_THESIS_VERSION/links/02bfe5100d79c795d5000000.pdf).

Hrudey SE, Hrudey EJ. 2007. Published case studies of waterborne disease outbreaks – evidence of a recurrent threat. *Water Environment Research* 79: 233–45.

Hunter P. 1997. Viral gastroenteritis in waterborne disease. *Epidemiology and Ecology*, chapter 28, pp 222–31. John Wiley & Sons.

Kasorndorkbua C, Opriessnig T, Huang FF, et al. 2005. Infectious swine hepatitis E virus is present in pig manure storage facilities on United States farms, but evidence of water contamination is lacking. *Applied and Environmental Microbiology* 71: 7831–7.

Kaappinen A, Pitkänen T, Miettinen IT. 2017. Persistent norovirus contamination of groundwater supplies in two waterborne outbreaks. *Food and Environmental Virology* 10(1): 39–50.

Keegan A, et al. 2012. *Chlor(am)ine Disinfection of Human Pathogenic Viruses in Recycled Waters*. SWF62M-2114, for Smart Water Fund. 195 pp. [https://www.waterportal.com.au/swf/images/swf-files/62m-2114-chlorine-disinfection-of-human-pathogenic-viruses-\\_final\\_report.pdf](https://www.waterportal.com.au/swf/images/swf-files/62m-2114-chlorine-disinfection-of-human-pathogenic-viruses-_final_report.pdf).

Kim J. 2005. *Human Adenovirus in the Waikato River: Implication for water supply and public health*. MSc thesis. University of Auckland Library.

- Klemola P, Kaijalainen S, Ylipaasto P, et al. 2008. Diabetogenic effects of the most prevalent enteroviruses in Finnish sewage. *Immunology of Diabetes* 1150: 210–12.
- Kuniholm MH, Purcell R, McQuillan G, et al. 2009. Epidemiology of hepatitis E virus in the United States: Results from the Third National Health and Nutrition Examination Survey, 1988–1994. *The Journal of Infectious Diseases* 200: 48–56.
- LeChevallier M, Au K-K. 2004. *Water Treatment and Pathogen Control: Process efficiency in achieving safe drinking-water*. WHO Drinking-Water Quality Series. WHO, Geneva. [http://www.who.int/water\\_sanitation\\_health/publications/en/](http://www.who.int/water_sanitation_health/publications/en/).
- Lee HK, Jeong YS. 2004. Comparison of total culturable virus assay and multiplex integrated cell culture-PCR for reliability of waterborne virus detection. *Applied & Environmental Microbiology* 70: 3632–6.
- Lewis GD, Austin FJ, Loutit MW, et al. 1986. Enterovirus removal from sewage – the effectiveness of four different treatment plants. *Water Research* 20: 1291–7.
- Lewis G, Molloy SL, Greening GE, et al. 2000. Influence of environmental factors on virus detection by RT-PCR and cell culture. *Journal of Applied Microbiology* 88: 633–40.
- Linden KG, Sobsey MD. 2005. *Final Report: Effectiveness of UV Irradiation for Pathogen Inactivation in Surface Waters*. EPA Grant Number: R829012. [https://cfpub.epa.gov/ncer\\_abstracts/index.cfm/fuseaction/display.highlight/abstract/1128/report/F](https://cfpub.epa.gov/ncer_abstracts/index.cfm/fuseaction/display.highlight/abstract/1128/report/F).
- Meng XJ. 2005. Hepatitis E virus: Cross-species infection and zoonotic risk. *Clinical Microbiology Newsletter* 27: 43–8.
- Ministry of Health. 2005. *Drinking-water Standards for New Zealand 2005*. Wellington: Ministry of Health. Also see the 2008 revision.
- NHMRC, NRMCC. 2011. *Australian Drinking Water Guidelines Paper 6 National Water Quality Management Strategy*. Canberra: National Health and Medical Research Council, National Resource Management Ministerial Council, Commonwealth of Australia. 1244 pp. <http://www.nhmrc.gov.au/guidelines/publications/eh52>.
- Nwachuku N, Gerba CP. 2004. Emerging waterborne pathogens: can we kill them all? *Current Opinion in Biotechnology* 15: 175–80.
- Parashar UD, Hummelman EG, Bresee JS, et al. 2003. Global illness and deaths caused by rotavirus disease in children. *Emerging Infectious Diseases* 9: 565–72.
- Pérez-Vargas J, Isa P, López S, et al. 2006. Rotavirus vaccine: early introduction in Latin America-risks and benefits. *Archives of Medical Research* 37: 1–10.
- PMEP (accessed 2011). *Pesticide Active Ingredient Information: Biopesticides and biocontrols: Bioinsecticides*. <http://pmep.cce.cornell.edu/profiles/index.html>.
- Shin G-A, Sobsey MD. 2003. Reduction of Norwalk Virus, Poliovirus 1, and Bacteriophage MS2 by ozone disinfection of water. *Appl Environ Microbiol* 69(7): 3975–8.
- Sobsey MD, Fuji T, Shields PA. 1988. Inactivation of hepatitis A virus and model viruses in water by free chlorine and monochloramine. *Water Science and Technology* 20: 385–91.

- Sobsey MD. 1989. Inactivation of health-related microorganisms in water by disinfection processes. *Water Science and Technology* 21(3): 179–95.
- Teunis PFM, Moe CL, Liu P, et al. 2008. Norwalk virus: How infectious is it? *Journal of Medical Virology* 80(8): 1468–76.
- Till D, McBride G, Ball A, et al. 2008. Large-scale freshwater microbiological study: rationale, results and risks. *Journal of Water and Health* 6(4): 443–60.
- Tree JA, Adams MR, Lees DN. 2003. Chlorination of indicator bacteria and viruses in primary sewage effluent. *Applied & Environmental Microbiology* 69(4): 2038–43.
- USAPHC. March 2006, updated January 2011. *Iodine Disinfection in the Use of Individual Water Purification Devices*. Technical Information Paper #-31-005-0211, prepared by: Steven H Clarke, Environmental Engineer. US Army Public Health Command. 15 pp. <http://phc.amedd.army.mil/PHC%20Resource%20Library/Iodine%20Disinfection%20in%20the%20Use%20of%20Individual%20Water%20Purification%20Devices.pdf>.
- USEPA. 1994. *National Primary Drinking Water Regulations: Enhanced surface water treatment regulations*. 59 FR 38832, 29 July.
- USEPA. 1999. *Disinfection Profiling and Benchmarking Guidance Manual*. EPA 815-R-99. Available at: <http://www.epa.gov/safewater/mdbp/mdbptg.html> or go to <http://water.epa.gov/lawsregs/rulesregs/sdwa/mdbp/index.cfm>.
- USEPA. 2003. *National Primary Drinking Water Regulations: Long Term 2 Enhanced Surface Water Treatment Rule; Proposed Rule*. 40 CFR Parts 141 and 142, 11 August. Now see USEPA (2006a) for Final Rule.
- USEPA. 2006a. *National Primary Drinking Water Regulations: Long Term 2 Enhanced Surface Water Treatment Rule: Final Rule*. (LT2ESWTR). Federal Register Part II, 40 CFR Parts 9, 141 and 142. Washington: National Archives and Records Administration. See <http://www.epa.gov/fedrgstr/EPA-WATER/2006/January/Day-05/w04a.pdf> <http://www.epa.gov/fedrgstr/EPA-WATER/2006/January/Day-05/w04b.pdf> <http://www.epa.gov/fedrgstr/EPA-WATER/2006/January/Day-05/w04c.pdf> or go to <http://water.epa.gov/lawsregs/rulesregs/sdwa/mdbp/index.cfm> or go to <http://www.epa.gov/lawsregs/rulesregs/sdwa/lt2/compliance.cfm>.
- USEPA. 2006b. *Ultraviolet Disinfection Guidance Manual for the Final Long Term 2 Enhanced Surface Water Treatment Rule*. Office of Water, EPA 815-R-06-007, November. See: [www.epa.gov/ogwdw/disinfection/lt2/pdfs/guide\\_lt2\\_uvguidance.pdf](http://www.epa.gov/ogwdw/disinfection/lt2/pdfs/guide_lt2_uvguidance.pdf).
- Vasickova P, Dvorska L, Lorencova A, et al. 2005. Viruses as a cause of foodborne diseases: a review of the literature. *Veterinarni Medicina* 50: 89–104.
- Vivier JC, Ehlers MM, Grabow WO. 2004. Detection of enteroviruses in treated drinking-water. *Water Research* 38(11): 2699–705.
- Watercare Services Ltd (personal communication). 2002. *Surrogate Study: Mangere wastewater treatment plant*.
- Watercare Services Ltd (personal communication). 2003, 2004. *Adenovirus and Enterovirus Monitoring Data, Waikato River at Mercer*.

WHO. 2004. *Guidelines for Drinking-water Quality 2004* (3rd edition). Geneva: World Health Organization. Available at:

[www.who.int/water\\_sanitation\\_health/dwq/gdwq3/en/print.html](http://www.who.int/water_sanitation_health/dwq/gdwq3/en/print.html) see also the addenda.

WHO. 2004a. *Water Treatment and Pathogen Control: Process efficiency in achieving safe drinking water*. 136 pp.

[www.who.int/water\\_sanitation\\_health/publications/en/index.html](http://www.who.int/water_sanitation_health/publications/en/index.html).

WHO. 2006 (updated Oct 2007). Review of latest available evidence on potential transmission of avian influenza (H5N1) through water and sewage and ways to reduce the risks to human health. 37 pp.

[http://www.who.int/water\\_sanitation\\_health/publications/potential-transmission-of-avianinfluenza/en/](http://www.who.int/water_sanitation_health/publications/potential-transmission-of-avianinfluenza/en/).

WHO. 2011. *Guidelines for Drinking-water Quality 2011* (4th edition). Geneva: World Health Organization. Available at:

[http://www.who.int/water\\_sanitation\\_health/publications/2011/dwq\\_guidelines/en/index.html](http://www.who.int/water_sanitation_health/publications/2011/dwq_guidelines/en/index.html).

WHO. 2014. Ebola virus disease: Key questions and answers concerning water, sanitation and hygiene.

[http://apps.who.int/iris/bitstream/10665/137181/1/WHO\\_EVD\\_WSH\\_14\\_eng.pdf?ua=1](http://apps.who.int/iris/bitstream/10665/137181/1/WHO_EVD_WSH_14_eng.pdf?ua=1).

WHO. 2015. Boil Water. Technical Brief. WHO/FWC/WSH/15.02. 2 pp.

[http://www.who.int/water\\_sanitation\\_health/dwq/Boiling\\_water\\_01\\_15.pdf?ua=1](http://www.who.int/water_sanitation_health/dwq/Boiling_water_01_15.pdf?ua=1).

WHO. 2016. Ebola virus disease. Fact sheet N°103, updated January 2016.

<http://www.who.int/mediacentre/factsheets/fs103/en/>.

WHO. 2017. Guidelines for drinking-water quality: fourth edition incorporating the first Addendum. Geneva: World Health Organization. 631 pp.

[http://www.who.int/water\\_sanitation\\_health/publications/drinking-water-quality-guidelines-4-including-1st-addendum/en/](http://www.who.int/water_sanitation_health/publications/drinking-water-quality-guidelines-4-including-1st-addendum/en/).

WRA. 2014. Ebola virus and drinking water. Member Update – October 2014. Water Research Australia. <http://www.waterra.com.au/publications/latest-news/2014/ebola-virus-and-drinking-water-member-update/w>.



# Chapter 8: Protozoal compliance

## Contents

|            |  |           |
|------------|--|-----------|
| <b>8.1</b> | <b>Introduction</b>  | <b>3</b>  |
| <b>8.2</b> | <b>Source water</b>  | <b>4</b>  |
| 8.2.1      | Introduction   | 4         |
| 8.2.2      | Approach to categorisation   | 7         |
| 8.2.3      | Catchment risk category approach                                   | 8         |
| 8.2.4      | Measurement of <i>Cryptosporidium</i> oocysts approach             | 9         |
| 8.2.5      | Comparison of protozoal risk assessment and oocyst monitoring data | 11        |
| 8.2.6      | Catchment categorisation review                                    | 13        |
| <b>8.3</b> | <b>The cumulative log credit approach</b>                          | <b>14</b> |
| 8.3.1      | Calculation of log credits   | 15        |
| 8.3.2      | Which treatment processes are additive for protozoal compliance?   | 15        |
| <b>8.4</b> | <b>Compliance</b>  | <b>20</b> |
| 8.4.1      | Pretreatment processes   | 21        |
| 8.4.2      | Coagulation processes  | 25        |
| 8.4.3      | Filtration processes   | 32        |
| 8.4.4      | Disinfection processes   | 47        |
| 8.4.5      | Other processes and other log credit determinations                | 63        |
| <b>8.5</b> | <b>Challenge testing</b>   | <b>67</b> |
| 8.5.1      | Using <i>Cryptosporidium</i> oocysts                               | 67        |
| 8.5.2      | Using microspheres   | 67        |
| 8.5.3      | Using naturally occurring bacteria                                 | 67        |
| 8.5.4      | Bag and cartridge filter challenge                                 | 68        |
| 8.5.5      | Membrane filter challenge  | 69        |
| 8.5.6      | UV appliance challenge   | 70        |
| 8.5.7      | General  | 72        |

|            |   |            |
|------------|---|------------|
| <b>8.6</b> | <b>Sampling and testing for protozoa and substitute compliance tests</b>  | <b>72</b>  |
| 8.6.1      | <i>Giardia</i> and <i>Cryptosporidium</i> testing   | 72         |
| 8.6.2      | Turbidity measurement   | 73         |
| 8.6.3      | Particle counting and particle monitoring   | 83         |
| 8.6.4      | Direct integrity test (membrane filtration)   | 85         |
| 8.6.5      | Indirect integrity testing (continuous)   | 87         |
| 8.6.6      | C.t values for chlorine dioxide and ozone   | 88         |
| 8.6.7      | UV intensity measurement  | 89         |
| 8.6.8      | Pressure differential   | 90         |
| 8.6.9      | Microscopic particulate analysis  | 90         |
| <b>8.7</b> | <b>Transgressions</b>   | <b>91</b>  |
| 8.7.1      | Response  | 91         |
| 8.7.2      | Reporting   | 92         |
|            | <b>References</b>   | <b>93</b>  |
|            | <b>Appendix: Guidance Notes: Interpretation of Catchment Protozoal Risk Category</b>  | <b>101</b> |
|            | Part 1: Surface waters  | 101        |
|            | Part 2: Bore water supplies   | 103        |
|            | Part 3: Five-yearly reassessment of protozoa risk category  | 106        |
|            | <b>List of tables</b>   |            |
| Table 8.1: | Mean spore removal for full-scale sedimentation basins  | 26         |
| Table 8.2: | Relationship between mean turbidity reduction during sedimentation and the percent of months when mean spore removal was at least 0.5 log | 27         |
| Table 8.3: | Studies of <i>Cryptosporidium</i> removal at different filtrate turbidity levels  | 31         |
| Table 8.4: | Results from studies of <i>Cryptosporidium</i> (or surrogate) removal by bag filters  | 37         |
| Table 8.5: | Results from studies of <i>Cryptosporidium</i> (or surrogate) removal by cartridge filters  | 43         |
| Table 8.6: | Methods and terminology for calculating the log inactivation credit when using ozone  | 50         |
| Table 8.7: | UV dose requirements for <i>Cryptosporidium</i> inactivation credits  | 62         |
| Table 8.8: | Summary of some methods for standardisation and verification of turbidimeters   | 80         |

|  |     |
|--|-----|
| Table 8A1: Log removal requirements for bore waters <10 m deep based on land use activities and soil / sub-surface material permeability | 105 |
| Table 8A2: Sub-surface media and soil categories   | 105 |

## Templates

|  |    |
|--|----|
| Template for assessing cartridge filter compliance   | 41 |
| Template for UV disinfection: evidence of validation | 55 |

# 8.1 Introduction

The Maximum Acceptable Value (MAV) for total pathogenic protozoa in drinking-water is less than 1 infectious (oo)cyst (cysts and oocysts) per 100 litres; see Table 2.1 of the *Drinking-water Standards for New Zealand 2005, revised 2008* (DWSNZ). Note that until the methodology for determining the viability or infectivity of detected (oo)cysts improves, results are to be reported as verified (oo)cysts.

*Cryptosporidium* and *Giardia* testing of drinking-waters:

- requires very large volumes to be filtered in order to achieve the sensitivity required
- requires two or more days to achieve a result
- requires very skilled laboratory personnel
- requires very expensive laboratory equipment
- does not allow large numbers of samples to be processed per day
- very few laboratories in New Zealand are accredited for this work.

Because it is impractical to demonstrate compliance with the protozoal MAV in the DWSNZ with statistical rigour, operational requirements for treatment processes known to remove or inactivate (oo)cysts are used instead. In many situations, when a monitoring test result fails to satisfy an operational requirement, the point of failure is readily identified; this would not be the case if testing directly for protozoa.

The operational requirements include:

- turbidity monitoring (or particle counting) for filtration processes
- direct integrity testing (for membrane filtration plants)
- indirect integrity testing, normally turbidity (for membranes, bags and cartridges)
- pressure differential for bag and cartridge filtration
- monitoring with UV intensity sensors
- C.t values for ozone and chlorine dioxide disinfection
- and in several cases the use of certificated or validated water treatment appliances is required.

This chapter discusses the compliance issues relating to the removal or inactivation of protozoa at the water treatment plant. Chapters 12–15 discuss the management and operational aspects of pre-treatment, coagulation, filtration, and disinfection processes respectively.

If the compliance criteria for *Cryptosporidium* are met, it is assumed that other protozoa should not present health issues in that drinking water.

If water leaving the treatment plant satisfies the appropriate protozoa compliance criteria, and if the bacterial compliance criteria for water in the distribution system are satisfied, then it is considered that it is unlikely that protozoa will present a health risk in the distribution system.

Some more general aspects of microbiology and related illnesses are discussed in Chapter 5: General Microbiological Quality.

Water sources and their selection are covered in Chapters 3 and 4, although section 8.2 of this chapter deals with source water protozoal risk categorisation based on *Cryptosporidium* occurrence or catchment characteristics.

Much of the early work was carried out in the UK after various outbreaks of cryptosporidiosis. Badenoch produced the first major reports in 1990 and 1995, with recommendations, and Bouchier (1998) updated these.

WHO (2004a) discusses treatment processes suitable for pathogen control. The WHO (in 2006) produced WHO Guidelines for Drinking Water Quality: *Cryptosporidium* which discusses many issues related to this protozoan, and includes an extensive bibliography.

Health Canada (2012) released enteric protozoa guidelines, also based on the USEPA LT2ESWTR.

Details of specific protozoa (not just *Cryptosporidium* and *Giardia*) are covered in the datasheets.

## 8.2 Source water

### 8.2.1 Introduction

The requirements for protozoal compliance with the DWSNZ are based on a cumulative log credit approach explained in section 5.2 of the DWSNZ and section 8.3 of the Guidelines. To define the level of treatment required for a water supplier to demonstrate protozoal compliance with the DWSNZ, the raw water must be categorised with respect to the risk presented by the concentrations of protozoa in the water. This can be done by either assessing protozoal risk, or by measuring *Cryptosporidium* oocyst numbers. The categorisation determines the minimum number of protozoal log credits the supply's treatment processes must achieve. Section 5.2.1 of the DWSNZ specifies how the categories are defined, and the way in which the source

water quality is to be evaluated. The oocyst concentrations that define the risk categories are based on the boundaries used by the USEPA to define the 'bin classifications' contained in their proposed *Long Term 2 Enhanced Surface Water Treatment Rule* (USEPA 2003a), and confirmed in their final rule (USEPA 2006a).

*Cryptosporidium* and *Giardia* sampling and testing is discussed in section 8.6.1. The analytical procedure to be used is based on Method 1623 (USEPA 2005b). See also *Source Water Monitoring Guidance Manual for Public Water Systems for the Long Term 2 Enhanced Surface Water Treatment Rule* (USEPA 2006b). Laboratories conducting protozoa testing for compliance purposes are to have IANZ accreditation for this work.

Ideally, protozoal categorisation would only be based on the results of monitoring oocysts. Water suppliers made it abundantly clear during the DWSNZ consultation process that they felt this would be too expensive; hence the introduction of the catchment risk category approach for supplies <10,000 population.

In recognition of the relatively high cost of analysing samples for *Cryptosporidium*, the USEPA (2003a) explored the use of indicator criteria to identify raw waters that may have high levels of *Cryptosporidium* occurrence. Data were evaluated for possible indicator parameters, including faecal coliforms, total coliforms, *E. coli*, viruses, and turbidity. *E. coli* was found to provide the best performance as a *Cryptosporidium* indicator in source waters, and the inclusion of other parameters like turbidity was not found to improve accuracy. As a consequence, the DWSNZ 2005 had also adopted some *E. coli* monitoring of source water. The basis for this was not strong, so the requirement for *E. coli* monitoring of source waters was dropped from the 2008 revision.

Because bore waters are often free from microbiological contamination, their protozoal log credit requirement is assessed in a different manner than used for surface water. Protozoal risk categories for bore waters will be one of 0, 2, 3, 4 or 5 log credits; see section 8.2.2. Source water protozoal risk categories for surface supplies will be one of 3, 4 or 5 log credits. Secure bore waters are considered to be free from protozoa. Bore water security is discussed in Chapter 3.

In effect, there is a default for surface waters of 4 logs. If no towns are in the catchment or the effects of agricultural wastes are minimal, this drops to 3 logs; with excessive farm or human wastes 5 log removals could be required. Note however that no New Zealand source water is expected to need 5 log removals. If a source water is so bad that 5 logs are really needed, there is a huge incentive to change the source or clean up the land use practices.

One DWSNZ draft attempted to reduce the log credit requirement for lakes/reservoirs, but that became bogged down in discussions about (oo)cyst settling rates, the effect of sunlight and predators, water temperature, retention time, stratification, mixing, and depth of abstraction valve, etc.

It was assumed that the quality of springs and very shallow bores may be no better than that of a surface water passing through <10 m of gravel, hence the 3–5 log removal requirement was retained. The 10–30 m deep group of bores was allowed 1 log credit requirement less than the 'default' on the grounds that the quality would improve as the water percolated through the extra depth of soil. The DWSNZ Expert

Committee couldn't reduce the log credit requirement any further for non-secure bore waters because it is well known that die-off of micro-organisms is less prominent in gravel, limestone and basalt structures due to their relatively rapid transport rates. It was accepted that any large groundwater user that felt they were being asked to meet too many log credits would choose to prove their point by monitoring for oocysts – that would be cheaper than installing extra water treatment plant. The intention was that use of unconfined shallow bores/springs was to be discouraged; any > 10 m should only need UV disinfection at most.

Massey University, for the MoH, has collected 720 samples from 20 sites across New Zealand, ie, 36 quarterly samples per site over a nine-year period (September 2009–January 2019). Results (rounded) can be summarised as follows:

| <b><i>Cryptosporidium</i></b> |  |               |
|-------------------------------|--|---------------|
| <b>Sample group</b>           | <b>% samples containing <i>Cryptosporidium</i></b> |               |
| Groundwater/springs           | 0  |               |
| Bush catchments               | 1  |               |
| Intermediate rivers           | 1  |               |
| Lowland rivers                | 42   |               |
| <b><i>Giardia</i></b>         |  |               |
| <b>Sample group</b>           | <b>% samples containing <i>Giardia</i></b>         |               |
| Groundwater/springs           | 0  |               |
| Bush catchments               | 3  |               |
| Intermediate rivers           | 6  |               |
| Lowland rivers                | 58   |               |
| <b><i>E. coli</i></b>         |  |               |
| <b>Sample group</b>           | <b>% samples containing <i>E. coli</i></b>         |               |
| Groundwater/springs           | 7  |               |
| Bush catchments               | 84   |               |
| Intermediate rivers           | 88   |               |
| Lowland rivers                | 100  |               |
| <b>Sample group</b>           | <b>arithmetic mean</b>                             | <b>median</b> |
| Groundwater/springs           | 0.2  | 0             |
| Bush catchments               | 23   | 3.5           |
| Intermediate rivers           | 71   | 17            |
| Lowland rivers                | 277  | 96            |
| <b><i>Campylobacter</i></b>   |  |               |
| <b>Sample group</b>           | <b>% samples containing <i>Campylobacter</i></b>   |               |
| Groundwater/springs           | 2  |               |
| Bush catchments               | 10   |               |
| Intermediate rivers           | 21   |               |
| Lowland rivers                | 58   |               |

Some observations to date:

- Most *Cryptosporidium* oocysts in the 154 lowland river samples were found in autumn and spring. None were found in February and one was found in January; seven were found in June/July and none in August.
- The Waikato River at Tuakau and at Hamilton, the Oroua River at Feilding and the Waiorohi Stream (Oropi Road, Tauranga) contained protozoa in about half the samples. The numbers found indicate that these sites would not be required to achieve more than 3-log removal of *Cryptosporidium* oocysts.
- None of the 184 groundwater/spring sites contained protozoa, despite being selected because they were shallow or not secure, and had a previous history of containing *E. coli*.
- Only about 1–2% of bush catchment and intermediate rivers samples contained *Cryptosporidium*.

## 8.2.2 Approach to categorisation

### 8.2.2.1 Bore waters

#### a) Bores drawn from confined aquifers

A bore of any depth drawing from a confined aquifer can be given interim security if it satisfies bore water criterion 1 and bore water criterion 2 (see section 4.5 of DWSNZ). Secure and interim secure bores are deemed to satisfy the protozoal compliance criteria, ie, no protozoal log credits required. The secure status is gained/maintained so long as bore water criterion 3 (absence of *E. coli*) is satisfied. Note that it may be difficult to show that bores up to 10 m deep are drawing from confined aquifers, and it may be difficult for them to satisfy bore water criterion 1 and bore water criterion 3; however, they are included for completeness.

Water drawn from an aquifer that is considered to be confined but does not satisfy (or has not been assessed against) bore water criterion 1 and/or bore water criterion 2, is deemed to be equivalent to water drawn from an unconfined aquifer.

#### b) Bores drawn from unconfined aquifers (or if status of aquifer unknown)

A bore drawing from an unconfined aquifer more than 10 m below the ground surface can be given interim security if it satisfies bore water criterion 1 and bore water criterion 2, and some other conditions: see section 4.5.1 of the DWSNZ. Secure and interim secure bores are deemed to satisfy the protozoal compliance criteria. Note that bores drawing from unconfined aquifers are a lot less likely to satisfy bore water criterion 1, and consequently may fail to satisfy bore water criterion 3.

Chapter 3: Source Waters, section 3.2.4 has further discussion on establishing the security of bore water supplies.

Tables 5.1a and 5.1b in the DWSNZ have confused some readers. The following applies for the situations where bore water criterion 1 cannot be or is not satisfied.

| Depth (m) | Protozoal log credit requirement  |
|-----------|---|
| <10       | Equivalent to surface water, so 3–5 log removals needed, see section 8.2.2.2  |
| 10–30     | 3 log credits required during the five-year <i>E. coli</i> proving period   |
| 30+       | If hydrogeological evidence suggests that the bore water is likely to be secure, then interim secure status may be granted, see (a), otherwise 2 log credits required, provided bore water criterion 2 is satisfied |

### 8.2.2.2 Surface waters

There are two approaches for determining the protozoal risk categorisation of surface waters, see DWSNZ sections 5.2.1.1 and 5.2.1.2, and both require a five-yearly review, see section 8.2.6.

#### a) Catchment risk category approach (Guidelines section 8.2.3)

This is the default option for supplies serving a population up to 10,000, and is based on assessing the perceived risk related to the surface water catchment categories as defined in DWSNZ Table 5.1a. Should a water supplier consider the assignment of the log credit requirement to be inappropriate, any appeal must be supported by data obtained by monitoring *Cryptosporidium* (see b).

#### b) Measurement of *Cryptosporidium* oocysts approach (Guidelines section 8.2.4)

This is the default option for supplies serving a population over 10,000, and is based on matching the mean oocyst concentration with the log credit categories in Table 5.1b of the DWSNZ. Should the water supplier consider this approach to have led to an inappropriate log credit requirement, the log requirement based on the perceived risk related to the surface water catchment categories as defined in section 5.2.1.1 and Table 5.1a may be adopted.

Note that all water suppliers conduct catchment assessments as part of their PHRMP (now Water Safety Plan or WSP) process, and this is an ongoing process. Catchment assessments are intended to consider all aspects that may impact on the quality of the raw water and the security of the supply. Information from the initial catchment assessment will have been used in the selection of the water treatment plant site and design. Protozoal risk categorisation only considers those activities that may affect the number of *Cryptosporidium* oocysts.

## 8.2.3 Catchment risk category approach

The catchment risk categorisation procedure involves a survey of the catchment. The form for recording the survey results appears in Appendix 3 of the DWSNZ. The DWA will assign the log credit requirement once the catchment assessment has been completed. Where appropriate the assignment process will make use of the *Cryptosporidium* monitoring results provided by the > 10,000 supplies.



When water is drawn from more than one catchment, the catchment with the greatest protozoal risk will determine the log credit requirement for the treatment plant.

This risk categorisation approach should provide an evaluation of the catchment that identifies all likely sources of *Cryptosporidium* oocysts in the raw water, even if the frequency at which these events occur is low. Risk assessment is a difficult tool to use meaningfully when the relationships between activities in the catchment and raw water quality are not understood. The water supply needs to be safe to drink at all times, therefore the catchment survey must take into account the conditions most likely to challenge the treatment process.

Scottish Water (2003) devised a scoring system for assessing water supply catchments in response to *Cryptosporidium* problems. This publication indicates their weighted assessment of the various impacts due to *Cryptosporidium*, and has some relevance to New Zealand conditions so should provide some useful background reading. Also, drinking water assessors have produced Guidance Notes which is more detailed than Appendix 3 of the DWSNZ. These Guidance Notes are appended to this chapter.

## 8.2.4 Measurement of *Cryptosporidium* oocysts approach

Although this approach seems to have the advantage of providing quantitative information for the categorisation, the mean oocyst concentration will depend on the frequency of sampling and whether the collection times coincide with episodes of poor or good water quality. Samples taken too infrequently may miss poor water quality episodes when oocyst counts are high. This could result in an inadequate level of treatment being provided. Conversely, excess treatment may be indicated.

To achieve a balance between accuracy and costs, the monitoring programme must comprise at least 26 samples collected over a 12-month period at approximately equal time intervals to attempt to ensure representative samples and minimise seasonal bias. The samples must be tested quantitatively for *Giardia* cysts and *Cryptosporidium* oocysts. Subject to laboratory and delivery services, samples should be taken to cover every day of the week and must cover at least Monday to Friday three times during the sampling programme; this has been discussed further in Chapter 17: Monitoring, section 17.2. The results from the monitoring programme must be reported to the DWA who will assign the log credit requirement.

The DWA must be informed of the year's monitoring plan before it starts, and any changes to it must be agreed with the DWA before the changes are made. This is to avoid samples being taken intentionally at times when the concentrations of oocysts in the raw water are expected to be low.

The sampling location must meet a number of criteria (see DWSNZ section 5.2.2). These are designed to ensure that the samples are representative of the water quality entering the first treatment process for which log credits will be claimed. If water taken from the source at the point of abstraction does not undergo any changes in quality before treatment, then the untreated water may be obtained from this location. Where water is drawn from multiple sources, samples must be taken from the combined flow.

DWSNZ section 5.2.1.3 specifies the requirements for when waste water is recycled to the head of a treatment plant. Poor quality recycle water, and large or sudden discharges of recycle water will challenge the treatment process. That is why the DWSNZ require the instantaneous return rate not to exceed 10 percent of the plant inflow, and the recycle water turbidity is to be measured to show that the solids/liquid separation process is operating effectively. The DWSNZ did not specify turbidity limits/durations because that would be too prescriptive, instead turbidity monitoring was adopted that would show a water supplier when a suitable response is required, eg, to divert to waste. AWWA (2001) recommends that the return rate target be <5%, that it be continuous and well mixed, and shut off when its turbidity exceeds 20 NTU. Interestingly, the Southern Milwaukee Water Treatment Plant was recycling filter backwash water at the time of their massive *Cryptosporidium* outbreak; they ceased that practice (McKenzie et al 1994).

If any water supplier measures oocysts with a recovery of around 40 percent in the raw water, but <10 percent for recycle water, they should attend to their solids/liquid separation process before wasting too much time collecting dubious data. A water supplier that recycles their wastes in accordance with the requirements of section 5.2.1.3 of the DWSNZ would be unlikely to require any more log credits than the raw water requires.

DWSNZ Table 5.1b refers to the mean value; this is the arithmetic mean. Laboratories must achieve a detection limit of better than 0.75 oocysts/10 litres. This is to ensure that there is no misclassification of source waters because the sensitivity of the technique was inadequate. When calculating the mean oocyst concentration, results that have been reported as less than the detection limit, should be assigned an arbitrary value of zero.

USEPA (2003a, 2006a) stated “Spike data indicate that average recovery of *Cryptosporidium* oocysts with Methods 1622 or 1623 in a national monitoring program will be approximately 40 percent. Studies on natural waters for *Cryptosporidium* using both Method 1623 and a method (cell culture-PCR) to test for infectivity suggested that 37 percent of the *Cryptosporidium* oocysts detected by Method 1623 were infectious”. Consequently, USEPA accepted the “recommendation that monitoring results should not be adjusted to account for either recovery or the fraction that is infectious”.

However, for the purpose of protozoal risk categorisation in the DWSNZ, oocysts numbers should be reported after normalising to a 40 percent recovery rate. Because individual recoveries can commonly vary from 15–55 percent, the normalising approach was considered to be fairer and more consistent. Therefore, if a test result of 0.48 oocysts per 10 L was obtained in a batch that achieved 30 percent recovery, the result to be reported =  $0.48 \times 40/30 = 0.64$ . Conversely, had the recovery been 56 percent, the reported result should =  $0.48 \times 40/56 = 0.34$ .

To assist in understanding the relationships between catchment activities and *Cryptosporidium* oocysts levels, it would be helpful to collate the following additional information when samples are collected:

- 1) weather conditions, or the operation of irrigation systems, in the catchment or recharge zone on the day the sample was collected and on each of the two previous days
- 2) for surface waters, the turbidity, a description of the source water quality (visual appearance) and how this compared with the water quality during fine weather, and river flow/river height
- 3) for all sources, the date and time of sampling
- 4) which sources are in use at the time of sampling if the treatment plant is fed from multiple sources
- 5) other factors that might influence the level of raw water contamination, such as irregular or seasonal land-use activities, and precedent weather.

## 8.2.5 Comparison of protozoal risk assessment and oocyst monitoring data

Water suppliers that consider the original protozoal risk categorisation to be inappropriate are permitted to use the other approach. It is possible that in doing so, the conclusion from each approach may be different. Similarly, it may be possible that the five-yearly review produces a different outcome. Before rejecting one or other of the conclusions, the reasons for such discrepancies should be identified. The most likely reasons for a discrepancy are:

- a) monitoring oocysts has missed high risk but low frequency events
- b) the catchment risk assessment has omitted, or underestimated the importance of, a contaminating activity in the catchment, or land use changes have occurred
- c) monitoring oocysts has coincided with atypical events
- d) the risk assessment has placed too high an importance on a contaminating activity in the catchment.

When considering protection of public health, reasons a) and b) are a primary concern. Moreover, if b) is the reason for the discrepancy, remedial actions to reduce the risk to supply may be misdirected because important sources of contamination may have been overlooked.

A review of the weather conditions and the appearance of the source water, when samples for *Cryptosporidium* testing were taken is a helpful place to start in investigating the cause of discrepancies. The five additional pieces of information discussed in the previous section that should be collected when samples are taken will assist in this investigation.

Comparison of this information with what is known about potential sources of contamination in the catchment may explain the reason for measured oocyst concentrations being lower or higher than expected on the basis of the risk assessment. For example, high oocyst concentrations in the absence of rain points to the source of contamination not being reliant on rain to transport contaminants to the receiving water, eg, stock had direct access to the water source, or human wastes are entering the source water. Sampling dates/times may help to ascertain whether an unexpected event, such as an upstream wastewater treatment malfunction, may have contributed to the poor quality of the raw water.

A review of the protozoal risk categorisation questionnaire to determine which activities contributed most to the overall risk score may help to answer questions such as:

- to what degree are these likely to have been influenced by rain, and was it raining about the time of sampling?
- are these activities likely to contribute intermittently to poor water quality, and therefore were they likely to have been significant at the times when samples were taken?

Land use can have a large impact on water quality. Check matters such as whether:

- dairy conversions have been occurring
- stock numbers have been as expected
- calving has taken place
- stock has been moved
- animal wastes have been irrigated
- animal waste treatment systems have performed poorly
- riparian strips and fences installed or damaged
- any stock have direct access the natural water in the catchment
- pasture was overgrazed before heavy rain fell.

Information acquired during the investigation, or simply from undertaking the risk assessment, may highlight actions that could be taken to reduce the level of risk to the supply. For example, high contaminant levels in the raw water may occur on an infrequent basis and consequently may not become evident from monitoring. These low-frequency events may challenge the treatment plant's ability to reduce oocyst concentrations to an acceptable level, even if the treatment plant is compliant with the DWSNZ. Knowing the cause of these events could provide a guide to remedial actions needed in the catchment. Water suppliers would be expected to address such matters in their PHRMPs.

## 8.2.6 Catchment categorisation review

In the DWSNZ, section 5.2.1.1 Catchment risk category approach includes: “Reassessments must be made at least five-yearly intervals”. Section 5.2.1.2 *Cryptosporidium* monitoring includes: “The protozoa monitoring programme must be repeated at least five-yearly intervals”. Taken literally, this could involve an unnecessarily expensive process. The real intent is explained below in a) or b).

Also, a source water that receives a higher level of treatment than the minimum requirement only needs to be reviewed if the source water quality is likely to deteriorate markedly. For example, some water suppliers have chosen to process a 3-log source water in a 4-log removal water treatment plant. Even if the source water quality deteriorated, it is highly improbable that it could become a 5-log source water.

If the review suggests the log credit requirement has increased resulting in the need to upgrade the water treatment process, the water supplier shall address how and when they will do this in their PHRMP (WSP).

### a) Catchment risk category approach

Water suppliers whose source water has a risk of requiring an increase in the number of protozoal log removals should be looking at their catchment on a regular basis, including attempting to control catchment land use through the regional council consent process, using NES where appropriate. These activities should be described in their PHRMP. If such a water supplier believes the risk has increased, they should check whether there is something they can do about it, such as modifying their intakes or improving their water treatment process – they should want to do that to ensure that their drinking water remains safe to drink – they should not wait until the five-yearly review is due.

Note: paragraph 2 in section 5.2.1.1 of the DWSNZ states “Should the assignment of the log credit made by the Ministry be considered inappropriate, any appeal (section 1.9) must be supported by data obtained by monitoring *Cryptosporidium* (section 5.2.1.2)”. It is reasonable to assume that this approach may also apply to the five-yearly reviews.

### b) *Cryptosporidium* monitoring

The words “The protozoa monitoring programme must be repeated at least five-yearly intervals” can be interpreted more reasonably as:

The protozoa monitoring programme must be repeated in response to:

- a change in catchment activities that indicates a likely increase in oocyst numbers; or
- an intention by the water supplier to employ a protozoal treatment with a reduced protozoal log removal rating; or
- an outbreak of waterborne protozoal infection linked to the water supply that is not explained by a lapse in protozoal treatment.

In the extreme (but fairly common situation) of a bush catchment, a water supplier may need to do no more than state that “the raw water is still being drawn from a bush catchment with no agricultural activity or human wastes”. It could be helpful if they operate an ongoing predator control programme.

If the original log removal requirement had been based on protozoa numbers and the review (also using protozoa numbers) suggests more log credits are required, then that means the protozoa risk has increased, OR it was simply ‘bad luck’ when the latest samples were collected (or good luck with the first). How this is handled will depend on the results. For example:

- if the original results produced mean oocysts of say 0.70 per 10 L and the review mean is 0.80, it could be suggested sampling continue until a clearer pattern has emerged
- but if the results went from say 0.20 per 10 L to 1.25 per 10 L, there can be little to argue about, the source water has certainly changed from 3-log to 4-log
- if most samples were ‘less thans’ and one was ‘large’ for no obvious reason, perhaps it should be suggested that sampling continues until there is more confidence that the ‘large’ result was really an outlier.

Note: section 5.2.1.2 says in the second paragraph: If the water supplier considers the *Cryptosporidium* monitoring option results in an inappropriate log credit requirement, the catchment risk categorisation approach as defined in section 5.2.1.1 and Table 5.1a may be adopted. It is reasonable to assume that this approach may also apply to the five-yearly reviews.

## 8.3 The cumulative log credit approach

Section 5.2 of the DWSNZ explains the cumulative log credit approach for the removal or inactivation of protozoa. Editions prior to 2005 did not take account of the additive effect of a series of treatment processes on protozoa removal.

The cumulative effect of successive treatment processes can be calculated by adding the log credits of the qualifying processes that are in continuous use. Using the log credit approach allows the cumulative effects to be added, because, arithmetically, it is not possible to add percentages. See Table A1.2 in DWSNZ for the conversion table from percentage removal to logarithms. Some examples of the calculations follow.

## 8.3.1 Calculation of log credits

Example 1: say the influent contained 1000 'things' per litre and the effluent contained 100:

$$\frac{1000 - 100}{1000} = \frac{900}{1000} = 0.90 = 90\% \text{ removal}$$

$$\log 1000 - \log 100 = 3.0 - 2.0 = 1 \text{ log removal}$$

Example 2: say the influent contained 100,000 'things' per litre and the effluent contained 10:

$$\frac{100,000 - 10}{100,000} = \frac{99,990}{100,000} = 0.9999 = 99.99\% \text{ removal}$$

$$\log 100,000 - \log 10 = 5 - 1 = 4 \text{ log removal}$$

Example 3: say the influent contained 1000 'things' per litre and the effluent contained 30:

$$\frac{1000 - 30}{1000} = \frac{970}{1000} = 0.97 = 97\% \text{ removal}$$

$$\log 1000 - \log 30 = 3.00 - 1.48 = 1.52 \text{ log removal (round to 1.5)}$$

Note: Using a spreadsheet, eg, key in =log10(30) to get the log of 30 (ie, = 1.4771).

Example 4: raw water turbidity = 0.96 NTU and settled water = 0.51 NTU:

$$\frac{0.96 - 0.51}{0.96} = \frac{0.45}{0.96} = 0.469 = 46.9\% \text{ removal}$$

$$\begin{aligned} \log 0.96 - \log 0.51 &= 0.0177 - (-0.2924) &&= -0.0177 + 0.2924 \\ &&&= 0.2747 \text{ (round to 0.27) log removal} \end{aligned}$$

The negative signs make the arithmetic a little more complex, so percentages have been adopted in the DWSNZ section 5.4.1 for the coagulation/sedimentation process not using rapid gravity (or pressure) granular particle filtration.

Section 5.2.1 of the DWSNZ and section 8.2 of the Guidelines explain how the source water protozoal risk categories are determined. The concept of source water categorisation is quite simple: the dirtier the water, the greater the amount of treatment needed. This is called risk-based. The result is that once a water source has been tested and categorised, water suppliers will know how many log credits are required in order to comply with the protozoa criteria in the DWSNZ. They can then choose a process or combination of processes that suits their particular requirements. See Chapter 4: Selection of Water Source and Treatment, section 4.5 for discussion relating to treatment processes other than for protozoa.

## 8.3.2 Which treatment processes are additive for protozoal compliance?

Section 5.2.3 of the DWSNZ explains which treatment processes can be combined for the purposes of being awarded log credits. The processes discussed below may be preceded by qualifying bank filtration (0.5 or 1.0 log credit).

## 1a) Coagulation-based processes (using traditional rapid granular media filtration)

- Coagulation/sedimentation/filtration (3.0 log credit), or
- Coagulation/direct sand filtration (2.5 log credit).

These processes may be followed by:

- enhanced combined filtration (0.5 log credit), or
- enhanced individual filtration (1.0 log credit), or
- secondary granular filtration (eg, sand or carbon) (0.5 log credit).

## 1b) Coagulation based processes (using membrane filtration)

- Coagulation/sedimentation/rapid granular media filtration (3.0 log credit), or
- Coagulation/direct rapid granular media filtration (2.5 log credit), or
- Coagulation/sedimentation without rapid granular media filtration (0.5 log credit).

These processes (1a and 1b) may be followed by membrane filtration (for log credits, see DWSNZ section 5.11, almost entirely 4-log).

## 1c) Disinfection following a process that uses coagulation

Steps included in 1a) and 1b) can be followed by:

- chlorine dioxide disinfection (dose dependant log credit), or
- ozone disinfection (dose dependant log credit), or
- UV disinfection (dose dependant log credit).

Note that these disinfectants can be used singly, or in combination, up to 3 log credits.

## 2a) Filtration processes without coagulation (using a single filtration process)

- Diatomaceous earth (2.5 log credit), or
- Slow sand (2.5 log credit), or
- Membrane filtration (for log credit, see DWSNZ section 5.11, most likely 4-log), or
- Cartridge filtration (2.0 log credit), or
- Bag filtration (1.0 log credit).



## 2b) Any option in step 2a can be followed by

- Chlorine dioxide disinfection (dose dependant log credit), or
- Ozone disinfection (dose dependant log credit), or
- UV disinfection (dose dependant log credit).

Note that these disinfectants can be used singly, or in combination, up to 3 log credits.

## 3a) Filtration processes (using two filtration processes)

- Diatomaceous earth (2.5 log credit), or
- Slow sand (2.5 log credit).

These processes may be followed by:

- membrane filtration (for log credit: see DWSNZ section 5.11, most likely 4-log), or
- cartridge filtration (0.5 log credit), or
- bag filtration (0.5 log credit).

## 3b) Any option in step 3a can be followed by

- Chlorine dioxide disinfection (dose dependant log credit), or
- Ozone disinfection (dose dependant log credit), or
- UV disinfection (dose dependant log credit).

Note that these disinfectants can be used singly, or in combination, up to 3 log credits.

## 4) Disinfection only

- Chlorine dioxide disinfection (dose dependant log credit), or
- Ozone disinfection (dose dependant log credit), or
- UV disinfection (dose dependant log credit).

Note that these disinfectants can be used singly, or in combination, up to 3 log credits.

Log credits for combinations not shown above may be obtained by application to the Ministry of Health. See also DWSNZ section 5.17 and section 8.4.5 of the Guidelines.

When filters are not used in a primary role they do not qualify for the full number of log credits. For example, coagulation/sedimentation/sand filtration earns 3.0 log credits, and coagulation plus sedimentation without filtration earns 0.5 log credits, implying that a sand filter used in its primary role is worth 2.5 log credits. But used as a secondary filter in a process that includes coagulation, it earns only 0.5 log credits. The same approach has been adopted for when cartridge and bag filters are used in a secondary role.

Credits for filters used following the primary filter are only awarded if they are finer than the primary filter. Sand filters do not earn any log credits once all (or almost all) the coagulant has been removed, eg, after membrane filtration. Sand filters operate mainly by charged particles (associated with floc) adsorbing to the sand grains, which is how particles that are theoretically small enough to pass through the filter are removed. Without coagulation there is little adsorption; filtration in that situation is only by straining.

The USEPA (2003a, 2006a) states that since the available data are not sufficient to support the C.t calculation for an inactivation level greater than 3 log, total disinfection inactivation credits are limited to less than or equal to 3 log. If one disinfection system is operated such that 3 log inactivation of *Cryptosporidium* is being achieved, then it is not likely that a second disinfectant (also being dosed at sufficient to achieve 3 logs) would remove any (or many) more oocysts. So using two disinfectants would not realistically be additive, ie, it wouldn't deserve 6 log credits. The second disinfectant is certainly an additional barrier, but beyond 3 log, it is not an additive one. A second disinfectant doesn't necessarily improve the inactivation of *Cryptosporidium* oocysts in the water (unless of course one of the barriers fails, but while it's broken down it earns zero credits).

However, using filtration plus disinfection does constitute two barriers, two completely different treatment processes, so these are additive.

The following examples illustrate how to match treatment processes to the log credits required by the source water categorisation:

### To earn 2 log credits

Non-secure bore waters drawn from an unconfined aquifer more than 30 m below the surface need only 2 log credits to satisfy the protozoa compliance criteria. This can be achieved by filtering the water, eg, using diatomaceous earth or cartridge filtration. It can also be achieved by disinfecting at the appropriate dose of UV, ozone or chlorine dioxide. Note however, that if UV disinfection is being used for protozoal compliance without chlorine, the UV dose will need to be equivalent to 40 mJ/cm<sup>2</sup> in order to achieve bacterial compliance criterion 5, see section 4.3.5 of the DWSNZ.

### To earn 3 log credits

Most surface water supplies, non-secure bore waters less than 30 m deep, and springs should only need to achieve 3 protozoal log credits (refer section 8.2). Of course, water suppliers may want the security or back-up of achieving more than the minimum requirement.

- a) Source waters without colour and with fairly consistently low turbidity, such as non-secure bore waters and upland streams in catchments without much bush or peaty soil, probably do not need to use a chemical coagulation processes. Subject to meeting all the requirements of the DWSNZ, they may choose to:

- dose enough ozone and/or UV light to satisfy the C.t values in Tables 5.6 or 5.7 of the DWSNZ to earn 3 log credits
  - use bag filtration (1 log) plus enough ozone and/or UV to earn 2 more log credits
  - use cartridge filtration (2 log) plus enough ozone and/or UV to earn 1 log credit
  - use diatomaceous earth filtration (2.5 log) plus a low dose of UV to earn another 0.5 log credits
  - use bank filtration (0.5 or 1.0 log credits) plus cartridge filtration (2 log) plus a low UV dose.
- b) Source waters that need or choose to use coagulation to remove colour or where the turbidity is too high for filtration-only systems may:
- use alum/PAC coagulation with sedimentation/DAF plus rapid granular media filtration so that water leaving each filter is less than 0.30 NTU (3 log)
  - use direct filtration (2.5 log) plus enhanced filtration (0.5 log if the combined filtered water turbidity is less than 0.15 NTU)
  - use coagulation with direct rapid granular media filtration (2.5 log) plus a low dose of UV, ozone or chlorine dioxide to earn another 0.5 log
  - use diatomaceous earth filtration (2.5 log) plus enough ozone (which may remove some of the colour too) to earn another 0.5 log.

## To earn 4 log credits

Only a few New Zealand source waters will probably need to achieve 4 log removals. If the water is not highly coloured or turbid, this can be achieved simply by increasing the disinfectant dose in the last four examples in a) or the last two examples in b).

A number of options are available for source waters that are not so clean. Some are:

- use alum/PAC coagulation with sedimentation/DAF plus rapid gravity sand filtration (3 log) plus a fairly low dose of UV and/or ozone to earn another 1 log
- use coagulation with direct filtration (2.5 log) plus enough UV and/or ozone to earn another 1.5 log credits
- use bank filtration (0.5 or 1.0 log) with direct filtration (2.5 log) plus enough UV and/or ozone to earn another 0.5 or 1.0 log credits
- use coagulation, sedimentation plus filtration (3 log) plus enhanced filtration (0.5 log if the combined filtered water turbidity is less than 0.15 NTU), plus a low dose of UV, ozone or chlorine dioxide to earn another 0.5 log
- use membrane filtration, which will probably earn 4 log credits, along with whatever other treatment is necessary to achieve the desired filtered water quality.

These are just examples. As can be seen, many treatment processes can be combined in order to achieve the required number of log credits.

Note that although chlorine is not effective in the inactivation of *Cryptosporidium*, it is still a very effective disinfectant for other micro-organisms. Subject to C.t values, chlorine can inactivate *Giardia* cysts. It also allows a residual to pass into and persist through the distribution system. Its use is still very highly recommended.

### To earn 5 log credits

It is extremely unlikely that any source water in New Zealand would require 5-log treatment. If it did, it is strongly recommended that a new source water be found.

However, water is abstracted from some very dirty rivers overseas, such as the lower reaches of the Rhine. Treatment there could include bank filtration, coagulation, membrane filtration, disinfection with ozone, followed by biologically active filters, and then chlorinated to maintain a residual in the distribution system. This treatment train could earn 6–9 log credits!

## 8.4 Compliance

This section offers guidance on compliance issues for each treatment process that earns protozoal log credits, plus some that don't. The concept is based on the USEPA (2003a, 2006a) *Long Term 2 Enhanced Surface Water Treatment Rule* (known as the LT2ESWTR). Additional information is available in the *Long Term 2 Enhanced Surface Water Treatment Rule, Toolbox Guidance Manual Review Draft* (USEPA 2009). Chapters 12–15 of the Guidelines discuss the technical and operational aspects of these treatment processes.

Because the approach adopted in the DWSNZ for demonstrating protozoal compliance is a relatively new concept, some of the background studies that the USEPA used in developing the log credits and associated criteria have been included in the following sub-sections. Some of the studies give useful information about treatment performance and efficiency. The World Health Organization (eg, WHO 2011) is moving in the same direction, being a logical extension of their long-held belief in the value of multiple barriers.

Section 8.4.5 covers treatment processes not included in the DWSNZ.

Water supplies using any of the following removal or inactivation processes, but not for the purpose of gaining protozoa log credits, do not need to satisfy the protozoal compliance criteria.

## 8.4.1 Pretreatment processes

### 8.4.1.1 Bankside filtration

#### Process description

Bank filtration is a water treatment process that makes use of surface water that has naturally infiltrated under the ground via the riverbed or bank(s) and is recovered via a pumping well. Bank filtrate is water drawn into a pumping well from a nearby surface water source which has travelled through the subsurface, either vertically, horizontally or both, mixing to some degree with other groundwater.

It is envisaged that the greatest benefit of this process may be for water suppliers using turbid or flashy rivers.

Operational aspects of bankside filtration and infiltration galleries are discussed in Chapter 12: Treatment Processes, Pretreatment, section 12.3.1. Refer also to Chapter 4 of the review draft LT2ESWTR Toolbox Guidance Manual (USEPA 2009) which discusses issues related to bank filtration.

#### DWSNZ criteria

See section 5.3 of the DWSNZ for the protozoal compliance requirements that need to be satisfied in order to qualify for the 0.5 or 1.0 log credit. If the bank filtration process is not being operated for the purpose of protozoal compliance, these requirements do not need to be met.

The DWSNZ (requirement 5 in section 5.3.1) state that for manual sampling:

- there is documented evidence that the turbidity (of the abstracted water) does not exceed 2.0 NTU during the week after a flood.

This does not require on-going turbidity measurement. A survey of turbidity levels (a minimum of 30 data points) and river flows/depths over a week following a major flood is sufficient; the rainfall leading up to the flood should be recorded as well. The survey may need to be repeated if a large flood causes the river to flow down a new channel.

Wells near rivers do not always deliver river water. It is possible that they intercept shallow groundwater (most probably from an unconfined aquifer), and in this case, the process does not qualify for log credits. Therefore it needs to be demonstrated that the water abstracted by the bank filtration process is in fact from the river. This can be done by comparing water analyses, or can be confirmed by a hydrogeological survey.

#### Further information

Most of the following discussion has been taken from the LT2ESWTR (USEPA 2003a). Most of the data assessed by the USEPA were from studies of aquifers developed in Dutch North Sea margin sand dune fields and, therefore, represent optimal removal conditions consistent with a homogenous, well sorted (by wind), uniform sand filter, conditions not that common in New Zealand.

Only granular aquifers are eligible for bank filtration credit. Granular aquifers are those comprising sand, clay, silt, rock fragments, pebbles or larger particles and minor cement. The aquifer material is required to be unconsolidated, with subsurface samples friable upon touch.

The aquifer at the well site must be characterised to determine aquifer properties. At a minimum, the aquifer characterisation must include the collection of relatively undisturbed, continuous, core samples from the surface to a depth equal to the bottom of the well screen. The proposed site must have substantial core recovery during drilling operations; specifically, the recovered core length must be at least 90 percent of the total projected depth to the well screen.

Samples of the recovered core must be submitted to a laboratory for sieve analysis to determine grain size distribution over the entire recovered core length. Each sieve sample must be acquired at regular intervals over the length of the recovered core, with one sample representing a composite of each metre of recovered core. Because it is anticipated that wells will range from 15 to 30 metres in depth, a metre sampling interval will result in about 15 to 30 samples for analysis. Each sampled interval must be examined to determine if more than ten percent of the grains in that interval are less than 1.0 mm in diameter.

The length of core with more than 10 percent of the grains less than 1.0 mm in diameter must be summed to determine the overall core length with sufficient fine-grained material so as to provide adequate removal. An aquifer is eligible for removal credit if at least 90 percent of the sampled core length contains sufficient fine-grained material as defined.

*Cryptosporidium* oocysts have a natural affinity for attaching to fine-grained material. The value of 1.0 mm for the bounding size of the sand grains was determined based on calculations performed by Harter using data from Harter et al (2000). Harter showed that for groundwater velocities typical of a bank filtration site (1.5 to 15 m/day), a typical bank filtration site composed of grains with a diameter of 1.0 mm would achieve at least 1.0 log removal over a 50 foot transport distance. Larger-sized grains would achieve less removal, all other factors being equal.

A number of devices are used for the collection of groundwater including horizontal and vertical wells, spring boxes, and infiltration galleries. Among these, only horizontal and vertical wells are eligible for log removal credit.

Horizontal wells are designed to capture large volumes of surface water recharge. They typically are constructed by the excavation of a central vertical caisson with laterals that extend horizontally from the caisson bottom in all directions or only under the riverbed. Groundwater flow to a horizontal well that extends under surface water is predominantly downward. In contrast, groundwater flow to a vertical well adjacent to surface water may be predominantly in the horizontal direction. For horizontal wells, the laterals must be located at least 7.5 m distant from the normal-flow surface water riverbed for 0.5 log removal credit and at least 15 m distant from the normal-flow surface water riverbed for 1.0 log *Cryptosporidium* removal credit. The groundwater flow path to a horizontal well is the measured distance from the bed of the river under normal flow conditions to the closest horizontal well lateral.

A spring box is located at the ground surface and is designed to contain spring outflow and protect it from surface contamination until the water is utilised. Often, localised fracturing or solution-enhanced channels are the cause of the focused discharge to the spring orifice. These fractures and solution channels have significant potential to transport microbial contaminants so that natural filtration may be poor. Thus, spring boxes are not proposed to be eligible for bank filtration credit.

An infiltration gallery is typically a slotted pipe installed horizontally into a trench and backfilled with granular material. The gallery is designed to collect water infiltrating from the surface or to intercept groundwater flowing naturally toward the surface water. The infiltration rate may be manipulated by varying the properties of the backfill or the nature of the soil-water interface. Because the filtration properties of the material overlying an infiltration gallery may be designed or purposefully altered to optimise oocyst removal or for other reasons, this engineered system is not bank filtration, which relies solely on the natural properties of the system. The protozoal log removal requirement for river water drawn from a non-qualifying infiltration gallery can be assessed by sampling for oocysts in the raw water instead of the river. An infiltration gallery designed to the requirements of bankside filtration and performs accordingly, may earn protozoal log credits.

#### 8.4.1.2 Off-river storage

The 2001 draft of LT2ESWTR acknowledged the benefits of off-river raw water storage, when it was intended to give 0.5 log and 1 log presumptive credits for reservoirs with hydraulic detention times of 21 and 60 days, respectively.

The USEPA (2003a) subsequently concluded that the data they assessed illustrated the challenge in reliably estimating the amount of removal that will occur in any particular storage reservoir. Because of this variability and the relatively small amount of available data, they decided it was too difficult to extrapolate from these studies to develop nationally applicable criteria for awarding removal credits to raw water storage.

See section 12.3.2 in Chapter 12: Treatment Processes: Pretreatment for further discussion on off-river storage.

Section 8.2 discusses the *Cryptosporidium* monitoring requirements for determining the protozoal risk categorisation of source waters. The benefit of any *Cryptosporidium* die-off during off-river storage will be acknowledged by sampling the water arriving at the treatment plant. Refer also to Chapter 3 of the review draft LT2ESWTR Toolbox Guidance Manual (USEPA 2009) which discusses issues related to alternative sources and intakes.

#### 8.4.1.3 Presedimentation (only with chemical coagulation)

The USEPA (2003a) proposed in its draft LT2ESWTR to award a presumptive 0.5 log *Cryptosporidium* treatment credit for presedimentation that meets the following three criteria:

- 1 the presedimentation basin must be in continuous operation and must treat all of the flow reaching the treatment plant

- 2 the system must continuously add a coagulant to the presedimentation basin
- 3 the system must demonstrate on a monthly basis at least 0.5 log reduction of influent turbidity through the presedimentation process in at least 11 of the 12 previous consecutive months. This monthly demonstration of turbidity reduction must be based on the arithmetic mean of at least daily turbidity measurements in the presedimentation basin influent and effluent.

Note that in the DWSNZ, the 0.5 log reduction has been equated to 70 percent removal, in order to make the arithmetic easier; see section 8.3 for how to convert percent removal to log reduction.

The criteria were based on an assessment of data relating mean turbidity reduction and the percent of months when mean aerobic spore removal was at least 0.5 log. Data indicate that aerobic spores may serve as a surrogate for *Cryptosporidium* removal by sedimentation, provided optimal chemical dosage conditions apply. Satisfying the criteria appears to provide approximately 90 percent assurance that average spore (and hence oocyst) removal will be 0.5 log or greater.

In most parts of the world, presedimentation is usually no more than a pond that has been dug out between the intake and the plant for the purpose of reducing the gross solids load on the sedimentation tanks. Sometimes alum is dosed crudely into the presedimentation basin to enhance settling. To distinguish between these two types of presedimentation, the DWSNZ discuss the USEPA concept of presedimentation in section 5.4, where it is more commonly termed sedimentation in New Zealand.

Refer to Chapter 12: Treatment Processes, Pretreatment, section 12.3.3 for a discussion on operational and performance aspects of presedimentation. Refer also to Chapter 5 of the review draft LT2ESWTR Toolbox Guidance Manual (USEPA 2009) which discusses issues related to presedimentation.

Section 8.2 discusses the *Cryptosporidium* monitoring requirements for determining the protozoal risk categorisation of source waters. The benefit of any *Cryptosporidium* removal by using presedimentation (with or without coagulation) will be acknowledged by sampling the water arriving at the treatment plant.

#### 8.4.1.4 Watershed control

The LT2ESWTR Final Rule (USEPA 2006) allows a 0.5 log credit for water supplies where an approved 'watershed control programme' has been implemented and carried out. The criteria required for compliance are not particularly quantitative and consequently fairly difficult to apply and assess. In developing the DWSNZ, it was decided that it would be more practicable to incorporate the benefit of any watershed enhancement by monitoring the *Cryptosporidium* oocysts at the raw water intake or as the water reaches the water treatment plant.

Protecting source water quality should be standard water supply practice. Chapter 2 of the *LT2ESWTR Toolbox Guidance Manual Review Draft* (USEPA 2009) discusses aspects related to watershed control in detail; it includes a large, useful list of references.



## 8.4.2 Coagulation processes

### 8.4.2.1 Coagulation, sedimentation, filtration

#### Process description

Sometimes called full or conventional treatment, the coagulation, flocculation, sedimentation and filtration process involves dosage of a chemical, most commonly aluminium sulphate or PAC (polyaluminium chloride), that forms a floc which attracts to it particulate and colloidal matter before separating out in a basin or tank by sedimentation or flotation. Settled water is then passed through rapid gravity (or sometimes pressure) granular (usually sand) filters.

Coagulation and sedimentation without (or prior to) filtration is what the USEPA refers to as presedimentation. See section 8.4.1.3.

Note that sand filtration without chemical coagulation does not remove protozoa from water with any reliability, so does not qualify for protozoal log credits. Some very fine media proprietary filter systems are on the market; they need to be validated and are covered in section 5.17 of the DWSNZ; see section 8.4.5 of these Guidelines.

Operation of the process is discussed in Chapter 13: Treatment Process, Coagulation. Refer also to Chapters 5 and 6 of the review draft LT2ESWTR Toolbox Guidance Manual (USEPA 2009) which discuss issues related to sedimentation and lime softening processes.

#### DWSNZ criteria

- Coagulation, sedimentation without filtration: 0.5 log.
- Coagulation, sedimentation with rapid gravity sand filtration: 3.0 log.

See section 5.4 of the DWSNZ for the protozoal compliance requirements that need to be satisfied in order to qualify for log credits. In the unlikely event that the process is not being operated for the purpose of protozoal compliance, these requirements do not need to be met; theoretically, a water supply could achieve 3 log credits for disinfecting with ozone or UV even if the coagulation, sedimentation and filtration process fails to comply.

The success or failure in satisfying the criteria for this process depends very much on the skill in the collection and testing of samples for turbidity. Turbidity monitoring is discussed in section 8.6.2.1.

Particle counting or particle monitoring can be used instead, but these tests are not easy to perform, see section 8.6.2.2. The DWSNZ do not include a criterion for the size or number of particles. Results tend to be instrument specific, so the performance can be assessed either by the absolute number or the log removal of particles, or a combination. Any water supplier electing to use particle counting or particle monitoring should contact the Ministry of Health for further information.

## Further information

The Southern Milwaukee water treatment plant consistently produced final water with turbidity <0.25 NTU. During the massive *Cryptosporidium* outbreak, daily turbidities were 0.45 NTU or higher, with peaks of 1.7 NTU. They were recycling filter washwater (McKenzie et al 1994).

In its proposed LT2ESWTR, the USEPA (2003a) surveyed studies of the performance of treatment plants in removing *Cryptosporidium*, as well as other micron-sized particles (eg, aerobic spores) that may serve as indicators of *Cryptosporidium* removal. They concluded that these studies supported an estimate of 3 log (99.9 percent) for the average *Cryptosporidium* removal efficiency in conventional water treatment plants. Nearly all of the filter runs evaluated in the survey exhibited spikes where filtered water particle counts increased, and pilot work showed that pathogens are more likely to be released during these spike events.

Full-scale plants in these studies typically demonstrated 2–3 log removal of *Cryptosporidium*, and pilot plants achieved up to almost 6 log removals under optimised conditions. In general, the degree of removal that can be quantified in full-scale plants is limited because *Cryptosporidium* levels following filtration are often below the detection limit of the analytical method. Pilot studies overcome this limitation by seeding high concentrations of oocysts to the plant influent, but extrapolation of the performance of a pilot plant to the routine performance of full-scale plants is uncertain. *Cryptosporidium* removal efficiency in these studies was observed to depend on a number of factors including: water quality, coagulant application, treatment rates and optimisation, filtered water turbidity, and the filtration cycle. The highest removal rates were observed in plants that achieved very low effluent turbidities.

Due to the shortage of data relating to oocysts, the USEPA (2003a) evaluated data provided by water suppliers on the removal of other types of particles, mainly aerobic spores, in the sedimentation processes of full-scale plants. Data indicate that aerobic spores may serve as a surrogate for *Cryptosporidium* removal by sedimentation provided optimal chemical dosage conditions apply (Dugan et al 2001).

Data on the removal of spores (*Bacillus subtilis* and total aerobic spores) during operation of full-scale sedimentation basins were collected independently and reported by three water suppliers. A summary of this spore removal data is shown in Table 8.1.

**Table 8.1: Mean spore removal for full-scale sedimentation basins**

| Water treatment plant       | Mean spore removal  |
|-----------------------------|---|
| St Louis                    | 1.1 log ( <i>B. subtilis</i> )  |
| Kansas City                 | 0.8 log ( <i>B. subtilis</i> )<br>0.46 log ( <i>B. subtilis</i> ) without coagulant |
| Cincinnati (lamella plates) | 0.6 log (total aerobic spores)  |

The USEPA (2003a) analysed the relationship between removal of spores and reduction in turbidity by sedimentation for the three water supplies that provided these data. Results of this analysis are summarised in Table 8.2, which shows the relationship between monthly mean turbidity reduction and the percent of months when mean spore removal was at least 0.5 log.

**Table 8.2: Relationship between mean turbidity reduction during sedimentation and the percent of months when mean spore removal was at least 0.5 log**

| Log reduction in turbidity (monthly mean) | Percent of months with at least 0.5 log mean reduction in spores |
|---|--|
| Up to 0.1                                 | 64%  |
| Up to 0.2                                 | 68%  |
| Up to 0.3                                 | 73%  |
| Up to 0.4                                 | 78%  |
| Up to 0.5                                 | 89%  |
| Up to 0.6                                 | 91%  |
| Up to 0.7                                 | 90%  |
| Up to 0.8                                 | 89%  |
| Up to 0.9                                 | 95%  |
| Up to 1.0                                 | 96%  |

To simplify the arithmetic, the DWSNZ adopted a 70 percent turbidity reduction criterion instead of the 0.5 log, in order for the sedimentation process to qualify for the 0.5 log credit, see section 5.4 of DWSNZ. The 0.5 log credit only applies when the coagulation, sedimentation process is not followed by rapid gravity sand filtration; normally it does, in which case 3 log credits are possible.

When the raw water turbidity is low, most coagulation/sedimentation processes may have some difficulty achieving 70 percent reduction. For example, if the raw water turbidity averages 3 NTU for a few months of the year, the average settled water turbidity would have to be less than 0.9 NTU for those months, which could be difficult for some plants to achieve.

One study (Dugan et al 2001) evaluated the ability of conventional treatment to remove *Cryptosporidium* under varying water quality and treatment conditions, and assessed turbidity, aerobic spores, and total particle counts (TPC) as indicators of *Cryptosporidium* removal. Under optimal coagulation conditions, oocyst removal across the sedimentation basin ranged from 0.6 to 1.8 log, averaging 1.3 log, and removal across the filters ranged from 2.9 to greater than 4.4 log, averaging greater than 3.7 log. Removal of aerobic spores, TPC, and turbidity all correlated with removal of *Cryptosporidium* by sedimentation, and these parameters were conservative indicators of *Cryptosporidium* removal across filtration. Suboptimal coagulation conditions (underdosed relative to jar test predictions) significantly reduced plant performance. Under those conditions, oocyst removal in the sedimentation basin averaged 0.2 log, and removal by filtration averaged 1.5 log.

Harrington et al (2001) studied the removal of *Cryptosporidium* by sedimentation and dissolved air flotation (DAF) using bench scale jar tests and pilot scale conventional treatment trains. In the bench scale experiments, all run at optimised coagulant doses, mean log removal of *Cryptosporidium* was 1.2 by sedimentation and 1.7 by DAF.

Lime softening is a water treatment process that uses precipitation with lime and other chemicals to reduce hardness and enhance clarification prior to filtration. A single-stage softening plant, which is used to remove calcium hardness, includes a primary clarifier and filtration components. The USEPA (2003a) has determined that lime softening plants achieve a level of *Cryptosporidium* removal equivalent to conventional treatment plants (ie, average of 3 log).

## 8.4.2.2 Coagulation, direct filtration

### Process description

This process is similar to full or conventional treatment as described in section 8.4.2.1, except that there is no sedimentation or flotation step. Because all the particulate and colloidal matter is removed by rapid gravity or sometimes pressure sand filters, this process is only appropriate for relatively clean raw waters, particularly if they do not experience sudden changes in quality.

Operation of the process is discussed in Chapter 13: Treatment Process, Coagulation.

### DWSNZ criteria

See section 5.5 of the DWSNZ for the protozoal compliance requirements that need to be satisfied in order to qualify for the 2.5 log credits. In the unlikely event that the process is not being operated for the purpose of protozoal compliance, these requirements do not need to be met; theoretically, a water supply could achieve sufficient log credits for disinfecting with ozone or UV, even if the coagulation and filtration process fails to comply.

Refer to section 8.6.2.1 and 8.6.2.2 for comments about turbidity monitoring and particle counting.

There have been reports of direct filtration plants failing without the operator noticing. This can happen when alum is added to a low turbidity raw water (say 0.35 NTU) at the wrong dose or wrong pH. The filtered water turbidity may be slightly lower than the raw water (say 0.30 NTU) but little floc has formed so the filters are largely ineffective, allowing protozoa (oo)cysts to pass through, while the water appears to comply with the DWSNZ. Plants where this has happened often have raw water with low turbidity but high colour, usually occurring when the water is cold (say <10°C). It may be advisable at plants where this can happen to include residual aluminium or UV absorbance monitoring to help indicate when these circumstances have arisen.

The filter washing process is not continued until the filter is 100 percent clean. As a result, filtrate for several minutes after backwashing can have an elevated turbidity, even if the filter has a slow start mechanism. Modern filter design usually arranges to waste filtered water for the first 10–20 minutes. The turbidity of this water does not need to be monitored for compliance purposes. However, it would be useful to monitor it for operational reasons.

### Further information

The USEPA (2003a) has concluded that the majority of available data support a lower estimate of *Cryptosporidium* removal efficiency for direct filtration plants. Pilot and full-scale studies demonstrate that sedimentation basins, which are absent in direct filtration, can achieve 0.5 log or greater *Cryptosporidium* reduction.

Emelko et al (2000) investigated *Cryptosporidium* removal during vulnerable filtration periods using a pilot scale direct filtration system. The authors evaluated different operational conditions: stable, early breakthrough and late breakthrough. During stable operation, effluent turbidity was approximately 0.04 NTU and *Cryptosporidium* removal ranged from 4.7 to 5.8 log. In the early breakthrough period, effluent turbidity increased from approximately 0.04 to 0.2 NTU, and *Cryptosporidium* removal decreased significantly, averaging 2.1 log. For the late breakthrough period, where effluent turbidity began at approximately 0.25 NTU and ended at 0.35 NTU, *Cryptosporidium* removal dropped to an average of 1.4 log.

## 8.4.2.3 Second stage filtration

### Process description

In the proposed LT2ESWTR, the USEPA (2003a) states that only water treatment plants that include chemical coagulation and rapid sand or dual media filtration, with or without sedimentation, qualify for log credits when using secondary filtration. Secondary filtration (called second stage filtration in the DWSNZ) consists of rapid sand, dual media, granular activated carbon (GAC), or other fine grain media in a separate filtration stage. The USEPA (2003a) considered that secondary filtration log credits were appropriate based on the theoretical consideration that the same mechanisms of pathogen removal will be operative in both a primary and secondary filtration stage. Therefore, shallow bed, coarse media, high rate filtration systems cannot comply. A cap, such as GAC or anthracite, on a single stage of filtration will not qualify for this credit.

The DWSNZ also allow the use of cartridge and membrane filtration when used as secondary filters, provided they also follow chemical coagulation and rapid sand or dual media filtration, with or without sedimentation. The rationale is that these filters are fine enough to trap particles as small as protozoa that pass through the primary filter. It was decided to award these filtration processes 0.5 log credits also. See section 8.3 for further discussion. Secondary filters that are coarser than the primary filters will not noticeably enhance further removal of protozoa.

Operation of the rapid sand or dual media filtration process is discussed in Chapter 13: Treatment Process, Coagulation. Cartridge and membrane filtration are discussed in Chapter 14: Treatment Process, Filtration. Refer also to Chapter 9 of the review draft LT2ESWTR Toolbox Guidance Manual (USEPA 2009) which discusses issues related to second stage filtration.

### DWSNZ criteria

See section 5.6 of the DWSNZ for the protozoal compliance requirements that need to be satisfied in order to qualify for the additional 0.5 log credit. Note that sand or carbon grain size (or their effective sizes and uniformity coefficients), bed depth, and filtration rates are not specified; log credits are awarded on the ability to achieve a specified filtrate turbidity. Refer to sections 8.6.2.1 and 8.6.2.2 for comments about turbidity monitoring and particle counting.

In responding to the draft USEPA LT2ESWTR proposal, all commenters opposed setting regulatory design standards for secondary filters on the basis that water suppliers and states need the flexibility to determine appropriate treatment designs. Consequently, the USEPA did not establish filter design criteria in their final rule (USEPA 2006a), but required that states approve the second-stage filtration design. Similarly, any New Zealand water supplier wishing to qualify for log credits for second-stage filtration will need to have the filter design checked by a DWA.

### Further information

Data on increased removal resulting from a second stage of filtration are limited, and there is uncertainty regarding how effective secondary filtration will be in reducing levels of microbial pathogens that are not removed by the first stage of filtration.

The USEPA (2003a) received data from the City of Cincinnati, Ohio, on the removal of aerobic spores through a conventional treatment plant using GAC contactors for DBP, taste, and odour control after rapid sand filtration. During 1999 and 2000, the mean values of reported spore concentrations in the influent and effluent of the GAC contactors were 35.7 and 6.4 cfu/100 mL respectively, indicating an average removal of 0.75 log across the contactors. Approximately 16 percent of the GAC filtered water results were below detection limit (1 cfu/100 mL) so the actual log spore removal may have been greater than indicated by these results.

## 8.4.2.4 Combined filtration

### Process description

The enhanced combined filtration category is for water treatment plants that practise continuous chemical coagulation, with or without sedimentation. Only rapid granular or dual media filters qualify for log credits when using combined filtration for protozoa removal. The additional 0.5 log credit is awarded for achieving and maintaining a lower turbidity in the combined filtered water than required in section 5.3 of the DWSNZ. Refer also to Chapter 7 of the review draft LT2ESWTR Toolbox Guidance Manual (USEPA 2009) which discusses issues related to combined and individual filter performance.

## DWSNZ criteria

See section 5.7 of the DWSNZ for the protozoal compliance requirements that need to be satisfied in order to qualify for the additional 0.5 log credit. Refer to section 8.6.2.1 for comments about turbidity monitoring and 8.6.2.2 for particle counting.

## Further information

In its proposed LT2ESWTR, the USEPA (2003a) reviewed studies that evaluated the efficiency of granular media filtration in removing *Cryptosporidium* when operating at different effluent turbidity levels.

The USEPA considered that plants attempting to meet a turbidity standard of 0.15 NTU in 95 percent of samples will consistently operate below 0.10 NTU in order to ensure continuous compliance. (This could in effect be their control limit.) Therefore the USEPA compared *Cryptosporidium* removal efficiency when effluent turbidity was 0.10 NTU or less with removal efficiency in the range of 0.11 to 0.20 NTU.

Patania et al (1995) conducted pilot-scale studies at four locations to evaluate the removal of seeded *Cryptosporidium* and *Giardia*, turbidity, and particles. Treatment processes, coagulants, and coagulant doses differed among the four locations. Samples of filter effluent were taken at times of stable operation and filter maturation.

Emelko et al (1999) used a bench scale dual media filter to study *Cryptosporidium* removal during both optimal and challenged operating conditions. Water containing a suspension of kaolinite clay was spiked with oocysts, coagulated in-line with alum, and filtered. Oocyst removal was evaluated during stable operation when effluent turbidity was below 0.10 NTU. Removal was also measured after a hydraulic surge that caused process upset, and with coagulant addition terminated. These later two conditions resulted in effluent turbidities greater than 0.10 NTU and decreased removal of *Cryptosporidium*.

Dugan et al (2001) evaluated *Cryptosporidium* removal in a pilot scale conventional treatment plant. Sixteen filtration runs seeded with *Cryptosporidium* were conducted at different raw water turbidities and coagulation conditions. Eleven of the runs had an effluent turbidity below 0.10 NTU, and five runs had effluent turbidity between 0.10 and 0.20 NTU.

The results from these three studies are summarised in Table 8.3. *Cryptosporidium* removal when the turbidity was 0.10 NTU or lower was markedly better than when in the 0.11–0.20 NTU range (mean improvement 0.85 log, minimum improvement 0.5 log).

**Table 8.3: Studies of *Cryptosporidium* removal at different filtrate turbidity levels**

| Micro-organism         | Log removal found in turbidity range of: |               | Study   |
|------------------------|--|---------------|---------|
|                        | Up to 0.10 NTU                           | 0.11–0.20 NTU |         |
| <i>Cryptosporidium</i> | 4.4                                      | 3.6           | Patania |
| <i>Giardia</i>         | 4.2                                      | 3.2           |         |
| <i>Cryptosporidium</i> | 4.1                                      | 3.6           | Emelko  |
| <i>Cryptosporidium</i> | 3.7                                      | 2.6           | Dugan   |

## 8.4.2.5 Individual filtration

### Process description

The enhanced individual filtration category is for water treatment plants that practise chemical coagulation, with or without sedimentation. Only rapid granular or dual media filters qualify for log credits when using individual filtration for protozoa removal. The additional 1 log credit is awarded for achieving and maintaining a lower turbidity in the water leaving each filter than required in section 5.3 of the DWSNZ. Refer also to Chapter 7 of the review draft LT2ESWTR Toolbox Guidance Manual (USEPA 2009) which discusses issues related to combined and individual filter performance.

### DWSNZ criteria

See section 5.8 of the DWSNZ for the protozoal compliance requirements that need to be satisfied in order to qualify for the additional 1.0 log credit. Refer to section 8.6.2.1 for comments about turbidity monitoring and 8.6.2.2 for particle counting.

One of the criteria that has to be met is that the turbidity of the water leaving any filter does not exceed 0.30 NTU for more than 1 percent of the time, over the compliance period; 1 percent of a 30-day month is a total of 7.2 hours or an average of 14.4 minutes per day. This criterion implies that if filters are washed daily, they will need a run-to-waste facility to avoid the period when filters traditionally produce their dirtiest water.

### Further information

Refer to the discussion in the Combined Filtration section above.

In its proposed LT2ESWTR the USEPA (2003a) considered that modestly elevated turbidity from a single filter may not significantly impact combined filter effluent turbidity levels, but may indicate a substantial reduction in the overall pathogen removal efficiency of the filtration process. Consequently, water supplies that continually achieve very low turbidity in each individual filter are likely to provide a significantly more effective microbial barrier. The USEPA expects that supplies that select this toolbox option will have achieved a high level of treatment process optimisation and process control, and will have both a history of consistent performance over a range of raw water quality conditions and the capability and resources to maintain this performance long-term.

## 8.4.3 Filtration processes

The following subsections discuss diatomaceous earth, slow sand, bag, cartridge and membrane filtration.

Filtration processes such as roughing filters and microstrainers are not discussed in this chapter because they do not earn log credits for the removal of protozoa. Refer to Chapter 12: Pretreatment Processes. Sand filters used without chemical coagulation do not earn protozoal log credits.



It is possible to demonstrate that other filtration processes can achieve satisfactory removal of protozoa. Section 5.17 of the DWSNZ covers the requirements for new treatment processes, written mainly for larger processes. Section 8.4.3.4 details the procedure to be followed to show whether a cartridge filter meets the requirements of the DWSNZ. This procedure allows for challenge testing to meet acceptable international standards, such as AS/NZS 4348:1995 in conjunction with AS/NZS 3497:1998 (updated 2001)). The MoH may accept use of this approach for treatment processes other than cartridge filters.

### 8.4.3.1 Diatomaceous earth

#### Process description

Diatomaceous earth filtration is a process in which a precoat cake of filter medium is deposited on a support membrane and additional diatomaceous earth (DE) is usually added continuously to the feed water to maintain the permeability of the filter cake. The process can operate under vacuum or pressure. Normally there is no upstream coagulation process, so to avoid uneconomically short filter runs, the process is limited to fairly consistently clean raw waters, ie, fairly low turbidity and low colour.

Operation of the process is discussed in Chapter 14: Treatment Process, Filtration.

#### DWSNZ criteria

See section 5.9 of the DWSNZ for the protozoal compliance requirements that need to be satisfied in order to qualify for the 2.5 log credits. In the unlikely event that the process is not being operated for the purpose of protozoal compliance, these requirements do not need to be met; theoretically, a water supply could achieve sufficient log credits for disinfecting with ozone or UV, even if the filtration process fails to comply.

One of the requirements is that the minimum DE precoat thickness that is needed before protozoa are removed reliably in different raw water conditions is to be determined by turbidity testing. This will involve (where applicable) testing a range of raw water conditions such as after rain, during droughts, warm and cold water, and when algae are near their maximum numbers. The tests should also include a period of maximum flow conditions at different precoat loading rates. While this is happening the water leaving the filters should be run to waste or returned to the raw water. The results of these trials should be documented.

The DWSNZ also include a clause that exempts some water supplies from meeting various turbidity requirements. This was added for the very small number of water supplies that have fine colloidal silica, sometimes called glacial flour, in their raw water. This material is a fraction of the size of (oo)cysts and most will pass through the filters. Therefore turbidity stops being a reliable measure of the filter's ability to remove (oo)cysts. It is possible in the future that the MoH will conduct a survey of these plants, using particle counters.

Section 5.9.1, note 1, states: "All water passes through the process, which is continuous while producing filtrate". Restarting the plant after a shutdown can dislodge the material built up on the septum, so on/off operation should be avoided, or the filtrate should be recycled until the turbidity is satisfactory.

Particles trapped in the filter are held rather tenuously, so whenever the filtrate turbidity exceeds the influent turbidity, the very real risk of a discharge of oocysts must be accepted, and handled appropriately.

### Further information

The USEPA (2003a) considered that a study of DE filtration by Ongerth and Hutton (2001) supported the findings of earlier studies in showing that a well-designed and operated DE plant can achieve *Cryptosporidium* removal equivalent to a conventional treatment plant (ie, average of 3 log). In developing the DWSNZ it was considered DE filtration was more like the coagulation, direct filtration process than a full scale conventional treatment plant because neither include the sedimentation stage, which has been shown to achieve 0.5 log or greater *Cryptosporidium* reduction.

## 8.4.3.2 Slow sand filtration

### Process description

Slow sand filtration is a process involving passage of raw water through a bed of sand at low velocity, generally less than 0.4 m/h (which compares with say 20 m/h in rapid granular media filtration) resulting in substantial particulate removal by physical and biological mechanisms. Removal of microbial pathogens in slow sand filters is complex and is believed to occur through a combination of physical, chemical, and biological mechanisms, both on the surface (schmutzdecke) and in the interior of the filter bed.

Operation of the process is discussed in Chapter 14: Treatment Process, Filtration.

### DWSNZ criteria

See section 5.10 of the DWSNZ for the protozoal compliance requirements that need to be satisfied in order to qualify for the 2.5 log credits. In the unlikely event that the process is not being operated for the purpose of protozoal compliance, these requirements do not need to be met; theoretically, a water supply could achieve sufficient log credits for disinfecting with ozone or UV, even if the filtration process fails to comply.

Particles trapped on the sand grains are held rather tenuously, so whenever the filtrate turbidity exceeds the influent turbidity, the very real risk of a discharge of oocysts must be accepted, and handled appropriately.

## Further information

Hall et al (1994) examined the removal of *Cryptosporidium* with a pilot scale slow sand filtration plant. *Cryptosporidium* removals ranged from 2.8 to 4.3 log after filter maturation, with an average of 3.8 log (at least one week after filter scraping). Raw water turbidity ranged from 3.0–7.5 NTU for three of four runs and 15.0 NTU for a fourth run. Filtered water turbidity was 0.2–0.4 NTU, except for the fourth run which was 2.5 NTU.

Fogel et al (1993) evaluated removal efficiencies for *Cryptosporidium* and *Giardia* with a full-scale slow sand filtration plant. The removals ranged from 0.1–0.5 log for *Cryptosporidium* and 0.9–1.4 log for *Giardia*. Raw water turbidity ranged from 1.3–1.6 NTU and decreased to 0.35 NTU after filtration. The authors attributed the low *Cryptosporidium* and *Giardia* removals to the relatively poor grade of filter media and lower water temperature. The sand had a higher uniformity coefficient than recommended by design standards. This creates larger pore spaces within the filter bed that retard biological removal capacity. Lower water temperatures (1°C) also decreased biological activity in the filter media.

The study by Fogel et al is significant because it indicates that a slow sand filtration plant may achieve less than 2 log removal of *Cryptosporidium* removal while still being in compliance with filtrate turbidity requirements. This is why the compliance criteria in the DWSNZ include water temperature monitoring with a lower limit of 6°C.

### 8.4.3.3 Bag filtration

#### Process description

The USEPA (2003a) defined bag filters as pressure driven separation processes that remove particulate matter larger than 1 micrometre using an engineered porous filtration medium through either surface or depth filtration.

Bag filters are typically constructed of a non-rigid, fabric filtration media housed in a pressure vessel in which the direction of flow is from the inside of the bag to the outside.

Operation of the process is discussed in Chapter 14: Treatment Process, Filtration. The testing protocol for the verification of equipment performance is described in EPA/NSF ETV (2005). See USEPA (2012a) for an update. Refer also to Chapter 8 of the review draft LT2ESWTR Toolbox Guidance Manual (USEPA 2009) which discusses issues related to bag and cartridge filtration.

#### DWSNZ criteria

See section 5.13 of the DWSNZ for the protozoal compliance requirements that need to be satisfied in order to qualify for the 1 log credit. In the unlikely event that the process is not being operated for the purpose of protozoal compliance, these requirements do not need to be met; theoretically, a water supply could achieve sufficient log credits for disinfecting with ozone or UV, even if the filtration process fails to comply.

To obtain 1 log credit, bag filters must be validated to achieve 2 log removals of *Cryptosporidium*. This factor of safety, which has been adopted from the USEPA (2003a, 2006a), is applied to the removal credit because:

- the removal efficiency of bag filters over the course of a filter run has been observed to vary by more than 1 log
- bag filters are not routinely direct integrity tested during operation, so there is no means of verifying the removal efficiency of filtration units during routine use.

Validated bags can also earn 0.5 log credits if used (but highly unlikely) as secondary filters after a coagulation process, and 0.5 log credits when used as secondary filters after diatomaceous earth or slow sand filters, also unlikely (see Table 5.2 DWSNZ).

The DWSNZ also include a clause that exempts some water supplies from meeting various turbidity requirements. This was added for the very small number of water supplies that have fine colloidal silica, sometimes called glacial flour, in their raw water. This material is a fraction of the size of (oo)cysts and most will pass through the filters. Therefore turbidity stops being a reliable measure of the filter's ability to remove (oo)cysts. It is possible in the future that the MoH will conduct a survey of these plants, using particle counters.

Particles trapped in the bag are held rather tenuously, so whenever the filtrate turbidity exceeds the influent turbidity, the very real risk of a discharge of oocysts must be accepted, and handled appropriately. Restarting the plant after a shutdown can dislodge the material built up on the filter, so on/off operation should be avoided, or the filtrate should be recycled until the turbidity is satisfactory.

An investigation is required, if in any day, the pressure drop across the bag filter increases by more than 5 percent of the total allowable. Also, if the pressure differential does not increase over a reasonable time span, consideration must be given to the possibility that the water is short-circuiting via faulty seals etc. Refer to Chapter 14: Treatment Processes: Filtration, section 14.5 for further information.

### Performance validation/certification

Manufacturers commonly rate fabric filters by pore size or pore distribution. However, there is no industry standard for measuring or reporting these characteristics. This lack of standardisation causes problems for establishing design criteria to ensure that a given bag filter will effectively remove a given percentage of *Cryptosporidium*. Furthermore, an oocyst has different structural characteristics than the markers used to determine pore size; thus, the rate of rejection may differ for an oocyst versus the test markers used to determine pore size or molecular weight cut-off. To compensate for these factors of uncertainty for *Cryptosporidium* removal, the LT2ESWTR requires bag filters to be challenge tested to determine removal credit.

The log removal validation is based on challenge testing. The equipment supplier or manufacturer must perform challenge tests before the water supplier purchases the plant. Certificates of performance are to be supplied. The Medical Officer of Health may also require challenge tests to check that a treatment (or other) problem has been rectified. Challenge testing must be conducted on a full-scale filter element identical in material and construction to the filter elements proposed for use in full-scale treatment facilities.

Water suppliers may adopt the equipment or appliance supplier’s certification provided:

- a) it meets one of the following:
  - the *Membrane Filtration Guidance Manual* (USEPA 2005), which contains detailed guidance on developing challenge test protocol and conducting the test for membrane processes that relate to these requirements
  - the *Protocol for Equipment Verification Testing for Physical Removal of Microbiological and Particulate Contaminants* (NSF 2005), which has a chapter for testing bag and cartridge filters (Chapter 4). See USEPA (2012a) for an update
  - a standard formally recognised by the Ministry of Health as being equivalent
- b) an appropriately accredited inspection body performs the testing
- c) the tests are made on entire units, including filtration media, seals, filter housing and other components integral to the process
- d) the installed equipment is identical (or validated as equivalent) to the equipment tested during the certification process.

### Further information

A limited amount of published data is available regarding the removal efficiency of bag filters with respect to *Cryptosporidium* oocysts or suitable surrogates. The relevant studies identified by the USEPA (2003a) in the literature are summarised in Table 8.4.

**Table 8.4: Results from studies of *Cryptosporidium* (or surrogate) removal by bag filters**

| Organism/surrogate     | Log removal | Study                          |
|------------------------|-------------|--------------------------------|
| <i>Cryptosporidium</i> | 3.0         | Cornwell and Le Chevalier 2002 |
| <i>Cryptosporidium</i> | 0.5 to 3.6  | Li et al 1997                  |
| 4.5 micron spheres     | 0.5 to 2.0  | Goodrich et al 1995            |

These data demonstrate highly variable removal performance, ranging from 0.5 log to 3.6 log.

Li et al (1997) evaluated three bag filters with similar pore size ratings and observed a 3 log difference in *Cryptosporidium* oocyst removal among them. These results indicate that bag filters may be capable of achieving removal of oocysts in excess of 3 log, but performance can vary significantly among products, and there appears to be no correlation between pore size rating and removal efficiency.

Based on available data, specific design criteria that correlate with removal efficiency cannot be derived for bag filters. The removal efficiency of these proprietary devices can be impacted by product variability, increasing pressure drop over the filtration cycle, flow rate, and other operating conditions.

The removal efficiency of some bag filtration devices has been shown to decrease over the course of a filtration cycle due to the accumulation of solids and resulting increase in pressure drop. As an example, Li et al (1997) observed that the removal of 4.5 micrometre microspheres by a bag filter decreased from 3.4 log to 1.3 log over the course of a filtration cycle.

The data in Table 8.4 were generated from studies performed under a variety of operating conditions, many of which could not be considered conservative (or worst-case) operation. These considerations led to the challenge testing requirements which are intended to establish a product specific removal efficiency rather than site-specific.

Only a few bag filtration studies have attempted to correlate turbidity removal with removal of *Cryptosporidium* oocysts or surrogates. Li et al (1997) found that the removal efficiency for turbidity was consistently lower than the removal efficiency for oocysts or microspheres for the three bag filters evaluated. None of the filters was capable of consistently producing a filtered water turbidity below 0.3 NTU for the waters evaluated.

#### 8.4.3.4 Cartridge filtration

##### Process description

The USEPA (2003a) defined cartridge filters as pressure driven separation processes that remove particulate matter larger than 1 micrometer using an engineered porous filtration medium through either surface or depth filtration.

Cartridge filters are typically constructed as rigid or semi-rigid, self-supporting filter elements housed in pressure vessels in which flow is from the outside of the cartridge to the inside.

Although all filters classified as cartridge filters share similarities with respect to their construction, there are significant differences among the various commercial devices. An important distinction is the ability to directly test the integrity of the filtration system in order to verify that there are no leaks that could result in contamination of the filtrate. Any membrane cartridge filtration device that can be direct integrity tested according to the criteria specified in the membrane filtration section of DWSNZ (section 5.11) is eligible for protozoal removal credit as a membrane, subject to the criteria specified in that section.

Operation of the process is discussed in Chapter 14: Treatment Process, Filtration. The testing protocol for the verification of equipment performance is described in EPA/NSF ETV (2005). See USEPA (2012a) for an update. Refer also to Chapter 8 of the LT2ESWTR Toolbox Guidance Manual review draft (USEPA 2009) which discusses issues related to bag and cartridge filtration.

## DWSNZ criteria

See section 5.12 of the DWSNZ for the protozoal compliance requirements that need to be satisfied in order to qualify for the 2 log credits. In the unlikely event that the process is not being operated for the purpose of protozoal compliance, these requirements do not need to be met; theoretically, most water supplies could achieve sufficient log credits for disinfecting with ozone or UV, even if the filtration process fails to comply.

To obtain 2 log credits, cartridges must be validated to achieve 3 log removals (cyst reduction) of *Cryptosporidium*. This 1 log factor of safety is applied to the removal credit for cartridge filters because:

- the removal efficiency of some cartridge filters has been observed to vary by more than 1 log over the course of operation
- cartridge filters are not routinely subjected to direct integrity testing during operation, so there is no means of verifying the removal efficiency of filtration units during routine use.

Qualifying for 2 log credits means that cartridge filtration may be a particularly suitable process for use on a non-secure bore water supply. This can then be followed by chlorination in order to achieve bacterial compliance, and to protect the distribution system.

Validated cartridge filters can also earn 0.5 log credits if used (but highly unlikely) as secondary filters after a coagulation process, and 0.5 log credits when used as secondary filters after diatomaceous earth or slow sand filters, also unlikely (see Table 5.2 DWSNZ).

The DWSNZ also include a clause that exempts some water supplies from meeting various turbidity requirements. This was added for the very small number of water supplies that have fine colloidal silica, sometimes called glacial flour, in their raw water. This material is a fraction of the size of (oo)cysts and most will pass through the filters. Therefore turbidity stops being a reliable measure of the filter's ability to remove (oo)cysts. It is possible in the future that the MoH will conduct a survey of these plants, using particle counters.

Particles trapped in the cartridge are held rather tenuously, so whenever the filtrate turbidity exceeds the influent turbidity, the very real risk of a discharge of oocysts having occurred must be accepted, and handled appropriately. Restarting the plant after a shutdown can dislodge the material built up on the filter, so on/off operation should be avoided, or the filtrate should be recycled until the turbidity is satisfactory.

An investigation is required, if in any day, the pressure drop across the cartridge filter increases by more than 5 percent of the total allowable. Also, if the pressure differential does not increase over a reasonable time, consideration must be given to the possibility that the water is short-circuiting via faulty seals etc. Refer to Chapter 14: Treatment Processes: Filtration, section 14.5 for further information.

See section 8.4.2.3 for a discussion relating to the use of cartridge filtration when used as secondary filters.



## Performance validation/certification

Manufacturers commonly rate fabric filters by pore size or pore distribution, usually 'defined' as being absolute or nominal. However, there is no industry standard for measuring or reporting these characteristics. This lack of standardisation causes problems for establishing design criteria to ensure that a given cartridge filter will effectively remove a given percentage of *Cryptosporidium*. Furthermore, an oocyst has different structural characteristics than the markers used to determine pore size; thus, the rate of rejection may differ for an oocyst versus the test markers used to determine pore size or molecular weight cut-off. To compensate for these factors of uncertainty for *Cryptosporidium* removal, the LT2ESWTR requires cartridge filters to be challenge tested to determine removal credit, see section 8.5.

The log removal validation is based on challenge testing. The equipment supplier or manufacturer must perform challenge tests before the water supplier purchases the plant. Certificates of performance are to be supplied. The Ministry of Health may also require challenge tests to check that a treatment (or other) problem has been rectified. Challenge testing must be conducted on a full-scale filter element identical in material and construction to the filter elements proposed for use in full-scale treatment facilities – **except** see d) and e) below.

Water suppliers may adopt the equipment or appliance supplier's certification provided:

- a) it meets one of the following:
  - the *Membrane Filtration Guidance Manual* (USEPA 2005), which contains detailed guidance on developing challenge test protocol and conducting the test for membrane processes that relate to these requirements
  - the USEPA (2010) *Long Term 2 Enhanced Surface Water Treatment Rule: Toolbox Guidance Manual Part 8: Bag and Cartridge Filters*
  - the (oo)cyst reduction conditions of *Drinking Water Treatment Units: Health effects*, NSF/ANSI 53 (NSF and ANSI 2002a, and subsequent revisions)
  - the Ministry of Health is currently assessing the of suitability of ANSI/NSF 419 2015
  - a standard formally recognised by the Ministry of Health as being equivalent (eg, AS/NZS 4348:1995 in conjunction with AS/NZS 3497:1998 (updated 2001)). If a whole cartridge cannot be tested, the portion submitted for testing must be of sufficient size to allow accurate testing and scalability. The calculation that derived the factor used to relate the flow through the test portion and the complete cartridge must be provided, and will be peer reviewed.
- b) an appropriately accredited inspection body has performed the testing
- c) the installed equipment is identical (or validated as equivalent) to the equipment tested during the certification process
- d) the tests are made on entire units, including filtration media, seals, filter housing and other components integral to the process; **this USEPA requirement is usually impracticable for larger units, so see e)**



- e) a certificated cartridge filter can easily fail due to its assembly, ie, 'its seals and other components integral to the process'. Using a cartridge that satisfies the challenge test requirements is acceptable if:
- the cartridge is single-open-ended (SOE), plug-in style, sealed in the housing with o-rings
  - scaling up to multiple cartridges, the field cartridge is the same diameter and construction as the test cartridge and the cartridge is of uniform construction over its entire length with no joins or joiners; heat-bonded joins are suitable
  - an automatic air release valve sized and rated for the assembly is installed on the top of the filter housing to release any trapped air
  - a default maximum headloss of 150 kPa is set unless the manufacturer can demonstrate that performance is maintained beyond that. Cartridges must be replaced before the terminal pressure drop is reached
  - new/replacement cartridges and plants that operate an on/off regime are run to waste for the first five minutes they come online
  - all components are made from materials approved for use in water supply, eg, ANSI/NSF Standard 61 or equivalent.

As a result of the above clarification, use of the following template is required.

**Template for assessing cartridge filter compliance**

5.12.1 Log credit assessment of – ..... cartridge filter

To obtain 2.0 protozoa log credits for cartridge filtration, the following requirements must be met during periods when the filtered water is being produced.

| DWSNZ requirement   | Status                                  |
|---|---|
| <p>Requirement 1: Each cartridge has a certified <i>Cryptosporidium</i> or cyst removal efficiency of at least 3 log. Water suppliers may adopt the supplier's certification provided:</p> <p>a) it meets one of the following:</p> <ul style="list-style-type: none"> <li>i) the <i>Membrane Filtration Guidance Manual</i> (USEPA 2005), which contains detailed guidance on developing challenge test protocol and conducting the test for membrane processes that relate to these requirements</li> <li>ii) the (oo)cyst reduction conditions of <i>Drinking Water Treatment Units: Health effects</i>, NSF/ANSI 53 (NSF and ANSI 2002a, and subsequent revisions)</li> </ul> <p>or</p> <p>a standard formally recognised by the Ministry of Health as being equivalent, eg, AS/NZS 4348:1995 in conjunction with AS/NZS 3497:1998 (updated 2001).</p> <p>b) an appropriately accredited inspection body has performed the testing</p> <p>c) the installed equipment is identical (or validated as equivalent) to the equipment tested during the certification process</p> <p>d) the tests are made on entire units, including filtration media, seals, filter housing and other components integral to the process. Because this is usually impracticable for larger units, see e)</p> <p>e) a certificated cartridge filter can fail due to its operation or its assembly, ie, "its seals and other components integral to the process". Using a cartridge that satisfies the challenge test requirements is acceptable if:</p> <ul style="list-style-type: none"> <li>• the cartridge is single-open-ended (SOE), plug-in style, sealed in the housing with o-rings</li> <li>• scaling up to multiple cartridges, the field cartridge is the same diameter and construction as the test cartridge and the cartridge is of uniform construction over its entire length with no joins or joiners; heat-bonded joins are suitable</li> <li>• an automatic air release valve is installed on the top of the filter housing to release any trapped air</li> <li>• a default maximum headloss of 150 kPa is set unless the manufacturer can demonstrate that performance is maintained beyond that. Cartridges must be replaced before the terminal pressure drop is reached</li> <li>• new/replacement cartridges and plants that operate an on/off regime are run to waste for at least the first 5 minutes they come online</li> <li>• all components are made from materials approved for use in water supply, eg, ANSI/NSF Standard 61 or equivalent.</li> </ul> | No. Used the alternative e), as follows |
| Requirements 2, 3, and 4 relate to filtrate monitoring  |   |
| Requirement 5 is covered in 1c)   | NA                                      |
| Requirement 6: A slow opening/closing valve is fitted ahead of the cartridge filter plant, and the filtrate passes either through a pressure surge valve or directly to a tank before any subsequent process or pumping.  |   |
| Requirement 7: The flow through each housing is measured. A restrictor that maintains the flow below the certified maximum operating rate is fitted to each housing.  |   |
| Requirement 8: Differential pressure measurements across the housing are recorded to confirm that the minimum differential pressure always exceeds the differential pressure corresponding to a clean filter established during commissioning, and are kept within the manufacturer's recommendations.  |   |

## Further information

A limited amount of published data is available regarding the removal efficiency of cartridge filters with respect to *Cryptosporidium* oocysts or suitable surrogates. The relevant studies identified by the USEPA (2003a) in the literature are summarised in Table 8.5.

**Table 8.5: Results from studies of *Cryptosporidium* (or surrogate) removal by cartridge filters**

| Organism/surrogate     | Log removal | Study               |
|------------------------|-------------|---------------------|
| <i>Cryptosporidium</i> | 3.5 average | Enriques et al 1999 |
| <i>Cryptosporidium</i> | 3.3 average | Roessler 1998       |
| <i>Cryptosporidium</i> | 1.1 to 3.3  | Schaub et al 1993   |
| 5.7 micron spheres     | 0.5 to 3.6  | Long 1983           |

These data demonstrated highly variable removal performance, ranging from 0.5 log to 3.6 log.

Results of these studies also show no correlation between the pore size rating established by the manufacturer and the removal efficiency of a filtration device. In a study evaluating two cartridge filters, both with a pore size rating of 3 micrometres, a 2 log difference in *Cryptosporidium* oocyst removal was observed between the two filters (Schaub et al 1993).

Another study evaluated 17 cartridge filters with a range of pore size ratings from 1 to 10 micrometres and found no correlation with removal efficiency (Long 1983). It has been noted that although *Cryptosporidium* is 4 to 6 microns in size, it can still pass through an absolute 3-micron size filter by deforming and squeezing through (USEPA 2003b).

Based on available data, specific design criteria that correlate to removal efficiency cannot be derived for cartridge filters. The removal efficiency of these proprietary devices can be impacted by product variability, increasing pressure drop over the filtration cycle, flow rate, and other operating conditions. The data in Table 8.5 were generated from studies performed under a variety of operating conditions, many of which could not be considered conservative (or worst-case) operation. These considerations led to the challenge testing requirements which are intended to establish a product specific removal efficiency, rather than site-specific.

### 8.4.3.5 Membrane filtration

#### Process description

In their proposed LT2ESWTR, the USEPA (2003a) defined membrane filtration as a pressure or vacuum driven separation process in which particulate matter larger than 1 µm (micrometre) is rejected by a nonfibrous, engineered barrier, primarily through a size exclusion mechanism, and which has a measurable removal efficiency of a target organism that can be verified through the application of a direct integrity test.

This definition is intended to include the common membrane classifications: microfiltration (MF), ultrafiltration (UF), nanofiltration (NF), and reverse osmosis (RO). MF and UF are relatively low pressure membrane filtration processes that are primarily used to remove particulate matter and microbial contaminants. NF and RO are membrane separation processes that are primarily used to remove dissolved contaminants through a variety of mechanisms, but which also remove particulate matter via a size exclusion mechanism. MF and UF are the more common larger processes. The others tend to be used for individual supplies (eg, point-of-use) or for special purposes.

MF membranes are generally considered to have a pore size range of 0.1–0.2 microns or micrometres (nominally 0.1 microns), although there are exceptions. For UF, pore sizes generally range from 0.01–0.05 microns (nominally 0.01 microns) or less, decreasing to an extent at which the concept of a discernible ‘pore’ becomes inappropriate, a point at which some discrete macromolecules can be retained by the membrane material. In terms of a pore size, the lower cut-off for a UF membrane is approximately 0.005 µm. Because some UF membranes have the ability to retain larger organic macromolecules, they have been characterised historically by a molecular weight cut-off (MWCO) rather than by a particular pore size. Typical MWCO levels for UF membranes range from 10,000 to 500,000 Daltons, with most membranes used for water treatment at approximately 100,000 MWCO.

The critical distinction between membrane filtration processes and bag and cartridge filters is that the integrity of membrane filtration processes can be tested directly. Based on this distinction, membrane material configured into a cartridge filtration device that meets the definition of membrane filtration and that can be direct integrity tested according to the criteria specified in this section is eligible for the same removal credit as a membrane filtration process.

Membrane devices can be designed in a variety of configurations including hollow-fibre modules, hollow-fibre cassettes, spiral-wound elements, cartridge filter elements, plate and frame modules, and tubular modules among others.

The generic term module is used to refer to all of these various configurations and is defined as the smallest component of a membrane unit in which a specific membrane surface area is housed in a device with a filtrate outlet structure. A membrane unit is defined as a group of membrane modules that share common valving that allows the unit to be isolated from the rest of the system for the purpose of integrity testing or other maintenance.

Operation of the process is discussed in Chapter 14: Treatment Process, Filtration. Refer also to Chapter 14 of the review draft LT2ESWTR Toolbox Guidance Manual (USEPA 2009) which discusses issues related to membrane filtration.

### DWSNZ criteria

It is possible to earn 3 or more log credits by using membrane filtration as the sole treatment process. Membrane filtration can also earn its full number of log credits when used in place of rapid gravity sand filters in a chemical coagulation plant. See section 8.4.2.3 for a discussion relating to the use of membrane filters used as secondary filters.

Because membrane filters have a pore size range of 0.1–0.2 microns or smaller, other filtration systems used in a secondary role are not likely to remove the particles that pass through the membrane filter, so they cannot earn secondary filtration log credits.

See section 5.11 of the DWSNZ for the protozoal compliance requirements that need to be satisfied in order to qualify for log credits. In the unlikely event that the process is not being operated for the purpose of protozoal compliance, these requirements do not need to be met; theoretically, a water supply could achieve 3 log credits for disinfecting with ozone or UV, even if the filtration process fails to comply.

In systems that operate on/off, the filtrate is recycled or wasted until the approved upper control limits of the indirect integrity monitoring (eg, turbidity or particle counting) are no longer exceeded. If air routinely affects the online measurement of turbidity and/or particle counting on restart, and it has been demonstrated that the turbidity and/or particle count on restart is falsely indicating inadequate performance of the membranes, then on return to service the turbidity must be less than 0.10 NTU or the particle count below the upper control limit within 15 minutes. If this is not achieved the filtrate must be recycled or wasted until this level of performance has been achieved.

### Performance validation/certification

The Membrane Filtration Guidance Manual (proposal: USEPA 2003c, and final rule: USEPA 2005a) sets out a procedure for challenge testing, see section 8.5 of these Guidelines. The requirement for challenge testing is intended to be product-specific such that site-specific demonstration of *Cryptosporidium* removal efficiency is not necessary. Once the log removal of a membrane has been established through a challenge test that meets the requirements of LT2ESWTR, additional challenge testing is not required unless significant modifications are made to the membrane process.

The maximum number of protozoal log credits that a membrane filtration process is eligible to receive depends upon the manufacturer's certification of the log removal that the filter plant can deliver, see section 5.11.1 of the DWSNZ. So far, all MF plants in New Zealand have been assigned 4 log credits. Although some models have validation for up to 7 log removals, these results have usually been achieved under short term trial conditions, rather than continuously running with variable raw water quality and operating conditions.

The testing protocol for the verification of equipment performance is described in a 246-page publication of EPA/NSF ETV (2002), and in the Membrane Filtration Guidance Manual (USEPA 2005a).

### Procedure for older plants

Data from challenge studies conducted prior to promulgation of the DWSNZ 2005 can be considered in lieu of additional testing. However, the prior testing must have been conducted in a manner that demonstrates removal efficiency for *Cryptosporidium* greater than the treatment credit awarded to the process.

The Membrane Filtration Guidance Manual (USEPA 2005a) states in section 3.15 that as a general guide, the following challenge test conditions have been identified as potentially yielding results that do not satisfy the intent of the rule:

- challenge testing conducted on obsolete products. Refer to section 3.14 for guidance on the re-testing of modified membrane modules
- challenge testing conducted on small-scale modules. Small-scale module testing is permitted under the LT2ESWTR if certain criteria are met. Refer to section 3.8 for guidance regarding the testing of small-scale modules

- challenge testing using unacceptable surrogates for *Cryptosporidium*. The challenge particulate used in a grandfathered test must provide equivalent or sufficiently conservative removal efficiency relative to *Cryptosporidium* oocysts. Refer to section 3.9 regarding the selection of surrogates for use in challenge testing
- challenge particulate enumeration using unacceptable methodology. The challenge particulate must have been quantified using an acceptable method. Specifically, gross measurements are generally considered unacceptable. Refer to section 3.9 regarding methods for enumerating various challenge particulates
- unavailable quality control release value (QCRV). If non-destructive performance testing was not used to establish a suitable QCRV in a previous study, it may be difficult or impossible to relate the demonstrated removal efficiency to the non-destructive performance test results for untested modules that are produced.

Section 3.15 of the Membrane Filtration Guidance Manual adds that there may also be cases in which deviations from challenge testing requirements under the LT2ESWTR may not be significant, such that additional testing would not be required.

### Further information

A number of studies have been conducted which have demonstrated the ability of membrane filtration processes to remove pathogens, including *Cryptosporidium*, to below detection levels. A literature review summarising the results of several comprehensive studies was conducted and reported by the USEPA (2001a) and is presented in Low Pressure Membrane Filtration for Pathogen Removal: Application, Implementation, and Regulatory Issues.

Many of these studies used *Cryptosporidium* seeding to demonstrate removal efficiencies as high as 7 log. The collective results from these studies demonstrate that an integral membrane module, ie, a membrane module without any leaks or defects, with an exclusion characteristic smaller than *Cryptosporidium*, is capable of removing this pathogen to below detection in the filtrate, independent of the feed concentration.

Although it is not uncommon for a membrane plant (MF and UF) to demonstrate up to 6 or more protozoal log credits in the challenge test, most are assigned 4 log credits by the US regulatory bodies. Therefore to be assigned other than 4 log credits would require unusual circumstances. The most likely reason for going under 4 would probably be due to the use of a direct integrity test (DIT) of lower resolution and sensitivity than those commonly used today. Maybe more than 4 log credits could be assigned to NF or RO plants, but so far their use in New Zealand has been limited to very small supplies. In the very improbable event of a New Zealand source water being of such poor quality that it is categorised as needing more than 4 protozoal log credits, the multiple barrier principle would suggest that a membrane plant on its own would offer insufficient confidence about the final product being safe to drink.

## 8.4.4 Disinfection processes

### 8.4.4.1 Chlorine dioxide

#### Process description

The disinfectant chlorine dioxide ( $\text{ClO}_2$ ) is made on site and can be dosed into the water supply to inactivate micro-organisms, including bacteria, viruses, and protozoa such as *Cryptosporidium*.

Operation of the chlorine dioxide disinfection process is discussed in section 15.5.3 of Chapter 15: Treatment Process, Disinfection; C.t values are discussed in section 15.2.1; contact tanks and hydraulic residence time (t) are discussed in section 15.2.9. Refer also to Chapter 10 of the review draft LT2ESWTR Toolbox Guidance Manual (USEPA 2009) which discusses issues related to disinfection using chlorine dioxide.

#### DWSNZ criteria

See section 5.14 of the DWSNZ for the protozoal compliance requirements that need to be satisfied in order to qualify for log credits. In the unlikely event that the process is not being operated for the purpose of protozoal compliance, these requirements do not need to be met; theoretically, a water supply could achieve 3 log credits for disinfecting with ozone or UV, or could earn 3 log credits using chemical coagulation, sedimentation, filtration, or membrane filtration, even if the chlorine dioxide process is non-complying.

The chlorite ion ( $\text{ClO}_2^-$ ) is the predominant by-product when chlorine dioxide is used as a disinfectant. About 50–70 percent of the chlorine dioxide dosed into the water may be converted to chlorite. On this basis, the maximum dose that can be used without chlorite exceeding its 0.8 mg/L MAV is about 1.2–1.6 mg/L. As a result, impractically long contact times may be needed to achieve protozoal compliance. Pilot trials to determine the chlorite levels that will form should be undertaken.

#### Further information

The C.t table in the DWSNZ for protozoal compliance using chlorine dioxide was taken from Table IV.D–4 in the LT2ESWTR (USEPA 2006a). It was based on Clark et al (2003) who employed data from Li et al (2001) to develop equations for predicting inactivation, and used data from Owens et al (1999) and Ruffell et al (2000) to validate the equations. The following equation can be used to determine the log credit between the indicated values in Table 5.5 in the DWSNZ:

$$\log \text{ credit} = 0.001506 \times 1.09116^{\text{temp}} \times \text{C.t}$$

C.t values are described in Chapter 15: Disinfection, sections 15.2.1 and 15.2.9.

Another step in developing the C.t values for *Cryptosporidium* inactivation involved consideration of the appropriate confidence bound to apply when analysing the inactivation data. A confidence bound represents a safety margin that accounts for variability and uncertainty in the data that underlie the analysis. Confidence bounds are intended to provide a high likelihood that water supplies operating at a given C.t value will achieve at least the corresponding log inactivation level in the C.t table. Two types of confidence bounds that are used when assessing relationships between variables, such as disinfectant dose and log inactivation, are confidence in the regression and confidence in the prediction. USEPA (2003a, 2006a) discusses these in the LT2ESWTR. The use of confidence bounds probably explains why the C.t values have increased, particularly at higher temperatures, since DWSNZ (2000).

Since the available data are not sufficient to support the C.t calculation for an inactivation level greater than 3 log, the use of the C.t table in the DWSNZ is limited to inactivation less than or equal to 3 log. In addition, the temperature limitation is 1–25°C. If the water temperature is higher than 25°C, the temperature should be set to 25°C for the log inactivation calculation.

#### 8.4.4.2 Ozone

##### Process description

The disinfectant ozone (O<sub>3</sub>) is made on site and can be dosed into the water supply to inactivate micro-organisms, including bacteria, viruses, and protozoa such as *Cryptosporidium*.

Operation of the process is discussed in Chapter 15: Disinfection, section 15.5.4. Refer also to Chapter 11 of the review draft LT2ESWTR Toolbox Guidance Manual (USEPA 2009) which discusses issues related to disinfection using ozone.

##### DWSNZ criteria

See section 5.15 of the DWSNZ for the protozoal compliance requirements that need to be satisfied in order to qualify for log credits. Disinfecting with ozone can cause bromate to exceed its MAV of 0.01 mg/L, so pilot trials are needed to determine acceptable dosage conditions. Alternatively, if the raw water bromide content is less than 0.006 mg/L, the bromate concentration should not exceed the MAV. In the unlikely event that the process is not being operated for the purpose of protozoal compliance, these requirements do not need to be met; theoretically, a water supply could achieve 3 log credits for disinfecting with chlorine dioxide or UV, or could earn 3 log credits using chemical coagulation, sedimentation, filtration, or membrane filtration, even if the ozone process is non-complying.

Section 5.15.2(6) of the DWSNZ states that flow measurements must be made continuously for supplies serving more than 500 people. Flow is an important component in calculating C.t. If a plant is said to be constant flow, the water supplier needs to be able to demonstrate that the flow is maintained within 10 percent of that flow for 95 percent of the time.



## Performance validation/certification

The validation process is reasonably complex so it would be expected that ozone appliances would be validated by the manufacturers. The appliance needs to comprise more than one reaction chamber (see Table 8.6).

The residual ozone is measured at a prescribed point in the ozone contactor to validate by challenge testing that it is able to achieve the required inactivation of test organisms. Chapter 5: Disinfection, section 15.5.4.3 discusses the sampling techniques, test methods and calibration procedure.

Chapter 11 of the review draft LT2ESWTR Toolbox Guidance Manual (USEPA 2009) discusses issues related to the measurement of contact time in different types of ozone generators and contactors.

Section 8.6.2.5 discusses C.t values and how to determine t in an ozone contactor.

## Determining ozone C.t

The protozoa log credits for various C.t values at different temperatures are given in Table 5.6 in the DWSNZ, taken from Table IV.D–3 in the LT2ESWTR (USEPA 2006a). See section 15.2.1 of the Guidelines for a fuller description of C.t. For ozone, the value used for C depends on the design of the reaction vessel/contactor.

| <b>Turbine</b> | <b>Co-current flow</b>              | <b>Counter-current flow</b> | <b>Reactive flow</b> |
|----------------|-------------------------------------|-----------------------------|----------------------|
| $C_{out}$      | $C_{out}$ or $(C_{in} + C_{out})/2$ | $C_{out}/2$                 | $C_{out}$            |

C.t can be calculated for an entire ozone contactor or for individual segments. The C.t for the individual segments can be summed to give a total C.t for all of the segments. C is measured at the beginning and end of an individual segment or at the end of the segment.

Chapter 11.3 of the review draft Ozone Toolbox Guidance Manual (USEPA 2009) describes how protozoa log credits are calculated for various ozone contactors. These are summarised in Table 8.6 (which is Table 11.2 in USEPA 2009).

**Table 8.6: Methods and terminology for calculating the log inactivation credit when using ozone**

a) **No tracer data**

| Section description                  | Terminology  | Method for calculating log-inactivation credit                                     | Restrictions   |
|--------------------------------------|--|--|--|
| <b>Chambers where ozone is added</b> |  |  |  |
| First chamber                        | First dissolution chamber                          | No log-inactivation credit is recommended  | None   |
| Other chambers                       | Co-current or counter-current dissolution chambers | CSTR* method in each chamber with a measured effluent ozone residual concentration | No credit is given to a dissolution chamber unless a detectable ozone residual has been measured upstream of this chamber  |
| <b>Reactive chambers</b>             |  |  |  |
| ≥ 3 consecutive chambers             | Extended-CSTR zone                                 | Extended-CSTR method in each chamber   | Detectable ozone residual should be present in at least three chambers in this zone, measured via in-situ sample ports<br>Otherwise, the CSTR method should be applied individually to each chamber having a measured ozone residual |
| < 3 consecutive chambers             | CSTR reactive chambers                             | CSTR method in each chamber  | None   |

Note: CSTR is continuously stirred tank reactor.

b) **With tracer data**

| Section description                  | Terminology  | Method for calculating log-inactivation credit   | Restrictions  |
|--------------------------------------|--|--|---|
| <b>Chambers where ozone is added</b> |  |  |   |
| First chamber                        | First dissolution chamber                          | No log-inactivation credit is recommended  | None  |
| Other chambers                       | Co-current or counter-current dissolution chambers | T <sub>10</sub> or CSTR method in each chamber with a measured effluent ozone residual concentration | No credit is given to a dissolution chamber unless a detectable ozone residual has been measured upstream of this chamber   |
| <b>Reactive chambers</b>             |  |  |   |
| > = 3 consecutive chambers           | Extended-CSTR zone                                 | Extended-CSTR method in each chamber   | Detectable ozone residual should be present in at least three chambers in this zone, measured via in-situ sample ports<br>Otherwise, the T <sub>10</sub> or CSTR method should be applied individually to each chamber having a measured ozone residual |
| < 3 consecutive chambers             | CSTR reactive chambers                             | T <sub>10</sub> or CSTR method in each chamber   | None  |

## Further information

The C.t table for ozone in the DWSNZ was taken from the LT2ESWTR (USEPA 2006a). It was based on Clark et al (2002) who used data from studies of ozone inactivation of *Cryptosporidium* in laboratory water to develop predictive equations for estimating inactivation (Rennecker et al 1999, Li et al 2001), and data from studies in natural water to validate the equations (Owens et al 2000, Oppenheimer et al 2000). The following equation can be used to determine the log credit between the indicated values in Table 5.6 in the DWSNZ:

$$\log \text{ credit} = 0.0397 \times 1.09757^{\text{temp}} \times \text{C.t}$$

Another step in developing the C.t values for *Cryptosporidium* inactivation involved consideration of the appropriate confidence bound to apply when analysing the inactivation data. A confidence bound represents a safety margin that accounts for variability and uncertainty in the data that underlie the analysis. Confidence bounds are intended to provide a high likelihood that water supplies operating at a given C.t value will achieve at least the corresponding log inactivation level in the C.t table. Two types of confidence bounds that are used when assessing relationships between variables, such as disinfectant dose and log inactivation, are confidence in the regression and confidence in the prediction. USEPA (2003a, 2006a) discusses these in the LT2ESWTR. The use of confidence bounds probably explains why the C.t values have increased at higher temperatures and decreased at lower temperatures since DWSNZ (2000).

Since the available data are not sufficient to support the C.t calculation for an inactivation level greater than 3 log, the use of the C.t table in DWSNZ is limited to inactivation less than or equal to 3 log. In addition, the temperature limitation is 1–25°C. If the water temperature is higher than 25°C, the temperature should be set to 25°C for the log inactivation calculation.

It has been reported that turbidities up to 5 NTU did not affect disinfection (Walsh et al 1980). However, economic problems are likely at this level of turbidity. Blakemore (personal communication) has noted that at Timaru she found the ozone demand increases dramatically with increasing turbidity, and an added problem at 5 NTU occurs when chlorine is added to maintain FAC in the distribution system. Therefore the DWSNZ set a limit of 1 NTU.

### 8.4.4.3 Ultraviolet light

#### Process description

UV disinfection is a physical process relying on the transference of electromagnetic energy from a source (lamp) to an organism's cellular material.

Operation of the process is discussed in Chapter 15: Treatment Process, Disinfection, section 15.5.5. A great deal of information appears in the Ultraviolet Disinfection Manual (USEPA 2006c), over 500 pages in fact, that covers every aspect of the use of the UV disinfection process for water supply. Refer also to Chapter 13 of the review draft LT2ESWTR Toolbox Guidance Manual (USEPA 2009) which discusses issues related to using UV disinfection.

## DWSNZ criteria

See section 5.16 of the DWSNZ for the protozoal compliance requirements that need to be satisfied in order to qualify for the claimed log credits. In the unlikely event that the process is not being operated for the purpose of protozoal compliance, these requirements do not need to be met.

UV disinfection can also be used to achieve bacterial compliance. Section 8.5 describes how UV appliances can be validated using either MS2 or T1 organisms. If the appliance is installed to inactivate bacteria as well as protozoa, the validation must have tested appropriate (eg, MS2) organisms.

## Performance validation/certification

UV disinfection systems do not produce a chemical residual, so a direct C.t approach as used for chlorine dioxide and ozone cannot be used. UV appliances used for protozoal compliance need to be validated or certified to demonstrate the dose that they are capable of delivering at different water qualities and flow rates.

The UV disinfection equipment manufacturer is responsible for obtaining and providing certification of validation; the equipment must be validated to meet the required log credit using one of:

- the *Ultraviolet Disinfection Guidance Manual* (USEPA 2006b): variable log credits
- DVGW Technical Standard W294 (DVGW 2006): 3 log credits
- öNORM M5873 (Osterreichisches Normungsinstitut 2001): 3 log credits
- NSF/ANSI 55\* for Class A systems (for populations of up to 5000): 3 log credits
- a validation procedure acceptable to the Ministry of Health.

\* UV disinfection systems that meet this standard can be found on the website <http://nsf.com/Certified/DWTU/>.

Note that at the time of writing the DWSNZ (2008 update), appliances covered by (a) mainly delivered a fixed dose (fluence) and claimed 3-logs, whereas appliances covered by (b) can claim 0.25 to 3.0 protozoal log credits, depending on the validated dose and operating conditions. The fixed dose of 40 mJ/cm<sup>2</sup> allows the appliance to be used to inactivate both bacteria and protozoa (oo)cysts, whereas using the UVDGM, a 12 mJ/cm<sup>2</sup> dose can earn 3 protozoal log credits (see Table 8.7 and section 8.5). The British Standards Institute produced BS EN 14987 (2006/07), an adaptation of the öNORM Standard, but without the requirement to allow for uncertainty in the UVI sensor readings; it only applies to UV devices treating water that has come from the public water supply.

Since the 2008 DWSNZ were published, the US National Water Research Institute (NWRI), in collaboration with the Water Research Foundation (WRF) has produced UV disinfection guidelines for drinking water and water reuse (NWRI 2012). These are based largely on procedures adopted by the California Department of Public Health for the review and approval of UV disinfection systems and implicitly apply to large-scale installations. They apply to LP and MP UV systems. These guidelines do not quantify specific pathogen inactivation or UV dose requirements, leaving it to appropriate regulatory agencies to determine these on a case-by-case basis. Performance standards are specified for UV intensity sensors. Validation by biosimetry is required. MS2 phage is the recommended challenge micro-organism where expected dose >20 mJ/cm<sup>2</sup>, and bounds are defined within which the calibration sensitivity curve for

MS2 phage must fall. To simulate lamp ageing, the output must be reduced to 50 percent unless some other value can be demonstrated by the manufacturer as representative of lamps at the end of their specified service life (DWI 2016).

The WQA in the US operates a Certification Scheme: Drinking Water Treatment Units which establishes product certification criteria for Point-of-Entry (POE), Point-of-Use (POU), and components that are categorised as Drinking Water Treatment Units (DWTUs). The requirements that the products will be assessed against are contained in DWTU standards, including: NSF/ANSI 42, NSF/ANSI 44, NSF/ANSI 53, NSF/ANSI 55, NSF/ANSI 58, NSF/ANSI 62, NSF/ANSI 177, NSF/ANSI 222, USEPA Microbiological Standard, CSA B483.1, WQA S-100, WQA S-200, WQA S-300, WQA S-400, NSF Protocol P231, and WQA ORD 0901. The WQA website ([www.wqa.org/](http://www.wqa.org/)) leads to 'Find Certified Products'. WQA is involved in other verification schemes too, so it is important to ensure that it is clear what standards any water treatment equipment is being tested against.

In most cases in New Zealand, UV appliances are validated off-site due to the complexities of onsite validation. Onsite validation is not discussed in these Guidelines. The manufacturer's validation is only applicable when the installed appliance is identical to the appliance that was tested, and the inlet and outlet hydraulic conditions are equal to or better than the conditions used in the validation process. Appliances will need to be revalidated if they are modified.

Validation testing of UV appliances must determine a range of operating conditions the appliance can monitor and under which the appliance delivers the required UV irradiance (dose), as measured by the UV intensity meter (UV sensor), to achieve the target log credit for a range of flows. These operating conditions must include, at least:

- flow rates
- UV intensity (fluence rate) as measured by a UV intensity sensor
- UV lamp status
- minimum UV transmittance of the water for which the UV appliance has been validated to achieve the target inactivation.

The validation procedure must take account of uncertainties in the disinfection system including uncertainties related to the velocity distribution, lamp aging and UV intensity sensors.

The validation certificate must:

- be an original, written in English, unique to the model of appliance
- have been written by the certifying authority, and describe the validation procedure
- state the qualifications of the certifying authority that conducted the validation. The validation testing must have third-party verification by an agency accredited to ISO/IEC 17025 (IANZ 2005) or by the New Zealand National Metrology Institute (or accreditation to an equivalent standard accepted by the Ministry of Health). The National DWAs Coordination team maintains a list of agencies that have been accepted by the MoH
- provide a detailed list of the components and dimensions of the appliance that had been validated and relate to the parts comprising the water supplier's appliance and to its name plate (or data plate) fixed to the appliance

- define what type of UV lamps are installed in the reactor, and clarifies the reasons for the choice of the aging/fouling factor, which is equal to the fouling factor multiplied by the aging factor and typically ranges from 0.4 to 0.9 (see section 5.4.6 of the UVDGM)
- show clearly the means by which the appliance was shown to comply with the requirements of the standard that it was tested against; these requirements will include the number of UV intensity sensors, the position of the sensors, the spectral response of the sensors, the variation in lamp UV output and the sensor uncertainty
- contain statements, graphs or tables clearly showing the range of UV transmittance and flow that the validation covered; where appropriate these graphs should also show the target dose (usually measured in  $\text{mJ}/\text{cm}^2$ ) that was certified for each UV transmittance and flow combination
- contain statements, graphs or tables showing clearly the UV intensity (ie, the sensor reading, usually in  $\text{mWs}/\text{cm}^2$ ) that is required at a given flow to produce a given target dose
- contain a detailed description of the inlet and outlet hydraulic conditions
- include a description of the measured headloss across the UV appliance
- include a description of the challenge micro-organism used and its dose response curve that was generated as part of the validation
- include a description of how uncertainty arising from the number of experimental data points has been taken into account in setting the target dose and related sensor reading.

The end-user should use the validation report to ensure that all aspects of the validation process are applicable to the specifics of the proposed application. This review at a minimum should cover the inlet and outlet piping configurations and the operating range of UV transmittance and flow to provide the required dose.

The performance of the equipment when installed should be verified against the validation at the end of lamp life. The time to reach the end of lamp life condition is itself an important performance criterion for a UV system. The end-user should require that the UV equipment pass a performance test at the end of lamp life, typically this will occur after at least 12 months of operation. The appliances will also include a system that continuously monitors lamp status.

Note: The amount of inactivation that is achieved is a function of the amount of UV light that the micro-organisms receive. This is called the UV dose, or more correctly, the fluence. The SI units of UV dose are  $\text{J}/\text{m}^2$ . The units of  $\text{mJ}/\text{cm}^2$  are also used.  $1 \text{ mJ}/\text{cm}^2$  is equal to  $10 \text{ J}/\text{m}^2$ . The dose is the product of the intensity of UV light and the time that the micro-organisms are exposed to it (which means related to flow). The unit of intensity is watts (W). The unit of time is seconds (s). Consequently the dose is sometimes referred to as  $\text{mW}\cdot\text{s}/\text{cm}^2$  or  $\text{W}\cdot\text{s}/\text{m}^2$ . One  $\text{mJ}/\text{cm}^2$  is equal to  $1 \text{ mWs}/\text{cm}^2$ .

UV equipment manufacturers are increasingly claiming that their validation documentation (and some exceed 300 pages) is commercially sensitive and not available to regulatory bodies. Instead they offer much abbreviated reports or simply state that the appliance meets requirements. In conjunction with the major New Zealand importers of UV equipment, the MoH has developed a template questionnaire to overcome this difficulty. It is reproduced below, and is followed by explanations.

## Template for UV disinfection: evidence of validation

### 1. The water being disinfected

- a. Water treatment plant
- b. WINZ number
- c. Water supplier
- d. Protozoal log credit categorisation
- e. Target protozoal log credits by UV
- f. For protozoal compliance (5.16) or both protozoal and bacterial (5.16 plus 4.3.5)
- g. Design UVT range, %T (10 mm)

### 2. The UV disinfection system

- a. Manufacturer
- b. Model
- c. Serial number(s)
- d. Number of reactors
- e. Lamp type
  - LP, or
  - LPHO, or
  - MP, or
  - Other
- f. Importer/New Zealand agent; contact name
- g. Water supplier's consultants; contact name
- h. Installed by, and date commissioned

### 3. The validation

- a. 'Standard' validated to, under which compliance is sought
  - i) DVGW
  - ii) ÖNORM
  - iii) NSF
  - iv) UVDGM
  - v) Other (specify)
- b. Relevant validation testing body
- c. Validation certificate/report signed by, and date
- d. The validation testing body has third-party verification by an agency accredited to:
  - i) ISO/IEC 17025 (IANZ 2005) or
  - ii) to an equivalent standard accepted by MoH
- e. Challenge micro-organism used for standard under which compliance is sought:
 

|                          |                         |
|--------------------------|-------------------------|
| <b>Microorganism(s)</b>  | <b>RED range tested</b> |
| <i>Bacillus subtilis</i> | mJ/cm <sup>2</sup>      |
| MS-2 coliphage           |                         |
| T1                       |                         |
| T7                       |                         |
| Other                    |                         |
- f. UVT (% , 10 mm) and flow range covered in validation
 

|            |                     |
|------------|---------------------|
| <b>UVT</b> | <b>Flow (units)</b> |
|------------|---------------------|
- g. Components in use during validation:
  - Lamp
  - Sleeve
  - Ballast
  - Duty sensor
  - Sensor window

Evidence:

  - i) Sighted validation report:
  - ii) Declaration – append
- h. Number of lamps per reactor
- i. Number of sensors per reactor

- j. Change lamps at *x* hours run time
- k. Do hydraulics of installed appliance meet the validation conditions?
- Yes:  
No:  
Comment:

#### 4. Dosage control

Either: **The UV Intensity Setpoint Approach**

- a. UVT measured online or in lab?
- b. Define the relationship between flow, UVT and intensity

Or: **The Calculated Dose Approach**

- c. Describe how a DWA can be certain that the appliance is operating within its validated condition
- i) A signed declaration from manufacturer’s senior management – append  
ii) Other:
- d. What is the dose alarm setpoint?  
What is the maximum validated flow?

#### 5. Standardisation

##### Sensors

- a. How is the duty sensor checked that it is within specification? Append as required.
- i) vs reference sensor  
ii) Other traceable procedure
- b. What tolerance is allowed before remedial action is required?
- c. What action is specified for when the duty sensor is out of specification?
- d. What supporting documentation describes original reference sensor standardisation? Append if possible.
- Standard:  
Issued by:  
Date:
- e. How is the reference sensor standardised at the water treatment plant?
- i) As per UVDGM  
ii) Other traceable procedure  
iii) Replaced annually

##### UVT

- f. How is UVT instrument standardised?
- i) Manual UVT:  
ii) Online UVT:
- g. At what frequency?

#### 6. Alarms

- a. How is the UV appliance set to warn of transgressions?
- UV dose:  
UV sensor (intensity meter):  
UVT:  
Turbidity:  
Flow:  
Other (describe):

#### 7. Monitoring

(water supplier to complete those questions that are not appropriate for the UV vendor to complete)

- a. Where are the results of standardisations recorded?
- b. What remedial action will be followed when the duty sensor is out of specification?
- c. At what frequency will each alarm condition be verified?
- d. Monitoring results have to be reported. Who is responsible?
- i) The UV people:  
ii) Consultants/contractors:  
iii) The water supplier:
- e. Will the reporting requirements of section 3.2 of DWSNZ be met?
- i) Third party verification:  
ii) Other:



## Commentary on items in the template

- **General:** The USEPA's UVDGM is a guidance manual, but in this document it is treated as though it were a 'standard', because referencing it in the DWSNZ effectively makes it a standard.
- **1c:** The MoH has allocated a unique identifier to every water source and treatment plant.
- **1d:** Protozoal log credit categorisations are determined or signed off by DWAs.
- **2a:** Some UV appliances are made by more than one manufacturer – list equivalents.
- **2b:** Some models of UV appliances go by more than one name – list equivalents.
- **2f:** This question relates only to UV disinfection.
- **3 (general):** DVGW and ÖNORM include an expiry date on their certificates. The MoH accepts that if an appliance continues to meet the original validation, the expiry date may be ignored.
- **3a:** Some appliance models are validated to more than one standard. Where this is so, record both, but indicate which one applies to this water treatment plant.
- **3e:** RED is reduction equivalent dose, a term used in North America. It is the same as REF which is reduction equivalent fluence, a term used in Europe. ÖNORM describes it as the "average microbiocidal fluence measured by the biosimulator according to Annex d in the irradiation chamber, in  $J/m^2$ ". The UVDGM describes it as 'see UV dose', which reads: "the UV energy per unit area incident on a surface, typically reported in units of  $mJ/cm^2$  or  $J/m^2$ ". The UV dose received by a waterborne microorganism in a reactor vessel accounts for the effects on UV intensity of the absorbance of the water, absorbance of the quartz sleeves, reflection and refraction of light from the water surface and reactor walls, and the germicidal effectiveness of the UV wavelengths transmitted". Note that  $40 mJ/cm^2 = 400 J/m^2 = 40 mW-s/cm^2$  (also written as  $40 mWs/cm^2$ ).
- **3f:** If units are SSK-254/m, convert to %T (10 mm), but enter both.
- **3g:** A DWA needs to know that the installed appliance comprises the same parts as the appliance that was validated, hence the need for part numbers. If the part numbers have changed between validation and delivery, some form of verification from the manufacturer will be required. If the delivered parts are not the same, a new validation certificate will be required. If the validation report/certificate is not sighted in New Zealand, the manufacturer needs to provide a signed declaration that the parts supplied are the parts that underwent validation. If the New Zealand agents have the validation report/certificate but it is not available to others, the New Zealand agent/importer needs to provide a signed declaration that the parts supplied are the parts that underwent validation.
- **3j:** The hours run meter must incorporate the effect of on/off switching.
- **3k:** Flow patterns can exert a major effect on inactivation efficacy.
- **4:** Section 5.16.2 of DWSNZ includes: "The validation certificate must define the operating conditions under which the reactor can deliver the UV dose required by the validation procedure".
- **4a:** Population based – see Table 5.7 in DWSNZ.
- **4b:** This can be in the form of an appended graph, equation or table.

- **4c:** The Calculated Dose Approach uses a dose-monitoring equation or algorithm to estimate the UV dose, based on operating conditions (typically flow rate, UV intensity, and UVT). The dose-monitoring equation is usually developed during validation testing, and is incorporated in the 'black box' that controls dosage. Using the Calculated Dose Approach makes it difficult to check that the operating conditions under which the reactor delivered the UV dose in the validation procedure are actually being met.
- A declaration from senior management of the manufacturer that the algorithm/program used during validation has been incorporated in the control system, followed by a declaration from senior management of the importer/New Zealand agent that the algorithm/program has not been changed should suffice.
- **5a, b, c and d:** The manufacturer/importer/agent needs to set these up for the water supplier.
- **5e:** The reference sensor must have appropriate documentation, traceable to ISO 17025 or equivalent standard accepted by MoH.
- **5f:** This can be by following the manufacturer's procedure, or cross-checking against a lab bench instrument. If an online UVT monitor takes more than 15 minutes to standardise or maintain (eg, for cleaning) it shall not be deemed to have failed to comply with section 5.16.1, part 5a(i)C (which refers to a three-minute period).
- **5g:** The manufacturer needs to tell the water supplier how often to standardise the UVT.
- **6 (general):** This section refers to alarms that indicate transgressions, non-compliances and failures etc. It is expected a lower level of alarm will warn the operation of impending transgressions or maintenance requirements, etc.
- **6a:** Whether these alarms are provided will depend on the dosage control system in operation.
- **6b:** If the alarm system is part of the procedure that is involved in indicating compliance, it needs to be sufficiently sensitive, and of course, still 'alive'. The manufacturer/importer/ agent needs to include this facility. An alarm that indicates just 'on' or 'off' is not sufficient. A more sensitive technique is needed, eg, noting the response when a sensor is removed slightly, or a slight reduction in lamp power.
- **7 (general comments):** The procedure used for monitoring compliance may be provided by the UV appliance manufacturers, the New Zealand importers/agents, consultants/ contractors, or the water supplier. But ultimately, it is the responsibility of the water supplier to ensure that the monitoring requirements of the DWSNZ are met.

Section 3.2 of the DWSNZ includes:

Compliance with the DWSNZ requires some determinands not to exceed a certain value for more than three, five or 15 minutes. This requires accuracy in time measurement and recording to ensure no short-term transgressions go unrecorded. Generally, for remote measurements, unless a high-speed communications network is used, this requires the remote terminal unit to time-stamp the data as it is recorded. The sampling frequency must be as specified above. Where this cannot be achieved at present, suitable equipment must be installed and operating as stated in section 69C of the Act.

The data records may be compressed using a procedure that preserves the accuracy of the original measurements. Data must be reported as a percentage of the time (or duration, where required) that the value was exceeded (or met) during the compliance monitoring period.

In section 5.16, the compliance monitoring period for continuously monitored parameters is one month; for all other measurement frequencies the compliance monitoring period is one year. DWAs cannot be expected to analyse thousands of data points – for example, there are 43,200 minutes in a 30-day month. If the data cannot be presented in a summarised format that readily shows compliance, the DWA will deem it as failing to comply.

- **7e:** The accuracy of the procedure used to convert online monitoring data to the compliance report sent to the DWA needs to be verified by an appropriately qualified third party.

## Calibration and monitoring

The 2005 DWSNZ required the UV dose (fluence) to be not less than the reduction equivalent dose (RED) target required for the claimed log credit .... The 2008 DWSNZ require the UV irradiance (intensity or sensor reading) to be not less than the value established by validation required to achieve the claimed log credit .... The switch from UV dose to UV intensity was because the dose is 'what comes out of the lamp' while intensity (dose delivery) is 'what hits the most distant (oo)cyst', which is more logical operationally. However, the approach used, which depends on the manufacturer, is not the critical point. What is important is that the monitoring system indicates that the appliance is being operated within the conditions of its validation.

### UV intensity sensors

UV intensity sensors measure the intensity of the germicidal UV light at a specified distance from a set of UV lamps. Sensors are discussed further in section 8.6.2.6 (this chapter).

The reference sensor must be standardised at least annually in accordance with *Ultraviolet Disinfection Guidance Manual* (USEPA 2006c) or other traceable procedure, with third-party verification given by an agency accredited to ISO/IEC 17025 (IANZ 2005) for this type of standardisation, or by the Measurement Standards Laboratory of New Zealand (or accreditation to an equivalent standard accepted by the Ministry of Health).

A UV disinfection appliance (called reactor by USEPA) may contain one or more UV lamps. Appliances may contain one or more UV sensors. Section 6.3.2.2 of USEPA (2006c) states:

UV lamp output differs for each lamp, depending on lamp age and lot. However, a UV sensor cannot measure lamp output variability unless each lamp has a UV sensor. Water suppliers that have UV reactors with a UV sensor monitoring more than one lamp should assess the UV lamp variability every two months for MP lamps or every three months for LP and LPHO lamps. If all the lamps monitored by a UV sensor are close in age (ie, their age varies by less than 20 percent), it is not necessary to check the output of each lamp. In this case, the oldest lamp should be placed in the position nearest the UV sensor.

There should be at least one UV intensity sensor for every 10 LP or LPHO lamps (see DVGW) and the number and type of intensity sensors must be the same as for the unit that was certified or validated. These sensors are called duty sensors and are in continuous use.

All UV appliances will have at least one duty UV intensity sensor as an integral part; they all need to be calibrated against the reference sensor at regular intervals as required by the standard that they were certified to, or monthly as per section 5.16.2(b) in the DWSNZ, whichever is the more frequent.

The reference sensor is to be calibrated at least annually, in accordance with the validating authority, eg, USEPA 2003d/2006c. The calibration must be done by an accredited person or organisation, see section 5.16.3 of DWSNZ. However, due to the cost of sending a sensor overseas for recalibration, the DWSNZ allow reference sensors to be used as duty sensors (in lieu of recalibration) and a new calibrated sensor can be purchased for use as a replacement reference sensor. DVGW W294.3 allows duty sensors to be used up to two years if they remain within tolerance.

#### UV intensity sensor measurement uncertainty

Duty sensor calibration is discussed in section 6.4.1.1 of USEPA (2006c). The duty sensor is considered to be operating satisfactorily if it reads less than 20 percent lower than the reference sensor reading (preferably mean values of several readings). If it is outside the 20 percent allowance, immediately check that the reference sensor is still correct. If it is, then change the duty sensor. USEPA states that it is permissible to continue using the duty sensor with a correction factor. However, this is said to be not energy-efficient. It is not acceptable for the duty sensor to read as much as 20 percent higher than a calibrated reference sensor, 10% would be the absolute maximum.

#### UV transmittance

Some UV disinfection systems automatically adjust the UV dose as the UV transmittance (measured at 253.7 nm) of the water flowing through the appliance varies. The UV transmittance requirements in section 5.16.1(5) of the DWSNZ do not apply to these appliances.

Other appliances rely on the UV transmittance of the water not being less than that noted during the validation. UV transmittance needs to be monitored when using appliances of this type. If the population served is more than 10,000, UV transmittance is required to be monitored continuously. Only one UV transmittance meter that monitors the combined water that passes into or out of the UV disinfection plant is required.

The DWSNZ require less frequent monitoring for systems that serve fewer than 10,000 people, but the end-user should investigate the cost and benefit of installing a continuous UV transmittance monitor.

Water suppliers must take care to note the units for UV transmittance on their validation certificate. The readings are not always reported for the traditional 10 mm path length. Annex C in ÖNORM (2001) is a table that relates UV transmittance readings at 100, 50 and 10 mm path lengths; it includes a column headed SSK per metre (spectral attenuation coefficient) which we call UV absorbance (10 mm) except SSK per metre is numerically 100 times larger. Appendix A1.5.9 in the DWSNZ shows how to convert UV absorbance to UV transmittance. Examples follow:

- say the absorbance is 0.0721 (as measured in a 10 mm cell), ie,  $A_{10\text{ mm}} = 0.0721$
- to convert to transmittance, see DWSNZ Appendix A1.5.9, which states  $A = -\log T$
- therefore  $0.0721 A = 0.847 T$ , or 84.7%T.

Using ÖNORM:  $84.7\% T_{10\text{ mm}} = 43.6\% T_{50\text{ mm}} = 19\% T_{100\text{ mm}} = 7.212 \text{ SSK/m}$   
(=  $0.0721 A_{10\text{ mm}}$ ).

That is:  $\%UVT = 10^{-(SSK/100)}$  where SSK is SSK/m and measured at 254 nm.

USEPA (2006a) states in section 6.4.1.2 that online UVT analysers be standardised at least weekly by comparing the online UVT measurements with UVT measurements using a bench-top spectrophotometer. The bench-top spectrophotometer should be maintained and standardised at the frequency required by the manufacturer. The standardisation monitoring frequency can be decreased or increased based on the performance demonstrated over a one-year period. USEPA considers the online reading to be satisfactory if it is within 2 percent of the bench-top spectrophotometer reading.

### Turbidity

Section 5.16.1 of the DWSNZ stipulates the turbidity requirements for the water passing through the UV appliances.

### Flow measurement

The DWSNZ requires that all appliances serving more than 500 people have a dedicated flow meter and the flow through the appliance needs to be limited to not more than the flow for which the appliance was validated. The flow through appliances serving a smaller population also needs to be limited to less than the flow for which the appliance was validated.

### Alarms

Monitoring equipment should be connected to alarm devices to notify when operators are required. All alarm events should be recorded. USEPA (2006c) discusses (section 4.3.3) the use of minor, major and critical alarms.

### Records

To avoid misinterpretation over meeting validation requirements, it is strongly recommended that a detailed diary be kept of plant operations, calibrations, maintenance and replacement of lamps etc. See Annex G in ÖNORM (2001) for further information.

## Further information

The USEPA (2003a, 2006a) considered that a major recent development was the finding that UV light is highly effective for inactivating *Cryptosporidium* and *Giardia* at low doses. Research prior to 1998 had indicated that very high doses of UV light were required to achieve substantial disinfection of protozoa, ie, to kill them. These results were based largely on the use of in vitro assays, which were later shown to substantially overestimate the UV doses required to prevent infection (Clancy et al 1998, Bukhari et al 1999, Craik et al 2000). Research using in vivo assays (eg, neonatal mouse infectivity) and cell culture techniques to measure infectivity has provided strong evidence that both *Giardia* and *Cryptosporidium* are highly sensitive to low doses of UV, ie, are inactivated.

USEPA (2006a) stated that even though microbial repair can occur, neither photorepair nor dark repair is anticipated to affect the performance of drinking-water UV disinfection.

These studies demonstrated that a dose of 10 mJ/cm<sup>2</sup> was able to achieve *Cryptosporidium* inactivation of at least 3 log, compared with a typical UV dose for general water supply disinfection being about 30–40 mJ/cm<sup>2</sup> (or 300–400 J/m<sup>2</sup> in ISO units). Table 8.7 (taken from Table 1.4 of USEPA 2006c) shows the relationship between UV dose and available log credits for protozoa inactivation.

Qian et al (2004) performed a meta-analysis of a number of drinking-water UV efficacy studies and concluded that doses up to 20 mJ/cm<sup>2</sup> are necessary to achieve at least a 3-log (99.9 percent) reduction of *Giardia* cysts and *Cryptosporidium* oocysts, with at least 95 percent confidence (ie, no more than a 5 percent risk of failing to meet that level of reduction).

**Table 8.7: UV dose requirements for *Cryptosporidium* inactivation credits**

| Log credit           | UV dose (mJ/cm <sup>2</sup> )     |
|----------------------|-----------------------------------|
| 0.5                  | 2                                 |
| 1.0 (90% removal)    | 3                                 |
| 1.5                  | 4                                 |
| 2.0 (99% removal)    | 6                                 |
| 2.5                  | 9                                 |
| 3.0 (99.9% removal)  | 12                                |
| 3.5                  | 15 (not applicable in DWSNZ 2008) |
| 4.0 (99.99% removal) | 22 (not applicable in DWSNZ 2008) |

These doses (rounded to whole numbers) are based on UV light at 254 nm as delivered by a low pressure mercury vapour lamp. The doses can be applied to other lamps such as medium pressure through reactor validation testing.

USEPA (2003a) states that to receive disinfection credit for a UV reactor, manufacturers are required to demonstrate through validation testing that the reactor can deliver the required UV dose. The USEPA developed dose requirements for *Cryptosporidium* that account for the uncertainty associated with the dose-response of the micro-organisms in controlled experimental conditions. In practical applications, other sources of uncertainty are introduced due to hydraulic effects, UV reactor equipment, water quality, and sensor quality. The validation protocol applies a safety factor to the dose requirements to account for these areas of uncertainty and variability.

DWI (2010) states that the absorbance of UV light by nitrate (at wavelengths below 240 nm) can lead to the formation of nitrite by photolysis. This can be managed through the selection of UV lamp or sleeve type.

## 8.4.5 Other processes and other log credit determinations

The USEPA included in their LT2ESWTR Final Rule (USEPA 2006a) a section called *Demonstration of Performance*, basically to cover processes and procedures not specified in detail in the LT2ESWTR. Refer also to Chapter 12 of the review draft LT2ESWTR Toolbox Guidance Manual (USEPA 2009).

As a consequence, the 2008 DWSNZ include a new section, section 5.17: Alternative processes: treatment compliance criteria, whereby water suppliers may apply to the Ministry of Health to have other treatment processes assessed for a log credit rating. This approach allows water suppliers to apply for a log credit rating (or a variation to the prescribed log credits) for a treatment plant or process:

- a) not covered in sections 5.1–5.16 of the DWSNZ
- b) that performs demonstrably better than its compliance criteria
- c) that performs to a lesser, but reliable, level than specified in its compliance criteria.

### a) Treatment processes not covered in sections 5.1–5.16 of the DWSNZ

Any water supplier or equipment supplier that wishes to use a treatment process not covered in sections 5.1–5.16 of the DWSNZ, and it is considered to be effective in the removal or inactivation of protozoal (oo)cysts, can apply to the Ministry of Health for an assessment to decide whether the process qualifies for any log credits.

If it appears to qualify, then the next step will be to determine the number of log credits allowed, and the criteria that will need to be satisfied in order to qualify for those log credits.

The application will need to be made before installing the equipment or process. The information that will be needed with the application will include:

- a description of the quality of the raw water that will be treated
- a detailed description of the treatment process and its limitations
- the intended maximum (and minimum if relevant) treatment rates
- results from a bench-scale and/or pilot plant challenge test
- the operating parameters that need to be met in order to confirm the claimed log removal
- and where possible a quantitative description of the performance of the full-scale process elsewhere, including details of (oo)cyst removal/inactivation or equivalent, including:
  - a description of the water the process treated
  - the treatment rates or loading rates the data provided relate to
  - monitoring results.

The supporting data supplied must have been generated by organisations accredited by appropriate agencies acceptable to the Ministry of Health.

As shown by the USEPA (2006a) when assessing treatment processes in developing their LT2ESWTR, any water treatment plant using a new process should earn fewer log credits than it achieved in bench-scale or pilot plant challenge tests. Reasons include:

- variations in treatment rate can affect treatment performance
- variable raw water composition can affect treatment requirements and performance
- variable water temperature can affect treatment performance
- whether all plants using the new process will operate similarly
- deterioration in treated water quality as a treatment cycle progresses
- wear and tear/maintenance problems of the process
- the skill level required by operators
- the degree of difficulty in maintaining optimum performance
- the time for the process to recover after a problem has been identified and rectified.

The number of log credits a new process is awarded would probably relate more closely to the results presented from a full-scale plant, provided it was operating 'normally' during the testing. However, there will be difficulties if the full-scale plant is producing drinking-water, because, in general, the degree of removal that can be quantified in full-scale plants is limited because *Cryptosporidium* oocyst levels following filtration are often below the detection limit of the analytical method. Due to the shortage of data relating to oocysts, the USEPA (2003a, 2006a) evaluated data provided by water suppliers on the removal of other types of particles, mainly aerobic spores, in the sedimentation processes of full-scale plants. Data indicate that aerobic spores may serve as a surrogate for *Cryptosporidium* removal by sedimentation provided optimal chemical dosage conditions apply (Dugan et al 2001). This is discussed further in section 8.5, along with other monitoring techniques such as particle counting.



Due to the above, a regulatory authority is likely to err on the side of safety. Safety measures include requiring another treatment to be included while the new process undergoes in situ evaluation. For example, if a source water needs 3 log removals, the new process could be evaluated while the water was being disinfected by UV light, equivalent to a 3-log dose. If the new process is awarded say 2 log credits, the UV disinfection dose rate could then be reduced.

If a new process satisfies the above, compliance criteria specific to that process and site will be developed.

## b) Treatment that performs demonstrably better than its compliance criteria

The prescribed log credits for treatment processes in the DWSNZ are based on conservative estimates of mean *Cryptosporidium* removal efficiencies. Due to site-specific conditions, some treatment plants may consistently achieve greater *Cryptosporidium* removal than reflected in the prescribed log credits. Water suppliers may receive log credits for a water treatment plant or a treatment process within a plant that is based on demonstration of *Cryptosporidium* removal efficiency. Demonstration of performance testing will be specific to a particular site and will depend on the treatment processes being tested, water quality, plant infrastructure, technical and management resources, and other factors. Demonstration of performance testing should encompass the full range of expected operating conditions, and cover at least a year's continuous operation.

Demonstration of *Cryptosporidium* removal efficiency will usually not be possible, so indirect techniques will generally be needed. These may include monitoring the removal of aerobic or anaerobic spores, or using particle counting, see section 5.5. The supporting data supplied must have been generated by organisations accredited by appropriate international agencies acceptable to the Ministry of Health. If the supporting data is satisfactory, compliance criteria specific to that process and site will be developed.

Treatment plants cannot claim additional log credits by this process if they are already claiming log credits for individual processes. For example, a coagulation/sedimentation/filtration plant (DWSNZ section 5.4) cannot claim demonstration of performance log credits if it is also claiming log credits for enhanced combined filter performance (DWSNZ section 5.7).

Treatment plants claiming 3 log credits for an existing disinfection process cannot increase this by demonstration of performance. If a water supply needs more than 3 log credits for protozoal compliance, a filtration technique should provide the additional log credits, ie application of the multiple barrier principle.

### c) Treatment that performs to a lesser but reliable level specified in its compliance criteria

Some treatment processes may fail to satisfy the compliance criteria prescribed for that process by a small margin. It is considered unreasonable to award zero log credits for that process if it can still demonstrate a measurable, but lesser, consistent removal of *Cryptosporidium*. This option is only available to processes that fail to satisfy their compliance criteria by a small margin. It does not apply to plants that cannot cope with peak flows, turbid water after heavy rain, cold water, power failures or other conditions that a process or plant would be expected to handle effectively.

Also, some treatment processes may be validated for a higher log credit than the source water requires. For example, source water that requires 3 log removals may be treated by a membrane filtration plant that is validated to remove 4.0 logs if it achieves a specified particle removal rate. A water supplier may be able to demonstrate 3.5 log removals (for example) if it achieves a slightly less demanding particle removal rate.

Demonstration of *Cryptosporidium* removal efficiency will usually not be possible, so indirect techniques will generally be needed. These may include monitoring the removal of aerobic or anaerobic spores, or using particle counting, see section 8.5. The supporting data supplied must have been generated by organisations accredited by appropriate international agencies acceptable to the Ministry of Health. If the supporting data is satisfactory, compliance criteria specific to that process and site will be developed.

Demonstration of performance testing should encompass the full range of expected operating conditions, and cover at least a year's continuous operation.

## Iodine

Although disinfection by iodine is not covered in the DWSNZ, some field treatment units use the process (see Chapter 15). Most (oo)cysts appear to be more resistant to iodine disinfection than are bacteria or viruses. Iodine is capable of providing a 3-log *Giardia* cyst inactivation, but additional contact time or higher doses are necessary at colder water temperatures and more turbid waters. Warmer waters (>20°C), both clear and cloudy, with pH levels ranging from 6–9, resulted in >2.7 log *Giardia* cyst inactivation with C.t values ranging from 45–241 mg-min/L. As water temperatures decreased C.t values for >2.7 log *Giardia* cyst inactivation increased, ranging from 123–600 mg-min/L (clear and cloudy waters; pH ranged from 6–9). Pentaiodide resins are much more effective at inactivating *Giardia* cysts than triiodide resins. A pentaiodide resin achieved 3-log *Giardia* cyst inactivation compared with 0.2–0.4-log inactivation achieved by triiodide resin under identical experimental conditions (temperatures of 4 and 25°C). From USAPHC.

## Boiling

WHO (2015) states that *Cryptosporidium parvum* oocysts are inactivated in less than one minute once temperatures exceed 70°C. The data for *Giardia* cysts are more limited, but inactivation at temperatures ranging from 50°C to 70°C has been reported.

Based on these results, it is considered that the process of heating water to a rolling boil, as recommended in the WHO *Guidelines for Drinking-water Quality* (WHO 2011), is sufficient to inactivate pathogenic bacteria, viruses and protozoa. After the water has reached a rolling boil, it should be removed from the heat, allowed to cool naturally, without the addition of ice, and protected from post-treatment recontamination during storage. If turbid water needs to be clarified for aesthetic reasons, this should be done before boiling.

## 8.5 Challenge testing

Normally it would be expected that the manufacturer of the treatment process would conduct the challenge test. However, for some treatment processes, there is no reason why a water supplier cannot arrange to have this done in New Zealand.

### 8.5.1 Using *Cryptosporidium* oocysts

Although use of *Cryptosporidium* as the challenge particulate offers the advantages of directly measuring removal efficiency, and eliminates issues regarding the appropriateness of a surrogate, it may not be practical or feasible due to economic considerations (particularly in large plants), or to health concerns about working directly with the pathogen. Thus the use of surrogates may be the most viable option for challenge testing.

The use of other organisms and molecular markers is discussed in the Membrane Filtration Guidance Manual (USEPA 2003c, 2005a).

### 8.5.2 Using microspheres

Microspheres can be used for measuring the removal efficacy of filtration processes. EPA/NSF ETV (2002) describes the technique in detail, in their sections 12.3.3, 12.4.2 and 14.9. For testing involving microscopic enumeration, fluorescent microspheres and an optical microscope equipped with ultraviolet illumination are used.

### 8.5.3 Using naturally occurring bacteria

Rice et al (1996) stated:

Monitoring for indigenous spores of aerobic spore-forming bacteria represents a viable method for determining treatment plant performance. Comparison of spore levels in source water and filter effluents provides an indication of biological particle removal efficiency.

Section 8.4.1.2 Challenge Particulate in the LT2ESWTR Toolbox Guidance Manual Review Draft discusses the use of surrogates for challenge testing, examples being *P. dimunita* and *S. marcessans* (USEPA 2009).

The heterotrophic plate count may be a suitable (and cost-effective) test. A membrane filtration laboratory method is needed so large volumes can be filtered. Trials would be needed for each water supply to see how much water needs to be filtered. With low turbidity water it should be possible to filter 5–10 litres to ensure a reasonable number of bacteria grow. Also, the optimum incubation temperature and time will need to be determined. Some may need to be incubated at 22°C (or even room temperature if an incubator is not available) for 72 hours. An example follows:

- say 25 mL of raw water is filtered through the membrane and incubated, and 200 colonies are counted = 8000 CFU/L
- say 5 L of treated water is filtered through the membrane and incubated, and 40 colonies are counted = 8 CFU/L
- that equals 99.9 percent removal (3 log), which should give confidence that the treatment process was removing the larger protozoa effectively.

## 8.5.4 Bag and cartridge filter challenge

Bag and cartridge filter manufacturers commonly rate their products by pore size or pore distribution. However, there is no industry standard for measuring or reporting these characteristics. This lack of standardisation causes problems for establishing design criteria to ensure that a given bag or cartridge filter will effectively remove a given percentage of *Cryptosporidium*. Furthermore, an oocyst has different structural characteristics than the markers used to determine pore size; thus, the rate of rejection may differ for an oocyst versus the test markers used to determine pore size or molecular weight cut-off.

To compensate for these factors of uncertainty for *Cryptosporidium* removal, the DWSNZ require bag or cartridge filters to be challenge tested, a process in which a known quantity of *Cryptosporidium* oocysts (or an acceptable surrogate) is added to the filter influent and the effluent concentration is measured to determine the removal capabilities of the filter. This testing is product-specific, not site-specific, meaning it does not have to be tested at every water supply seeking removal credit. Instead, a manufacturer (or independent third party) must challenge test each of its products in order to obtain a 2 or 3 log *Cryptosporidium* removal rating. Details for the challenge test that relate specifically for bag and cartridge filtration appear in section 8 of the review draft Toolbox Guidance Manual (USEPA 2009). More general requirements are the same as membrane filtration.

## 8.5.5 Membrane filter challenge

The material below has been taken from the Membrane Filtration Guidance Manual (USEPA 2003c, 2005a). The introduction has been copied in full. The chapters' titles are listed to indicate the information that is available in the Guidance Manual (about 330 pages).

### 3.1 Introduction

The LT2ESWTR requires that any membrane filtration system used to comply with the *Cryptosporidium* treatment requirements of the rule undergo challenge testing. The primary purpose of this challenge testing is to establish the log removal that an integral membrane can achieve.

Under the LT2ESWTR, the maximum removal credit that a membrane filtration system is eligible to receive is the lower of the two values established as follows:

- the removal efficiency demonstrated during challenge testing; or
- the maximum log removal that can be verified by the particular direct integrity test used during the course of normal operation.

The requirement for challenge testing under the LT2ESWTR is intended to be product-specific such that site-specific demonstration of *Cryptosporidium* removal efficiency is not necessary. Once the log removal of a membrane has been established through a challenge test that meets the requirements of LT2ESWTR, **additional challenge testing is not required unless significant modifications are made to the membrane process** (as discussed in section 3.14). The rule specifies criteria for the following aspects of challenge testing:

- full-scale vs small-scale module testing
- appropriate challenge particulates
- challenge particulate concentrations
- test operating conditions
- calculation of removal efficiency
- verifying characteristic removal efficiency for untested modules
- module modifications.

The discussion of challenge testing applies similarly to microfiltration, ultrafiltration, nanofiltration, and reverse osmosis, except as otherwise noted.

Although the primary focus of challenge testing as required under the LT2ESTWR is demonstration of *Cryptosporidium* removal, the general framework for challenge testing developed in this guidance manual may be adapted for use in establishing removal efficiencies for other microbial pathogens of concern, including bacteria, viruses, and other protozoa such as *Giardia*.

Chapter 3 is organised into sections that describe the various issues to be considered in the design and implementation of a challenge test.

- Section 3.2: Summary of challenge testing requirements
- Section 3.3: Test organisation qualification
- Section 3.4: General procedure for developing a challenge test protocol
- Section 3.5: Module specifications
- Section 3.6: Non-destructive performance testing
- Section 3.7: Selection of modules for challenge testing
- Section 3.8: Small-scale module testing
- Section 3.9: Target organisms and challenge particulates
- Section 3.10: Challenge test solutions
- Section 3.11: Challenge test systems
- Section 3.12: Sampling
- Section 3.13: Analysis and reporting of challenge test results
- Section 3.14: Re-testing of modified membrane modules
- Section 3.15: Grandfathering challenge test data from previous studies

## 8.5.6 UV appliance challenge

The validation protocol in the UV Guidance Manual (USEPA 2003d, 2006c) builds on well-established protocols used in Europe and North America: see also DVGW Technical Standard W294, öNORM M5873 (Osterreichisches Normungsinstitut 2001/2003), and NSF/ANSI 55-2002 (NSF and ANSI 2002b) for Class A systems.

A UV disinfection appliance manufacturer typically delivers a UV appliance to a test facility. Test personnel inspect the UV appliance and document features of the design that impact dose delivery and monitoring (eg, appliance dimensions and sensor properties). The UV appliance is installed within a biosimetry test stand with inlet and outlet piping that should result in equal or worse dose delivery than with the appliance installed at the treatment plant site. The UV appliance is operated under various test conditions of flow, UVT, and lamp power. The test condition of UVT is typically obtained using a UV-absorbing compound injected into the flow upstream of the UV appliance. A challenge micro-organism is injected into the flow upstream of the UV appliance. The concentration of viable challenge microorganisms is measured in samples collected at the appliance's inlet and outlet. The results are used to calculate the log inactivation of the challenge microorganism achieved by the UV appliance.

The UV dose-response of the challenge micro-organism present in the inlet sample is measured using a bench-scale device termed a collimated beam apparatus. The UV dose-response curve is used to relate the log inactivation observed through the appliance to a UV dose value termed the Reduction Equivalent Dose (RED). A safety factor is applied to the results to account for any bias and random uncertainty associated with the validation of the UV appliance and the online monitoring approach used to indicate dose delivery both during validation and during operation at the water treatment plant. Lastly, a validation report is prepared that describes the UV appliance tested, the test protocol, the test results, and the inactivation credits that can be assigned to the UV appliance under given conditions of flow, UVT, and lamp output. Refer also to section 8.4.4.3.

Section 5.3 of USEPA (2006) *UV Disinfection Guidance Manual for the Final LT2ESWTR* (UVDGM) allows different test organisms to be used for validation, the choice being dependent on the target pathogen. Table 5.2 in UVDGM shows the delivered UV dose required to inactivate a range of micro-organisms.

Successfully challenging with MS2, for example, means the appliance is validated to deliver a 40 mJ/cm<sup>2</sup> dose which is the same dose specified in DVGW, öNORM and NSF, which means the appliance is validated for bacterial disinfection (and of course protozoal compliance).

Successfully challenging with T1, for example, means the appliance is validated to achieve 3 log inactivation of *Cryptosporidium* and *Giardia* delivering a dose of at least 12 mJ/cm<sup>2</sup>.

The validation certificate must state the conditions, ie, UVT, and in this context, particularly the flow rate. A UV disinfection appliance has now been marketed in New Zealand with validation using **both** MS2 and T1. That particular appliance has been validated to achieve 3 log inactivation of *Cryptosporidium* and *Giardia* at 80 USGPM, but is validated for bacterial disinfection at only 50 USGPM.

So, if this appliance is installed at a water treatment plant that achieves bacterial compliance by dosing with chlorine (say), protozoal compliance can be achieved at a flow up to 80 USGPM. But if the UV appliance is meant to achieve bacterial **and** protozoal compliance, the flow rate cannot exceed 50 USGPM.

The ETV UV Protocol was developed in conjunction with NSF through the ETV Drinking Water Systems (DWS) Center to clarify vague aspects of the USEPA's "Ultraviolet Disinfection Guidance Manual" (USEPA 2011).

WRF (2015) states that recent research shows significant differences between the wavelength responses or action spectra of validation test microbes and regulated pathogens, namely *Cryptosporidium*, *Giardia*, and adenovirus. These differences impact the interpretation of UV validation data used to define UV dose monitoring algorithms and disinfection credit with UV systems using polychromatic MP UV lamps. While the USEPA UV Disinfection Guidance Manual (UVDGM) accounts for these differences, it does not account for the UV transmittance spectrum of the quartz sleeve housing the MP lamp, the UV absorbance spectra of the water passing through the reactor, or the configuration of the lamps within the UV reactor. As such, the UVDGM approach can be overly conservative with many commercial UV systems. The approach is also limited by the quality of the action spectra data in the peer-reviewed literature, which show a high degree of variability due to the methods used, and do not extend over the full germicidal range (from 200 to 300 nm). Understanding the action spectra over the full germicidal range is important for the calculation with many MP UV reactors. Currently UV sensors used with today's commercial MP UV reactors do not monitor UV intensity at wavelengths below 240 nm. In due course these observations will be integrated into validation procedures. Research is needed though; for example, although MS2 is accepted as a good surrogate for *Cryptosporidium*, that statement is only true for wavelengths above 240 nm. Below 240 nm, published data indicates that validation using MS2 phage is overstating *Cryptosporidium* dose by as much as 50 percent.

## 8.5.7 General

USEPA (2005a) notes: although the primary focus of challenge testing as required under the LT2ESTWR is demonstration of *Cryptosporidium* removal (or inactivation), the general framework for challenge testing developed in the membrane filtration guidance manual may be adapted for use in establishing removal efficiencies for other microbial pathogens of concern, including bacteria, viruses, and other protozoa such as *Giardia*.

# 8.6 Sampling and testing for protozoa and substitute compliance tests

## 8.6.1 *Giardia* and *Cryptosporidium* testing

The log credits derived in the LT2ESWTR (USEPA 2006a) for the various treatment processes used for protozoa removal or inactivation were based on the use of Methods 1622 and 1623 (USEPA 2001b and 2001c). Method 1623 was also used when categorising raw waters according to the number of *Cryptosporidium* present. The latest version of Method 1623 appears in USEPA (2005b).

The USEPA developed Method 1622 (detects *Cryptosporidium*) and 1623 (detects *Cryptosporidium* and *Giardia*) to achieve higher recovery rates and lower inter- and intra-laboratory variability than previous methods. These methods incorporate improvements in the concentration, separation, staining, and microscope examination procedures.

The performance of these methods was tested through single-laboratory studies and validated through round robin studies. To assess method recovery, matrix spike samples were analysed on five sampling events for each plant. The protozoa laboratory spiked the additional sample with a known quantity of *Cryptosporidium* oocysts and *Giardia* cysts (the quantity was unknown to the laboratory performing the analysis) and filtered and analysed both samples using Methods 1622/23. Recovery averaged 43 percent for *Cryptosporidium* with a relative standard deviation of 47 percent (Connell et al 2000).

Although Methods 1622 and 1623 have several advantages over the earlier method, they also have some of the same limitations. These methods do not determine whether a cyst or oocyst is viable or infectious, and both methods require a skilled microscopist and several hours of sample preparation and analyses.

The minimum sample size for raw water categorisation purposes is 10 litres. The USEPA has prepared draft guidance for sampling and testing (USEPA 2006b and 2006d). The final version appears as USEPA (2006b).



Laboratories must meet the quality control requirements in Methods 1622 and 1623. For compliance testing, laboratories need to be accredited by IANZ.

Because it is impractical to use *Cryptosporidium* or *Giardia* testing of water treatment plants to demonstrate compliance with the protozoal MAV in the DWSNZ, various operational performance requirements are used instead. These include turbidity (or particle counting), direct integrity testing, indirect integrity testing, pressure differential, UV intensity, and C.t values for ozone and chlorine dioxide disinfection.

## 8.6.2 Turbidity measurement

The water industry has used turbidity as a marker of consistency and quality of water effluent from water treatment plant filters. In the DWSNZ, turbidity monitoring is an operational requirement for bacterial and protozoal compliance. An increase in turbidity measurement is perceived as deterioration in the performance of the treatment process, with a potential for the breakthrough of pathogens from the filters, or a reduction in disinfection efficacy. Conversely, as a generalisation, the lower the turbidity, the lower the pathogen risk.

Nephelometry is the only method of determination to be used for turbidity measurements. It is a method-defined parameter that can detect the presence of a wide variety of particles in water (eg, clay, silt, mineral particles, organic and inorganic matter, and micro-organisms).

Turbidity is not a direct measurement of suspended particles in water. Turbidimeters detect the intensity of light scattered from particles at one or more angles to an incident beam of light. The angular distribution of scattered light depends on a number of conditions, including the wavelength of the incident light, as well as particle size, shape, opacity and composition. It is difficult to correlate the turbidity with the number or concentration of particles in suspension. The results are expressed in nephelometric turbidity units (NTU). Other methods of measurement use different principles of measurement and yield results in units that cannot be converted to NTU. Some early models used absorptiometry so also measured some of the dissolved organic matter.

See datasheets for turbidity and suspended solids.

Some ISO 7027 instruments read turbidity as formazin nephelometric units (FNU) which are equivalent to NTU although derived from different measurement techniques. Note that DWI (2014) describes two turbidity units:

- 1 FTU (Formazine Turbidity Unit) is 1/400th of the turbidity of a standard suspension prepared under the correct standard conditions
- 1 NTU (Nephelometric Turbidity Unit) is taken to mean turbidity measured using a 90° scatter instrument calibrated using formazine prepared under correct standard conditions.

Small particles less than one-10th of the light wavelength will scatter light uniformly in both forward and backward directions. As the particle size approaches and exceeds the wavelength of the incident light, more light is transmitted in the forward direction. Because of this intensity pattern, the angle at which the light is measured is a critical factor; the current international standards (eg, USEPA Method 180.1 and ISO 7027) have determined the most appropriate angle to be 90 degrees.

Turbidimeters with scattered light detectors at 90° to the incident beam are called nephelometers. Hach instruments satisfy USEPA Method 180.1. The Great Lakes Instrument model Accu4 Turbidity system operates in accordance with GLI Method 2 and ISO 7027 (1999).

Two types of online and bench turbidimeters may have the capability to measure low levels of turbidity: conventional, and laser turbidimeters. Conventional turbidimeters typically use a tungsten lamp or other light-emitting diode (LED) as a light source (some use infrared light); laser turbidimeters use a laser light source.

Manufacturer specifications indicate that laser turbidimeters may have increased sensitivity in excess of two orders of magnitude over conventional turbidimeters. There are cases where laser turbidimeters are measuring drinking-water quite successfully at less than 0.05 NTU; conventional turbidimeters become increasingly difficult to maintain reliability below 0.20 NTU. Some laser turbidimeters measure in mNTU (milliNTU). Laser turbidimetry is covered by USEPA Method 10133. The Hach FilterTrak 660 sc Laser Nephelometer claims to have the ability to detect a 0.3 mNTU or 0.0003 NTU change in turbidity with a repeatability of <1% or ± 0.002 NTU.

Since most microfiltration and ultrafiltration systems produce filtrate water consistently in the range of 0.03 to 0.07 NTU as measured by conventional turbidimeters, laser turbidimeters or particle counters (see section 8.2.2.2) may be better suited for monitoring membrane filtrate.

When the 2005/08 DWSNZ were published there were four USEPA-approved analytical methods for the measurement of turbidity. These are as follows:

- 1) USEPA Method 180.1, Determination of Turbidity by Nephelometry (USEPA 1993a) uses nephelometric technology, which measures light scatter at a 90° angle from the initial light path. The photodetector must be centred at that angle, and cannot extend more than 30° from that centre point. To minimise differences in light scatter measurements, the method states that the incident and scattered light cannot travel more than 10 cm from the light source to the photodetector. The light source used in each turbidimeter be a tungsten lamp with a colour temperature between 2,000 K and 3,000 K. This means that the tungsten output is polychromatic, or broadband in spectrum. When the light reaches the photodetector, the spectral peak response should be between 400–600 nm.

- 2) Great Lakes Instrument Method 2 (called GLI 2 or USEPA Method 180.2) (USEPA 1993b) doubles the number of photodiodes and photodetectors used in the average turbidity instrument. It also doubles the number of measurements taken. As such, this design is also known as a modulated four-beam turbidimeter. By using two measurements, two light sources, and two detectors, this method can compare results between the detectors and cancel out errors. This method requires 860 nm LEDs, which allows for colour compensation, much as the single beam ISO 7027 method does. The LEDs alternate light pulses every half second. The photodetectors take simultaneous readings, providing an "active signal" and "reference signal".
- 3) Hach FilterTrak Method 10133 (also called USEPA Method 10133) (USEPA 2002) is also based on nephelometric technology (90°), but uses a laser light source as opposed to a tungsten lamp or infrared LED. It is not recommended for use when turbidity levels exceed 5.0 NTU. The laser diode must emit red light, with a wavelength between 630 nm and 690 nm. As with the EPA Method 180.1 and the ISO 7027 method, the total distance that the light beam travels cannot exceed 10 cm. The detector must be set at 90° from the incident light path, and must be connected to a photomultiplier tube via a fibre-optic cable. It is designed for on-line, or process monitoring.
- 4) Standard Method 2130B, Turbidity – Nephelometric Method, American Public Health Association (APHA 2012) is nearly identical to USEPA Method 180.1. 2130B clearly defines the basis of nephelometric technology, as well as the methods for creating a proper primary calibration standard. Established two years apart, (1993 and 1995), both methods maintain the same physical requirements for compliant turbidity meters. According to Standard Methods, the only acceptable primary standard is formazin, made by the user, following specific instructions. This includes the specified filter size of 0.1 µm if the prepared formazin needs to be diluted (Method 180.1 allows a filter size of 0.45 µm). However, method 2130B states that user-prepared formazin should be a last resort due to the use of carcinogenic compounds in its preparation. Instead, Standard Methods strongly recommends using a commercial or manufacturer-supplied calibration solution, whether made from a commercial stock suspension of formazin, styrene-divinylbenzene copolymers, latex suspensions or other polymer suspensions, all considered secondary standards. The USEPA Method 180.1, on the other hand, considers user-prepared formazin, commercial formazin and AMCO-AEPA-1 styrene-divinylbenzene polymer standards all to be primary standards. Only manufacturer-supplied latex suspensions and metal oxide/polymer gel suspensions are called secondary standards by this method.

The DWSNZ allow turbidimeters that comply with any other system approved by the USEPA for drinking-water compliance monitoring. USEPA (2009) approved four alternate test procedures (ATP) for drinking water that produce comparative results relative to EPA Method 180.1, Fondriest Environmental Inc (2014); the publication includes excellent discussion on many aspects of turbidity and its measurement. The four methods are:

- 1) **Mitchell Method M5271** is similar to Hach Method 10133 as it uses laser nephelometry to determine turbidity in an online or process monitoring instrument. The laser light source must emit a wavelength of  $650 \pm 30$  nm. This is a shift of  $10^\circ$  from the Hach method, which uses a laser diode at 630-690 nm. It is also very similar to EPA Method 180.1, as it limits light travel to 10 cm and allows the photodetector to extend  $\pm 30^\circ$  from the  $90^\circ$  centre. This method requires a bubble trap and anti-fog windows. To be compliant, the turbidity sensor must be able to withstand up to 30 psig of pressure. The method is applicable in the range from 0–40 NTU.
- 2) **Mitchell Method M5331** uses an LED as a light source. The LED must emit a wavelength of  $525 \pm 15$  nm. All other requirements match Mitchell Method 5271.
- 3) **Orion Method AQ4500** was developed by Thermo Scientific and is based on their Thermo Orion AQUAfast Turbidimeter Model AQ4500. This method follows all the requirements of EPA Method 180.1 except for the specified light source. Instead of using a polychromatic tungsten lamp as a light source, the AQ4500 uses a “white” LED. To achieve a broad band output with a typically narrow band LED, this method uses a phosphorus coated blue LED. This expands the spectral output from the blue 450 nm wavelength to a wide spectrum response similar to a tungsten source/cadmium sulphide detector combination. Use of an LED light source allows for rapid pulsing operation. Pulsing the light permits synchronous detection. This means that any stray light or electronic-induced errors can be reduced and nearly cancelled out. This method also reduces errors due to colour absorption by using two photo detectors.
- 4) **AMI Turbiwell** is unique in that it is an EPA-approved turbidity monitoring method for a non-contact turbidimeter. As a non-contact, or surface scatter, nephelometer, the AMI Turbiwell is intended for continuous monitoring, like other process or on-line monitoring instruments. Until 2009, no surface-scatter design was approved by the USEPA. This design requires that the light source be an LED with a spectral response between 400 and 600 nm. The incident light beam should be angled to reach the water’s surface at a  $45^\circ$  angle,  $\pm 5^\circ$ . A beam splitter should be used to deflect a small portion of this light beam before it hits the water. This deflected beam is used as a reference signal to monitoring light intensity. The primary photodetector is set at a right angle to the light source, and should have a peak spectral response between 400–600 nm. An algorithm determines turbidity levels based on the light intensity of the scattered and reference signals.

Guidance on the installation, standardisation, operation, and maintenance of online turbidimeters is usually provided by the manufacturer but is also provided in the *Guidance Manual for Compliance with the Interim Enhanced Surface Water Treatment Rule: Turbidity Provisions* (USEPA 1999). Appendix 2 of DWSNZ covers some general compliance requirements for continuous monitoring. Appendix A2.3 of the DWSNZ discusses standardisation and verification of online, bench top and portable turbidimeters.

The ETV Advanced Monitoring Systems Center (USEPA 2012) developed a protocol for implementing a verification test for the performance of online turbidimeters. In order for turbidimeters to be used for compliance monitoring in the US, the technology and method must gain acceptance under the USEPA Alternate Test Procedure (ATP) program (<http://water.epa.gov/scitech/methods/cwa/atp/>). This acceptance is based on the performance of the vendor's turbidimeter against an EPA Method 180.1 compliant turbidimeter. For these applications, the turbidimeters must be accurate ( $\pm 10\%$ ) relative to the reference measurement (in this case, a Method 180.1 compliant turbidimeter) used for reporting, and must be precise ( $\pm 10\%$ ). Since these technologies are intended for use online for compliance purposes, they should be reliable and exhibit stability to avoid frequent or unscheduled offline maintenance. The verification test is designed to address and quantify these performance characteristics.

Because the turbidity reading will depend in some way on the design of the turbidimeter ASTM D7315 is very specific about reporting procedures – units must indicate exactly which instrument design is being used.

### Light sources

Tungsten lamps fitted with monochromators and filters, diodes and lasers may be used as sources of monochromatic radiation. However, some older apparatus fitted with tungsten lamps, but without monochromators or filters, are still in use (polychromatic sources) and, while the reproducibility of such apparatus may be less than that of apparatus providing monochromatic radiation, they can be used for the daily control and monitoring of turbidity at waterworks and treatment plants. Results cannot, however, be compared when using different apparatus. Lamps used by ISO instruments have light requirements with incident light outputs of 860 nm and a spectral bandwidth of less than 60 nm. The detector and filter system, if used, that conform to USEPA 180.1 measure between 400 and 600 nm.

Tungsten light sources are generally more sensitive to small particles but sample colour interferes, particularly as the turbidity increases; LED light sources are not as sensitive to small particles but are not likely to have colour interferences. However, colour in good quality drinking-water should have a minimal effect on turbidity measurements. Some laboratory and portable turbidimeters using the tungsten filament lamp employ a ratio optical system to compensate for colour.

### Bubble trap

Air bubbles will measure as turbidity. This can be a problem if the water being tested is drawn from a point near turbulence, and after backwashing. Samples tested manually will produce air bubbles if the water is near dissolved oxygen saturation and the temperature has increased at the time of testing.

Not all process (online) turbidimeters use bubble traps. Some use baffles or positive pressure to reduce bubbles. Some use vacuum. Bubble traps have varied efficiencies depending on the installation and the instrument. Bubble traps should not be added to some models; check with the manufacturer. Generally, a slow flow rate will assist in better bubble removal, and hence more accurate results. However, slow flow rates are not always ideal, ie, particles may settle out. Conversely, high flow rates may scour build-up off pipe surfaces.

With reference to the membrane filtration process (in particular), turbidimeters are subject to air entrainment error. Any air bubbles introduced into the system during production, backwashing, chemical cleaning, or integrity testing may artificially increase the turbidity reading. After backwash or chemical cleaning (particularly if air is used in the process), turbidity measurements may not be representative of filtrate quality until any entrained air is purged from the system. This purge time will vary between different filtration systems and their respective operations. Bubble traps may be used with conventional and laser turbidimeters to minimise or eliminate this error.

### Sampling (ETV 2002)

The method for collecting grab samples shall consist of running a slow, steady stream from the sample tap, triple-rinsing a dedicated sample beaker in this stream, allowing the sample to flow down the side of the beaker to minimise bubble entrainment, double-rinsing the sample vial with the sample, carefully pouring from the beaker down the side of the sample vial, wiping the sample vial clean, inserting the sample vial into the turbidimeter, and recording the measured turbidity. In the case of cold water samples that cause the vial to fog preventing accurate readings, the vial shall be allowed to warm up by partial submersion in a warm water bath for approximately 30 seconds.

It is possible to have extremely good correlation between online and laboratory turbidimeters. Correct technique is extremely important with both standardisation and sample measurement. Sample cells are a well-known source of error. Scratches, stray light, dirt, fingerprints, orientation, etc, contribute to these errors.

### Standardisation and verification

Standardisation of turbidimeters (sometimes called calibration) comprises three components:

- a) standardisation (or primary standardisation)
- b) verification (or secondary or check standardisation)
- c) zero calibration (or zero check).

### Primary standardisation

Bench top turbidimeters may be used for compliance testing of manual samples in laboratories recognised by the Ministry of Health. The turbidimeter must be standardised and used according to the conditions of their accreditation. Otherwise standardisation of bench top and portable instruments should be performed to manufacturer's recommendations. With the availability of stabilised formazin standards (StablCal) any errors from making or diluting standards have been reduced significantly. However, care of the cells still must be observed rigidly.

Appendix A2.3 of the DWSNZ states that standardisation of bench top turbidimeters used as field instruments, and portable and online turbidimeters must be undertaken by personnel approved to do so by the DWA, and in accordance with the instrument manufacturer's specified procedures and frequency or three-monthly whichever is more frequent. Standardisation must be performed using traceable standards such as StablCal (Hach) or PrimeTime (HF Scientific) (or other MoH-approved stabilised formazin preparation); or AMCO-AEPA-1 styrene divinylbenzene microsphere suspensions (Advanced Polymer Systems). Alternatively, user-diluted formazin preparations may be used provided:

- 1) the calibration point is 20 NTU or greater
- 2) the 4000 NTU formazin preparation is obtained from a quality certified manufacturer
- 3) the dilution is done immediately prior to use for calibration.

Re field testing, the quality assurance procedures associated with standardisation and verification must be approved by the DWA.

The StablCal, PrimeTime (both stabilised formazin preparations) and AMCO-AEPA-1 standards can only be used before their expiry dates, where applicable.

The user-diluted standard must be made from a stock 4000 NTU formazin standard diluted with low turbidity water. 'Turbidity-free' water should be prepared as specified by the instrument manufacturer, or by APHA (2005), or in the method of determination being followed. Formazin is the only standard that can be prepared reproducibly from traceable raw materials. The particle size distribution of formazin is 0.01 to 10 µm, similar to the particle size distribution found in most natural water samples.

Only the use of formazin, stabilised formazin, and styrene divinylbenzene (SDVB) are accepted for reporting by the USEPA. SDVB standards are microscopic beads with narrow size distribution. However, due to the mono-dispersed nature of the size distribution, incident light may over-scatter into the forward direction and result in inaccurate calibrations. Therefore, SDVB standards are instrument-specific, and some manufacturers may recommend not using them.

### Why standardise at 20 NTU? (ie, when using formazin suspensions)

To make an accurate low level turbidity standard is extremely difficult and fraught with errors. The relationship between nephelometric detector response to turbidity is highly linear in the range of 0 to 40 NTU, if no colour exists or is very low. This linearity requires only two points for standardising over this range. Criteria are:

- 20 NTU is the midpoint
- the standard is prepared easily with a high degree of accuracy
- accuracy is maintained from the standard to the lowest measurement levels because the relationship between nephelometric light scatter and turbidity is linear
- errors due to stray light are negligible at 20 NTU and do not affect the level of accuracy of the standard curve.

## Verification of process instruments

Verification that the performance of portable instruments has not changed since standardisation must be carried out daily, or each time the instrument is switched on.

Verification of online turbidimeters must be carried out at least weekly using the manufacturer's secondary or check standard. If the instrument reading is outside the limits specified for the check standard, then that instrument must be restandardised using the standardisation method; or replaced. Table 8.8 summarises some methods for the standardisation and verification of turbidimeters.

Check standards have been developed by manufacturers to duplicate light scatter. The devices are instrument specific and are usually traced back to formazin. Their use for standardisation is not acceptable for compliance reporting by the USEPA (or in the DWSNZ), ie, must not be used for standardisation. However, they can be used for verification, ie, QA purposes.

**Table 8.8: Summary of some methods for standardisation and verification of turbidimeters**

| Standard                                      | Type                            | Particle size   | Comments  |
|---|---------------------------------|-----------------|---|
| User prepared formazin 4000 NTU               | Standardisation                 | 0.01 to 10.0 µm | May be difficult to provide traceability. Lower dilution limit is 2 NTU.  |
| Commercially prepared formazin 4000 NTU       | Standardisation                 | 0.01 to 10.0 µm | Test performed by manufacturer to ensure complete reaction and therefore able to provide traceability. Lower dilution limit is 2 NTU. |
| Stabilised formazin – eg, StablCal, PrimeTime | Standardisation or verification | 0.01 to 10.0 µm | Traceable. Standards ready to use down to 0.10 NTU.   |
| SDVB  | Standardisation or verification | 0.1 to 1 µm     | Not recommended for standardisation. Can be used for verification below 1.0 NTU. Instrument specific.                                 |
| Optomechanical check standard                 | Verification                    | NA              | Instrument specific standards. Verification down to 0.5 NTU.  |

These devices, along with other check standards (eg, latex or gel) need to be referenced back to a formazin standard on a regular basis. It is recommended to standardise each turbidimeter, then to insert the check standard and record the value for the specific turbidimeter. Check standards need to be reassigned new values after each comparison with the standard because they may have become scratched; also the lamp of the optical system in the instrument may have changed, eg, due to dust or lamp aging.

Verification that the performance of the instrument has not changed since standardising must be carried out on

- online turbidimeters: weekly, or after any interruption to continuous reading
- manual turbidimeters: daily, or each time it is switched on.

If the value displayed is outside the specified limits (commonly  $\pm 10$  percent) of the reference value previously established from standardisation, eg, outside by more than 1.98 NTU of a reference value of 19.8 NTU, then a new primary calibration is needed.



## Verification of laboratory and field instruments

If a check standard is not available, the instrument should be verified against a laboratory instrument that has been standardised recently. This will involve checking the range of turbidities that the samples will fall into. This is not the preferred method because APHA (2012, Method 2130) says to report to the nearest 0.05 NTU if the turbidity is in the 0–1 NTU range; this is not very practical, particularly if the water being monitored has a turbidity less than 0.20 NTU. However, ISO 7027 allows readings less than 0.99 NTU to be reported to the nearest 0.01 NTU, which is more appropriate for the newer instruments.

## Zero check

Some instruments automatically 'fix' the zero point. This is sometimes done by turning off the incident light. Others require a 'turbidity-free' blank. Although it is impossible to produce 'turbidity-free' water, it is possible to produce a blank with a turbidity of about 0.02 NTU; when standardising with 20/40 NTU formazin this small error at the zero point is insignificant. DWI (2014) states that pure water scatters light equivalent to a turbidity of 0.008 NTU at 860 nm, the standard ISO 7027 operating wavelength, or 0.02 NTU at 550 nm, the approximate centre wavelength of a white light source. Since the objective is to measure the particulates in the sample, a turbidimeter zero should be set to the scattered light of particle-free water rather than zero scattered light.

## Monitoring and reporting

The DWSNZ stipulate that for online monitors:

- the signal averaging time is to be one minute or less
- where discrete readings are recorded, the interval between readings is not to be more than one minute.

The previous paragraph discusses rounding of readings from manual instruments. Online instruments will report the readings 'as is' where there is a maximum turbidity that must never be exceeded. Where compliance is related to the percent of time, turbidimeters will report the percent of time the turbidity is non-complying, rather than absolute values.

Ensure that the analyser 4–20 mA output scan matches the PLC/SCADA digital output. Check that the SCADA display mimics the instrument display. See Chapter 17: Monitoring, section 17.4.4 for a discussion on reporting results and storing data, and section 17.6 for how to compare test results against a MAV or operational requirement.

## Turbidity measurement

With practice, it is not unrealistic to expect reasonably good correlation between most good laboratory turbidimeters and process turbidimeters if based on the same primary standard. When measuring low-level turbidity in the laboratory, rigorous care must be taken to eliminate errors.

DWI (2014) states that there has long been a perception that online turbidity readings on final water are lower than the laboratory readings, and this is true for 10 out of 13 of the datasets analysed for this project. There are numerous possible reasons for this associated with the laboratory method, the online method or differences between them. Possible reasons are given (see DWI's pp 34–36, 44–45).

Sample cells are the biggest source of error in turbidity measurements. Cells should be matched or indexed, clean, and scratch free. The appropriate silicon oil should be applied to mask any scratches that the eye cannot see.

Bubbles can be removed by applying a vacuum to the cell. A syringe with a rubber bung is an easy solution to this.

To avoid any problems with condensation on the cell, allow the sample to reach room temperature, this will also assist with bubbles dissipating.

### Measurement of low level turbidity

An important aspect of awarding additional protozoa removal credits for lower finished water turbidity is the performance of turbidimeters when measuring turbidity below 0.3 NTU or even below 0.10 NTU. The following paragraphs from the proposed LT2ESWTR (USEPA 2003a) summarise results from several studies that evaluated low level measurement of turbidity by different online and bench top instruments. The USEPA believes that results from these studies indicate that currently available turbidity monitoring equipment is capable of reliably assessing turbidity at levels below 0.10 NTU, provided the instruments are approved for compliance monitoring, are well-calibrated and well-maintained.

A performance evaluation (USEPA 1998), was carried out to address concern regarding the ability to reliably measure low turbidity levels. The study involved distribution of different types of laboratory-prepared standard solutions with reported turbidity values of 0.150 NTU or 0.160 NTU. The data indicated a positive bias for all instruments when compared against a reported true value. Online instruments in this study had a larger positive bias and higher standard deviation (RSD approximately 50 percent). The positive bias is consistent with previous studies (USEPA 1998) and suggests that error in turbidimeter readings may be generally conservative (ie, water supplies will operate at lower than required filtered water turbidity levels).

Letterman et al (2001) evaluated the effect of turbidimeter design and calibration methods on inter-instrument performance, comparing bench top with online instruments and instruments within each of those categories from different manufacturers. Reported filtered water turbidity values ranged from 0.05 to 1.0 NTU. The results were consistent with those of the earlier study, specifically the positive bias of online instruments. Letterman et al found generally poor agreement among different online instruments and between bench-top and online instruments. The authors observed that results were independent of the calibration method, though certain experiments suggested that analyst experience might have had some effect on turbidity readings from bench-top instruments.

Sadar (1999) conducted an intra-instrument study of low level turbidity measurements among instruments from the same manufacturer. This study was performed under well-controlled laboratory conditions. Intra-instrument variation among different models, and between bench top and online instruments, occurred but at significantly lower levels than the Letterman et al inter-instrument study. Newer instruments also tended to read lower than older instruments, which the author attributed to a reduction in stray light and lower sensitivities in the newer instruments. Sadar also found a generally positive bias when comparing online with bench-top and when comparing all instruments with a prepared standard.

The American Society for Testing and Materials (ASTM) has issued standard test methods for measurement of turbidity below 5 NTU by online (ASTM 2001) and static (ASTM 2003) instrument modes. These standards are not used very often in New Zealand. The methods specify that the instrument should permit detection of turbidity differences of 0.01 NTU or less in waters having turbidities of less than 1.00 NTU (ASTM 2001) and 5.0 NTU (ASTM 2003), respectively. Inter-laboratory study data included with the method for a known turbidity standard of 0.122 NTU show an analyst relative deviation of 7.5 percent and a laboratory relative deviation of 16 percent (ASTM 2003).

In summary, the data collected in these studies indicate that currently available monitoring equipment can reliably measure turbidity at levels of 0.10 NTU and lower. This requires rigorous standardisation and verification procedures, as well as diligent maintenance of turbidity monitoring equipment (Burlingame 1998, Sadar 1999). Systems that pursue additional protozoal credit for lower finished water turbidity must develop the procedures necessary to ensure accurate and reliable measurement of turbidity at levels of 0.10 NTU and less.

### 8.6.3 Particle counting and particle monitoring

A simple conversion factor relating particle counting and turbidity measurements is not possible because the two techniques differ fundamentally in terms of discernment. Particle counting measures two characteristics of particulates: numbers of particles and particle size. Samples with identical clarity can be distinguished on the basis of these two features; one sample may contain many small particles, whereas another may contain few large particles. Turbidity, on the other hand, cannot distinguish between two samples of identical clarity and different particulate composition.

Online particle counters use a laser-based light scattering technique to count particles and group them according to size.

Particle monitors also operate on the principle of light obstruction; however, rather than counting particles and grouping them by size, particle monitors measure particulate water quality on a dimensionless scale relative to an established baseline. The instrument measures fluctuations in intensity of a narrow light beam that is transmitted through the sample. The monitor does not count particle sizes, but provides an index (ranging from 0 to 9999) of the water quality. No calibration is required for this instrument since the output is a relative measurement of water quality. The potential advantages of this monitor are its low cost and ease of operation compared with particle counters, but little information has been published regarding the use of particle monitors in potable water treatment applications.

Particle counters convey information about particle size. Any significant increase in the number of particles exceeding 3 micrometres may indicate that a breach may have occurred allowing the passage of *Cryptosporidium* oocysts. Any particle counters that are used for the purpose of filtrate monitoring to satisfy the continuous indirect integrity monitoring requirement should be calibrated to detect particles in the size range of *Cryptosporidium* oocysts (ie, 3 to 8 micrometres).

Although Adham et al (1995) determined that particle counting was the most sensitive of the three common methods of continuous indirect integrity monitoring (ie, conventional turbidity monitoring, particle counting, and particle monitoring), particle counting instruments have a number of well-established operational problems that potentially can distort both the accuracy and precision of their measurements.

Either particle counting or particle monitoring may be used for compliance with the continuous indirect integrity monitoring requirements of the DWSNZ, ie, for membrane, cartridge or bag filtration. They can also substitute for monitoring the turbidity of water leaving a filter where a coagulation process is used. Due to the range of instruments, and the small amount of use of the technique in New Zealand, details have not been prescribed in the DWSNZ. Water suppliers wishing to use particle counting need to submit their monitoring plan to the DWA for approval.

Some relevant references on the use of particle counters in water treatment applications that may serve as a useful source of additional information are:

- *Fundamentals of Drinking Water Particle Counting* (AWWARF 2000)
- *Particle Count Method Development for Concentration Standards and Sample Stabilisation* (American Water Works Association Research Foundation, AWWARF 2000).

The former publication was prepared by Erica Hargesheimer, and is available from NZWWA. It is very thorough and covers virtually everything that is needed for deciding whether to use particle counting, and how to use it, once installed.

Advantages of particle counting and particle monitoring are generally similar, and include the following:

- more sensitive to smaller integrity breaches than conventional turbidimeters
- widely used in surface water treatment plants (particle counters)
- absolute (as opposed to relative) measure of water quality (particle counters)
- ability to yield information regarding test resolution (particle counters).

Limitations of particle counting and particle monitoring include:

- imprecision between instruments at low particulate concentrations
- susceptible to air entrainment error
- susceptible to coincidence and clogging error at higher particle concentrations
- more expensive instrumentation (particle counters) than conventional turbidimeters
- only relative measure of water quality (particle monitors)
- more operation and maintenance support needed than conventional turbidimeters.

Online particle sensors must have capabilities for measurement of particles as small as 2 microns and have a coincidence error of less than 10 percent. The resolution should be at least 10 percent at 10 microns. Flow control shall be within 5 percent of the designed rate.

The particle counter must be delivered to the water supplier pre-standardised, and subsequent standardisations shall be performed at least every 18 months. The particle counter manufacturer or an independent third party shall provide data and methods that the online particle sensors meet these criteria.

APHA (2005) includes Method 2560 on the use of particle counters and size distribution, with a section on quality control.

Two time intervals are important with online particle counters:

- the count time or interval, which is the time the instrument takes to analyse a sample
- the count frequency, which is the time between samples.

Count times are typically 30–60 seconds, and count frequencies are typically 5–6 minutes (AWWARF 2000a).

There are many variables related to particle counters. Ideally the following should be satisfied:

- the particle counter is an optical particle counter
- standardisation to be done in accordance with manufacturer's specification but not less than every 18 months
- resolution to be 10 percent at 10 microns or better
- sensitivity to be 2 microns
- range from 2 to 400 microns
- flow cell size must be not less than 700 microns
- type of flow cell must be of the volumetric type
- coincidence to be 10 percent at 16,000 particles per mL
- must be operated with an appropriate quality assurance programme
- minimum two channel (most affordable for small systems)
- flow control shall be at manufacturer's specified flow rate  $\pm 5$  percent or better
- plumbed to minimise interference due to air bubbles
- must be properly maintained (cleaned) to manufacturer's specification
- must replace with approved tubing annually.

## 8.6.4 Direct integrity test (membrane filtration)

Because it is impractical to use *Cryptosporidium* testing of membrane filtration plants to demonstrate compliance with the protozoal MAV in the DWSNZ, a performance requirement is used instead. Direct integrity testing is described in the Membrane Filtration Guidance Manual (USEPA 2003c, 2005a), in Chapter 4 (50 pages). However, the supplier or manufacturer of the plant, in accordance with the conditions of their validation, will dictate the test to be used by any membrane filtration plant owner.

The following has been taken from the introduction to direct integrity testing in the Membrane Filtration Guidance Manual.

In order for a membrane process to be an effective barrier against pathogens and other particulate matter, the filtration system must be free of any leaks or defects resulting in an integrity breach. Thus, it is critical that operators are able to demonstrate the integrity of this barrier on an ongoing basis during system operation. Direct integrity testing represents the most accurate means of assessing the integrity of a membrane filtration system that is currently available.

A direct integrity test is defined as a physical test applied to a membrane unit in order to identify and isolate integrity breaches. The removal efficiency of a membrane filtration process must be verified routinely during operation using direct integrity testing. This must be applied to the physical elements of the entire unit, including membranes, seals, potting material, associated valves and piping, and all other components which could result in contamination of the filtrate under compromised conditions.

There are two general classes of direct integrity tests commonly used in membrane filtration facilities: pressure-based tests and marker-based tests. The pressure-based tests are based on bubble point theory and involve applying a pressure or vacuum to one side of a membrane barrier and monitoring for parameters such as pressure loss or the displacement of air or water in order to establish whether an integrity breach is present.

The various pressure-based tests include the pressure- and vacuum-decay tests, the diffusive airflow test, and the water displacement test.

Marker-based tests use either a spiked particulate or molecular marker to verify membrane integrity by directly assessing removal of the marker, similar to a challenge test.

The direct integrity test used must meet the specified performance criteria for resolution, sensitivity, and frequency. Thus, a water supply may use an appropriate pressure- or marker-based test or any other method that both meets the performance criteria and is approved by the state. The performance criteria for direct integrity tests are summarised as follows:

- **resolution:** the direct integrity test must be responsive to an integrity breach of the order of 3 micrometres or less
- **sensitivity:** the direct integrity test must be able to verify a log removal equal to or greater than the removal credit awarded to the membrane filtration
- **frequency:** a direct integrity test must be conducted on each membrane unit at a frequency of no less than once every 24 hours of operation.

In addition to the performance criteria, the rule also requires the establishment of a control limit for the direct integrity test that is indicative of an integral membrane unit capable of achieving the removal credit awarded. If the results of the direct integrity test exceed this limit, the rule requires that the affected membrane unit be taken offline for diagnostic testing and repair.

See Chapter 14: Filtration Processes, section 14.4.5 for a discussion on some operational aspects of direct integrity testing.

## 8.6.5 Indirect integrity testing (continuous)

Used for membrane, bag and cartridge filtration. Note that bag and cartridge filtration does not currently undergo direct integrity testing for compliance with DWSNZ.

The various indirect integrity monitoring methods are not physical tests applied specifically to a filter, but involve monitoring some aspect of filtrate quality as a surrogate measure of integrity. These are discussed in the 17 pages of Chapter 5 of the Membrane Filtration Guidance Manual (USEPA 2003c, 2005a). The information therein also applies to bag and cartridge filtration.

Most direct integrity tests require the membranes to be taken offline, so direct tests are limited to periodic application. A failed direct integrity test indicates that an integrity breach occurred at some time between the most recent direct test in which integrity has been verified and the failed test, but indicates nothing about integrity over the period between direct test applications. Currently, continuous direct integrity monitoring techniques are not available.

Continuous indirect integrity testing is defined as monitoring some aspect or component of filtrate quality that is indicative of the removal of particulate matter. The DWSNZ specify turbidity monitoring of the filtrate as the default methodology for continuous indirect integrity monitoring.

Turbidity was selected because it is an accepted monitoring technology within the water treatment industry, and it is used as both a relative and an absolute indicator of water quality. However, because particle counting is more sensitive than turbidity monitoring, the DWSNZ contain a provision to allow it as an alternative.

Other surrogate measures of integrity are possible, such as dissolved solids or conductivity for the indirect integrity monitoring requirements for nanofiltration and reverse osmosis.

This chapter of the Membrane Filtration Guidance Manual is divided into the following sections:

- Section 5.2: Turbidity monitoring
- Section 5.3: Particle counting and particle monitoring
- Section 5.4: Other indirect monitoring surrogates
- Section 5.5: Data analysis and reporting.

Note that a non-continuous indirect method (eg, a silt density index (SDI) test) has limited value for integrity monitoring, offering neither the ability to directly test the membranes nor the advantage of online monitoring. As a result, non-continuous indirect methods do not satisfy the indirect integrity monitoring requirements of the LT2ESWTR and are not addressed in this chapter.

## 8.6.6 C.t values for chlorine dioxide and ozone

The C.t value is the residual concentration (C) of disinfectant (mg/L) multiplied by the hydraulic residence time (in t minutes). The origin of the concept is discussed in Chapter 15: Disinfection, section 15.2.1. Refer to Chapter 15: Disinfection, section 15.2.9 for a discussion about contact tanks, mixing conditions and measuring the residence time.

The procedure for measuring the hydraulic residence time (t) is described in Chapter 15: Disinfection, section 15.2.9.

For chlorine dioxide (ClO<sub>2</sub>), this involves continuous measurement of the residual chlorine dioxide (measured as ClO<sub>2</sub>) at a predetermined sample site, somewhere upstream of the first consumer. When used for protozoal compliance, the test method must not include FAC. The time the ClO<sub>2</sub> has been in contact with the water up to that point is calculated. The product of the two must exceed the value in the C.t table for the relevant water temperature. If the contact tank also acts as a storage tank, the contact time must be adjusted for when the tank is not full.

For ozone, this involves continuous measurement of the residual ozone at a point in the ozone contactor that has been validated by challenge testing as being able to achieve the required level of inactivation (log credit) of test organisms.

Chapter 11 of the review draft LT2ESWTR Toolbox Guidance Manual (USEPA 2009) discusses issues related to the measurement of contact time in different types of ozone generators and contactors.

If no tracer study data are available for determining t, the USEPA recommends using the continuous stirred tank reactor (CSTR) approach or the Extended-CSTR approach. The t<sub>10</sub>/t ratios are based on baffle characteristics from hydraulic studies of clearwells and basins.

The guidance manual presents three methods for calculating C.t:

- 1 **t<sub>10</sub>**: calculates C.t through a contactor assuming hydraulic conditions similar to plug flow and can be used with or without tracer study data; t<sub>10</sub> is the time it takes for 90 percent of the water to pass the contactor. Even in well-baffled contactors, the t<sub>10</sub> is most often less than 65 percent of the average hydraulic detention time through the contactor, and generally underestimates the true C.t achieved.
- 2 **CSTR**: calculates log inactivation credit using hydraulic detention time. It is applicable to contactors that experience significant back mixing or when no tracer study data are available.
- 3 **Extended CSTR**: a combination of the CSTR and segmented flow analysis approaches. It uses the hydraulic detention time for the contact time and incorporates the ozone decay rate to calculate concentration. It is not applied to chambers into which ozone is introduced.



These methods differ in the level of effort associated with them and, in general, the ozone dose required to achieve a given level of inactivation. Selecting the appropriate method(s) to use depends on the configuration of the ozone contactor and amount of process evaluation and monitoring that a water supplier wishes to undertake. Combinations of two or more methods may also be used. For example, contactors with multiple segments may have one or two segments with their C.t calculated using either the  $t_{10}$  or CSTR methods, while the C.t for the remaining segment is calculated using the Extended-CSTR approach. The  $t_{10}$  and CSTR are the simplest methods.

The sample site and collection requirements are described in USEPA (2009).

The ozone contactor will have been rated in validation tests by the manufacturer or supplier for the water being treated, so the flow, ozone concentration at the monitoring point, and the general operating conditions must be maintained at no worse than the conditions that applied in the validation.

The product of the flow and residual must exceed the value in the C.t table for the relevant water temperature and target log credit.

## 8.6.7 UV intensity measurement

UV intensity sensors are photosensitive detectors that measure the UV intensity at a point within the UV reactor. Sensors are used to indicate dose delivery by providing information related to UV intensity at different points in the reactor. The measurement responds to changes in lamp output due to lamp power setting, lamp aging, lamp sleeve aging, and lamp sleeve fouling. Depending on sensor position, UV intensity sensors may also respond to changes in UV absorbance of the water being treated.

The proposed Ultraviolet Disinfection Manual (USEPA 2003d) stated UV appliances with MP lamps should be equipped with one UV intensity sensor per lamp. USEPA (2006c) requires a minimum of one UV sensor per UV reactor; the actual number should be identical to the UV reactor that was, or will be, validated.

UV sensors are photosensitive detectors that measure UV intensity. UV sensors used in drinking-water UV applications, particularly those with MP or other polychromatic lamps, should be germicidal. Germicidal sensors are defined as having the following properties:

- a spectral response (ie, UV intensity measured at various wavelengths) that peaks between 250 and 280 nanometers (nm)
- less than 10 percent of its total measurement is due to light above 300 nm when mounted on the UV reactor and viewing the UV lamps through the water that will be treated.

Section 5.16.3(2) of DWSNZ specify the requirements for calibration of UV intensity sensors. Further information is included in section 8.4.4.3 (this chapter). Annex A and B of ÖNORM (2001) also cover sensor requirements.

## 8.6.8 Pressure differential

There are no generally accepted direct integrity tests for bag and cartridge filtration. The best technique for assessing the efficiency in removing particles the size of protozoa is particle counting; at present this is difficult and expensive. The commonest indirect integrity test, turbidity, is often of little practical value in demonstrating bag and cartridge compliance because:

- often the raw water has a very low turbidity, for example spring water with a turbidity of say 0.4 NTU. So an operational requirement of 0.5 NTU for compliance purposes could be achieved even if the filter is ruptured or being by-passed!
- some raw waters have a high turbidity due to very fine particles, for example due to silica from glacial flour. These particles may be 10–100 times smaller than protozoa, and will mostly pass through bag or cartridge filters, so are not a good indicator of the filter's ability to remove protozoa.

Therefore another operational requirement is needed to show whether the filter is likely to be performing satisfactorily. Experience has shown that monitoring the pressure differential across the filter housing is a good indicator of performance. The gauge readings and electrical signals from differential pressure transmitters can be verified by using a pressure meter. See Chapter 14: Treatment Processes, Filtration, Figure 14.4 for a recommended layout.

Sections 5.12 and 5.13 of DWSNZ specify the pressure differential monitoring requirements.

## 8.6.9 Microscopic particulate analysis

DWSNZ 2000 included microscopic particulate analysis (MPA) as a method for assessing the efficacy of cartridge, bag, diatomaceous earth and slow sand filters in removing protozoa. The test has not been mentioned in subsequent DWSNZ. However, MPA can still be a useful tool, either quantitatively or qualitatively. A good description of its usefulness appears in a paper by Hancock (1999).

The methodology is described in Vasconcelos (1992), Harris et al (1996), Hancock (1999).

Analysing raw and filtered samples allows the log reduction of organisms to be calculated.

Large volumes, say 2000 litres, of sample can be passed through a filter to trap the organisms. This can be arranged various ways, such as monitoring an entire filter run.

## 8.7 Transgressions

### 8.7.1 Response

Refer to Chapter 17: Monitoring, section 17.6 for a discussion on how to compare a test result against a MAV or operational requirement.

In the DWSNZ, Figure 5.1: Response to turbidity transgression in water after treatment, and Figure 5.2: Response to disinfectant (chlorine dioxide, ozone, UV) transgression in drinking-water leaving a treatment plant, clarify at what stage the DWA is to be consulted, and at what stage routine monitoring can be resumed.

The DWSNZ state that well-managed water supplies will have established a control limit for each MAV or operational requirement. Control limits are discussed in Chapter 17: Monitoring. The preventive actions that are to be considered when a control limit is approaching or reached are to be documented in the PHRMP. The purpose of control limits and the preventive actions is to avoid reaching the transgression level of the MAV or operational requirement, thereby reducing the risk of non-compliance.

Table 5.2 (in DWSNZ) lists the protozoal inactivation or removal processes. Operational aspects of each of these are discussed in Chapters 12–15 of the Guidelines, where relevant. These chapters offer water suppliers some guidance relating to preventive and remedial actions that may be appropriate for inclusion in their PHRMPs. However, there are so many different raw water qualities, treatment processes, modes of operation, and staffing arrangements that it is not possible to cover all contingencies in these Guidelines.

Water suppliers' WSPs must also document planned responses to events other than failing to satisfy the criteria in the DWSNZ that will obviously lead to a protozoal transgression or non-compliance. These will tend to be supply-specific but will include matters such as dealing with emergencies such as power cuts, earthquakes and floods, as well as running out of coagulant or disinfectant, failure of the filtration or disinfection system, disinfection demand exceeding the maximum dose rate, labour problems, breach of security, spills of wastewater or other contamination. Apart from the obvious, these situations may be detected during catchment assessments (ie, what affects the source water), sanitary inspections (of the water supply), or bore head protection inspections.

Some general comments may offer helpful advice for when a control limit is reached or when a transgression occurs:

- unusual weather or water temperatures may have caused raw water conditions to change to the extent that the treatment process is no longer effective (includes algal growth)
- upstream activities such as discharges, gravel extraction, or changes in land use may have modified the raw water quality
- the raw water is possibly being extracted from the wrong depth or position

- screening or other pretreatment may need inspection or maintenance
- bore head protection or screening may have failed
- recycled wash water or sludge supernatant may be affecting the treatment process
- new plant may not have been commissioned correctly
- the water demand may be too high for parts of the treatment process to cope
- various components of the treatment process may require more maintenance or replacement
- the flow through the plant may be unbalanced resulting in some components being overloaded
- the dose of a coagulant, polyelectrolyte, diatomaceous earth, disinfectant or UV may be incorrect
- hydraulic operations may cause a surge through filters, which may then discharge particles
- chemical supplies, spares, and other consumables may be purchased or delivered too late
- monitoring equipment may not be standardised correctly, or may be inappropriate
- water storage tanks may have been interfered with, or have cracked/split
- alarm systems, or the response to them, may be inadequate
- there may be insufficient back up to cover unusual events
- staff may need further training
- a standby electricity generator may be needed
- water may need to be diverted to waste briefly.

Further information is available in the Ministry of Health's Water Safety Plan Guides that can be accessed on [www.health.govt.nz/water](http://www.health.govt.nz/water) and clicking on Publications, then on Water Safety Plans, then selecting the relevant Guide. These have been referenced in the treatment chapters.

## 8.7.2 Reporting

Section 1.6.15 of these Guidelines lists the general compliance criteria for records; these originally appeared in the 2005 DWSNZ and 2008 revision.

All compliance monitoring programmes must be documented, giving details of sample sites, sample collection techniques, sample handling or storage, tests to be conducted, methods used, times and dates. Any variations to the programme or procedure should be noted.

Details relating to instrument calibration, maintenance, and replacements should be recorded.

Results from participating in interlaboratory testing programmes should be retained, along with reports of investigations into the cause of any unsatisfactory test results.

Water suppliers will need to consider how to store test results, particularly those generated by online instruments. A lot of information is generated a year! Ideally, online instruments will only report transgressions, or the percent of time (or samples) that comply. Guidance is offered in Chapter 17: Monitoring: section 17.4.4.

## References

- Adham SS, Jacangelo JG, Laine J-M. 1995. Low-pressure membranes: assessing integrity. *J AWWA* 87(3): 62.
- AS/NZS 4348. 1995. *Water Supply – Domestic type water treatment appliances – Performance requirements*.
- AS/NZS 3497. 1998 (updated 2001). *Drinking water treatment units – Plumbing requirements*.
- APHA et al. 2012. *Standard Methods for the Examination of Water and Wastewater* (22<sup>nd</sup> edition). Washington, DC: American Public Health Association, American Water Works Association, and Water Environment Federation.
- ASTM. 2001. *Standard Test Method for Online Measurement of Turbidity below 5 NTU in Water. D-6698-01*. West Conshohocken, PA: American Society for Testing and Materials.
- ASTM. 2003. *Standard Test Method for Determination of Turbidity below 5 NTU in Static Mode. D-6855-03*. West Conshohocken, PA: American Society for Testing and Materials.
- AWWA. 2001. *Self-assessment for treatment plant optimisation*. American Water Works Association, B Lauer (ed), Denver, Colorado.
- AWWARF. 2000a. *Fundamentals of Drinking Water Particle Counting*. American Water Works Association Research Foundation. American Water Works Association. Prepared by Erica Hargesheimer.
- AWWARF. 2000b. *Particle Count Method Development for Concentration Standards and Sample Stabilisation*. American Water Works Association Research Foundation. ISBN 1583210423, American Water Works Association.
- Bouchier I. 1998. *Cryptosporidium in Water Supplies*. Third Report of the Group of Experts to: Department of the Environment, Transport and the Regions & Department of Health (UK). <http://dwi.defra.gov.uk/research/bouchier/index.htm>.
- Bukhari Z, Hargy T, Bolton J, et al. 1999. Medium-pressure UV for oocyst inactivation. *J AWWA* 91(3): 86–94.
- Burlingame G, Pickel M, Roman J. 1998. Practical applications of turbidity monitoring. *J AWWA* 90(8): 57–69.

- Clancy J, Bukhari Z, Hargy T, et al. 1998. *Inactivation of Cryptosporidium Parvum Oocysts using Medium-pressure Ultraviolet Light in Bench and Pilot Scale Studies*. San Diego, CA: Proceedings 1998 American Water Works Association Water Quality Technology Conference, November 1–4.
- Clark R, Sivagansan M, Rice E, et al. 2002. Development of a C.t equation for the inactivation of *Cryptosporidium* oocysts with ozone. *Wat Res* 36: 3141–9.
- Clark R, Sivagansan M, Rice E, et al. 2003. Development of a C.t equation for the inactivation of *Cryptosporidium* oocysts with chlorine dioxide. *Wat Res* 37(11): 2773–83.
- Connell K, Rodgers C, Shank-Givens H, et al. 2000. Building a better protozoa data set. *J AWWA* 92(10): 30–43.
- Cornwell D, LeChevallier M. 2001. *Treatment Options for Removal of Giardia, Cryptosporidium, and other Contaminants in Recycled Backwash Water*. Denver, CO: American Water Works Association Research Foundation.
- Craik S, Finch G, Bolton J, et al. 2000. Inactivation of *Giardia muris* cysts using medium-pressure ultraviolet radiation in filtered drinking water. *Wat Res* 34(18): 4325–32.
- Dugan N, Fox K, Owens J, et al. 2001. Controlling *Cryptosporidium* oocysts using conventional treatment. *J AWWA* 93(12): 64–76.
- DVGW W294. 2006. *Deutsche Vereinigung des Gas- und Wasserfaches* (German Association for Gas and Water). This is the German standard for UV disinfection. Part 1 covers design, function and action. Part 2 covers design, function and disinfection effectiveness. Part 3 covers sensors for the photometric monitoring of UV-disinfection; tests and calibration.
- DWI. 2010. *Guidance on the Use of Ultraviolet Irradiation for the Disinfection of Public Water Supplies*. 16 pp. Drinking Water Inspectorate, DEFRA, London. <http://www.dwi.gov.uk/stakeholders/guidance-and-codes-of-practice/>.
- DWI. 2014. A critical appraisal of existing guidance on online monitor performance data. Report No.: UC9882. 184 pp. <http://dwi.defra.gov.uk/research/completed-research/reports/DWI70-2-285.pdf> or <http://dwi.defra.gov.uk/>.
- DWI. 2016. Comparison of Private Water Supply and Public Water Supply Ultraviolet (UV) Systems: Final Report. Report Reference: DEFRA10932.05. 177 pp. <http://dwi.defra.gov.uk/research/completed-research/reports/DWI70-2-306.pdf>.
- Emelko M, Huck P, Slawson R. 1999. *Design and Operational Strategies for Optimising Cryptosporidium Removal by Filters*. Proceedings of 1999 Water Quality Technology Conference. Denver, CO: American Water Works Association.
- Emelko M, Huck P, Douglas I, et al. 2000. *Cryptosporidium and Microsphere Removal During Low Turbidity End-of-run and Early Breakthrough Filtration*. Proceeding of Water Quality Technology Conference. Denver, CO: American Water Works Association.
- Enriquez C, Greba C. 1999. *Evaluation of the Osmonics Water Purification Filters FGF, FAP and SXE in their Ability to Remove Cryptosporidium parvum Oocysts*. Final Report. Tucson, AZ: University of Arizona.

EPA/NSF ETV. 2005. *Protocol for Equipment Verification Testing for Physical Removal of Microbiological and Particulate Contaminants*. Prepared by NSF International, Ann Arbor, MI for USEPA. 40 CFR 35.6450. See:

<http://www.epa.gov/etv/pubs/059205epadwctr.pdf>.

Fogel D, Isaac-Renton J, Guasparini R, et al. 1993. Removing *Giardia* and *Cryptosporidium* by slow sand filtration. *J AWWA* 85(11): 77–84.

Fondriest Environmental Inc. 2014. Measuring Turbidity, TSS, and Water Clarity. In *Fundamentals of Environmental Measurements*. 5 September 2014.

<http://www.fondriest.com/environmental-measurements/equipment/measuring-water-quality/turbidity-sensors-meters-and-methods/> or for other parameters:

<https://www.fondriest.com/environmental-measurements/parameters/water-quality/>.

GLI. No date. *GLI Method 2 (ie, re turbidity measurement: USEPA GLI 2)*. Milwaukee, WI: Great Lakes International Inc. See USEPA 1999.

Goodrich J, Li S, Lykins B. 1995. *Cost and Performance Evaluations of Alternative Filtration Technologies for Small Communities*. Proceedings of the Annual Conference of the American Water Works Association. Denver, CO.

Hach Method 10133. *Determination of Turbidity by Laser Nephelometry*. Revision 2.0, 7 January 2000, available at: <http://www.hach.com> and search for 10133. Or Google Hach Method 10133.

Hall T, Pressdee J, Carrington E. 1994. *Removal of Cryptosporidium Oocysts by Water Treatment Processes*. Report No. FR0457, Bucks, UK: Foundation for Water Research.

Hancock CM. 1999. Using indigenous microbiota to monitor water quality. *Water Supply* 17(2): 91–4.

Harrington G, Chen H, Harris A, et al. 2001. *Removal of Emerging Waterborne Pathogens*. Denver, CO: American Water Works Association Research Foundation.

Harris SI, Hancock CM, Vasconcelos J. 1996. *Microscopic Particulate Analysis for Filtration Plant Optimisation*. Seattle, Washington: USEPA, Region X, EPA/910/R/96/01.

Harter T, Wagner S, Atwill E. 2000. Colloid transport and filtration of *Cryptosporidium parvum* in sandy soils and aquifer sediments. *Environ Sci Technol* 34: 62–70.

Health Canada. 2012. Guidelines for Canadian Drinking Water Quality Guideline Technical Document. Enteric Protozoa: *Giardia* and *Cryptosporidium*. 104 pp. [http://www.hc-sc.gc.ca/ewh-semt/pubs/water-eau/index-eng.php#tech\\_doc](http://www.hc-sc.gc.ca/ewh-semt/pubs/water-eau/index-eng.php#tech_doc).

IANZ. 2005. *General Requirements for the Competence of Testing and Calibration Laboratories*. (NZS/ISO/IEC 17025). Auckland: International Accreditation New Zealand. <http://www.ianz.govt.nz/>.

ISO. 1999. *International Standard 7027 – Water Quality – Determination of turbidity*. Geneva, Switzerland: International Organisation for Standardisation.

Letterman R, Johnson C, Viswanathan S, et al. 2001. *A Study of Low Level Turbidity Measurements*. Denver, CO: American Water Works Association Research Foundation.

- Li S, Goodrich J, Owens J, et al. 1997. Reliability of surrogates for determining *Cryptosporidium* removal. *J AWWA* 89(5): 90.
- Li H, Finch G, Smith D, et al. 2001. *Sequential Disinfection Design Criteria for Inactivation of Cryptosporidium Oocysts in Drinking Water*. Denver, CO: American Water Works Association Research Foundation.
- Long WR. 1983. Evaluation of cartridge filters for the removal of *Giardia lamblia* cyst models from drinking water systems. *Journal of Environmental Health* 45(5): 220.
- McKenzie, et al. 1994. A massive outbreak in Milwaukee of *Cryptosporidium* infection transmitted through the public water supply. *New England J Med* 331 33(3): 161–7.
- MoH Public Health Risk Management Plan Guide PHRMP Ref S1.1. *Surface and Groundwater*. Wellington: Ministry of Health. Available on the Ministry of Health website: <http://www.health.govt.nz/water> then select publications and Water Safety Plans.
- Ministry of Health. 2000. *Drinking-water Standards for New Zealand 2000*. Wellington: Ministry of Health.
- Ministry of Health. 2005. *Drinking-water Standards for New Zealand 2005*. Wellington: Ministry of Health.
- NSF/ANSI 53. *Drinking-water Treatment Units Health Effects*. Ann Arbor, MI. Note that NSF continually updates their standards. The latest version is: NSF/ANSI 53-2014: *Drinking Water Treatment Units: Health effects*, 89 pp plus appendices.
- NSF/ANSI 55. *Ultraviolet Microbiological Water Treatment Systems*. Ann Arbor MI. Latest version 2014, 36 pp plus appendices.
- Ongerth J, Hutton P. 2001. Testing of diatomaceous earth filtration for removal of *Cryptosporidium* oocysts. *J AWWA* 93(12): 54–63.
- ÖNORM. 2001. *Plants for the Disinfection of Water using Ultraviolet Radiation: Requirements and testing*. ÖNORM 5873-1 (this is for low pressure lamps). Österreichisches Normungsinstitut, A-1021 Wien. See <http://www.on-norm.at>.
- ÖNORM. 2003. *Plants for the Disinfection of Water using Ultraviolet Radiation: Requirements and testing*. ÖNORM 5873-2 (this is for medium pressure lamps). Österreichisches Normungsinstitut, A-1021 Wien. See <http://www.on-norm.at>.
- Oppenheimer J, Aieta E, Trussell R, et al. 2000. Evaluation of *Cryptosporidium* inactivation in natural waters. Denver, CO: American Water Works Association Research Foundation.
- Owens J, Miltner R, Slifko T, et al. 1999. *In Vitro Excystation and Infectivity in Mice and Cell Culture to Assess Chlorine Dioxide Inactivation of Cryptosporidium Oocysts*. In Proceedings of the Water Quality Technology Conference of the American Water Works Association. Denver, CO.
- Owens J, Miltner R, Rice E, et al. 2000. Pilot-scale ozone inactivation of *Cryptosporidium* and other micro-organisms in natural water. *Ozone Sci Eng* 22(5): 501–17.
- Patania N, Jacangelo J, Cummings L, et al. 1995. *Optimisation of Filtration for Cyst Removal*. AWWARF. Denver, CO, 178 pp.



Qian SS, Donnelly M, Scmelling DC, et al. 2004. Ultraviolet light inactivation of protozoa in drinking water: a Bayesian meta-analysis. *Water Research* 38: 317–26.

Rennecker J, Marinas B, Owens J, et al. 1999. Inactivation of *Cryptosporidium parvum* oocysts with ozone. *Water Res* 33(11): 2481–8.

Rice EW, Fox KR, Miltner RJ, et al. 1996. Evaluating treatment plant performance using indigenous aerobic bacterial endospores. *J AWWA* 88(9): 122–30.

Ruffell K, Rennecker J, Marinas B. 2000. Inactivation of *Cryptosporidium parvum* oocysts with chlorine dioxide. *Wat Res* 34(3): 868–76.

Sadar M. 1999. *Turbidimeter Instrument Comparison: Low-level sample measurements technical information series*. Hach Company. ap/dp 4/99 1ed rev1 D90.5 Lit No. 7063.

Schaub S, Hargett H, Schmidt M, et al. 1993. *Reverse Osmosis Water Purification Unit: Efficacy of cartridge filters for removal of bacteria and protozoan cysts when RO elements are bypassed*. Fort Detrick, Frederick, MD: US Army Biomedical Research and Development Laboratory.

Scottish Water. 2003. The *Cryptosporidium* (Scottish Water) Directions 2003. Available on: <http://www.scotland.gov.uk/Publications/2004/01/18727/31490>.

USAPHC. March 2006, updated January 2011. Iodine Disinfection in the Use of Individual Water Purification Devices. Technical Information Paper #-31-005-0211, prepared by: Steven H. Clarke, Environmental Engineer. US Army Public Health Command. 15 pp.  
<http://phc.amedd.army.mil/PHC%20Resource%20Library/Iodine%20Disinfection%20in%20the%20Use%20of%20Individual%20Water%20Purification%20Devices.pdf>

USEPA. 1993a. *Method 180.1, Determination of Turbidity by Nephelometry*. Appears as Appendix B of Guidance Manual, Turbidity Provisions, USEPA 1999. Cincinnati: United States Environmental Protection Agency. Available on the internet at: [http://www.epa.gov/OGWDW/mdbp/pdf/turbidity/app\\_b.pdf](http://www.epa.gov/OGWDW/mdbp/pdf/turbidity/app_b.pdf) or go to <http://water.epa.gov/lawsregs/rulesregs/sdwa/mdbp/mdbptg.cfm>.

USEPA. 1993b. *Method 180.2, Turbidity GLI Method 2*. Appears as Appendix D of Guidance Manual, Turbidity Provisions, USEPA 1999. Cincinnati: United States Environmental Protection Agency. Available on the internet at: [http://www.epa.gov/OGWDW/mdbp/pdf/turbidity/app\\_d.pdf](http://www.epa.gov/OGWDW/mdbp/pdf/turbidity/app_d.pdf) or go to <http://water.epa.gov/lawsregs/rulesregs/sdwa/mdbp/mdbptg.cfm>.

USEPA. 1998. *Water Supply Performance Evaluation Study #41*. National Exposure Research Laboratory. Office of Research and Development.

USEPA. 1999. *Guidance Manual for Compliance with the Interim Enhanced Surface Water Treatment Rule: Turbidity provisions*. EPA 815-R-99-010. Document is available for download at: <http://www.epa.gov/safewater/mdbp/mdbptg.html> or go to <http://www.epa.gov/lawsregs/rulesregs/sdwa/mdbp/implement.cfm>.

USEPA. 2001a. *Low-Pressure Membrane Filtration for Pathogen Removal: Application, implementation, and regulatory issues*. EPA 815-C-01-001. Document is available for download at: <http://www.epa.gov/safewater/disinfection/lt2/compliance.html> or go to <http://www.epa.gov/lawsregs/rulesregs/sdwa/lt2/compliance.cfm>.

USEPA. 2001b. *Method 1622: Cryptosporidium in Water by Filtration/IMS/FA*. EPA-821-R-01-026, April. Now see USEPA 2005b.

USEPA. 2001c. *Method 1623: Cryptosporidium and Giardia in Water by Filtration/IMS/FA*. EPA 821-R-01-025, April. Now see USEPA 2005b.

USEPA. 2002. *Hach Filter Trak Method 10133: Determination of turbidity by laser nephelometry*. Revision 2.0. Fed Regist 67(209), 40 CFR §141.74, 29 October. US Environmental Protection Agency. Description can be obtained from Hach Co, Loveland, CO, or the New Zealand agents. See Hach (above) for internet address.

USEPA. 2003. *Long Term 2 Enhanced Surface Water Treatment Rule – Toolbox Guidance Manual* [Draft]. EPA 815-D-03-009. United States Environmental Protection Agency, Office of Water, Washington. 333 pp. (See USEPA 2009 for latest next draft and 2010 for final).

[http://www.epa.gov/safewater/disinfection/lt2/pdfs/guide\\_lt2\\_toolbox.pdf](http://www.epa.gov/safewater/disinfection/lt2/pdfs/guide_lt2_toolbox.pdf) or go to <http://www.epa.gov/lawsregs/rulesregs/sdwa/lt2/compliance.cfm>.

USEPA. 2003a. *Long Term 2 Enhanced Surface Water Treatment Rule; Proposed Rule*. National Primary Drinking Water Regulations: 40 CFR Parts 141 and 142, August 11. Now see USEPA 2006a for Final Rule.

USEPA. 2003b. *Small Drinking Water Systems Handbook: A guide to 'packaged' filtration and disinfection technologies with remote monitoring and control tools*. EPA/600/R-03/041. Office of Research and Development. Water Supply and Water Resources Division, United States Environmental Protection Agency.

USEPA. 2003c. *Membrane Filtration Guidance Manual*. (Proposal draft). EPA 815-D-03-008. Washington: United States Environmental Protection Agency. Now refer to USEPA 2005a.

USEPA. 2003d. *Ultraviolet Disinfection Guidance Manual*. (Draft). EPA-815-D-03-007. Washington: United States Environmental Protection Agency. Now refer to USEPA 2006c.

USEPA. 2005a. *Membrane Filtration Guidance Manual*. EPA 815-R-06-009. Washington: United States Environmental Protection Agency, Office of Water. Available at: [http://www.epa.gov/ogwdw/disinfection/lt2/pdfs/guide\\_lt2\\_membranefiltration\\_final.pdf](http://www.epa.gov/ogwdw/disinfection/lt2/pdfs/guide_lt2_membranefiltration_final.pdf) or go to <http://www.epa.gov/lawsregs/rulesregs/sdwa/lt2/compliance.cfm>.

USEPA. 2005b. *Method 1623: Cryptosporidium and Giardia in Water by Filtration/IMS/FA*. Washington, DC: US Environmental Protection Agency, Office of Water. EPA-815-R-05-002. Document is available for download at: [www.epa.gov/nerlcwww/1623de05.pdf](http://www.epa.gov/nerlcwww/1623de05.pdf) or go to <http://www.epa.gov/microbes/online.html>.

USEPA. 2006a. *National Primary Drinking Water Regulations: Long term 2 enhanced surface water treatment rule: final rule*. (LT2ESWTR). Federal Register Part II, 40 CFR Parts 9, 141 and 142. Washington: National Archives and Records Administration. See <http://www.epa.gov/fedrgstr/EPA-WATER/2006/January/Day-05/w04a.pdf> <http://www.epa.gov/fedrgstr/EPA-WATER/2006/January/Day-05/w04b.pdf> <http://www.epa.gov/fedrgstr/EPA-WATER/2006/January/Day-05/w04c.pdf> or go to <http://www.epa.gov/lawsregs/rulesregs/sdwa/lt2/compliance.cfm>.

USEPA. 2006b. *Source Water Monitoring Guidance Manual for Public Water Systems for the Long Term 2 Enhanced Surface Water Treatment Rule*. Washington, DC: USEPA, Office of Water (4601M). EPA 815-R06-005. Available at:

[http://www.epa.gov/ogwdw/disinfection/lt2/pdfs/guide\\_lt2\\_swmonitoringguidance.pdf](http://www.epa.gov/ogwdw/disinfection/lt2/pdfs/guide_lt2_swmonitoringguidance.pdf) or go to

<http://www.epa.gov/lawsregs/rulesregs/sdwa/lt2/compliance.cfm>.

USEPA. 2006c. *Ultraviolet Disinfection Guidance Manual for the Long Term 2 Enhanced Surface Water Treatment Rule*. EPA-815-R-06-007. Washington: United States Environmental Protection Agency, Office of Water. Available at:

[www.epa.gov/safewater/disinfection/lt2/pdfs/guide\\_lt2\\_uvguidance.pdf](http://www.epa.gov/safewater/disinfection/lt2/pdfs/guide_lt2_uvguidance.pdf).

USEPA. 2006d. *Microbial Laboratory Guidance Manual for the Final Long-Term 2 Enhanced Surface Water Treatment Rule*. Office of Water, EPA 815-R06-006, February.

See: <http://www.epa.gov/safewater/disinfection/lt2/compliance.html> or go to

<http://www.epa.gov/lawsregs/rulesregs/sdwa/lt2/compliance.cfm>.

USEPA. 2009. *Long Term 2 Enhanced Surface Water Treatment Rule: Toolbox Guidance Manual*. Review Draft. EPA-815-D-09-001. 340 pp. Washington: United States Environmental Protection Agency. Go into

<http://www.epa.gov/safewater/disinfection/lt2/> and then enter: toolbox guidance manual review draft in the 'search' box. See

[www.epa.gov/safewater/disinfection/lt2/pdfs/guide\\_lt2\\_lt2eswtr\\_toolboxgm\\_rev\\_draft\\_060809.pdf](http://www.epa.gov/safewater/disinfection/lt2/pdfs/guide_lt2_lt2eswtr_toolboxgm_rev_draft_060809.pdf) or <http://nepis.epa.gov/Exe/ZyPURL.cgi?Dockey=P1004501.txt>.

USEPA. 2010. *Long Term 2 Enhanced Surface Water Treatment Rule: Toolbox Guidance Manual*. EPA-815-D-09-016. 375 pp. Washington: United States Environmental Protection Agency.

[http://www.epa.gov/safewater/disinfection/lt2/pdfs/guide\\_lt2\\_toolboxguidancemanual.pdf](http://www.epa.gov/safewater/disinfection/lt2/pdfs/guide_lt2_toolboxguidancemanual.pdf).

USEPA. 2011. Protocol for Development of Test / Quality Assurance Plans for Validation of Ultraviolet (UV) Reactors. Environmental Technology Verification Protocol (ETV). 10/01/EPADWCTR. 12/01/EPADWCTR. Prepared by NSF. 39 pp.

<http://www.epa.gov/etv/pubs/600etv12004.pdf>.

USEPA. 2012. Generic Verification Protocol for Verification of Online Turbidimeters. ETV Advanced Monitoring Systems Center (ETV). 57 pp.

[http://www.epa.gov/etv/pubs/AMS\\_onlineturbidimeters072012.pdf](http://www.epa.gov/etv/pubs/AMS_onlineturbidimeters072012.pdf).

USEPA. 2012a. Generic Protocol for the Product Specific Challenge Testing of Bag and Cartridge Filter Systems. Environmental Technology Verification Protocol (ETV). 12/01/EPADWCTR. Prepared by NSF. 24 pp.

[http://www.epa.gov/etv/pubs/01\\_vp\\_drt.pdf](http://www.epa.gov/etv/pubs/01_vp_drt.pdf).

USEPA. Regularly updated. *Analytical Methods Approved for Compliance Monitoring under the Enhanced Surface Water Treatment Rule*. See

[http://www.epa.gov/safewater/methods/pdfs/methods/methods\\_swtrules.pdf](http://www.epa.gov/safewater/methods/pdfs/methods/methods_swtrules.pdf) or go to <http://www.epa.gov/microbes/online.html>.

Vasconcelos J, Harris SI. 1992. *Consensus Method for Determining Groundwaters under the Direct Influence of Surface Water Using Microscopic Particulate Analysis (MPA)*. Port Orchard, WA: USEPA, Manchester Environmental Laboratory. Report 910/9-92-029.

Walsh DS, et al. 1980. Ozone inactivation of floc associated viruses and bacteria. *J Environ Eng Div ASCE* 106: 711–26.

WHO. 2004. *Guidelines for Drinking-water Quality 2004* (3rd edition). Geneva: World Health Organization. Available at: [www.who.int/water\\_sanitation\\_health/dwq/gdwq3/en/print.html](http://www.who.int/water_sanitation_health/dwq/gdwq3/en/print.html) see also the addenda.

WHO. 2004a. *Water Treatment and Pathogen Control: Process efficiency in achieving safe drinking water*. 136 pp. [www.who.int/water\\_sanitation\\_health/publications/en/index.html](http://www.who.int/water_sanitation_health/publications/en/index.html).

WHO. 2006. Cryptosporidium – *WHO Guidelines for Drinking Water Quality; EHC Cryptosporidium draft 2*. 138 pp. [http://www.who.int/water\\_sanitation\\_health/gdwqrevision/cryptodraft2.pdf](http://www.who.int/water_sanitation_health/gdwqrevision/cryptodraft2.pdf).

WHO. 2009. *Risk Assessment of Cryptosporidium in Drinking Water*. WHO/HSE/WSH/09.04. 143 pp. [http://whqlibdoc.who.int/hq/2009/WHO\\_HSE\\_WSH\\_09.04\\_eng.pdf](http://whqlibdoc.who.int/hq/2009/WHO_HSE_WSH_09.04_eng.pdf).

WHO. 2011. *Guidelines for Drinking-water Quality 2011* (4th edition). Geneva: World Health Organization. Available at: [http://www.who.int/water\\_sanitation\\_health/publications/2011/dwq\\_guidelines/en/index.html](http://www.who.int/water_sanitation_health/publications/2011/dwq_guidelines/en/index.html).

WHO. 2015. *Boil Water*. Technical Brief. WHO/FWC/WSH/15.02. 2 pp. [http://www.who.int/water\\_sanitation\\_health/dwq/Boiling\\_water\\_01\\_15.pdf?ua=1](http://www.who.int/water_sanitation_health/dwq/Boiling_water_01_15.pdf?ua=1).

WHO. 2017. *Guidelines for Drinking-water Quality: Fourth edition incorporating the first Addendum*. Geneva: World Health Organization. 631 pp. [http://www.who.int/water\\_sanitation\\_health/publications/drinking-water-quality-guidelines-4-including-1st-addendum/en/](http://www.who.int/water_sanitation_health/publications/drinking-water-quality-guidelines-4-including-1st-addendum/en/).

WRF. 2015. *Guidance for Implementing Action Spectra Correction with Medium Pressure UV Disinfection*. Water Research Foundation, US Environmental Protection Agency, American Water Works Association. 150 pp. <http://waterrf.org/PublicReportLibrary/4376.pdf>.

# Appendix: Guidance Notes: Interpretation of Catchment Protozoal Risk Category

To be read in conjunction with section 8.2.

This guidance document aims to provide additional information to enable interpretation of Table 5.1a in situations where it is not entirely clear which log credit category is most appropriate.

Although the DWSNZ refer to either *Cryptosporidium* monitoring or Catchment Assessment as being the 'standard approach' dependent on population served, it should be noted that the *Cryptosporidium* monitoring option is considered the more accurate and therefore the preferred method for assigning log credits to source waters. Table 5.1a is necessarily conservative and its use may lead to overdesign of capital works for treatment and extra ongoing running costs for a community.

## Part 1: Surface waters

|   |       |
|---|-------|
| Water from forest, bush, scrub or tussock catchments with no agricultural or human activity | 3 Log |
|---|-------|

This category does not present interpretation difficulties. It is generally clear which catchments fit into this category. No further guidance is considered necessary.

|   |       |
|---|-------|
| Water from pastoral catchments that always has low concentration of cattle, sheep, horses or humans in immediate vicinity or upstream | 4 Log |
|---|-------|

|  |       |
|--|-------|
| Water from pastoral catchments with frequent high concentrations of cattle, sheep, horses or humans, or a waste treatment outfall nearby or upstream | 5 Log |
|--|-------|

The 4 and 5 log surface water categories have caused some interpretation difficulties, particularly the descriptions 'frequent high' and 'always low'. Unfortunately defining these terms by providing absolute numbers or stock densities (eg, stock units, or numbers of animals per unit area) is not in itself beneficial in terms of establishing the associated risk.

Preliminary results from raw water *Cryptosporidium* monitoring in New Zealand catchments indicate that there are likely to be very few catchments in New Zealand that present a protozoal risk great enough to require 5 log protozoal removals. It is on the basis of this information that the following guidance is provided. The aim is to ensure that water suppliers are not unreasonably burdened with the requirement for 5 log treatment (as the precautionary approach in Table 5.1a appears to direct) when the risk may not warrant it.

These guidelines contain a list of 'alert criteria' that should be considered in situations where it is difficult to determine whether a catchment fits into the 4 or 5 log category. The alert criteria are land use activities and discharges known to be associated with greater protozoal contamination. Interpretation difficulties generally arise in situations where the influence of animals in the catchment is unclear. For example, Table 5.1a states that the 5 log category should be assigned in situations where a waste treatment outfall is 'nearby or upstream'. The proximity of the point source discharge to the intake is critical and therefore these guidelines propose that distance from the intake be considered prior to the 5 log category being automatically assigned to such sources.

If none of the alert criteria are met the catchment should be assigned 4 log category.

## Alert criteria (surface waters in 4 or 5 log categories)

### Point source<sup>1</sup> discharges

- Waste treatment discharge to water (eg, sewage outfall, meatworks effluent discharge) up to 1000 m upstream of intake or 100 m downstream.
- Stormwater discharges (via discharge pipe) up to 1000 m upstream of intake or 100 m downstream.

### Non-point source<sup>2</sup> discharges

- Animal effluent disposal (to land) up to 500 m upstream of intake (eg, dairy shed effluent, pig effluent, truck effluent disposal).
- Animal (cattle, sheep, deer, horse) access to waterway (no fencing or riparian boundary) within 1000 m upstream of intake.
- Sewage disposal to land (if there are concerns about the effectiveness of treatment) within 500 m upstream of intake.
- Large numbers of feral animals within 500 m of intake.
- Any other activity that results in high concentrations of animals being present (other than on hard stand areas where effluent is collected for treatment) eg, livestock sale yards, animal transport company holding yards within 500 m of intake, farm practices such as 'sacrifice' or 'wintering off' paddocks used at high stocking rates to protect other pasture during wet periods, strip grazing of livestock herds).

<sup>1</sup> Point source = a stationary point of pollution, such as a discharge pipe.

<sup>2</sup> Non-point source = diffuse pollution sources (ie, without a single point of origin or not introduced into the receiving water from a specific outlet).

Where contaminating land uses are present take into consideration the slope of the land to determine likelihood of impact on the intake area.

### Mitigating factors for surface waters

These are factors that may reduce the likelihood of high levels of protozoa contamination reaching a treatment plant intake despite factors above being present. Mitigating factors include, but may not be limited to:

- the flow rate of the river or stream relative to the discharge rate of a point source – high river flows coupled with low discharge rates will help dilute contaminant levels
- a well-designed, managed and maintained riparian strip
- impoundment of some description before abstraction – the longer the residence time the greater the reduction in microbial contaminants
- for lakes and reservoirs – the distance between the shore and intake
- the level to which wastewater or meatworks effluent has been treated before discharge.

### Response if one or more of 'alert criteria' met and no mitigating factors

Drinking water assessors should not immediately assign a 5 log categorisation to water sources that meet one or more of the alert criteria (and no mitigating factors in place). Water suppliers with sources in this category (or in circumstances where the supplier disagrees with the log credit category assigned as a result of the assessment) should be strongly encouraged/advised to undertake raw water *Cryptosporidium* monitoring to confirm the appropriate log credit.

It should be noted that any drinking water supply eligible for DWAP is not likely to be recommended for subsidy funding if 5 log credits have been assigned to it and that this has not been confirmed by raw water *Cryptosporidium* monitoring.

## Part 2: Bore water supplies

Bore water drawn from >10 m deep: the bore water section of Table 5.1a is clear.

Bore water drawn from <10 m deep: Table 5.1a is difficult to apply to groundwater <10 m deep. Source waters in this category are directed into the surface water section of the table, but these categories are unhelpful in assessing the risk associated with groundwaters that have no hydraulic link<sup>3</sup> to a surface water source. The surface water categories of Table 5.1a should be directly applied to groundwaters that are known to be hydraulically linked to a nearby surface water source.

<sup>3</sup> Hydraulic link = this is when surface water and groundwater are directly linked. When water is pumped from a well that is hydraulically connected to a nearby stream, it reduces the flow in the stream. Where turbidity increases in groundwater after heavy rain has increased the turbidity in nearby surface water, this is an indication of a hydraulic link.

Part 2 of this guidance document aims to provide additional guidance on assigning a log removal category for bore water drawn from <10 m deep.

The DWA should request that the water supplier provides information about land use activities and discharges occurring in two zones around the well: a 5–50 m ‘inner’ buffer zone and a 50–250 m ‘wider’ buffer zone. The water supplier also needs to provide information on the soil and sub-surface materials. This type of information may be available through the regional council. The DWA should then consider the impact of activities occurring within the two zones and determine the applicable log removal category by reference to Tables 1 and 2 below. An additional set of mitigating factors (outlined below) can be considered for bore water drawn from <10m deep that fall into the 5 log category (and may enable them to be reduced to 4 log).

### ‘Impact of activity’ descriptions

None: no sources of animal or human faecal contamination.

Low: livestock and/or feral animal and/or human faecal contamination sources are present but do not meet the level(s) of intensity described under the ‘high’ impact description below.

High: one or more of the following land use activities is present:

- on-site sewage disposal (eg, septic tanks, soakage/boulder pits)
- offal pits
- effluent storage ponds / effluent spraying / effluent disposal by border dyke irrigation
- high stocking rates<sup>4</sup> (eg, ‘sacrifice’ or ‘wintering off’ paddocks used at high stocking rates to protect other pasture during wet periods, strip grazing of livestock herds)
- any other activity that results in high concentrations of animals being present (other than on hard stand areas where effluent is collected for treatment) eg, livestock saleyards, animal transport company holding yards.

Note: Drinking water suppliers should endeavour to exclude high risk sites when selecting a location for a new drinking water source. The Resource Management (National Environmental Standards for Sources of Human Drinking Water) Regulations 2007 should be consulted where new contaminating land uses are proposed that may impact on existing water sources. Obtaining a higher quality source water may be a better option than investing in more extensive treatment.

<sup>4</sup> Definitions for stocking rates vary. Average stocking rate for dairy cattle in New Zealand in 2010 was 2.8 cows per hectare (DairyNZ). Definitions vary, but generally rates above 3.5–4.0 cows per hectare are considered high. Stocking rates are calculated over the area of the farm. Farm practices that concentrate large numbers of animals into small areas are of more significance in terms of contaminant runoff and leaching into groundwater.



**Table 8A1: Log removal requirements for bore waters <10 m deep based on land use activities and soil / sub-surface material permeability**

| Fenced exclusion zone (5m) | Impact of activity in inner buffer zone (refer to definitions above) (5–50m) | Impact of activity in wider buffer zone (refer to definitions above) (50–250m) | Soil permeability (refer to Table 2 below) |      | Sub-surface permeability (refer to Table 2 below) |      | Log treatment requirement |
|----------------------------|--|--|--|------|---|------|---------------------------|
|                            |  |  | Low  | High | Low   | High |                           |
| Yes                        | None   | None   | N/A  | N/A  | N/A   | N/A  | 3                         |
| Yes                        | None   | Low  | ✓  |      | ✓   |      | 3                         |
| Yes                        | None   | Low  | ✓  |      |   | ✓    | 4                         |
| Yes                        | None   | Low  |  | ✓    | ✓   |      | 3                         |
| Yes                        | None   | Low  |  | ✓    |   | ✓    | 4                         |
| Yes                        | None   | High   | ✓  |      | ✓   |      | 4                         |
| Yes                        | None   | High   | ✓  |      |   | ✓    | 5                         |
| Yes                        | None   | High   |  | ✓    | ✓   |      | 4                         |
| Yes                        | None   | High   |  | ✓    |   | ✓    | 5                         |
| Yes                        | Low  | Low  | ✓  |      | ✓   |      | 3                         |
| Yes                        | Low  | Low  | ✓  |      |   | ✓    | 3                         |
| Yes                        | Low  | Low  |  | ✓    | ✓   |      | 4                         |
| Yes                        | Low  | Low  |  | ✓    |   | ✓    | 4                         |
| Yes                        | Low  | High   | ✓  |      | ✓   |      | 4                         |
| Yes                        | Low  | High   | ✓  |      |   | ✓    | 5                         |
| Yes                        | Low  | High   |  | ✓    | ✓   |      | 4                         |
| Yes                        | Low  | High   |  | ✓    |   | ✓    | 5                         |
| Yes                        | High   | N/A  | ✓  |      | ✓   |      | 4                         |
| Yes                        | High   | N/A  | ✓  |      |   | ✓    | 4                         |
| Yes                        | High   | N/A  |  | ✓    | ✓   |      | 5                         |
| Yes                        | High   | N/A  |  | ✓    |   | ✓    | 5                         |
| No                         |  |  |  |      |   |      | 5                         |

**Table 8A2: Sub-surface media and soil categories**

|   | Sub-surface media   | Soils  |
|---|---|--|
| High filtration* media/soils  | Pumice sand<br>Clay   | Raw and recent soils<br>Semiarid soils<br>Pumice soils<br>Allophanic soils |
| Low filtration media/soils (some of these are more accurately described as 'medium' filtration materials but for the purposes of categorising for Table 1 they are considered 'low filtration') | Gravel<br>Alluvial sand<br>Coastal sand<br>Sandstone<br>Fractured rock<br>Silt<br>Ash<br>Peat | All other types of soils   |

\* A 'high filtration' media/soil indicates that water that passes through the media will have been subjected to a high level of filtration. Not to be confused with soils that are 'free draining', meaning that liquids pass through the media easily.

## Mitigating factors for bore waters <10 m deep in 5 log category

Bore waters <10 m deep that Table A1 identifies as requiring 5 log treatment may be reduced to 4 log if the DWA considers that sufficient mitigating factors are in place that reduce the likelihood of the high risk activity causing contamination of the source. The following are examples of mitigating factors that should be considered:

**On-site sewage disposal:** systems that incorporate newer treatment technology are far less likely to present a risk to groundwater than older style systems. Consider also the nature of the disposal field (boulder pit / soakage pits present much higher risk than trickle irrigation systems).

**Groundwater flow:** good information on groundwater flow may alleviate concerns about some potentially contaminating land-use activities (that have been identified within the buffer zone) if the direction of groundwater flow shows the land use will not impact on water drawn in by the well.

**Soil thickness:** the greater the soil thickness, the greater the removal of oocysts.

**Soil type:** allophanic and pumice soils are extremely efficient in removing microbes from water permeating through them. If it is determined that these types of soil are present, a 3 log requirement can be assigned to the system.

Drinking water assessors should not immediately assign a 5 log categorisation to any groundwater source. Water suppliers with sources in this category (or in circumstances where the supplier disagrees with the log credit category assigned as a result of the assessment) should be strongly encouraged/advised to undertake raw water *Cryptosporidium* monitoring to confirm the appropriate log credit.

It should be noted that any drinking water supply eligible for DWAP is not likely to be recommended for subsidy funding if 5 log credits have been assigned to it and that this has not been confirmed by raw water *Cryptosporidium* monitoring.

## Part 3: Five-yearly reassessment of protozoa risk category

The DWSNZ require that water suppliers >10,000 redo their protozoa monitoring programme every five years and that water suppliers <10,000 redo their catchment assessment every five years. A water supplier <10,000 that has elected to do protozoa monitoring to establish their initial log credit requirement may choose to do catchment assessments for the subsequent five yearly reassessments. Suppliers in this category may remain on the original log credit (determined by protozoa monitoring) if the catchment assessment confirms that no changes in the catchment have occurred that would have altered the protozoa risk. See section 8.2.6.

# Chapter 9: Cyanobacterial compliance

## Contents

|  |  |           |
|--|--|-----------|
| <b>9.1</b>   | <b>Introduction</b>  | <b>2</b>  |
| 9.1.1  | Algal bloom development  | 4         |
| 9.1.2  | Health significance of cyanotoxins                                   | 9         |
| 9.1.3  | Taste and odour caused by cyanobacteria                              | 11        |
| 9.1.4  | Occurrence of toxic cyanobacteria internationally and in New Zealand | 12        |
| <b>9.2</b>   | <b>Risk management</b>   | <b>15</b> |
| 9.2.1  | Assessment of risk   | 15        |
| <b>9.3</b>   | <b>Monitoring</b>  | <b>18</b> |
| <b>9.4</b>   | <b>Compliance</b>  | <b>21</b> |
| <b>9.5</b>   | <b>Sampling and testing</b>  | <b>24</b> |
| 9.5.1  | Sample testing   | 24        |
| 9.5.2  | Sample collection  | 25        |
| <b>9.6</b>   | <b>Transgressions</b>  | <b>32</b> |
| <b>9.7</b>   | <b>Risk reduction</b>  | <b>33</b> |
| 9.7.1  | Alert levels   | 33        |
| 9.7.2  | Preventive and remedial measures                                     | 36        |
| <b>9.8</b>   | <b>Recommended Reading</b>   | <b>48</b> |
| <b>Appendix 1: Chlorine C.t values for reducing microcystin-LR concentration to 1 µg/L in a batch or plug-flow reactor</b> |  | <b>49</b> |

## Appendix 2: Detailed Case Study for the Use of the WHO/IPCS Framework to Assess Risk to Human Health from Exposure to Microcystins in Drinking-water 49

## References 51

### List of tables

|  |    |
|--|----|
| Table 9.1: Example assessment of the potential for high biomass of planktonic cyanobacteria based on environmental conditions <sup>a</sup> | 5  |
| Table 9.3: Information that may help in situation assessment and management  | 16 |
| Table 9.5: Summary of performance for water treatment processes capable of removing cell-bound microcystins by removing whole cells        | 45 |
| Table 9.6: Efficiency of dissolved toxin removal by oxidants/disinfectants and activated carbons   | 47 |

### List of figures

|  |    |
|--|----|
| Figure 9.1: Rapid assessment of the level of risk posed by toxic cyanobacteria in a drinking water source                            | 17 |
| Figure 9.2: Procedure for use of the integrated hose-pipe sampler for planktonic cyanobacteria and cyanotoxins                       | 28 |
| Figure 9.3: Benthic cyanobacteria monitoring and sampling schematic of layout of transects and survey areas                          | 30 |
| Figure 9.4: Benthic cyanobacteria monitoring and sampling schematic of transect cross-section showing arrangement of sampling points | 31 |
| Figure 9.5: Alert levels framework for the management of cyanobacteria in water supplies   | 34 |

## 9.1 Introduction

This chapter provides information on cyanobacteria and cyanotoxins because of the increasing number of supplies that encounter difficulties with these micro-organisms, and because many water suppliers may have little understanding of how to manage them. Although prepared primarily for use in relation to drinking-water supplies, the information should also be of use to those managing recreational waters.

The purpose of this chapter is to provide:

- general information on cyanobacteria, the factors that control bloom formation, and their toxins and health significance
- advice on how the risk they present to consumers can be evaluated
- discussion on meeting the cyanotoxin compliance requirements of the DWSNZ

- guidance on how the public health risk associated with cyanotoxins can be managed.

For those who do not wish to read the full text in this chapter, but are concerned with information to support the requirements of the DWSNZ, the following sections are those of greatest importance:

- Compliance with the DWSNZ: see section 9.4
- Sampling: see section 9.5
- Transgressions: see section 9.6
- Risk management: see section 9.7
- Refer to the datasheets for cyanobacteria and for the individual cyanotoxins, in Volume 3 of the *Guidelines*.

Over recent years, water supplies in some parts of New Zealand have experienced an increase in the number of cyanobacterial blooms. These events have the potential to introduce toxins that can have acute and, if their concentrations are high enough, fatal consequences for consumers. Experience of such events in New Zealand is still relatively limited, and consequently this section provides substantial detail to assist water suppliers in dealing with cyanobacteria.

Cyanobacteria, which belong to the group of organisms called prokaryotes, are primarily aquatic organisms with many characteristics of bacteria. Unlike eukaryotes (which includes the algae), they are characterised by the lack of a true cell nucleus and other membrane-bound cell compartments such as mitochondria and chloroplasts. As their metabolism is based on photosynthesis and due to the blue and green pigments many cyanobacteria produce, they have also been termed blue-green algae. They may grow as filaments or colonies readily visible, or single-celled causing discolouration of water. They include planktonic (free-floating) and benthic (attached) species. Being microscopic (several micrometres wide or less), a microscope is required to identify cyanobacteria to the genus level.

Cyanobacteria are not, of themselves, a health hazard, but the toxins they produce (called cyanotoxins) are. For this reason it is recommended that public health management be focussed on the cyanotoxins, and that cyanobacteria in drinking-water be managed as a chemical problem (Chorus and Bartram, 1999). The presence of cyanobacteria can be regarded as a trigger for monitoring for cyanotoxins. Cyanobacteria can also cause taste and odour problems, see Chapter 18, and geosmin, 2-methyl isoborneol and  $\beta$ -cyclocitral in the organic chemicals datasheets. Cyanobacteria inhabit all natural waters and generally only become a problem only when they increase to excessive numbers (water blooms). Why population densities reach bloom proportions is a subject for much discussion and research (eg, Smith and Lester 2006; Oliver et al 2012).

Concern about the effects of cyanobacteria on human health has grown in many countries in recent years for a variety of reasons. These include cases of poisoning attributed to toxic cyanobacteria and awareness of contamination of water sources (especially lakes) resulting in increased cyanobacterial growth. Cyanobacteria also continue to attract attention in part because of well-publicised incidents of animal poisoning. Outbreaks of human poisoning attributed to toxic cyanobacteria have been reported in several countries including Australia, following exposure of individuals to

contaminated drinking water, and the UK, where army recruits were exposed while swimming and canoeing. However, the only proven human fatalities associated with cyanobacteria and their toxins have occurred in Brazil (see section 9.1.2).

## 9.1.1 Algal bloom development

Cyanobacteria are members of the community of phytoplankton (which means small free floating plants; however cyanobacteria are actually bacteria) and the bottom-dwelling organisms living on the surface of the sediments and stones in most water-bodies. The right combination of environmental conditions, particularly elevated nutrient concentrations, may cause their excessive growth (bloom formation), leading to blue, brown or greenish discolouration of water through the high population density of suspended cells, and to the formation of surface scums. Such accumulations of cells may lead to high toxin concentrations. Because the conditions that lead to excessive growth of planktonic cyanobacteria (free-floating in the water column) and benthic cyanobacteria (attached to the substrate of rivers, lakes and reservoirs) can be quite different, we discuss each individually in the following section.

### 9.1.1.1 Key Drivers of Planktonic Cyanobacteria Growth

Cyanobacteria have very low requirements for growth as they primarily produce their energy from sunlight. Planktonic cyanobacteria grow floating in the water column of lakes and reservoirs. When there are shifts in the abundance of limiting factors (light, temperature, nutrients) cyanobacteria are able to flourish and blooms occur. Because some planktonic cyanobacteria also possess strategies to overcome growth-limiting factors (eg, the ability to control buoyancy, store nitrogen and phosphorous, and fix atmospheric nitrogen into usable forms), they are often able to grow under less-ideal conditions. Under non-ideal conditions, planktonic cyanobacteria are also able to lay dormant in the sediment of lakes and reservoirs until conditions change. Whilst some cyanobacteria produce specialised cells (ie, akinetes) that are able to lay dormant for hundreds of years, other cyanobacteria will over-winter in the sediment until water conditions are more ideal for growth in the following year.

#### a) Eutrophication

High concentrations of nutrients, usually phosphorus and nitrogen, can cause increases in natural biological production in waterways. These conditions can result in visible cyanobacterial or algal blooms and surface scums. The concentrations of phosphorus in the water often limit the growth of planktonic cyanobacteria, but in a substantial number of lakes in New Zealand, the dissolved nitrogen concentrations are said to be the limiting factor despite some cyanobacteria being able to fix nitrogen.

Some lakes are naturally eutrophic, but in most the excess nutrient input is of anthropogenic origin, resulting from wastewater discharges or run-off from fertilisers and manure spread on agricultural areas. Where nutrient concentrations in water bodies are naturally low, or have been lowered by remedial actions to limit nutrient run-off, high cyanobacterial populations may still develop where species that are able to fix atmospheric nitrogen are present or where sediment previously introduced into

lakes provides a nutrient source that is liberated during times of stratification. The relationship between nutrient concentrations and the predominance of different microorganisms can be quite complex; for example, cyanobacteria grow in Antarctica and the high slopes of Mt Ruapehu.

Understanding the conditions that promote the growth of cyanobacteria in water bodies is useful for predicting whether cyanobacterial problems are likely to occur. A fundamental basis for the growth of planktonic cyanobacteria is the concentration of total phosphorus, as the total amount of phosphorus in the system limits the total amount of biomass that can be produced. Water temperature is also an important factor for assessing the potential for cyanobacterial growth, as shown in Table 9.1. Data on additional factors, such as chlorophyll *a*, thermal stratification, local weather conditions influencing stratification and concentrations of nitrogen, can improve the assessment.

**Table 9.1: Example assessment of the potential for high biomass of planktonic cyanobacteria based on environmental conditions <sup>a</sup>**

| Indicator                                   | Very low               | Potential for high biomass of planktonic cyanobacteria (blooms) |          |          | Very high |
|---|------------------------|---|----------|----------|-----------|
| Total phosphorus (µg/L)                     | <10                    | 12–25   | >25–50   | >50–100  | >100      |
| Water residence time                        | River, visible current | <1 month  | <1 month | <1 month | ≥1 month  |
| pH  | <5–6                   | <6–7  | <6–7     | <6–7     | >7        |
| Temperature (°C)                            | <10                    | 10–<15  | 15–<20   | 20–<25   | ≥25       |
| Secchi disc during cyanobacteria season (m) | ≥2                     | <2–1  | <1–0.5   | <1–0.5   | <0.5      |

<sup>a</sup> The higher the number of these conditions that are fulfilled, the greater the potential for high biomass. This table has been taken from WHO (2015), which was adapted from Umweltbundesamt (2014).

## b) Temperature

Provided nutrient and light levels do not limit planktonic cyanobacteria growth, blooms will persist in waters with temperatures between 15 and 30°C (and pH levels between 6 and 9), with maximum growth rates occurring at temperatures in excess of 25°C.

## d) Light

The intensity of daylight needed for optimal growth depends on the species of cyanobacteria. Extended exposure to moderate to high light intensities is lethal for many species, although species that form surface blooms are tolerant of these conditions. Maximum growth results from intermittent exposure to high light intensities. Cyanobacteria require little energy to function. As a consequence, they are able to grow at faster rates than other phytoplanktonic organisms at low light intensities.

## e) Alkalinity and pH

Alkalinity and pH determine the chemical speciation of inorganic carbon, such as carbonate, bicarbonate and carbon dioxide. Low carbon dioxide concentrations favour the growth of several cyanobacterial species. Hence, water conditions such as low alkalinity and hardness and the consumption of carbon dioxide by algae during

photosynthesis, increasing the pH, give cyanobacteria a competitive advantage (Health Canada 2000, edited 2002).

#### f) Atmospheric CO<sub>2</sub>

Analysis of cyanobacterial pigments in sediment cores from over 100 northern hemisphere temperate and sub-arctic lakes revealed that the abundance of cyanobacteria had increased in nearly 60 percent of lakes over the last 200 years, possibly due to increased industrialisation. This increase was disproportionate compared to other phytoplankton, and the rate of cyanobacterial increase became more rapid after about 1945, coinciding with an increase in rates of fertiliser application and the introduction of phosphorus-containing detergents, and possibly the growth in coal and gas power stations. Increasing atmospheric concentrations of CO<sub>2</sub> and increased diffusion of CO<sub>2</sub> into water bodies was initially thought to be disadvantageous to cyanobacteria. However, recent research has shown that the genetic diversity of CO<sub>2</sub> concentrating mechanisms among cyanobacterial strains and species, and the physiological flexibility of these systems allows rapid adaptation of cyanobacterial populations to increases in atmospheric CO<sub>2</sub> concentrations. Mathematical models and laboratory experiments both support the view that rising atmospheric CO<sub>2</sub> concentrations are likely to intensify cyanobacterial blooms in eutrophic and hypertrophic waters. From Health Stream, accessed July 2018)

#### g) Gas vesicles

Many planktonic cyanobacteria contain gas vesicles that can be used to control buoyancy. Through the filling and collapse of gas vesicles, and the fixation of carbohydrates from photosynthesis some cyanobacteria can control their movement to optimum depths in the water column. For example, filling the vesicles with gas allows cyanobacteria to rise towards the surface where light is more abundant, and the collapse of gas vesicles and storage of heavy carbohydrates allows the organism to sink down through thermal gradients to reach nutrients in the cooler layers.

#### h) Growth rates

Cyanobacteria have slow growth rates compared with other phytoplankton, which means they require long retention times in still water bodies for blooms to form. Turbulence and high flows are unfavourable to the growth of cyanobacteria, as they interfere with their ability to maintain optimum depths in the water column.

### 9.1.1.2 Key Drivers of Benthic Cyanobacteria Growth

Blooms of benthic (attached or mat-forming) cyanobacteria can occur in rivers and in lakes and reservoirs where light can penetrate to the substrate. In rivers, benthic cyanobacterial mats are usually observed during periods of stable (but not necessarily) low flow. Benthic cyanobacteria are widespread throughout New Zealand rivers and are found in a wide range of water quality conditions, including oligotrophic waters (waters with low nutrients). The potential for these cyanobacteria to develop in waters with low nutrients requires vigilance from drinking-water operators using river water. The most common mat-forming benthic cyanobacterial genus in New Zealand is *Microcoleus* (previously *Phormidium*). During stable flow conditions *Microcoleus* mats can



proliferate, at times forming expansive black/brown leathery mats across large expanses of river substrate. Flow conditions, substrate, water chemistry and species composition can influence the macroscopic appearance of benthic cyanobacterial mats and at times they may be confused easily with other algal groups; eg, diatoms, green algae. Microscopic confirmation should be undertaken to confirm whether cyanobacteria are the dominant component of attached communities. These mats also commonly detach from river/ lake substrates and float on the water surface, forming floating rafts in rivers, lakes and reservoirs. This is because under certain environmental conditions, or as mats become thicker (and bubbles of oxygen gas become entrapped within them), they will detach from the substrate and may accumulate along river edges. During these events the risk to human and animal health is higher due to accessibility of toxins to river users and bankside abstractions. Additionally, during these periods the cells are likely to be lysing and releasing toxins.

### a) Nutrient availability

The majority of data on nutrient drivers for benthic cyanobacteria growth is from *Microcoleus* and *Phormidium*. These cyanobacteria generally follow an accrual cycle consisting of mat initiation through colonisation or regrowth of relic populations, its subsequent growth via lateral expansion (which could be driven by cell motility, cell division, and biomass accrual) and lastly, physical or natural detachment of mats (McAllister et al. 2016). After colonisation, the balance of growth- and loss-promoting factors determines the length of the accrual cycle, the size and persistence of the accrual. Because the mats become complex micro-environments once established, nutrients from the water column are not necessarily limiting for these benthic cyanobacteria following the colonisation phase and establishment of the benthic mat.

The nutrient conditions under which *Microcoleus autumnalis* and closely-related *Phormidium* species, reach high percentage cover are broad. For example, McAllister et al. (2018a) and Wood et al. (2017) found that proliferations occurred at nitrogen concentrations ranging from 0.02 and 0.9 mg/L. Dissolved reactive phosphorous (DRP) concentrations below 0.01 mg/L were initially thought to favour *Microcoleus autumnalis* to proliferate. However, recent research suggests a slightly higher upper limit of 0.05 mg/L (McAllister et al. 2018a).

Wood et al. (2015) showed that conditions within *Microcoleus autumnalis* mats differ significantly from the overlying water column, including the development of high pH (> 9) during the day (due to photosynthetic depletion of bicarbonate) and low dissolved oxygen (< 4 mg/L) concentrations at night (due to respiration). These conditions facilitate the release of DRP bound to sediment which partially explains the propensity of proliferations to form under low DRP conditions. For this reason, sediment inputs into freshwater systems may promote the growth of *Microcoleus* blooms.

What has also become clear over the last decade of research into benthic *Microcoleus*, is that site specific differences are very apparent. This has been demonstrated in studies conducted in the Manawatu catchment (Wood et al 2014), the Wellington region (GRWC 2016) and in the international studies described above. Cawthron Institute is developing a model which provides relatively realistic real-time estimates of *Microcoleus* cover, however, because of the site-specific differences mentioned above the models need to be calibrated using site-specific data (Cawthron 2018).

## b) Temperature

There is general agreement in the literature that high temperatures are correlated with increased *Microcoleus autumnalis* and *Phormidium* cover (Heath et al. 2011, Schneider 2015, Wood et al. 2017, Echenique-Subiabre et al. 2018a). Heath et al. (2011) showed that temperatures >14 °C were correlated with increased cover and Echenique-Subiabre et al. (2018a) found that cover was highest under temperatures exceeding 16 °C. During summer when water temperatures are warmer, there may also be fewer occasions of higher flow flushing away any build-up of benthic micro-organisms (eg, as discussed in the following subsection and in Heath and Wood, 2010). Global warming will extend the duration of 'summer temperatures' and cause longer periods with the absence of 'flushing flows'.

## c) Flows and Flushing

High velocity has been identified in many different studies as having a positive influence on *Microcoleus autumnalis* and *Phormidium* growth (Hart et al. 2013, Heath et al. 2015, McAllister et al. 2019). Heath et al. (2015) and Hart et al. (2013) highlighted that *Microcoleus autumnalis* was dominant at velocities greater than 0.4 m/s in the Hutt and Waipara Rivers (New Zealand), respectively. Similarly, in experimental stream mesocosms McAllister et al. (2018b) found that an increase of 0.1 m/s in velocity resulted in higher biomass accrual and McAllister et al. (2019) found that expansion and biomass accrual was greatest in run habitats (near-bed velocities of 0.25–0.45 m/s). Velocity is likely to influence growth in complex ways, including through influencing the effectiveness of grazers and through reducing the boundary layer, thus allowing greater diffusion of solutes in and out of the mat matrix.

Flushing flows were identified as the key variable regulating *Microcoleus* abundance (GRWR, 2016). However, it remains unclear how the length of the accrual (growth) period between flushing flows affects *Microcoleus* growth. Longer accrual periods between large flushes (>9x median flow events) were associated with a greater magnitude of *Microcoleus* growth. However, there was no relationship between *Microcoleus* growth and accrual period length for smaller (and more generically used) >3x median flushing flow events. It is likely that the magnitude of flushing flow required to remove *Microcoleus* proliferations from the riverbed varies greatly depending on the physical characteristics of each river, making it difficult to assess the relationship between flushing flow frequency and *Microcoleus* growth. In the Hutt River, analysis of GWRC's long-term flow record at Taita Gorge (from 1979 to 2013) revealed that there has been no significant change in the annual frequency of flushing flows and average accrual period. While flushing flow frequency is likely to be an important driver of *Microcoleus* growth in rivers where it occurs, it did not explain why some rivers in the Wellington Region experience *Microcoleus* blooms and others do not.

## d) Light

As benthic cyanobacteria require light in order to grow, light penetration limits the depth they can grow in lakes and reservoirs. Because cyanobacteria are very efficient at harvesting light, this may be at depths greater than what can be visually observed from the surface.

## 9.1.2 Health significance of cyanotoxins

Cyanobacteria do not multiply within the human body and are therefore not infectious. Many cyanobacteria, however, produce potent toxins. Exposure to these toxins, either in the cells or the water, through ingestion, inhalation or through contact with the skin, is therefore the primary health concern associated with cyanobacteria.

Cyanotoxins belong to a diverse group of chemical substances, each of which shows specific toxic mechanisms in vertebrates. Some cyanotoxins are strong neurotoxins (anatoxin-a, anatoxin-a(S), saxitoxins), others are primarily toxic to the liver (microcystins, nodularin and cylindrospermopsin) and yet others (such as the endotoxins) appear to cause health impairments (such as gastroenteritis), which are poorly understood. Assignment of health effects to specific species or toxins is often difficult because several cyanobacterial species may co-exist in a water body. Global data show that hepatotoxins (those causing liver damage) occur most frequently, although there have been blooms producing neurotoxins that have led to animal deaths. The effect of different neurotoxins or hepatotoxins occurring simultaneously is highly likely to be additive. WHO (2017a) discusses the effects of chemical mixtures and includes a microcystin case study – some of which has been added to this chapter as Appendix 2.

Not all strains of cyanobacteria carry the genes required for toxin production, and the factors which trigger toxin production in toxin-capable strains are not well understood. Cyanobacterial blooms often contain a mixture of toxin producing and non-producing strains, and their relative proportions may vary over the duration of a bloom. Currently, it is not possible to reliably predict whether a bloom that includes toxin-capable strains will produce toxin or how much may be produced as multiple cyanobacterial species may also be present in a bloom, with their proportions varying over time. In addition to toxic metabolites, many cyanobacterial species also produce other problematic metabolites that may adversely affect the taste and odour of water even at very low concentrations (Health Stream, accessed July 2018).

Generally, toxicity is not a trait specific for certain species; rather, most species comprise toxic and non-toxic strains. For *Microcystis* (and other microcystin-producing cyanobacteria), it has been shown that toxicity for a strain depends on whether or not it contains the gene for microcystin production (Rouhiainen et al 1995; Dittmann et al 1996) and that field populations are a mixture of both genotypes with and without this gene (Kurmayer et al 2002). Experience with cyanobacterial cultures also shows that microcystin production is a fairly constant trait of a given strain or genotype, only somewhat modified by environmental conditions (see various contributions in Chorus 2001). While conditions leading to cyanobacterial proliferation are well understood (the physiological or biochemical function of toxins for the cyanobacteria is the subject of many hypotheses: Chorus and Bartram 1999), the factors leading to the dominance of toxic strains over non-toxic ones are not. See WHO (2003) for reference details.

Table 2.3 of the DWSNZ lists provisional maximum acceptable values (PMAVs) for some cyanotoxins. Refer to Chapter 1: Introduction, section 1.6.2 for information about MAVs. Chorus (2012) collated cyanotoxin standards and regulations from several countries around the world. USEPA (2015a) provides a link to the Drinking Water Health Advisory for the Cyanobacterial Toxin Cylindrospermopsin; Drinking Water Health Advisory for the Cyanobacterial Microcystin Toxins; and the Health Effects Support Documents for Anatoxin-A, Cylindrospermopsin and Microcystins. See individual datasheets.

The effects of cyanotoxins can be both acute and chronic, and protection against both long-term exposure, and short-term exposure, is required. While some short-term exposure can lead to health effects from which recovery is complete, it can also result in long-term damage to target organs.

Acute effects:

- dermal exposure, particularly if cells are accumulated under swimsuits and wet suits, may lead to skin irritations and allergic reactions (Pilotto et al 1997)
- symptoms involving irritation of internal and external mucous membranes; ie, gastro-intestinal or respiratory organs, eyes, ears, mouth and throat are also reported
- exposure to cell material of any cyanobacteria can cause illness such as fever, probably evoked by lipopolysaccharides contained in the cell wall of cyanobacteria (Keleti et al 1979; Lippy and Erb 1976)
- neurotoxins administered in mouse studies led to rapid respiratory arrest
- extensive kidney and liver damage following exposure to cyanotoxins has been reported (eg, Hawkins et al 1985)
- severe acute effects on human health appear to be rare, the only fatalities associated with cyanobacteria or their toxins having been reported in Brazil. In 1988 a new impoundment in Brazil developed an immense cyanobacterial bloom and there followed approximately 2,000 gastroenteritis cases, 88 of which resulted in death. Cyanobacterial toxins were the likely cause (Teixera et al 1993), with contamination by heavy metals and pathogens ruled out. In 1996 (Jochimsen et al 1998; Carmichael et al 2001; Azavedo et al 2002), over 100 kidney patients developed liver disease and over 50 deaths were attributed to dialysis with water containing cyanobacterial toxins (Jochimsen et al).

Chronic effects:

- the key concerns of chronic effects associated with cyanotoxins are liver and kidney damage as well as tumour promotion, but there is a lack of clinical studies relating to chronic exposure (such as tumour promotion, eg, Ueno et al 1996, and liver damage), and this hinders the determination of safe concentrations for long-term exposure
- animal experiments have shown chronic liver injury from continuing oral exposure to cyanotoxins.

Members of the population at greatest risk when exposed to cyanotoxins are children (because their water intake:bodyweight ratio is higher than that of adults), and those who already have damaged organs that may be the target of the toxins. Recreational exposure is the most probable pathway for ingestion of a high dose of microcystins or nodularins. Any water sport that involves immersion of the head invariably leads to some oral uptake or aspiration (IARC 2010).

The health risks associated with cyanotoxins are greatest when cyanobacterial cell concentrations are high due to excessive growth (ie, bloom events). The highest cyanotoxin concentrations are usually contained within the cells (intracellular), and toxin concentrations dissolved in the water (extracellular toxins) are rarely reported above a few µg/L (Chorus and Bartram 1999). While the risks associated with cyanobacteria may rise and fall with the development and decay of bloom events, in some countries cyanobacteria may be present in water bodies over extended periods of time which results in continued exposure to subacute concentrations (Ressom et al 1994; Hitzfeld et al 2000), and the possibility of chronic health effects.

When a cyanobacterial bloom develops in a water body, exposure of those using the water for recreational purposes to hazardously high cyanotoxin concentrations will be most likely where cell densities are high, particularly in surface scums. Wind-driven accumulations of surface scums can result in toxin concentrations increasing by a factor of 1,000 or more. Such situations can change within very short time periods (within hours). Children playing in shallow zones along the shore where scums accumulate are particularly at a risk.

The death of cyanobacterial cells, through the organism reaching the end of its lifecycle or through measures taken to control blooms, can result in higher than normal concentrations of extracellular toxin. Episodes of acute sickness have been reported after treatment of cyanobacterial blooms with copper sulphate to control the bloom, which then resulted in release of cyanotoxins into the water and breakthrough of dissolved toxins into drinking-water supplies.

It is preferable to control the health hazards associated with cyanotoxins by reducing the likelihood of bloom formation, rather than having to remove the cyanobacteria and any extracellular toxin present from the water. Monitoring of source water for evidence of the start of bloom development, or the potential for bloom formation, overcomes difficulties such as inadequate analytical methods associated with the measurement of cyanotoxins themselves.

### 9.1.3 Taste and odour caused by cyanobacteria

Cyanobacteria have, for a long time, been recognised as a nuisance in the drinking-water industry because of the ability of several taxa to produce earthy and musty smelling compounds, notably geosmin and 2-methyl isoborneol (2-MIB), for which the odour detection thresholds of less than 10 ng/L are remarkably low amongst sensitive individuals. β-Cyclocitral is formed by cyanobacteria in reservoirs and rivers as well.

The cyanobacterial genera that are known to produce geosmin are *Dolichospermum* (previously *Anabaena*), *Aphanizomenon*, *Lyngbya*, *Microcystis*, *Oscillatoria*,

*Phormidium/Microcoleus*, *Schizothrix* and *Symploca* (Perrson 1983, cited in Chorus and Bartram 1999). All of these (except *Symploca*) are also known to include toxin-forming species and strains. Because of this, the possibility of using odour compounds as an early warning for the development of toxin-producing cyanobacterial blooms has been considered. However, there is no evidence of a correlation between toxin production and the production of taste- and odour-producing compounds that would provide a warning of toxicity. It is very unlikely that the production of taste and odour compounds is biochemically connected to the production of cyanotoxins (Chorus and Bartram 1999).

## 9.1.4 Occurrence of toxic cyanobacteria internationally and in New Zealand

Not all cyanobacteria that have been found to produce toxins have been identified in New Zealand. Table 9.2 lists, in alphabetical order, some of the species found internationally to produce toxins and the nature of the toxin produced. This list is continually increasing, and should not be regarded as definitive. It is provided as a guide to those trying to determine whether a cyanobacterial species found in a waterbody may be a toxin producer. Cyanotoxins that have been shown to be produced by certain cyanobacteria in New Zealand are indicated in bold type.

**Table 9.2:** Summary of known toxin-producing cyanobacteria identified internationally by isolation of cultured strains. Species in **bold type** are known to produce the associated toxin (also in bold type) in New Zealand.

| Cyanobacteria Genus/Species             | Cyanotoxin/s                                |
|---|---|
| <i>Anabaena</i> sp.                     | Microcystins                                |
| <i>Anabaenopsis millenii</i>            | Microcystins                                |
| <i>Annamia toxica</i>                   | Microcystins                                |
| <i>Aphanizomenon flos-aquae</i>         | Anatoxin-a, Cylindrospermopsins, Saxitoxins |
| <i>Aphanizomenon gracile</i>            | Anatoxin-a, Cylindrospermopsins, Saxitoxins |
| <i>Chrysoosporum ovalisporum</i>        | Cylindrospermopsins                         |
| <i>Aphanizomenon</i> sp.                | Anatoxin-a, Cylindrospermopsins, Saxitoxins |
| <i>Aphanocapsa cumulus</i>              | Microcystins                                |
| <i>Arthrospira fusiformis</i>           | Anatoxin-a,                                 |
| <i>Chrysoosporum ovalisporum</i>        | Cylindrospermopsins                         |
| <i>Coelosphaerium kuetzingianum</i>     | Microcystins                                |
| <b><i>Cuspidothrix issatchenkoi</i></b> | <b>Anatoxin-a</b>                           |
| <i>Cylindrospermum stagnale</i>         | Saxitoxins                                  |
| <i>Cylindrospermum</i> sp.              | Anatoxin-a, Saxitoxins                      |
| <i>Dolichospermum circinale</i>         | Anatoxin-a                                  |
| <i>Dolichospermum flos-aquae</i>        | Anatoxin-a, Anatoxin-a(S), Microcystins     |
| <i>Dolichospermum lapponica</i>         | Cylindrospermopsins                         |

| <b>Cyanobacteria Genus/Species</b>        | <b>Cyanotoxin/s</b>  |
|---|--|
| <b><i>Dolichospermum lemmermannii</i></b> | <b>Anatoxin-a, Anatoxin-a(S), Microcystins</b>               |
| <i>Dolichospermum</i> sp.                 | Anatoxin-a, Anatoxin-a(S), Cylindrospermopsins, Microcystins |
| <i>Dolichospermum spiroides</i>           | Anatoxin-a(S)  |
| <i>Dolichospermum subcylindrica</i>       | Microcystins   |
| <i>Dolichospermum ucrainica</i>           | Microcystins   |
| <i>Dolichospermum variabilis</i>          | Microcystins   |
| <i>Fischerella</i> sp.                    | Microcystins   |
| <i>Geitlerinema amphibium</i>             | Saxitoxins   |
| <i>Geitlerinema carotinum</i>             | Anatoxin-a, Microcystins                                     |
| <i>Geitlerinema lemmermannii</i>          | Saxitoxins   |
| <i>Geitlerinema splendidum</i>            | Anatoxin-a, Microcystins                                     |
| <i>Gloeotrichia natans</i>                | Microcystins   |
| <i>Hapalosiphon hibernicus</i>            | Microcystins   |
| <i>Heteroleibleinia kuetzingii</i>        | Microcystins   |
| <i>Iningainema pulvinus</i>               | Nodularin  |
| <i>Leptolyngbya</i> sp.                   | Microcystins   |
| <i>Limnothrix mirabilis</i>               | Microcystins   |
| <b><i>Microcoleus autumnalis</i></b>      | <b>Anatoxins</b>   |
| <b><i>Microcoleus</i> sp.</b>             | <b>Anatoxins, Microcystins,</b>                              |
| <b><i>Microcystis aeruginosa</i></b>      | <b>Microcystins, Saxitoxins</b>                              |
| <i>Microcystis botrys</i>                 | Microcystins   |
| <i>Microcystis flos-aquae</i>             | Microcystins   |
| <i>Microcystis ichthyoblabe</i>           | Microcystins   |
| <i>Microcystis novacekii</i>              | Microcystins   |
| <i>Microcystis panniformis</i>            | Microcystins   |
| <b><i>Microcystis</i> sp.</b>             | Anatoxin-a, <b>Microcystins, Saxitoxins</b>                  |
| <i>Microcystis viridis</i>                | Microcystins   |
| <i>Microcystis wesenbergii</i>            | Microcystins   |
| <i>Microseria wollei</i>                  | Cylindrospermopsins, Saxitoxins                              |
| <b><i>Nodularia spumigena</i></b>         | <b>Nodularin</b>   |
| <i>Nodularia sphaerocarpa</i>             | Nodularin  |
| <i>Nostoc commune</i>                     | Microcystins   |
| <i>Nostoc linckia</i>                     | Microcystins   |
| <i>Nostoc muscurum</i>                    | Microcystins   |
| <b><i>Nostoc</i> sp.</b>                  | <b>Microcystins, Nodularin</b>                               |
| <i>Nostoc spongiaeforme</i>               | Microcystins   |

| <b>Cyanobacteria Genus/Species</b>                                  | <b>Cyanotoxin/s</b>                                  |
|---|--|
| <i>Oscillatoria agardhii</i>  | Microcystins   |
| <i>Oscillatoria limnetica</i>                                       | Anatoxin-a   |
| <i>Oscillatoria limosa</i>  | Microcystins   |
| <i>Oscillatoria margaritifera</i>                                   | Microcystins   |
| <b><i>Oscillatoria</i> sp.</b>                                      | <b>Anatoxin-a, Microcystins</b>                      |
| <i>Phormidium ambiguum</i>  | Cylindrospermopsins                                  |
| <i>Phormidium corium</i>  | Microcystins   |
| <i>Phormidium favosum</i>   | Anatoxin-a   |
| <i>Phormidium</i> sp.   | Anatoxin-a, Microcystins                             |
| <i>Phormidium splendidum</i> (Syn. <i>Geitlerinema splendidum</i> ) | Microcystins   |
| <i>Phormidium uncinatum</i>   | Anatoxin-a, Microcystins, Saxitoxins                 |
| <i>Planktothrix agardhii</i>  | Microcystins   |
| <i>Planktothrix formosa</i>   | Anatoxins  |
| <i>Planktothrix rubescens</i>                                       | Microcystins   |
| <b><i>Planktothrix</i> sp.</b>                                      | <b>Anatoxins, Microcystins, Saxitoxins</b>           |
| <i>Plectonema boryanum</i>  | Microcystins   |
| <i>Pseudoanabaena frigida</i>                                       | Microcystins   |
| <i>Pseudocapsa dubia</i>  | Microcystins   |
| <i>Radiocystis fernandoi</i>  | Microcystins   |
| <i>Raphidiopsis brookii</i>   | Saxitoxins   |
| <i>Raphidiopsis curvata</i>   | Cylindrospermopsins                                  |
| <i>Raphidiopsis mediterranea</i>                                    | Anatoxins, Cylindrospermopsins                       |
| <b><i>Raphidiopsis raciborskii</i></b>                              | <b>Cylindrospermopsins, Saxitoxins, Microcystins</b> |
| <i>Rivularia biasoletiana</i>                                       | Microcystins   |
| <i>Rivularia haematites</i>   | Microcystins   |
| <i>Schizothrix rivularianum</i>                                     | Microcystins   |
| <b><i>Scytonema</i> cf. <i>crispum</i></b>                          | <b>Saxitoxins</b>                                    |
| <i>Scytonema drilosiphon</i>  | Microcystins   |
| <i>Snowella</i> sp.   | Microcystins   |
| <i>Synechococcus lividus</i>  | Microcystins   |
| <i>Synechocystis</i> sp.  | Microcystins   |
| <i>Tolypothrix distorta</i>   | Microcystins   |
| <i>Tychonema burrellyi</i>  | Anatoxins  |
| <i>Umezakia natans</i>  | Cylindrospermopsins                                  |
| <i>Woronichinia</i> sp.   | Microcystins   |



| Cyanobacteria Genus/Species   | Cyanotoxin/s |
|---|--------------|
| Notes: This is a compilation of worldwide information. New toxic species continue to be identified, and all cyanobacteria should be regarded as potentially toxic until proven otherwise. |              |

Most environmental benthic samples or mats consist of multiple species. A recent report (Cawthron 2015) lists the six known toxin-producing benthic cyanobacterial species in New Zealand, and their cyanotoxins:

- *Nostoc commune*                      microcystins
- *Oscillatoria* sp.                      anatoxin-a, microcystins, homoanatoxin-a
- *Microcoleus* sp.                      dihydroanatoxin-a, dihydrohomoanatoxin-a
- *Planktothrix* sp.                      microcystins
- *Scytonema* cf. *crispum*              saxitoxins
- Unknown species                      nodularin

Two reports of cyanobacterial data collected from New Zealand waterways; Podivinsky and Williamson (2009), Nokes (2010), demonstrate that there is the potential for cyanotoxins to pose a risk. A key finding (Nokes 2010) was:

Where substantial blooms develop, toxin concentrations readily exceed provisional maximum acceptable values (PMAV) by a factor of 10, and in some instances by four-to-five orders of magnitude. Cyanobacteria are an extremely dangerous hazard in drinking and recreational waters because of the speed at which cyanobacterial toxin producers multiply, the concentrations toxins can reach, the difficulty in removing toxins from the water, and the severity of the health effects that can be associated with them. The most effective strategy for defence against them is to take measures to stop blooms developing.

## 9.2 Risk management

### 9.2.1 Assessment of risk

Assessing the risk posed by cyanobacterial toxins, or the potential for development of cyanobacterial blooms, and linking this to effective measures for the protection of public health within available resources, is complex.

Ideally, situation assessments would be proactive (ie, carried out with the intention of preventing the bloom from developing) enabling water managers to:

- determine whether contingency planning is required and
- initiate long-term action, such as pollution control to minimise bloom formation.

However, at times it may be reactive (ie, carried out as a response to the development of the bloom), such as assisting in interpretation of specific local events or conditions to provide information on which to base emergency or incident responses. In this

context, Water Research Foundation (WRF, 2018) developed a toolkit for effective cyanotoxin communications as part of a risk management plan.

The type of information that could be used to assess the risk due to cyanobacteria is summarised in Table 9.3.

**Table 9.3: Information that may help in situation assessment and management**

| Observation   | Sources of information  | Management options   |
|---|---|--|
| Potential for bloom formation   | Water quality monitoring data (nutrients, temperature, etc)   | Basis for proactive management (ie, actions to stop conditions developing that will allow bloom formation)         |
| History of bloom formation  | Cyanobacterial blooms may follow marked seasonal and annual patterns  | Can inform proactive management  |
| Monitoring of cyanobacteria and/or cyanotoxins                        | Turbidity, discolouration, odour, cell microscopic identification, cell counts and toxin analysis provide increasingly reliable information               | Possible basis for proactive management provided cell counts are monitored regularly                               |
| Scum scouting   | In areas of high public interest the general public and untrained agency staff may play a role in identifying and reporting obvious hazards such as scums | Possible only during event and enables only reactive management (ie, taking actions after the bloom has developed) |
| Reporting of animal deaths and human illness                          | Requires both the willingness of the community to assist in providing the data and a mechanism for data collection which may not exist                    | Possible only during event and informs only reactive management  |
| Epidemiological detection of disease patterns in the human population | Requires both effective reporting and large-scale effects before detection likely   | Normally well after an event; can inform future management strategies  |

From Chorus and Bartram 1999.

A diagram to rapidly assess the level of risk to health presented by a cyanobacterial bloom, by considering the treatment processes in place, is given in Figure 9.1, which assumes that treatment processes are working properly, and that they are capable of treating the concentrations of toxin or cell concentrations in the raw water. If either of these assumptions is invalid, the absolute levels of risk may be markedly different.

**Figure 9.1: Rapid assessment of the level of risk posed by toxic cyanobacteria in a drinking water source**

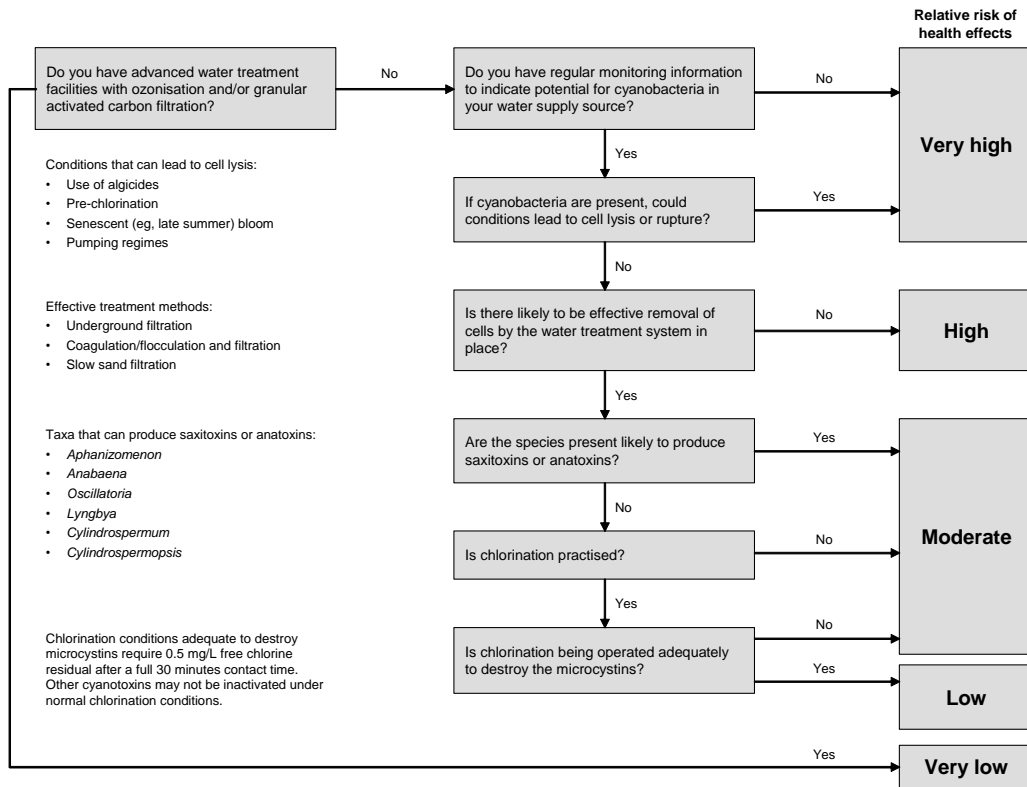

Modified from WHO 1997, and Chorus and Bartram 1999.

USEPA (2015) is intended to assist water suppliers that choose to develop system-specific plans for evaluating their source waters for vulnerability to contamination by microcystins and cylindrospermopsin. It could also serve as a model for addressing potential concerns from other cyanotoxins in the future. The document provides a stepwise approach to inform their decisions on whether and how to monitor and (or) treat for microcystins and cylindrospermopsin and when and how to communicate with stakeholders. The approach includes the following steps:

1. Step 1 involves conducting a system-specific evaluation for vulnerability to blooms.
2. Step 2 suggests activities for preparing and observing for potential blooms.
3. Step 3 describes monitoring activities to determine whether cyanotoxins are present in the raw water, and recommended communication and treatment activities if cyanotoxins are found in the raw water.
4. Step 4 describes monitoring activities to determine whether cyanotoxins are present in finished water and recommended communication and treatment activities if cyanotoxins are found.
5. Step 5 describes continued finished water monitoring (confirming the initial finished water sample in Step 4), treatment and communication activities if cyanotoxins are found in the finished water above acceptable concentrations.

Chorus (2005) and Burch (2008) have summarised current approaches to cyanotoxin risk assessment, risk management and regulations in different countries. The approach taken by different countries varies from informal arrangements where information is gathered by different organisations and collated by one group for non-specific

publication, to formal guidelines and regulations. Most countries with specified values use the WHO tolerable daily intake (TDI) for microcystin-LR with slight variation (from 0.84 to 1.5 µg per L). Monitoring and trigger points for cyanotoxin testing (rather than cyanobacteria testing) and for actions to neutralise cyanotoxins varies considerably between countries. For example, Brazil has an upper tolerance of 10,000 cells per mL or 1.0 mm<sup>3</sup> biovolume, whereas Australia has an upper limit of 6,500 cells per mL, with cyanotoxin testing coming in below these levels.

An attempt to predict the vulnerability of reservoirs in Australia to cyanobacterial blooms has resulted in a vulnerability index (Leigh 2010). The analysis suggests that strong links exist between the physical environmental of dammed river systems, their physicochemical characteristics and algal ecology. The vulnerability index used parameters which satisfied the following four conditions:

- 1 correlation with water quality was well established in the literature
- 2 parameters were easily calculated from readily available data on reservoir or catchment characteristics
- 3 parameters were not strongly correlated with each other
- 4 parameters were relatively static or predictable though time so that the index was unaffected by substantial spatial and temporal variation.

The resources mentioned above may be useful for strategies for assessing the risk posed by cyanobacteria in a specific water supply and developing a cyanobacteria management plan.

## 9.3 Monitoring

The design of monitoring programmes for cyanobacteria and their toxins is more challenging than programmes for other pathogens or chemical determinands. Factors that contribute to the added complexity are their ability to grow in open waters, not necessarily near a particular source; scums of cyanobacteria may be shifted and concentrated by wind; toxins may be contained in their cells, or dissolved in the water, be absent, or develop very quickly.

Monitoring programmes for these organisms need to be tailored to the characteristics of each body of water. They also need to be flexible to take account of changes in the risk the toxins present with time and location. Collection of historical information regarding blooms and growth conditions, and identification of patterns of cyanobacterial growth can be used to help focus the monitoring programme on critical periods and locations in the water body of interest.

WRF (2016) discusses methods for monitoring cyanobacterial development, including:

- Chlorophyll *a* is common parameter that can be measured and used to indicate the presence of algae. It measures algal biomass fairly accurately and can be analysed using probes or relatively simple laboratory equipment. One shortcoming of chlorophyll *a* as an indicator of cyanobacteria growth is that it is found in all algae, not just cyanobacteria.

- Buoy monitors are becoming an increasingly popular way to collect real-time water quality data. Sensors are available that measure phycocyanin (a pigment which is largely unique to cyanobacteria) and chlorophyll *a*. Real-time chlorophyll *a* and phycocyanin measurements are probably most helpful if the water utility considers them in terms of relative changes, rather than considers them as stand-alone measurements.
- Satellite photographs of water bodies and visible algae blooms are being used as an early warning tool in some regions in the United States. Ohio Environmental Protection Agency (OEPA) routinely reviews satellite data to see if any drinking water sources seem to be having algae blooms. If the agency determines a bloom may be present, the water utility is contacted and asked to provide information, including how close the bloom is to the intake. Based on that information, OEPA decides if cyanobacteria counts and cyanotoxin screening should take place. The sensitivity of this method is unlikely to be high enough for monitoring drinking water supplies.

Operational monitoring (monitoring to assist in the operation of a supply) includes both regular inspections and testing. In small and remote systems, close attention should be paid to checking that the preventive measures used to protect water supplies are functioning.

The frequency of catchment assessments will depend on the characteristics of each site, the source of raw water, the time the water remains in storage, and the subsequent treatment that is provided. As well as regular inspections in the immediate vicinity of the intake area, every catchment where there is habitation or free public access should be comprehensively inspected at least once a year for potential sources of pollution.

A structured strategy for planktonic cyanobacteria monitoring programmes is recommended and might include:

Level 1 Visual inspection for transparency, discolouration:

- move to Level 2 if poor transparency and discolouration are observed.

Visual inspection for scums, detached, accumulated cyanobacterial and mats:

- move to Level 3, if visual inspection indicates that cyanobacteria are present.

Measurement of temperature and assessment of structure of the water column:

- move to Level 3, if the temperature is more than 18°C, or there is persistent stratification of the water body.

These inspections should be made weekly or fortnightly.

Level 2 Measurement of nutrient concentrations:

- dissolved nitrogen and total phosphorus should be measured. Phosphorus can be the nutrient that limits cyanobacterial growth, but in a substantial number of New Zealand lakes, growth is nitrogen-limited.

Measurement of hydrological characteristics, which should include:

- retention times of water in lakes
- the persistence of thermal stratification of lakes
- the accrual period in rivers. The accrual period is the amount of time available for growth of periphyton (attached algae) in rivers, ie, the amount of time between flood events.

Measurement of light penetration:

- penetration of light below the warm upper mixed layer in a stratified water body will favour cyanobacterial growth.

Inspection of the catchment to identify the source of the nutrients:

Information about factors in this level, which are likely to influence bloom formation, together with cell counts, will help to develop the ability to predict bloom formation. Monthly measurement is satisfactory, at least for the first two years; more frequently if there are rapid changes in the nutrient concentrations.

Level 3 Determination of biomass of cyanobacteria (at least fortnightly; weekly or more frequently if Alert Level 1 (see section 9.7.1 and Figure 9.5) is exceeded):

- identification of cyanobacterial taxa and population densities is a good basis for assessing risk
- assessing the potential for the presence of toxins may assist with decision making (eg, determining if potential toxin-producing taxa are present, assessing samples for cyanotoxin production genes or using passive sampling devices such as SPATT samplers; (see below)
- use the Alert Levels framework (see section 9.7.1 and Figure 9.5) to determine what action should be taken
- move to Level 4 if Alert Level 1 is exceeded.

Level 4 Determination of toxicity of the water or toxin concentrations (fortnightly is sufficient, unless there is reason to believe toxin concentrations are changing rapidly and are close to 50 percent of a PMAV):

- this level of monitoring allows more accurate assessment of the concentrations of toxins present in the water
- use the Alert Levels framework (see section 9.7.1 and Figure 9.5) to determine what action should be taken.

The collation of monitoring information gathered during one bloom event, (water appearance, water temperature, preceding weather conditions, hydrology (water levels and flows), nutrient concentrations, cell counts, cyanobacterial taxa, and toxin concentrations) will provide a valuable basis for predicting when future blooms may occur and the levels of risk associated with the bloom as it develops.

Cyanotoxin concentrations change with environmental and hydrological conditions, and toxin concentrations may be low at the start of bloom events. Current sampling practices (eg, grab samples) provide only a snapshot of cyanotoxins present at one point in time and may miss areas or times of highest risk, and can fail to give early warning. These are particular issues when sampling rivers where continuous flows transport toxins rapidly. A passive *in situ* methodology known as solid phase adsorption toxin tracking technology (SPATT) has been shown to be a simple and sensitive means of warning of toxic micro-algal bloom development and associated shellfish contamination in the marine environment. Wood et al (2010 and 2018) describe trials using SPATT samplers in rivers. SPATT sampling does not allow you to measure toxin concentrations within cyanobacterial cells; but the fraction of a toxin that has been released from cells into the water. Although it is not possible to relate the concentrations of toxins measured in the SPATT sampler to the concentrations in the river water, this technique provides a useful management tool for early warning of low concentrations of toxins in a water body allowing proactive management of a cyanobacteria problem.

Because toxin-production in cyanobacteria cannot be confirmed microscopically, making decisions about the potential risk in a water supply can be difficult. Analysis for the actual toxins is the ultimate means of assessing the risk, however, analysis for cyanotoxin production genes is an emerging tool that can assist with deciding when analytical testing is deployed and what toxins to test for. This technique uses polymerase chain reaction (PCR) to detect the DNA sequences that code for cyanotoxin production in cyanobacteria. Without the genes, cyanobacteria are unable to produce the toxins. When applied in a cyanobacteria monitoring programme, this technique provides an indication of the potential for cyanotoxin production in a water supply and can be used (alongside cyanobacteria cell counts) to trigger toxin testing of water. An additional advantage of the technique is that it provides guidance on which cyanotoxins to test for analytically. Because the technique is prone to false positives (as sometimes only a portion of the entire gene cluster required to produce the toxin is present in a cyanobacterial strain) and because gene copy numbers don't necessarily correlate with toxin concentration, follow-up toxin testing is required to determine the potential risk.

## 9.4 Compliance

Cyanotoxins are chemical determinands, and like other chemical determinands can be given Priority 2 classification. However, the way this assignment is made, and the consequent compliance requirements, is different from those of other chemical determinands.

The factors leading to these differences are:

- cyanobacteria may appear irregularly, or annually;
- cyanotoxins may be present at potentially health-significant concentrations for only short periods, so monitoring throughout the whole year is unnecessary;
- cyanobacterial numbers, and, hence, cyanotoxin concentrations, can increase rapidly, therefore higher monitoring frequencies than for other chemical

determinands are required to ensure that the water supplier is aware of toxin concentrations reaching health significant concentrations;

- unlike most chemical determinands, the health effects of cyanotoxins are acute at low concentrations and potentially fatal, although there may also be long-term effects.

Some compliance requirements for cyanotoxins result from a toxin being assigned as a Priority 2 determinand (DWSNZ section 7.3). Other compliance requirements have also to be met to ensure that the water supplier has systems in place to determine when cyanotoxins reach potentially health significant concentrations, and to manage the risk to their consumers. These requirements are contained in section 7.2 of the DWSNZ.

Section 7.2 (DWSNZ) lists four sets of requirements, two of which specify objectives that have to be met for compliance.

- 1 Collect information about the source that will assist in determining:
  - a) whether cyanobacteria are present in the source water
  - b) when cyanotoxin concentrations (in the source water) reach or exceed potentially health-significant concentrations (greater than 50 percent of PMAV).
- 2 Develop a protocol, approved by the drinking water assessor, that:
  - a) identifies which determinands or observations are to be monitored for assessing the development of cyanobacteria
  - b) specifies the actions that will be taken in the event of any cyanotoxins reaching a potentially health-significant concentration
  - c) initiates a cyanotoxin monitoring programme in the source water when the protocol indicates that the risk of cyanotoxins being present has reached a predetermined level based on evidence from 7.2(1)(b).

The ways in which these objectives are to be met are undefined. Risk management protocols that best suit supply circumstances can therefore be developed. This approach has been taken because of the variable relationship that exists between cyanotoxin concentrations in a water and surrogate parameters, such as cell count. These should be developed as a section of the Water Safety Plan (WSP) for the water supply. An example Alert levels framework for planktonic cyanobacteria based on overseas experience and available toxin quota data is presented in section 9.7.1. Local knowledge and site-specific challenges may mean that the framework and the cyanobacteria cell concentrations used to define the Alert levels might be adapted. Some references about the conditions that alter cyanobacteria growth and distribution include: Ahern et al 2008; Baldwin et al 2008; Bayer et al 2008; Burger et al 2008; Downs et al 2008; Kobayashi et al 2008; Redden and Rukminasari 2008; Ryan et al 2008; Shaw et al 2008.

Experience of managing cyanobacterial blooms in New Zealand waters is limited. The first set of requirements in section 7.2 (DWSNZ) therefore obliges the water supplier to gather information to provide a scientifically defensible basis for the protocol that has to be prepared in the second set of objectives. Measurements or observations that could be monitored to meet the first set of requirements include:



- source appearance,
- water temperature,
- pH,
- nitrogen and phosphorus concentrations,
- water level or flow (cyanobacteria bloom events normally have happened in low flow waters),
- taste and odour complaints,
- cell counts of cyanobacteria,
- determination of the presence of stratification in the water column (lakes and reservoirs),
- direct toxin measurement.

Experience may show that other parameters correlate well with the development of cyanobacteria in source waters. Sharing information between water suppliers in the same area or drawing from the same source, will assist in making best use of what has been learnt from past algal bloom events.

The protocol required for compliance requirement 7.2(2) is developed from the information collected as a result of meeting requirement 7.2(1). Completion of this protocol is not required for compliance, if its development is waiting for the data collection of requirement 7.2(1), and this collection is underway. As part of this protocol the water supplier must specify what actions will be taken to manage the health risk when a cyanotoxin reaches a potentially health-significant (greater than 50 percent of its PMAV) concentration. Section 9.7 of this chapter provides information that will assist in identifying the actions needed in these circumstances. These actions must be incorporated in the water safety plan (WSP – formerly known as a public health risk management plan, PHRMP).

The fourth compliance requirement of section 7.2 (DWSNZ) is:

- 4 notify the DWA when the protocol shows the development of cyanobacteria and cyanotoxins in the source water has reached a stage where source water cyanotoxins are approaching 50 percent of the PMAV.

It is important to keep the DWA regularly informed of the outcome of monitoring results so that, should the results indicate greater than 50 percent PMAV, the DWA can assign Priority 2b in a timely manner to protect public health. After Priority 2b has been assigned, it necessary for the supplier to monitor the source water, raw water and the treated water for cyanotoxins (section 7.3.2).

The completion of requirements 7.2(1) and (2) is needed to meet this requirement. Priority 2 determinands are usually identified through the Priority 2 Chemical Determinands Identification Programme. This is not possible for cyanotoxins because of the large and rapid variability in their concentration. The Priority 2 classification of cyanotoxins is therefore made by the DWA using monitoring information provided by the water supplier, requirement 7.2(4).

After a cyanotoxin has been classified as a Priority 2 determinand, the requirements of section 7.3 (DWSNZ) must be met. See section 9.5.2 of this chapter for information about recognised laboratories.

Samples for cyanotoxin testing must be taken twice-weekly from the water leaving the treatment plant. Either through the success of the actions set out in the WSP, or because of a subsidence in the size of the bloom causing the high cyanotoxin concentrations, the toxin concentration will eventually drop. Once the cyanotoxin concentration in three successive samples (taken at the required frequency of twice weekly) has been found to be less than 50 percent of its PMAV, and the concentration in each sample is less than the previous, the classification of the cyanotoxin is returned to Priority 3.

For other chemical determinands, monitoring of Priority 3 determinands is generally not required. This is because sufficient evidence should have been collected to establish that there is only a low likelihood of the determinand appearing in the water again at concentrations exceeding 50 percent of its PMAV. This assumption cannot be made for cyanotoxins because of the possibility of the redevelopment of a bloom. Therefore, although a cyanotoxin may be reclassified as Priority 3 and monitoring of the toxin itself may cease, the monitoring requirements of the protocol developed in section 7.2 of the DWSNZ must continue.

## 9.5 Sampling and testing

### 9.5.1 Sample testing

As with other testing required for demonstration of compliance with the DWSNZ, a Ministry of Health recognised laboratory must be used. Methods for analysis of the cyanotoxins are given in the datasheets (Volume 3, Part 2.4). Discussions on cyanotoxin analyses appear in publications by the Cawthron Institute (2005 and 2018). Because of the intermittent need for these tests, the instrumental analysis of cyanotoxins can be expensive.

Several New Zealand laboratories have IANZ accreditation for the identification and enumeration of cyanobacteria, and for cyanotoxin analysis. A list of the New Zealand laboratories recognised by the Ministry of Health to conduct analyses for cyanobacteria and related cyanotoxins may be found on the Ministry of Health website [www.health.govt.nz/water](http://www.health.govt.nz/water), 'Publications', located under 'Registers'. See the latest edition of the *Register of Recognised Laboratories: Drinking water supplies* (updated annually).

Whichever laboratory is used for testing, advice should be obtained from the laboratory about sampling containers for the particular determinand in question, before collecting the samples, because there is some evidence that common additives in plastics could contaminate water samples and co-elute with microcystins to give erroneously high readings (van Apeldoorn et al 2007).

Cyanotoxin field tests are being developed so water suppliers can monitor changes more rapidly than waiting for results from accredited laboratories. These include Abraxis Dipsticks, Creative Diagnostics Dipsticks, Jellet Rapid Test Kit, and Beacon MC Tube Kit. These are not currently accredited cyanotoxin test methods and can be expensive (perhaps up to \$50 per test), however, they provide a means of rapidly acquiring information on whether cyanotoxins are present in a waterbody to assist decision making. Health Canada (2011); Brylinsky (2012); Cawthron (2018).

## 9.5.2 Sample collection

Sampling to obtain information to help in the management of cyanobacteria may be undertaken via three routes:

- determination of nutrient concentrations (to assess the potential for cyanobacteria growth),
- assessment of the cyanobacterial population for both number and species (to assess for the organisms themselves),
- determination of cyanobacterial toxin concentrations (to assess for the determinand itself).

The following provides detailed guidance for sample collection and handling, and is based on the Queensland Harmful Algal Bloom Response Plan, 2002 (developed by the Department of Natural Resources and Mines, Environmental Protection Agency, Queensland Health, Department of Primary Industries, Local Governments and water storage operators, Australia). It is recommended that advice from the analytical laboratory carrying out the testing, or other local experts, be sought to determine whether the procedures given here need to be modified to suit the requirements of the laboratory or the conditions of the water source. Details for benthic monitoring and sampling have been adapted from the *New Zealand Guidelines for Cyanobacteria in Recreational Fresh Waters – Interim Guidelines* (2009). See also Biggs and Kilroy (2000).

### 9.5.2.1 Sampling for planktonic cyanobacteria

The design of monitoring programmes for cyanobacteria is challenging due to factors such as:

- their ability to grow in open waters,
- the ability of some species to regulate their buoyancy,
- the formation of surface scums that may be shifted and concentrated by wind,
- the interactions of buoyant cells with the surface drift currents created by wind,
- the ability of some species to produce toxins that may be contained in their cells or dissolved in water.

The heterogeneous (mixed) and dynamic nature of many cyanobacterial populations can make sampling site selection difficult. A flexible response to the current situation when choosing the sampling sites may, at times, be more appropriate than following a rigid programme. Alternatively, fixed sites may always be sampled within a broader monitoring programme, to provide linear time series, and supplemented with sampling

of sites currently harbouring cyanobacterial scums. Water suppliers are beginning to use drones to estimate cyanobacterial coverage. Satellite imagery is being used more frequently overseas to estimate the abundance of cyanobacteria in water bodies and to track the movement of cyanobacteria blooms in large lakes, however, its application is highly dependent on the size of the water body and the types of cyanobacteria blooms that occur in the water body.

The selection of sampling sites is a key factor in collecting representative samples. The following should be considered:

- the history, if available, of cyanobacterial population development and occurrence of toxins in the water body, or similar water bodies nearby, this information may indicate sites most likely to harbour scums/mats;
- specific incidents, such as animal deaths or human illness, may provide indications of 'high risk' sites;
- morphometric and hydrophysical characteristics of the water body (eg, exposure to wind or thermal stratification) may help identify sites which are prone to scum accumulation;
- prevailing weather conditions, particularly wind direction, which can lead to scum accumulation along certain shorelines;
- local logistical resources, accessibility and safety factors.

The nature of the information required should determine where samples are taken and how.

Two types of water sample can be taken: grab samples and composite samples. Grab samples are single samples used to provide information about a particular site at a particular time. Where there may be uneven distribution of a determinand, either in space (geographical location, water depth) or time, a composite sample may be necessary. This type of sample is designed to gather representative information about the determinand that cannot be provided by a single sample. A number of grab samples at different locations or times may be taken then mixed together, or the water may be sampled continuously while changing the location of sampler intake. The latter approach may be used in sampling at different depths, for example.

Concentrations of nutrients, cyanobacteria and cyanotoxins are unlikely to be the same throughout a water body because of stratification within it, and other factors such as wind and currents that may shift cyanobacterial masses. Unless the factors that may affect the concentration of a determinand within the water body are understood, interpretation of the data from a single grab sample is likely to be difficult.

Single grab samples are valuable when a water supplier wishes to know the cyanotoxin concentration entering the treatment plant at a particular time, or, the greatest cyanotoxin concentration that may challenge the treatment plant. When identifying the sampling location to gather worst-case information, consideration needs to be given to such factors, as the ability of some species to be blown by the wind on the surface of the water, or to accumulate at different depths in the water.

Samples should also be included from points where previous samples have revealed unsatisfactory water quality. When assessing the risk associated with cyanotoxins

entering the reticulated water, water suppliers should collect samples at locations and times likely to reveal the highest concentrations of cyanobacteria and their toxins.

Site inspection should be carried out at the time samples are taken. From this the following should be recorded:

- weather conditions, including the wind direction and velocity;
- whether the bottom of the lake/reservoir is visible at a depth of about 30 cm along the shore line;
- any distinct green, blue-green, or brown colouration of the water;
- a distinctive odour;
- signs of cyanobacteria as blue-green streaks on the surface or scum.

This information may assist in interpretation of sample analysis.

### Collecting water samples for planktonic phytoplankton identification and enumeration

Ideally sampling should be conducted from a boat. Depth integrated samples are recommended for open water sampling where a representative sample of the water column is desired. The samples should be collected using a flexible hose-pipe sampler. A rigid pipe can be fitted with a one-way valve, which tends to simplify the operation of withdrawing the pipe and sample from the water. The length of the sample pipe should reflect the appropriate depth to which the cells are likely to be mixed. This may vary from approximately 2–10 metres depending on the degree of stratification and exposure of the water body to the influence of wind. When the mixing status is unknown, a five-metre long pipe is recommended, however a two-metre long pipe may be more appropriate in shallower areas.

The inner diameter of the pipe should be at least 2.5 cm and flexible pipes are generally more practical than rigid pipes for pipe lengths greater than two metres. The recommended method for the use of the hose-pipe sampler is show below.

The following equipment is needed in order to take samples:

- integrated hose-pipe sampler: 5 m length of 2.5 cm diameter plastic piping with a weighted collar at one end (see Figure 9.2),
- a cord attached to the hose and boat,
- a rubber cork to fit one end of the hose,
- a bucket,
- a sample bottle and lid (minimum 200 mL capacity).

**Figure 9.2: Procedure for use of the integrated hose-pipe sampler for planktonic cyanobacteria and cyanotoxins**

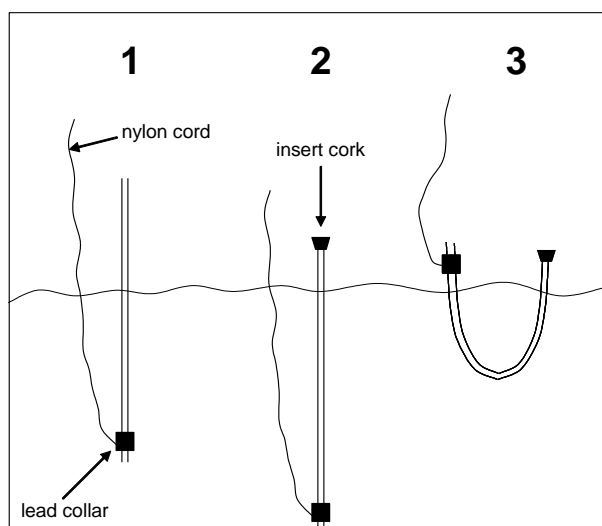

The procedure for collecting the sample is as follows:

- 1 Attach a cord to one end of the hose and the boat to prevent accidental loss of the hose.
- 2 Holding the hose at the top end, rapidly drop the weighted end of the hose-pipe into the water to a depth of about 5 m.
- 3 Return hose to the boat without inserting the rubber cork.
- 4 Rinse the hose.
- 5 Repeat the procedure, but this time insert the cork into top end of the hose (so that the end is held in the hand).
- 6 Pull the bottom end of the hose to surface using the cord, so that the tube is in a U-shape (see Figure 9.2).
- 7 Lower the weighted end of the hose into a bucket and remove the cork. Ensure that the entire contents of the hose are emptied into the bucket.
- 8 Mix the contents of the bucket and then transfer part of the contents into a sample bottle, leaving a 25 mm gap at the top of the bottle. Discard the rest of the contents of the bucket.

**Note:** Some species of phytoplankton can cause skin irritation. If sampling from an area that has a high concentration of phytoplankton, minimise contact with the water during sampling by wearing appropriate protective clothing, in particular gloves. Normal hygiene precautions such as washing off any splashes and washing hands before eating or drinking should be observed at all times. When not in use, the hosepipe sampler and bucket should be kept clean and stored in a dark shed or cupboard.

Where sampling from a boat is not practicable (eg, a river, bank, shoreline, bridge or valve tower) sampling should be assisted by the use of a pole-type sampler. The bottle is placed in a cradle at the end of an extendable pole to avoid contamination of shoreline-accumulated scums.

### 9.5.2.2 Sampling for benthic cyanobacteria

River intakes should also be inspected for benthic (attached) cyanobacterial mats. These appear as expansive, thick black or dark-brown slimy mats on the riverbed or growing on intake structures. The mats commonly detach from the substrate and float on the water surface, accumulating behind obstructions in the river channel or in lakes / reservoirs. For this reason, knowledge of cyanobacteria concentrations upstream from the intake site is also valuable. An underwater viewer is generally required to assess the extent of benthic cyanobacteria in rivers. These viewers are commercially available and allow a clear view of the stream bed with no interference from surface turbulence and reflection. They also enable definition of a more-or-less standard area of the stream bed at each survey point (ie, equivalent to a quadrat in terrestrial ecology).

Benthic cyanobacteria can also grow attached to the bottom substrate of lakes and reservoirs. This type of cyanobacteria poses a management challenge as it often grows out of sight (depending on water clarity) and can slowly accumulate even in low nutrient waters. Some signs of benthic cyanobacteria in water reservoirs can be the presence of cyanobacteria odour compounds (eg, geosmin or MIB) in the water, identified either through analytical testing or complaints from water consumers, despite an absence of cyanobacteria in planktonic cell count samples, or the observation of detached mats in the reservoir. If benthic cyanobacteria are suspected in a water reservoir, sediment samples should be collected using a Ponar grab sampler (or similar) and analysed for cyanobacteria or cyanotoxins. Multiple samples from around the water body may need to be collected to gather an idea of the extent of benthic cyanobacteria present. Alternatively, qualified divers could be used to survey the base of the reservoir for benthic cyanobacteria, however, this can be a costly exercise.

#### Collecting samples for benthic cyanobacteria identification and quantification

Under certain circumstances samples for benthic cyanobacteria may be required (eg, *Microcoleus autumnalis* and *Microseria wollei*; previously *Phormidium autumnale* and *Lyngbya wollei*). In most cases benthic samples are collected for qualitative analysis. Samples can be collected using a benthic sampler such as an Eckman grab or a rigid plastic corer (eg, PVC or polycarbonate pipe). Multiple samples from different locations or rocks should be taken and either analysed individually (if possible) or combined into a single container and analysed as a composite sample. If large quantities of sediment/sample are collected, this can be thoroughly mixed and a sub-sample for analysis can be stored in a smaller specimen jar.

#### Measuring the abundance of benthic cyanobacteria in rivers

For monitoring and sampling benthic cyanobacteria, upon arriving at a survey area, spend approximately five minutes looking along a 30–60 m section of river bed for the presence of cyanobacteria mats. Ensure that this section includes some runs and riffles. Mark out four transects in the selected area by placing marker rocks along the water's edge, approximately 10–15 m apart. Record details, including site, date, time, etc, and note the general presence/ absence of cyanobacterial mat and the presence of any detached mat along the shoreline. Assemble the underwater viewer and, starting at the downstream end, wade into the stream at right angles to the water's edge. Go out to a

depth of approximately 0.6 m (Figures 9.3 and 9.4). A standard maximum depth of 0.6 m should be used at all sites, where possible. In shallow rivers, the transects may span the entire width. Record the maximum distance and depth for transect 1. Hold the underwater viewer about 20 cm under the water more or less on the transect line. The area of view should be ahead of you, not one that has just been walked over. Holding the viewer steady and as vertical as possible, estimate to the nearest 5 percent the proportion of the area you see which is occupied by the cyanobacterial mat. Coverage should only be recorded if mats are greater than 1 mm thick. It is useful to record the presence of thin mats as well.

**Figure 9.3: Benthic cyanobacteria monitoring and sampling schematic of layout of transects and survey areas**

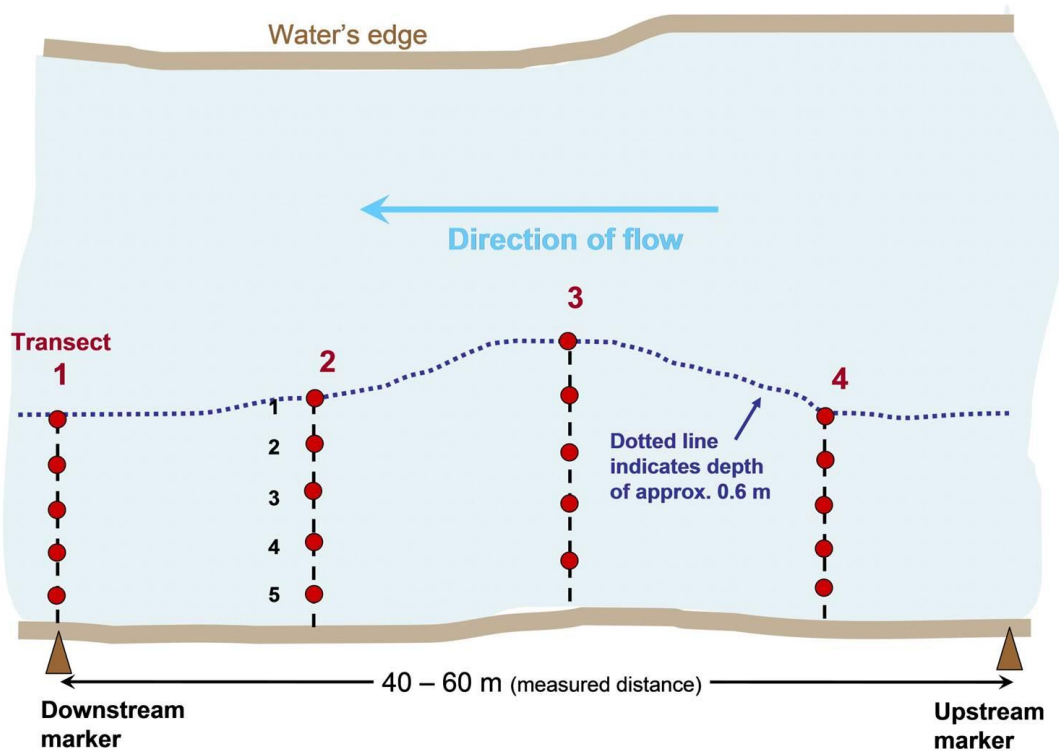
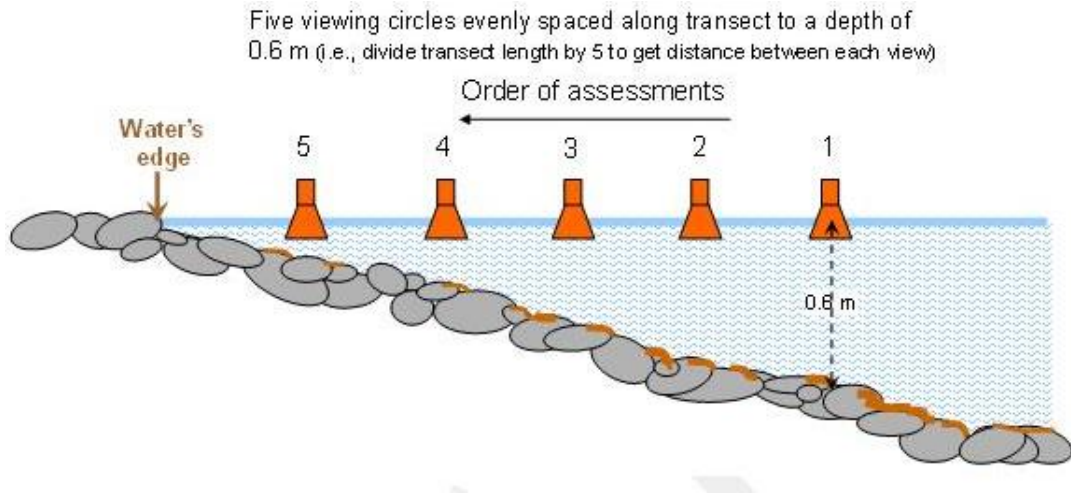

Figure 9.3 illustrates a benthic cyanobacteria monitoring and sampling schematic of layout of transects (numbered in red) and survey areas (red circles, numbered in black) at a site (not to scale). The numbering indicates the order in which assessments are made. The transects are spaced evenly along the survey reach. It may not always be possible to have five viewer results (ie, steep sided rivers), in these circumstances take as many views as practical per transect (Source: C Kilroy, NIWA).

Figure 9.4 illustrates a benthic cyanobacteria monitoring and sampling schematic of transect cross-section showing arrangement of sampling points (not to scale). Assessment 1 will cover a greater area than assessment 5 because of the greater water depth. However, this will be the case at all sites. Therefore, assessments should be comparable (from *New Zealand Guidelines for Cyanobacteria in Recreational Fresh Waters – Interim Guidelines*, source: C Kilroy, NIWA).



**Figure 9.4: Benthic cyanobacteria monitoring and sampling schematic of transect cross-section showing arrangement of sampling points**



### 9.5.2.3 Sampling for toxin analysis

- **Qualitative:** Qualitative toxin analysis is generally performed by bioassay, and is performed when either more sophisticated techniques are unavailable, or the identity of the toxin is initially unknown. Samples for qualitative analysis may be collected from concentrated scums or by trailing a phytoplankton net (10–50 µm mesh) from a boat or casting the net from the shoreline. The volume of sample required is dependent upon the concentration of the cells. Up to 2 litres may be required if cell concentrations are low. Advice should be sought from the analytical laboratory before collecting and submitting a sample for qualitative toxin analysis.
- **Quantitative:** Quantitative toxin analysis is performed using a variety of methods suited to the type of sample and the toxin present. Samples are collected in the same manner as those taken for phytoplankton identification and enumeration, however, storage conditions and the volume of sample is dependent on the type of analysis to be used (consult with the testing laboratory for specific information). In general, at least 500 mL of water should be collected.

### 9.5.2.4 Preservation, transport and storage of samples

- **Samples for identification and enumeration:** To ensure the sample remains in a condition suitable for identification and enumeration, Lugol's iodine preservative solution should be added to the sample as soon as possible after collection. See APHA (2005) for the recipe. Sufficient Lugol's iodine solution should be added to render the sample a colour resembling weak tea (ie, 0.5 mL Lugol's iodine per 100 mL of sample). It is sometimes useful to retain a portion of sample in a live (unpreserved) state, as some species of phytoplankton may be easier to identify in this way. The analytical laboratory can advise on whether unpreserved samples are required.

Preserved samples are reasonably stable as long as they are stored in the dark. If samples are unlikely to be examined for some time, they should be stored in amber glass bottles or PET plastic bottles with an airtight seal. Polyethylene bottles tend to absorb iodine very quickly into the plastic and should not be used for long-term

storage. Live samples will begin to degrade quickly especially if there are high concentrations of cells present. These samples should be refrigerated and examined as soon as possible after collection.

- **Samples for toxin analysis:** Careful handling of samples is extremely important to ensure an accurate determination of toxin concentration. Some toxins are readily degraded both photochemically (ie, by exposure to light) and microbially. Samples should be transported in dark cold conditions and kept refrigerated and in the dark prior to analysis.

#### 9.5.2.5 Training and quality

It is essential that staff involved in the collection of field samples be trained in all facets of collecting, transporting and delivering samples. Samplers should be aware of sample requirements including sample sites, types and numbers at each water body.

They should also be fully trained in the process of visual inspections and the need to collect samples of cyanobacterial scums if present. Samplers should undergo continual training to ensure new procedures are learned and existing skills are refreshed.

## 9.6 Transgressions

A transgression results from an exceedance of a cyanotoxin PMAV. This requires remedial actions to reduce the risk to consumers. Section 9.7 provides guidance material that can be used for planning the remedial actions to be taken following a transgression.

Remedial actions should not be left until a transgression has occurred; preventative measures should be put in place as a potential risk becomes apparent. When the routine monitoring undertaken as a requirement of section 7.2 of the DWSNZ shows the likelihood of algal bloom development or the growth of cyanobacteria to a level at which toxin concentrations may be a concern, remedial actions should be taken to reduce the likelihood of a transgression occurring.

Section 7.3.3 of the DWSNZ lists actions that must be taken in the event of a cyanotoxin transgressing its PMAV. These must be incorporated into the WSP when it is prepared. The WSP should also include any other actions the water supplier considers important for their particular supply. These may have become apparent during the collection of information undertaken to meet the requirements of section 7.2.

## 9.7 Risk reduction

### 9.7.1 Alert levels

An Alert Levels framework is a monitoring and management action sequence that water treatment plant operators and managers can use to provide a graduated response to the onset and progress of a cyanobacterial bloom. The decision tree provided in Figure 9.5 should be seen as a general framework to assist with developing a site-specific framework. It is based on local and overseas experience and data, but may require adaptation of specific alert levels and actions to suit local conditions. Individual water suppliers may wish to augment the minimum monitoring requirements set out in Figure 9.5, making use of their own data, knowledge and experience; this should be documented in the WSP. Where possible, water managers should gather information about cyanobacteria abundance (cell concentrations for planktonic cyanobacteria or percentage coverage for benthic cyanobacteria in rivers) and their relationship with cyanotoxin concentrations in their source waters. Site specific data may mean that the cell concentration thresholds used in a WSP may differ from the those in the alert levels framework in Figure 9.5. Monitoring of the type noted in Level 1 of section 9.3 could be used before the Vigilance Level in Figure 9.5 is reached to supplement the low frequency microscopic examination of the water.

Note that there are difficulties in identifying the risk arising from benthic cyanobacteria attached to riverbeds, the substrate of lakes and reservoirs or supply intakes by the microscopic examination of the raw water (ie, by determining cell concentrations in the water) required in Figure 9.5. Section 9.5.2 provides advice on sampling in these situations and an alert level framework for a site afflicted with benthic cyanobacteria may differ substantially from the example framework for planktonic cyanobacteria in Figure 9.5.

Cyanotoxins are currently measured in three suites: the microcystin / nodularin, the anatoxin / cylindrospermopsin, and the PSP (saxitoxin) suite, with each suite costing \$200–500. Because the cost of analysing cyanotoxins is high, water suppliers with source waters that have a history of cyanobacterial blooms will have a real incentive to manage their catchment and raw water quality. They will need to develop a contingency plan that can be implemented at short notice, see section 9.7.2.3.

**Figure 9.5: Alert levels framework for the management of planktonic cyanobacteria in water supplies**

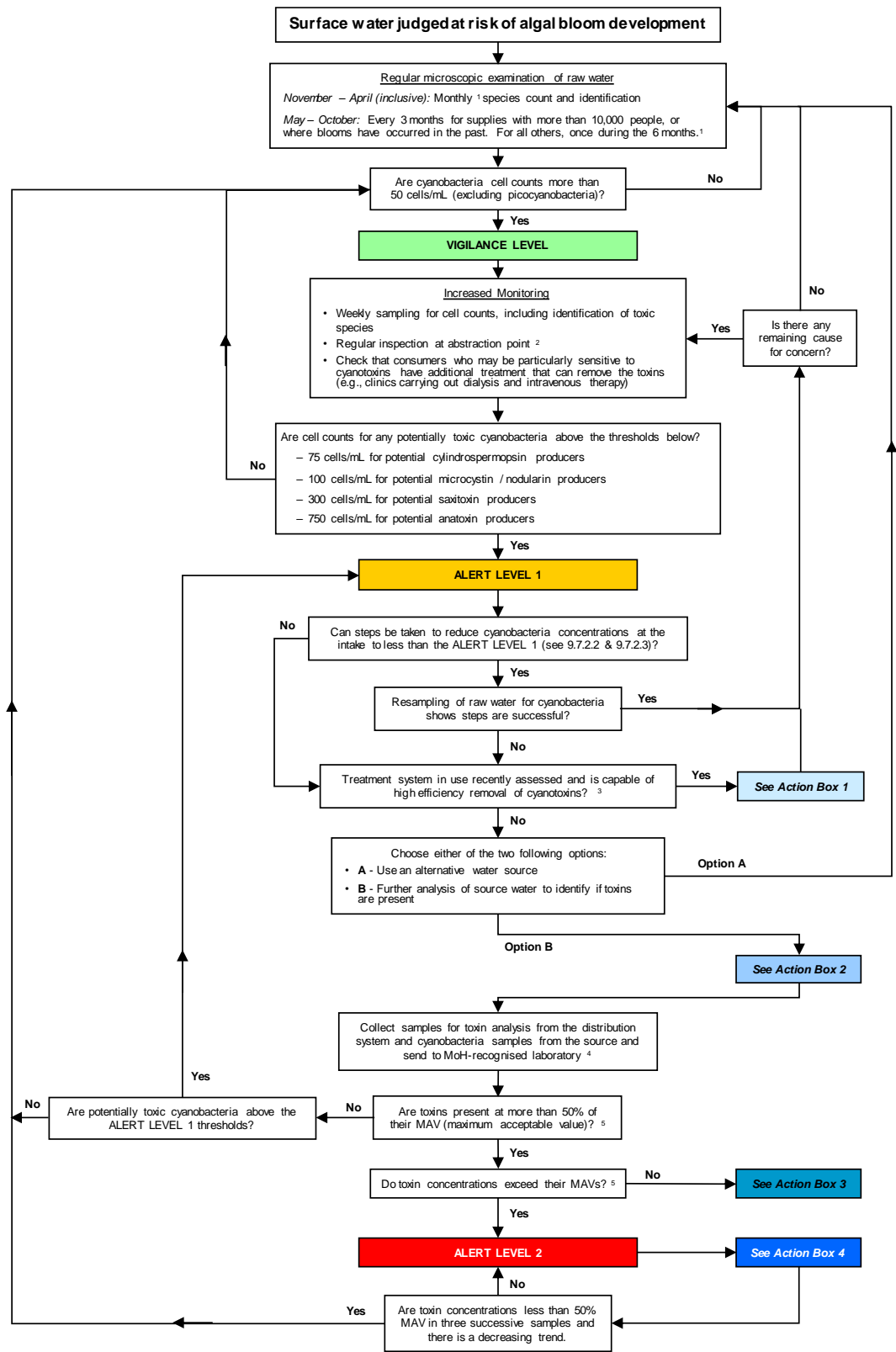

Notes:

- 1 Treatment plant staff must be able to recognise cyanobacterial blooms and know what action to take, if they develop between samplings.
- 2 Make sure intakes are not located where scum may be blown by the prevailing winds.
- 3 Treatment capable of removing more than 99 percent of cells without their lysis, or removing more than 90 percent of extracellular toxins (see Tables 9.4 and 9.5).

- 4 LC-FLD (liquid chromatography with fluorescence detection) will be needed to quantify saxitoxins. LC-MS (liquid chromatography – mass spectrometry) is suitable for all other toxins in the DWSNZ. ELISA (enzyme linked immunosorbent assay) is a research tool for saxitoxin analysis with potential for routine use. Where a calibration standard for a toxin is unavailable, bioassay should be undertaken to determine whether toxins present are a potential risk to health.
- 5 When multiple toxins are present in a water supply, the cumulative effects from toxins with similar modes of action should be accounted for (ie, cylindrospermopsins, microcystins and nodularins as hepatotoxins; anatoxins and saxitoxins as neurotoxins) using the ratio of each toxin concentration to the relevant MAV and summing the ratios (see s 8.2.1.1 of DWSNZ). Should this sum exceed 0.5 for 50% of the MAV, or 1 for 100% of the MAV, then proceed through the Alert Levels Framework.
- For example, if 1.5 µg/L of saxitoxins and 3.5 µg/L of anatoxin-a were detected in a drinking water, the ratio for these neurotoxins would be:
- saxitoxin,  $1.5 \mu\text{g/L} \div 3 \mu\text{g/L} = 0.5$   
 anatoxin-a,  $3.5 \mu\text{g/L} \div 6 \mu\text{g/L} = 0.58$ ,  
 giving a combined ratio of,  $0.5 + 0.58 = 1.08$ .
- This value exceeds 1 (the MAV) and consequently the Alert Level 2 threshold is breached.

Source: Modified from Chorus and Bartram 1999. Cell counts based on Australian Drinking-water Guideline 6 (2004). Other data sources: Jones et al 1993, NHMRC/ARMCANZ 1996.

## Action Box notes

### Action Box 1

- Continue regular monitoring of raw water (and treated water if necessary) to ensure adequate system performance, particularly if the cyanobacteria cell concentrations remain above the Alert Level 1 thresholds.
- Consider analysis of the treated water to confirm the absence of toxins.

### Action Box 2

- Consult with health authorities and other appropriate agencies.
- Investigate options for reducing the nutrient load.
- Ensure that the local authority places signs at the water source, warning people not to swim, fish or practise any other sport within the contaminated areas.
- Prepare to:
  - implement water supply contingency plan
  - use an alternative source of water, or
  - use water treatment processes capable of removing cells or toxins (see section 9.7.2.3 and Tables 9.4 and 9.5), or
  - provide drinking-water by tanker or bottles.

### Action Box 3

- Continue monitoring as required by section 7.3.2 (DWSNZ). Ideally, samples of raw water should be composite collected over 24 hours.
- If possible, use an intake that has not been affected.

- Assess level of health risk using Figure 9.1.

#### Action Box 4

- Continue monitoring as required by section 7.3.2 (DWSNZ), but preferably increase the monitoring frequency to daily, if toxin concentrations are near, or exceed their MAV.
- Close the water body temporarily.
- Assess level of health risk using Figure 9.1.
- If not already done, have water analyses carried out to determine which toxin is present, and its concentration.
- Activate contingency plan (which should include):
  - use of alternative water source, OR
  - provision of drinking water by tanker or in bottles, OR
  - use of advanced treatment processes (powdered activated carbon and/or DAF (dissolved air flotation) and/or ozonation)
  - provision of safe water from an alternative source (eg, tanker) to consumers particularly sensitive to toxins (eg, clinics carrying out dialysis or intravenous therapy)
  - increase sampling for cell counts (or biovolume) to assess bloom growth/decay, and help in management of raw water abstraction
  - use of aeration of the reservoir to reduce cell growth.
- Contact the DHB so they can coordinate with their dialysis patients directly.
- Routine supervision of dialysis clinic water treatment system.
- Consider whether there is a need to replace the water treatment plant sedimentation step with a DAF system.
- Do not use water source for drinking again until four weeks after testing shows that the toxin concentrations are consistently less than 50 percent of their MAV, cell counts have returned to less than the Vigilance Level Threshold (50 cells/mL, excluding picocyanobacteria), or cell counts are less than the Alert Level 1 Threshold when potential toxin-producing cyanobacteria are present:
  - 75 cells/mL for potential cylindrospermopsin-producing cyanobacteria
  - 100 cells/mL for potential microcystin-producing cyanobacteria
  - 300 cells/mL for potential saxitoxin-producing cyanobacteria
  - 800 cells/mL for potential anatoxin-producing cyanobacteria

## 9.7.2 Preventive and remedial measures

Providing safe drinking-water from cyanobacteria-infested surface waters requires consideration of the system as a whole, and the use of different combinations of

resource management and treatment tailored to the specific locality. There also needs to be local assessment of performance and local optimisation of resource management and treatment strategies.

A drinking-water safe from cyanotoxins will either draw from a resource that is unlikely to harbour cyanotoxins (eg, groundwater or surface water that does not support cyanobacterial growth), or have treatment in place that is likely to remove cyanobacterial cells (without causing their rupture) as well as removing cyanotoxins. When cyanobacterial blooms occur in New Zealand, alternative water sources are often unavailable, and water treatment plants may not have the capacity to remove all cyanobacterial cells or related toxins that are the prime health hazard. However, in many circumstances a potential cyanotoxin hazard can be managed effectively without the necessity of advanced treatment processes, through good water resource management.

There are three levels of management, consisting of preventive and remedial measures that can be used to control cyanobacteria and their toxins. In decreasing order of preference, these are:

- measures to reduce nutrient inputs into the water,
- management of the source water or reservoir,
- treatment to remove cyanobacteria or their toxins.

An important aspect of managing cyanotoxins, as with any risk management planning, is to ensure an emergency incident plan has been developed in advance in the WSP to deal with situations in which preventive measures have failed and rapid cyanobacterial growth has led to acutely dangerous toxin concentrations. These plans need to take into consideration, as far as possible, the capacity of water supply and laboratory personnel to react to emergency situations.

### 9.7.2.1 Measures to reduce nutrient inputs

Cyanobacterial bloom formation can be avoided by reducing the (controllable) factors allowing the cyanobacteria to grow; ie, nutrients and light.

A water supply's WSP should identify activities and situations within the catchment that may adversely affect water quality. Activities leading to the direct input of human or animal waste into water or indirect input through processes such as run-off from pastures, or fertiliser use, should be identified as a concern. To reduce the effects of these activities on the nutrient concentrations in the water, steps need to be taken to limit animal access to water sources, and to encourage agricultural practices that minimise the loss of nutrients in manure and fertiliser into water sources through run-off. Treatment of sewage to reduce its nutrient content, before disposal into water or on to land, may also be needed.

Land use and land practices are often outside the direct control of water suppliers. In these circumstances, assistance from the regional council should be sought to work with the affected community to determine what actions to reduce nutrient input are practicable.

There may be a substantial delay (many years) between the introduction of steps to reduce nutrient input and nutrient concentrations dropping below levels expected to sustain an algal bloom. This is because feedback mechanisms within the ecosystem, such as the release of nutrients that have been stored in sediments, will continue to release nutrients into the water during periods of thermal stratification. Artificial mixing of a reservoir, to limit thermal stratification and the release of sediment-bound nutrients, is another means for reducing bio-available nutrients in a water reservoir, however, this strategy generally has high costs associated with it. Sediment capping is a water quality restoration technique, where nutrient-rich sediment is covered by a capping agent that blocks the release of nutrients during periods of stratification. However, before sediment capping is considered, the introduction of nutrient-rich sediment into the reservoir should be addressed otherwise new sediment will be deposited on top of the capping agent and internal nutrient cycling processes will restart.

Nutrient concentrations should be monitored following the introduction of nutrient reduction measures, so that trends in these concentrations can be identified.

### 9.7.2.2 Management of the source water or reservoir for planktonic cyanobacteria

Management of the source water or reservoir to reduce the concentrations of cyanobacteria and their toxins being taken into the water supply include:

- engineering techniques to alter the hydrophysical conditions to reduce cyanobacterial growth,
- positioning of abstraction points,
- selection of intake depth,
- abstraction through an infiltration gallery,
- barriers to restrict scum movement,
- use of algicides, which should be used with extreme caution because of their ability to cause cell lysis and the release of toxins into the water.

Natural microbial populations in water bodies can degrade cyanotoxins.

Measures addressing light availability directly (eg, artificial mixing or shading) or controlling nutrients by manipulating the types and numbers of organisms (eg, aquatic plants or non-toxic microalgae that compete for nutrients with the cyanobacteria) is an area that has been used successfully; primarily in less eutrophic situations. For highly eutrophic waters under restoration by a reduction of nutrient loading, such measures may accelerate and enhance success.

A commercial product, Phoslock™, has been developed in Australia that is designed to remove phosphorus from water. Phoslock™ is a reaction product of bentonite clay and lanthanum chloride in which the proportion of exchangeable cations (mainly sodium) is replaced by lanthanum cations through electrostatic binding. Phoslock™ is designed to adsorb oxyanions, predominantly phosphate, from a variety of natural aquatic environments notably in order to reduce the incidence of algal blooms. The



recommended dosage is 100:1 Phoslock™ to filterable reactive phosphorus (FRP). NICNAS (2014) has assessed the use of Phoslock™.

Proactive reduction in nutrient concentrations using riparian strips and control of land use, etc. is a preferred action compared to the persistent control of cyanobacteria using algicides such as copper sulphate. Algicides have difficulty in removing a bloom; they are more effective at preventing a bloom if dosed early enough. Risk management issues relating to algicides are discussed in the MoH Water Safety Plan Guide Ref. P4.1: Pretreatment Processes – Algicide Application. See also CRCWQT (2002). The use of copper sulphate to control cyanobacterial growth can release toxins through cell lysis, and either destroy the natural micro-organisms that degrade toxins, or inhibit the action of the enzymes that carry out the degradation (Heresztyn and Nicholson 1997). Copper sulphate may prevent formation of phytoplankton blooms if dosed early enough, preferably in the morning when cyanobacteria are likely to be close to the surface and the water is generally calm, but algicides are unlikely to eliminate a bloom, once it is underway.

A study by Water Quality Research Australia (WQRA 2012) assessed the performance of copper sulphate, chelated copper sulphate, stabilised hydrogen peroxide,<sup>1</sup> sediment capping, surface mixing, and ultrasound treatment for control of algae and cyanobacteria. Performance of the algicides depended on water quality and the type of organism; all needed a higher dose than claimed by the supplier.

Control of cyanobacteria blooms using ultrasonics have not been shown to be particularly effective to-date.

### 9.7.2.3 Treatment options to remove cyanobacteria and cyanotoxins

The final step in controlling cyanobacteria and their toxins is the water treatment process. The water treatment train needs to be able to remove suspended material (bacterial cells) as well as water soluble toxins (eg, microcystins, nodularins, saxitoxins, cylindrospermopsins and anatoxins), which are the primary health hazard. The effectiveness of a water treatment system in doing this is determined by many factors. The brief analysis below, based on a comparative assessment of experiments in countries affected by cyanobacterial contamination, identifies the main factors and also the capacity of established and novel treatment processes for the removal of cells and dissolved toxins. As a general observation, conventional surface water treatment plants using coagulation, clarification and filtration are effective in removing cyanobacterial cells, but they are only partially successful in removing cyanobacterial toxins.

Much of the work on cyanotoxin removal has focused on single treatment steps, but a multi-barrier approach is more effective.

Until a bloom collapses or is otherwise affected by some treatment practice, the majority of toxins will be retained within the cells, making removal of intact cells a high treatment priority. Cylindrospermopsin and deoxycylindrospermopsin may be exceptions, as these toxins can be released by actively growing cells into the

<sup>1</sup> This can be sodium carbonate peroxyhydrate which releases sodium carbonate and hydrogen peroxide.

surrounding water. Under bloom conditions, a substantial proportion of toxin may be released to the water column, making removal of soluble toxin an unavoidable concern.

Table 9.4 summarises the toxin-removal performance of treatment processes capable of removing cell-bound microcystins by removing whole cells. The effectiveness of processes that can remove extra-cellular toxins (ie, oxidation/disinfection processes and activated carbon processes) are presented separately in Table 9.5. Table 9.5 sets out removal data for a range of toxin groups.

A number of factors concerning good practice and the effective design and operation of treatment plants should be considered in conjunction with the information in Tables 9.4 and 9.5. These include:

### General

- Chemical preparation and dosing facilities must be of adequate size, have appropriate retention times, and chemical doses and treatment conditions (eg, pH level) should be optimised.
- Frequent monitoring of treatment performance is crucial to ensure safety, particularly with respect to cyanotoxin removal. The performance of different treatment steps is variable, for reasons that are not understood, and there is no suitable surrogate that can be used to assess cyanotoxin removal. Variable and often high loads of dissolved organic carbon (DOC) during cyanobacterial blooms may rapidly compromise treatment procedures that were initially successful. This is because non-toxic natural organic matter, which is present at much higher concentrations than the cyanotoxins, may saturate the capacity of the treatment process.
- Best results are achieved by combinations of treatment steps, and by the separate evaluation of cell removal and the removal of dissolved toxin (eg, combinations of pre-oxidation to enhance cell removal with effective post-oxidation to ensure destruction of liberated toxin, or combinations of cell removal and slow sand filtration).
- The complexity of managing cyanobacterial contamination necessitates consultation with the relevant health authority.

### Raw water treatment and pre-oxidation

- Raw water sources and abstraction should be managed to minimise the cyanobacterial concentrations in the raw water delivered for treatment, but such steps as adjusting the abstraction depth.
- An earlier process used in New Zealand was microstraining, see Chapter 12. A microstrainer would be particularly effective at removing filamentous algae and cyanobacteria.
- Pre-oxidation should be avoided because it often results in cell lysis and resulting release of cyanotoxins into the water. Physical removal of cells should be undertaken before high concentrations of pre-oxidant are added to the water. Separation of steps into a low pre-oxidation dose to enhance flocculation, and a higher dose after cell removal to oxidise dissolved toxins is a safer approach. Pre-

oxidation should not be used, if it cannot be shown that the process results in an overall improvement in the removal of cyanotoxins.

- Pre-ozonation is preferable to pre-chlorination, especially in conjunction with primary disinfection by ozone further down the treatment line, eg, between clarification and filtration (usually dosed at a minimum of 1 mg/L).
- Algicides, such as copper sulphate, as well as pre-oxidants, can cause cell lysis and the release of cyanotoxins.

### Coagulation/flocculation/clarification

- Conventional treatment plants without ozone or granular activated carbon (GAC) might satisfactorily remove cyanobacterial cells and dissolved toxins if coagulation, clarification, filtration and superchlorination – dechlorination (with a C.t value of more than 15 mg/min/L) or ozonation are carried out effectively.
- At optimum turbidity and UV absorbance removal rates, coagulants such as aluminium sulphate, PAC and ferric chloride are able to remove most cyanobacterial cells without physical damage and the release of toxins, eg, *Microcystis aeruginosa* and *Anabaena circinalis* cells (Drikas et al 2001). Lysis will be more predominant if coagulation occurs at pH <6.
- However, under normal bloom conditions it is highly likely that the cells are in various stages of their growth cycle, with some already dying and releasing toxins. A further treatment step may therefore be required to remove extracellular toxins.
- Under normal operating conditions, very little additional toxin is released from settled cells if sludge is rapidly removed from sedimentation basins. However, cells that are held up in the sludge blanket can remain viable and multiply for at least 2–3 weeks, so increasing the sludge blanket discharge volumes or frequency will probably be required.
- Recycling to the head of the plant of supernatant from sludge thickening or drying should not be done until the bloom is over or all toxins in the sludge have degraded.
- Dissolved air flotation (DAF), in which the clarification (sedimentation) process is replaced by the release of compressed air into the water to float flocs to the surface, has often been found more effective than clarification in removing cells from cyanobacteria-rich waters.

Some other observations reported by Newcombe et al (2015) are:

- Do not use prechlorination.
- While turbidity cannot be used as an indicator of the presence of cyanobacteria or cell concentration, use the decrease in settled water turbidity with coagulant dose as a surrogate for, or indicator of, cell removal if the initial turbidity is greater than 10 NTU.
- If the presence of cyanobacteria results in increased coagulant demand to achieve improved settled water turbidity, the application of a particulate settling aid, or even powdered activated carbon, may lead to improvements.
- In most conditions, *Cylindrospermopsis raciborskii* was the least readily removed cyanobacterium by coagulation, maybe <90 percent.

Although removal of cyanobacteria through conventional coagulation can be very effective, 100 percent cell removal is unlikely in normal full scale operations; in general 90–95 percent removal was the optimum. In the event of high cell numbers entering the plant, monitor for cell carryover and accumulation in clarifiers. This can lead to serious water quality problems if not rectified.

## Chlorination

USEPA (2015 and 2016) states that the effectiveness of chlorine in microcystin and cylindrospermopsin oxidation is highly dependent on pH, temperature, water quality and the initial toxin concentration. Oxidation of extracellular cyanotoxins is most effective when the pH is below 8. This is especially the case for microcystins. Cylindrospermopsin can be effectively oxidised by chlorine when the pH ranges from 6 to 9. Chloramines and chlorine dioxide are not effective for microcystins or cylindrospermopsin oxidation at typical contact times used in drinking water application. USEPA (2015) includes a table showing chlorine C.t values (explained in Chapter 15) for reducing microcystin-LR to 1 µg/L in a batch or plug flow reactor. This table has been copied to Appendix 1 of this chapter. See section 3.3 of the USEPA (2015) report for how to calculate C.t values to achieve a lower concentration of microcystin-LR or use the Cyanotoxin Tool for Oxidation Kinetics (CyanoTOX, a spreadsheet tool for estimating the removal of extracellular cyanotoxins under various conditions; Stanford et al, 2016).

Monochloramine and chlorine dioxide are not effective.

## Ozonation (WQRA 2010)

Microcystins and cylindrospermopsin: at pH > 7 maintain an ozone residual >0.3 mg/L for at least 5 minutes contact. C.t values in the order of 1.0 mg min L<sup>-1</sup> have been shown to be effective.

Saxitoxins: ozonation is not recommended as a major treatment barrier, at this stage, more research is required.

## Supernatant return

WRF (2016a) suggests:

Sludge treatment facilities offer a suitable environment for the persistence and proliferation of cyanobacteria, and confinement in the sludge may not result in rapid cell death as previously believed. In supernatant sampled from a full-scale treatment plant, cultured and environmental cyanobacteria remained viable, and in some cases multiplied, over a period of up to 35 days. This suggests that the supernatant itself may offer a suitable environment for cyanobacteria to thrive. This is particularly a risk in sludge lagoons, which are shallow and often have detention times of several weeks, allowing accumulation and proliferation of cyanobacteria not captured in the sludge.

In batch reactors in the laboratory, it was shown that cyanobacteria can survive and produce metabolites for at least 10 days in alum sludge, suggesting that in the dynamic environment of a full-scale sludge treatment facility cell survival may be even more prolonged. Mass balance evaluations suggest that metabolite concentrations may increase to up to five times the initial concentrations within the sludge blanket. This indicates a much greater risk associated with recycling

sludge supernatant than can be estimated from the raw water quality. This potential increased risk should be taken into consideration when operational decisions regarding recycling are required. In light of these results, a qualitative assessment based on the inlet metabolite mass balance may prove to be a significant underestimation of the actual risk to drinking water quality. The very wide range of biological, chemical, and physical parameters that may influence the concentration of metabolites in sludge supernatant severely restricts the ability of water quality managers to estimate risks associated with supernatant recycling.

Some general conclusions were drawn based on the research. Due to its rapid release and degradation in most environments, geosmin exhibits the lowest risk to water quality. In contrast, MIB, microcystins, saxitoxins and cylindrospermopsins pose a significant risk to water quality and safety if the practice of supernatant recycling is continued. The findings of this research and previous literature show that, in a static (batch) system:

- cyanobacteria, once captured in the sludge, will generally begin to lyse between 0–2 days;
- some cells will remain viable in the sludge, and the maximum release (indicative of total cell death and lysis) may take up to several weeks;
- the metabolites released may represent up to five times the initial mass in the closed system;
- the time taken for the biodegradation of the metabolites to half the observed maximum concentration may be a week or longer, depending on the metabolite and the environmental conditions.

It is probable that during an ongoing cyanobacteria challenge, in the dynamic system of a sludge lagoon or other treatment facility, these timeframes will be significantly longer as cells and metabolites are replenished in the system.

The supernatant return should remain offline for 3–4 weeks after the challenge has abated, to allow the cyanobacteria numbers to decrease and the metabolites to degrade. Before bringing the supernatant return back on line the cell numbers and metabolite concentrations should be determined to be at an appropriate concentration for the treatment barriers. This is particularly important in the presence of saxitoxins, which are recalcitrant to biological degradation.

### Sand filtration

- Slow sand filter plants remove phytoplankton cells effectively, although pre-treatment steps are generally applied to maximise filter runs and efficiency. Because of the biological activity in slow sand filters and long contact times, some removal of dissolved toxin should be expected, but this capability is unclear. Slow sand filter plants with pre-ozonation and/or sand-GAC sandwiching would be expected to be effective for dissolved toxin removal (but this has not been confirmed). Slow sand filtration is not a common treatment process in New Zealand.

## Membrane filtration

- Cells can be removed by membrane filtration systems. However, care is needed when selecting microfiltration membranes because the characteristics of the membrane will affect the extent to which cells trapped in the membrane cannot be removed during backwash. Death and lysis of these cells will then result in toxin release into the water.
- Care is needed in the use of direct filtration, as long filter runs will trap more cells in the filter bed than short runs, leading to release of greater amounts of cyanotoxins following cell death and lysis.
- Recent studies by Water Research Australia (WRA) indicate that a nanofiltration (NF) membrane as the final stage of an integrated membrane system (IMS) may be the best method for maximising removal of extracellular cyanobacterial metabolites. Selection of the correct NF membrane was essential. The most efficient removal of cyanobacterial metabolites was achieved with using a polyamide NF membrane with a molecular weight cut-off (MWCO) of about 100 Da. This membrane should also be hydrophilic for the best retention of flux. A ultrafiltration membrane incorporating coagulation and powdered activated carbon addition is also a practical treatment. Aluminium chlorohydrate (ACH) is the best readily available coagulant for removal of intracellular cyanobacterial metabolites. ACH may also be a better coagulant for UFIMS in remote locations as lower doses are required for flux retention (WRA 2012).

AWWA/WRF (2015) states that RO effectively removes extracellular cyanotoxins. Typically, NF has a molecular weight cut off of 200 to 2,000 Da, which is larger than some cyanotoxins. Individual membranes must be piloted to verify toxin removal.

## Activated carbon

- Granular activated carbon plants with a high empty bed contact time (EBCT) and ozone-GAC facilities can remove toxins effectively, especially if the GAC supports substantial biological activity.
- The effectiveness of treatment plants without ozone, but with GAC, will depend on the GAC EBCT value, on the degree of biological activity on the GAC, on the extent of exhaustion of the GAC and of the magnitude and duration of toxin occurrence.

Water treatment plants with rare or occasional cyanobacterial blooms are not likely to have GAC filters. Without these, powdered activated carbon (PAC) will be needed. Water supplies likely to experience cyanobacterial problems should make provisions for dealing with them. It will be necessary to find out how to purchase activated carbon for prompt delivery, and there needs to be a process in place for dosing it; these should be noted in the section of the WSP dealing with cyanobacteria and cyanotoxins.

Generally, a conventional treatment train, including the combinations of coagulation, flocculation, settling or flotation, and filtration, is preferred to treat cyanobacteria-rich waters. Picoplanktonic cyanobacteria (cyanobacteria less than 2 µm in diameter), however, are not easily removed by most filtration systems.

Boiling water typically does not destroy cyanotoxins, and cell destruction can lead to the toxins becoming more bioavailable. If boiling of water is used as a means of

destroying other micro-organisms (ie, pathogens), further water treatment must be undertaken to deal with the cyanotoxins.

In addition to the possible natural degradation of toxins by other microbes in the water, sunlight has been found to reduce the toxicity of anatoxin-a (Stevens and Krieger 1991).

WQRA (2010) includes a full discussion on the effectiveness of different grades of activated carbon, and the selection of dose rates.

### Alternative source of drinking water

If contingency treatment options are unrealistic, water suppliers may need to consider treating an alternative raw water, or delivering safe drinking-water while the normal supply remains suspect.

**Table 9.4: Summary of performance of water treatment processes capable of removing cell-bound microcystins by removing whole cells**

| Treatment process                                     | Expected removal <sup>1</sup>           |   | Comments   |
|---|---|---|--|
|   | Cell bound                              | Extra-cellular                                    |  |
| Copper sulphate dosing of impounded water             | Very high                               | Causes lysis and release of dissolved metabolites | Usual effective dose 1–2 mg/L, but has been found toxic to some cyanobacterial species at concentrations less than 1 mg/L.<br><br>Limited significance to human health at the doses commonly used. Accumulation in sediment can cause environmental problems, and fish find it toxic at concentrations well below the doses effective for cyanobacterial control. Toxins in the water column must be removed by some other treatment method. |
| Pre-ozonation   | Very effective in enhancing coagulation | Potential increase                                | Useful in low doses to assist coagulation of cells; risk of toxin release requires careful monitoring and possibly subsequent treatment steps.   |
| Pre-chlorination                                      | Effective in enhancing coagulation      | Causes lysis and release of dissolved metabolites | Useful to assist coagulation of cells but applicable for toxic cyanobacteria only if subsequent treatment steps will remove dissolved toxins and other released metabolites.   |
| Combined coagulation/ sedimentation/ filtration       | High                                    | Low   | Removal only achievable for toxins in cells, provided cells are not damaged. Cells of some species may be more susceptible to damage than others.  |
| Coagulation/ dissolved air flotation                  | High                                    | Not assessed, probably low                        | Removal only achievable for toxins in cells, provided cells are not damaged. Cells of some species may be more susceptible to damage than others.  |
| Precipitation (for hardness reduction)/ sedimentation | High                                    | Low   | Removal only achievable for toxins in cells, provided cells are not damaged. Cells of some species may be more susceptible to damage than others.  |
| Direct filtration                                     | Moderate                                | Low   | Removal only achievable for toxins in cells, provided cells are not damaged.   |
| Slow sand filtration                                  | Very high                               | Probably significant                              | Removal effective for toxins in cells; efficiency for dissolved microcystin is likely to depend on biofilm formation and thus on filter run length.  |

|                    |                        |           |   |
|--------------------|------------------------|-----------|---|
| Membrane processes | Likely to be very high | Uncertain | Depends on membrane type, further research required to characterise performance. Some ultra-filtration membranes are able to remove dissolved microcystins, and nanofiltration and RO membranes are also expected to be able to achieve this. |
|--------------------|------------------------|-----------|---|

Based on data from Chorus and Bartram 1999 and Drikas et al 2001.

- 1 Likely efficiency of removal when continuously applied at optimal doses and pH and under proper operating conditions.

The processes in Table 9.5 are ineffective at removing whole cells, although some oxidants are able to lyse cells and destroy the intracellular toxins they contain.



**Table 9.5: Efficiency of dissolved toxin removal by oxidants/disinfectants and activated carbons**

| Oxidant/disinfectant or activated carbon | Dissolved toxin removal |                            |                                      |  |  | Comments   |
|--|-------------------------|----------------------------|--------------------------------------|--|--|--|
|  | Microcystins            | Nodularin                  | Anatoxin-a                           | Saxitoxin  | Cylindrospermopsin                                     |  |
| Chloramine                               | Ineffective             | Ineffective                | Ineffective                          | –  | Ineffective  | Free chlorine application will yield ineffective chloramines in waters enriched with nitrogenous compounds.  |
| Chlorine                                 | High (pH < 8)           | Very high (pH < 8)         | Low (pH 6-7)                         | High (pH ≈ 9)  | Very high (pH 6 –9)                                    | Toxin destruction is pH-dependent, and pH control is necessary. Conditions for removals noted are for free chlorine >0.5 mg/L and contact time > 30 minutes. Effectiveness reduced with increased dissolved organic carbon (DOC). The cells of some cyanobacteria can be lysed and the toxins they contain destroyed by chlorine.                          |
| Chlorine dioxide                         | Ineffective             | –                          | Ineffective                          | –  | Ineffective  | Ineffective for the doses used in drinking-water treatment. Limited data.  |
| Hydrogen peroxide                        | Ineffective             | –                          | –                                    | –  | –  | Ineffective on its own. Limited data.  |
| Ozone                                    | High                    | High                       | High                                 | Low – moderate<br>Variable effectiveness – dependent on toxin variant  | High   | Level of removal influenced by water chemistry (ozone demand). Cell lysis followed by intracellular toxin destruction has been observed for microcystins. In general, the ozone dose should be sufficient to provide an ozone residual after five minutes contact time. Effectiveness reduced at lower temperatures.                                       |
| Potassium permanganate                   | High                    | –                          | High                                 | Ineffective  | Low – moderate, more data required                     | Contact time 30 minutes. Effective on soluble toxin but only in absence of whole cells.  |
| UV irradiation                           | Ineffective             | –                          | Ineffective                          | –  | Ineffective  | Toxins can be destroyed by UV light, but not at the doses used in water treatment. Titanium dioxide has been found to catalyse the destruction of some toxins. Advanced oxidation, combining hydrogen peroxide and UV treatment, appears effective for the removal of anatoxin-a and cylindrospermopsin, and microcystins when using high UV doses.        |
| Powdered activated carbon (PAC)          | High                    | Some removal, limited data | Some removal, limited data           | Poor to very high<br>Depends on carbon and toxin variant   | Moderate<br>More data required for reliable evaluation | Effectiveness depends on the type of activated carbon, and water quality conditions. Carbons with a large number of large pores provide best removal. Wood-based carbons usually provide best removal. Large differences in levels of removal are seen between different microcystin variants. Doses of effective PACs are generally greater than 20 mg/L. |
| Granular activated carbon (GAC)          | High                    | –                          | Removal probable, more data required | Moderate removal of toxicity in saxitoxin equivalents<br>Depends on toxin variant, carbon, and period in use | Removal probable, more data required                   | Carbons with a large number of large pores provide best removal. Biodegradation influences the extent of toxin removal. Removal efficiency decreases with time. Natural organic matter will reduce effectiveness by occupying adsorption sites.  |
| Biological granular activated carbon     | High                    |                            |                                      |  |  | See GAC, biological activity enhances removal efficiency and bed life.   |

### 9.7.2.4 Drinking-water treatment for households and small communities

Domestic treatment of drinking-water has been a recent issue of concern in New Zealand. Many reticulated supplies provide excellent quality drinking-water and additional household treatment may actually cause deterioration rather than improvement. However, domestic treatment may have a role in regions supplied with poor quality drinking-water. Such treatment, using filtration, activated carbon and oxidation has shown a good removal of health hazards associated with cyanobacteria.

New (previously unused) point-of-use filter cartridges can achieve a removal of microcystin variants in the range 30–60 percent, and this degree of removal could be increased to about 90 percent by the passage of the water through three such filters. The removal may drop to 15 percent, however, by the time the filter is halfway through its expected life. The form of the cyanobacteria also has an influence on the efficiency of removal. A filter consisting of activated carbon and ion exchange resins may remove about 60 percent of the filamentous cyanobacteria, while up to 90 percent of the single cells pass through (eg, *Microcystis*). As with other filter systems, the death and lysis of cells retained on the filter creates a potential concern.

## 9.8 Recommended Reading

The Ministry for the Environment and the Ministry of Health published in 2009 the *New Zealand Guidelines for Cyanobacteria in Recreational Fresh Waters – Interim Guidelines*. This document contains material that is also relevant to managing and sampling drinking-water sources and is recommended to be consulted for additional scope.

In addition, Water Research Australia (WaterRA; formally the CRC for Water Quality) produces many reports and technical notes relevant to managing cyanobacteria in both recreational waters and drinking-water sources and is recommended to be consulted for additional scope. These reports can be found at: <https://www.waterra.com.au/publications/>. A readable fact sheet produced for the public and water managers was produced by WaterRA in 2015: <https://www.waterra.com.au/publications/document-search/?download=1172>.

Lopez et al (2008) produced one of the technical reports for the US Congress required by the Harmful Algal Bloom and Hypoxia Amendments Act of 2004, acknowledging that harmful algal blooms are one of the most scientifically complex and economically damaging issues challenging our ability to safeguard the health of the nation's aquatic and marine ecosystems.

A thorough Guidance Manual was published in 2009 for the Global Water Research Coalition (GWRC) by Water Quality Research Australia and SA Water – see references. This is recommended reading, as is WQRA (2010) which is probably easier to access.

WHO (2015) published a report on the management of cyanobacteria in water supplies. Also, in 2015 the AWWA/WRF published *A Water Utility Manager's Guide to Cyanotoxins*. Other useful documents include *Toxic Cyanobacteria in Water: A guide to*

*their public health consequences, monitoring and management* Chorus and Bartram (editors), published on behalf of the World Health Organization 1999. A publication in 2008 provides holistic coverage of cyanobacteria (Hudnell 2008), with a chapter on cyanotoxin removal during drinking-water treatment (Westrick 2008).

Greater Wellington Regional Council reported on the findings of a decade of monitoring and research on cyanobacterial blooms in regional rivers (GWRC 2016).

Scientific reviews specific to New Zealand toxic cyanobacteria have been published on benthic cyanobacteria that can grow in many New Zealand rivers (previously called *Phormidium autumnale* but now called *Microcoleus autumnalis*; McAllister et al 2016) and the cyanotoxin microcystins that frequently occurs in New Zealand lakes (Puddick et al 2019).

## Appendix 1: Chlorine C.t values for reducing microcystin-LR concentration to 1 µg/L in a batch or plug-flow reactor

| pH | Initial microcystin-LR concentration (µg/L) | C.t value (mg/L-min) |      |      |      |
|----|---|----------------------|------|------|------|
|    |   | 10°C                 | 15°C | 20°C | 25°C |
| 6  | 50  | 46.6                 | 40.2 | 34.8 | 30.3 |
|    | 10  | 27.4                 | 23.6 | 20.5 | 17.8 |
| 7  | 50  | 67.7                 | 58.4 | 50.6 | 44.0 |
|    | 10  | 39.8                 | 34.4 | 29.8 | 25.9 |
| 8  | 50  | 187                  | 161  | 140  | 122  |
|    | 10  | 110                  | 94.9 | 82.3 | 71.7 |
| 9  | 50  | 617                  | 526  | 459  | 399  |
|    | 10  | 363                  | 310  | 270  | 235  |

From USEPA (2015). Note that a C.t value of 50.6 is met if the FAC is 1.0 mg/L after 50.6 minutes; or 0.84 mg/L after 1 hour.

## Appendix 2: Detailed Case Study for the Use of the WHO/IPCS Framework to Assess Risk to Human

# Health from Exposure to Microcystins in Drinking-water

Excerpts from WHO (2017a).

Microcystins are a group of hepatotoxins produced by the cyanobacterium *Microcystis* and a range of other species. The basic structure consists of seven amino acids in a ring (cyclic heptapeptide) with molecular weights in the range 800–1100. Within this structure there can be modifications of all seven amino acids resulting in over 80 structural variants with a common mode of action. Microcystin-LR is the best characterised and among the most toxic of the congeners.

Blooms of microcystin-producing cyanobacteria in water bodies can contain more than one cyanobacterial strain or species and multiple variants of toxins. **What concentration of microcystins might consumers of drinking-water be exposed to?**

Concentrations of microcystins in drinking-water can be predicted from those found in untreated sources of drinking-water by applying expected reductions achieved by treatment processes and manipulation of water intakes. In some circumstances the depths of intakes into treatment plants or distribution systems can be varied to reduce toxin concentrations. This can be effective for species such as *Microcystis* and *Dolichospermum* (*Anabaena*) which produce surface blooms but less so for *Planktothrix* which can be more evenly spread in the water. Coagulation and filtration are effective in removing cyanobacterial cells and intracellular toxins while chlorine and other oxidising disinfectants are effective in reducing concentrations of extracellular toxins.

The concentration in drinking-water  $PEC_{dw}$  can be calculated using the following formula:

$$PEC_{dw} = \frac{RW \times (100-DR) \times (100-TR1) \times (100-TR2)}{100 \times 100 \times 100}$$

Where:

$PEC_{dw}$  is the predicted concentration in drinking-water ( $\mu\text{g/L}$ )

RW is the concentration in untreated water

DR is the reduction in concentration as a percentage by manipulating the intake depth

TR1 is the reduction in concentration as a percentage by treatment process 1 (eg, filtration)

TR2 is the reduction in concentration as a percentage by treatment process 2 (eg, chlorination).

To reflect a worst-case situation, conservative assumptions are made to determine maximum risk without variable depth intakes and inadequate or poorly managed treatment. In this example, a concentration of 55  $\mu\text{g/L}$  of microcystin-LR has been used which is at the upper end of concentrations detected in Lake Taihu in China (which has been subject to severe cyanobacterial blooms).

As there is a provisional WHO drinking water guideline value available for microcystin-LR, this can be used for risk characterisation. The estimated concentration of

microcystin-LR assuming no removal by treatment processes, 55 µg/L. This is clearly in excess of the provisional WHO guideline value for microcystin-LR of 1 µg/L. Therefore, further evaluation considering impacts of treatment on exposure assessment should be undertaken.

The case study used the following removal values:

- the reduction achieved by manipulation of the intake depth is 90 percent
- the reduction achieved by coagulation and filtration is 99.5 percent of whole cells
- in healthy blooms 90–95 percent of toxin is intracellular; based on this filtration can remove 90 percent of toxins
- in the latter stages of a bloom 50 percent of the toxin may be intracellular; based on this filtration can remove 50 percent of toxins
- providing that a chlorine contact time of at least 30 mg.min/L is achieved, chlorination can remove at least 98 percent of toxins remaining after filtration.

Using a deterministic approach and based on a conservative estimate of 50 percent of the toxin being intracellular the predicted concentration  $PEC_{dw}$  can be calculated as:

$$PEC_{dw} = \frac{55 \times (100-90) \times (100-50) \times (100-98)}{100 \times 100 \times 100} = 0.06 \mu\text{g/L}$$

The estimated drinking-water concentration of 0.06 µg/L in this scenario is well below the provisional WHO guideline value. Even if intake depth data was not available, further assessment would not be necessary as the estimated concentration of microcystins-LR in that case would be 0.6 µg/L, which is still below the WHO provisional guideline value.

## References

Ahern K, Ahern CR, Udy JW. 2008. In situ field experiment shows *Lyngbya majuscula* (cyanobacterium) growth stimulated by added iron, phosphorus and nitrogen. *Harmful Algae* 7: 389–404.

APHA, et al. 2005. *Standard Methods for the Examination of Water and Wastewater* (21st edition). Washington, DC: American Public Health Association, American Water Works Association, and Water Environment Federation.

AWWA/WRF. 2015. *A Water Utility Manager's Guide to Cyanotoxins*. 18 pp. American Water Works Assn and Water Research Foundation. Denver.  
<http://www.waterrf.org/PublicReportLibrary/4548a.pdf>.

Azavedo SM, Carmichael WW, Jochimsen EM, et al. 2002. Human intoxication by microcystins during renal dialysis treatment in Caruaru-Brazil. *Toxicology* 181–2: 441–6.

Backer LC. 2002. Cyanobacterial harmful algal blooms (CyanoHABs): Developing a public health response. *Lake and Reservoir Management* 18: 20–31.

Baldwin DS, Gigney H, Wilson JS, et al. 2008. Drivers of water quality in a large water storage reservoir during a period of extreme drawdown. *Water Research* 42: 4711–24.

Bayer TK, Schallenberg M, Martin CE. 2008. Investigation of nutrient limitation status and nutrient pathways in Lake Hayes, Otago, New Zealand: a case study for integrated lake assessment. *New Zealand Journal of Marine and Freshwater Research* 42: 285–95.x

Biggs BJ, Kilroy C. 2000. *Stream Periphyton Monitoring Manual*. Christchurch: NIWA.

Brylinsky M. 2012. Evaluation of two test kits for measurement of microcystin concentrations. Prepared for Nova Scotia Department of the Environment.

<https://www.epa.gov/sites/production/files/2014-08/documents/microcystins-testkit-novascotia.pdf>.

Burch MD. 2008. Effective dose, guidelines and regulations. In HK Hudnell (ed) *Cyanobacterial Harmful Algal Blooms: State of the science and research needs*. New York: Springer, pp 831–53.

Burger DF, Hamilton DP, Pilditch CA. 2008. Modelling the relative importance of internal and external nutrient loads on water column nutrient concentrations and phytoplankton biomass in a shallow polymictic lake. *Ecological Modelling* 211: 411–23.

Carmichael WW, Azevedo MFO, An JS, et al. 2001. Human Fatalities from Cyanobacteria: Chemical and Biological Evidence for Cyanotoxins. *Environmental Health Perspectives* 109(7): 663–8.

Cawthron Institute. 2005. *Preferred and Alternative Methods for Analysis and Characterisation of Cyanotoxins in Drinking-water*. Report No. 1044. Prepared for the Ministry of Health by S Wood and P Holland.

Cawthron Institute. 2015. Advice to inform the development of a benthic cyanobacteria attribute. Prepared for Ministry for the Environment. Cawthron Report No. 2752. 91 p. <http://www.mfe.govt.nz/sites/default/files/media/Fresh%20water/development-of-a-benthic-cyanobacteria-attribute.pdf>.

Cawthron Institute. 2018. Drivers of *Phormidium* Blooms in Southland Rivers and the Development of a Predictive Model. Envirolink Project CAWX1701 / 1805-ESRC280. 41 pp. <http://www.envirolink.govt.nz/assets/Uploads/1782-ESRC280-Drivers-of-Phormidium-blooms-in-Southland-rivers-and-the-development-of-a-predictive-model.pdf>.

Cawthron. 2018. Summary of a review workshop on the 'New Zealand guidelines for cyanobacteria in recreational fresh waters'. Cawthron Institute, for Ministry for the Environment. 113 pages.

Chorus I, Bartram J (eds). 1999. *Toxic Cyanobacteria in Water: A guide to their public health consequences, monitoring and management*. London: E & FN Spon. Published on behalf of the World Health Organization. [http://www.who.int/water\\_sanitation\\_health/resourcesquality/toxiccyanbact/en/](http://www.who.int/water_sanitation_health/resourcesquality/toxiccyanbact/en/).

Chorus I. 2005. *Current Approaches to Cyanotoxin Risk Assessment, Risk Management and Regulations in Different Countries*. WaBoLu 02/05. Umweltbundesamt, Dessau, Germany. 122 pp.

Chorus I. 2012. *Current approaches to cyanotoxin risk assessment, risk management and regulations in different countries*. Published by Federal Environment Agency (Umweltbundesamt). 151 pp.

<http://www.umweltbundesamt.de/sites/default/files/medien/461/publikationen/4390.pdf>.

Cox PA, Banask SA, Murch SJ. 2003. Biomagnification of cyanobacterial neurotoxins and neurodegenerative disease among the Chamorro people of Guam. *Proc Natl Acad Sci USA* 100: 13380–3.

CRCWQT. 2002. *Registered Products for Use Against Algae and Cyanobacteria in Dams, Potable Water and Irrigation Water Supply Systems, in Australia*. The Cooperative Research Centre for Water Quality and Treatment, Australia. 6 pp.  
<http://www.environment.gov.au/water/publications/quality/blue-green-algae-and-water-quality-fs.html>.

CRCWQT. 2008. *Blue Green Algae: A guide*. Drinking water facts. Issue 3. Cooperative Research Centre for Water Quality and Treatment, Australia. 4 pp. Accessed April 2015 at [http://www.waterra.com.au/\\_dyn/media/r385/system/attrib/file/326](http://www.waterra.com.au/_dyn/media/r385/system/attrib/file/326).

Domingos P, Rubim TK, Molica RJR, et al. 1999. First report of microcystin production by picoplanktonic cyanobacteria isolated from a northeast Brazilian drinking water supply. *Environ Toxicol* 14: 31–5.

Downs T, Schallenberg M, Burns C. 2008. Responses of lake phytoplankton to micronutrient enrichment: a study in two New Zealand lakes and an analysis of published data. *Aquatic Sciences* 70: 347–60.

Drikas M, Newcombe G, Nicholson B. 2001. *Water Treatment Options for Cyanobacteria and their Toxins*. AWWA Water Quality Technology Conference, Nashville, Tennessee.

Echenique-Subiabre, I., M. Tenon, J.-F. Humbert, and C. Quiblier. 2018a. Spatial and temporal variability in the development and potential toxicity of Phormidium biofilms in the Tarn River, France. *Toxins* 10:418.

GWRC. 2009. *Global Water Research Coalition International Guidance Manual for the Management of Toxic Cyanobacteria*. Dr G Newcombe (editor), SA Water Corporation. 107 pp. <https://www.waterra.com.au/cyanobacteria-manual/PDF/GWRCGuidanceManualLevel1.pdf>.

GWRC. 2016. Benthic cyanobacteria blooms in rivers in the Wellington Region. Findings from a decade of monitoring and research. MW Heath and S Greenfield. 118 pp.  
<http://www.gw.govt.nz/assets/council-publications/REPORT-Benthic-cyanobacteria-blooms-in-rivers-in-the-Wellington-Region-A-decade-of-monitoring-and-research.pdf>.

Hamill KD. 2001. Toxicity in benthic freshwater cyanobacteria (blue-green algae) first observations in New Zealand. *New Zealand Journal of Marine and Freshwater Research* 35: 1057–9.

Hart, D. D., B. J. Biggs, V. I. Nikora, and C. A. Flinders. 2013. Flow effects on periphyton patches and their ecological consequences in a New Zealand river. *Freshwater Biology* 58:1588-1602.

Hawkins PR, Runnegar MTC, Jackson ARB, et al. 1985. Severe hepatotoxicity caused by tropical cyanobacterium (blue-green alga) *Cylindrospermopsis raciborskii* (Woloszynska) Seenaya and Subba Raju isolated from a domestic water supply reservoir. *Appl Environ Microbiol* 50(5): 1292–5.

- Health Canada. 2011. *Evaluation of Field Test Kits to Detect Microcystins: 2010 study*. Exposure and Biomonitoring Division Health Canada. 21 pages. <https://www.epa.gov/sites/production/files/2014-08/documents/microcystins-testkit-canada.pdf>.
- Health Stream. 2018. Cyanobacteria and Climate Change. *Public Health Bulletin of Water Research Australia Limited*.
- Health Canada. 2000, edited 2002. *Cyanobacterial Toxins – Microcystin-LR*. Guidelines for Canadian Drinking Water Quality: Supporting Documentation. 22 pp. [http://hc-sc.gc.ca/ewh-semt/alt\\_formats/hecs-sesc/pdf/pubs/water-eau/cyanobacterial\\_toxins/cyanobacterial\\_toxins-eng.pdf](http://hc-sc.gc.ca/ewh-semt/alt_formats/hecs-sesc/pdf/pubs/water-eau/cyanobacterial_toxins/cyanobacterial_toxins-eng.pdf).
- Heath MW, Wood SA. 2010. Benthic Cyanobacteria and Anatoxin-a and Homoanatoxin-a Concentrations in Five Southland Rivers. Cawthron Report No. 1841. 15 pp plus appendices. <http://www.es.govt.nz/media/7945/southland-cyanobacteria-report-2010.pdf>.
- Heath, M. W., S. A. Wood, and K. G. Ryan. 2011. Spatial and temporal variability in *Phormidium* mats and associated anatoxin-a and homoanatoxin-a in two New Zealand rivers. *Aquatic Microbial Ecology* 64:69.
- Heath, M., S. A. Wood, K. Brasell, R. Young, and K. Ryan. 2015. Development of habitat suitability criteria and in-stream habitat assessment for the benthic cyanobacteria *Phormidium*. *River Research and Applications* 31:98-108.
- Heresztyn T, Nicholson BC. 1997. Nodularin concentrations in Lakes Alexandria and Albert, South Australia, during a bloom of the cyanobacterium (blue-green alga) *Nodularia spumigena* and degradation of the toxin. *Environ Toxicol Water Qual* 12: 74–282.
- Hitzfeld BC, Höger SJ, Dietrich DR. 2000. Cyanobacterial toxins: removal during drinking-water treatment, and human risk assessment. *Environ Health Perspect* 108(Suppl 1): 113–22.
- Hudnell HK (ed). 2008. *Cyanobacterial Harmful Algal Blooms: State of the science and research needs*. New York: Springer.
- IARC. 2010. *Ingested Nitrate and Nitrite, and Cyanobacterial Peptide Toxins*. Meeting of 14–21 June 2006. Vol 94. 464 pp. <http://monographs.iarc.fr/ENG/Monographs/vol94/mono94.pdf>.
- Jochimsen EM, Carmichael WW, An J, et al. 1998. Liver failure and death after exposure to microcystins at a haemodialysis center in Brazil. *New Engl J Med* 338: 873–8.
- Jones GJ, Burch M, Falconer I, et al. 1993. *Cyanobacterial Toxicity*. Technical Advisory Group Report, Murray-Darling Basin Commission Algal Management Strategy, MDBC, Canberra, pp 17–32.
- Keleti G, Sykora JL, Libby EC, et al. 1979. Composition and biological properties of lipopolysaccharides isolated from *Schizothrix calcicola* (Ag.) Gomont (cyanobacteria). *Appl Environ Microbiol* 38: 471–7.



Kobayashi T, Ryder DS, Gordon G, et al. 2008. Short-term response of nutrients, carbon and planktonic microbial communities to floodplain wetland inundation. *Aquatic Ecology* 1–16; DOI: 10.1007/s10452-008-9219-2, Thursday 20 November.

Kouzminov A. 2001. Personal communication from Dr David Stirling and Dr Penny Truman, Biotoxin Research Scientists, ESR, Kenepuru Science Centre.

Lahti K, et al. 2001. Occurrence of microcystins in raw water sources and treated drinking water of Finnish waterworks. *Water Science and Technology* 43: 225–8.

Leigh C, Burford MA, Roberts DT, et al. 2010. Predicting the vulnerability of reservoirs to poor water quality and cyanobacterial blooms. *Water Research* 44(15): 4487–96.

Li R, Carmichael WW, Brittain SM, et al. 2001. First report of the cyanotoxins cylindrospermopsin and deoxycylindrospermopsin from *Raphidiopsis curvata* (Cyanobacteria). *Jnl Phycology* 37: 1121–6.

Lippy EC, Erb J. 1976. Gastrointestinal illness in Sewickley, PA. *J Am Water Works Assoc* 68: 606–10.

Lopez CB, Jewett EB, Dortch Q, et al. 2008. *Scientific Assessment of Freshwater Harmful Algal Blooms*. Interagency Working Group on Harmful Algal Blooms, Hypoxia, and Human Health of the Joint Subcommittee on Ocean Science and Technology. Washington, DC. 78 pp.

<https://www.whitehouse.gov/sites/default/files/microsites/ostp/frshh2o0708.pdf>.

McAllister, T. G., S. A. Wood, and I. Hawes. 2016. The rise of toxic benthic *Phormidium* proliferations: A review of their taxonomy, distribution, toxin content and factors regulating prevalence and increased severity. *Harmful Algae* 55:282–294.

McAllister, T. G., S. A. Wood, J. Atalah, and I. Hawes. 2018a. Spatiotemporal dynamics of *Phormidium* cover and anatoxin concentrations in eight New Zealand rivers with contrasting nutrient and flow regimes. *Science of the Total Environment* 612:71–80.

McAllister, T. G., S. A. Wood, M. J. Greenwood, F. Broghammer, and I. Hawes. 2018b. The effects of velocity and nitrate on *Phormidium* accrual cycles: a stream mesocosm experiment. *Freshwater Science* 37:496–509.

McAllister, T. G., S. A. Wood, E. M. Mackenzie, and I. Hawes. 2019. Reach and mat scale differences in *Microcoleus autumnalis* (cyanobacterium) accrual along velocity and nitrate gradients in three New Zealand rivers. *Canadian Journal of Fisheries and Aquatic Sciences*, 77: 401–412.

Ministry for the Environment, Ministry of Health. 2009. *New Zealand Guidelines for Cyanobacteria in Recreational Fresh Waters – Interim Guidelines*. Prepared for the Ministry for the Environment and the Ministry of Health by SA Wood, DP Hamilton, WJ Paul, et al. Wellington: Ministry for the Environment. See <http://www.mfe.govt.nz/publications/water/guidelines-for-cyanobacteria/index.html>.

Ministry of Health. *Public Health Risk Management Plan Guide PHRMP Ref. P4.1. Pretreatment Processes – Algicide Application*. Wellington: Ministry of Health. The New Zealand Ministry of Health's Guides for drinking-water supplies can be accessed as Word documents on the Ministry of Health website: <http://www.health.govt.nz/water> then select publications and Water Safety Plans.

Ministry of Health. 2005. *Drinking-water Standards for New Zealand 2005*. Wellington: Ministry of Health. Revised 2008.

Ministry of Health. *Register of Recognised Laboratories for Drinking-Water Supplies*. Website: [www.health.govt.nz/water](http://www.health.govt.nz/water), select Publications.

Namikoshi M, Rinehart KL, Sakai R, et al. 1992. Identification of 12 hepatotoxins from a Homer Lake bloom of the cyanobacteria *Microcystis aeruginosa*, *Microcystis viridis*, and *Microcystis wesenbergii*: Nine new microcystins. *J Org Chem* 57: 866–72.

Newcombe G, et al. 2015. *Optimizing Conventional Treatment for the Removal of Cyanobacteria and Toxins*. Report 4315. Water Research Foundation (USA). [http://www.waterrf.org/ExecutiveSummaryLibrary/4315\\_ProjectSummary.pdf](http://www.waterrf.org/ExecutiveSummaryLibrary/4315_ProjectSummary.pdf).

NHMRC/ARMCANZ. 1996. *Australian Drinking Water Guidelines*. National Health and Medical Research Council, and Agriculture and Resource Management Council of Australia and New Zealand, Canberra. Also see 2011 edition at <http://www.nhmrc.gov.au/guidelines/publications/eh52>.

NICNAS. 2014. Phoslock™. Existing Chemical Secondary Notification Assessment Report NA/899S. Australian Govt., Dept of Health. National Industrial Chemicals Notification and Assessment Scheme. 130 pp. <http://www.ag.gov.au/cca>.

Nokes C. 2010. *Cyanobacteria and Cyanotoxins 2009–2010 Review*. ESR Client Report FW 10058, prepared for the Ministry of Health. Christchurch Science Centre.

Oliver, R. L., Hamilton, D. P., Brookes, J. D., & Ganf, G. G. (2012). Physiology, blooms and prediction of planktonic cyanobacteria. In B.A. Whitton (Ed.), *Ecology of Cyanobacteria II: their Diversity in Space and Time*. (pp. 155-194). Netherlands: Springer-Verlag.

Oudra B, Loudiki M, Vasconcelos V, et al. 2002. Detection and quantification of microcystins from cyanobacteria strains isolated from reservoirs and ponds in Morocco. *Environ Toxicol* 17: 32–9.

Perrson PE. 1983. Off-flavors in aquatic ecosystems – an introduction. *Wat Sci Technol* 15: 1–11.

Pilotto LS, Douglas RM, Burch MD, et al. 1997. Health effects of exposure to cyanobacteria (blue-green algae) during recreational water-related activities. *Aust NZ J Public Health* 21: 562–6.

Podivinsky E, Williamson WM. 2009. *Environmental Microbiological Risk Assessment and Management (EMRAM): Cyanobacteria and Cyanotoxins 2008–2009 Review*. ESR Client Report FW09076 (prepared for the Ministry of Health), Christchurch Science Centre.

Pomati F, Sacchi S, Neilan BA. 2000. The freshwater cyanobacterium *Planaktothrix* sp. FP1: molecular identification and detection of paralytic shellfish poisoning toxins. *J Phycology* 36: 553–62.

Puddick J, Thomson-Laing G, Wood SA 2019. Microcystins in New Zealand: A review of occurrence, congener diversity and cell quotas. *New Zealand Journal of Botany* 57: 93-111.

Queensland Government. 2002. *Queensland Harmful Algal Bloom Response Plan, Australia*. [http://www.nrw.qld.gov.au/water/blue\\_green/pdf/multi\\_agency\\_hab\\_plan\\_v1.pdf](http://www.nrw.qld.gov.au/water/blue_green/pdf/multi_agency_hab_plan_v1.pdf).

- Queensland Government. 2004. *Queensland Harmful Algal Bloom Operation Procedures – Appendix 3, Australia*.
- Redden AM, Rukminasari N. 2008. Effects of increases in salinity on phytoplankton in the Broadwater of the Myall Lakes, NSW, Australia. *Hydrobiologia* 608: 87–97.
- Ressom R, Soong FS, Fitzgerald J, et al. 1994. *Health Effects of Toxic Cyanobacteria (Blue-green Algae)*. National Health and Medical Research Council, Canberra, 108 pp.
- Ryan NJ, Mitrovic SM, Bowling LC. 2008. Temporal and spatial variability in the phytoplankton community of Myall Lakes, Australia, and influences of salinity. *Hydrobiologia* 608: 69–86.
- Schembri MA, Neilan BA, Saint CP. 2001. Identification of genes implicated in toxin production in the cyanobacterium *Cylindrospermopsis raciborskii*. *Environ Toxicol* 16: 413–21.
- Schneider, S. C. 2015. Greener rivers in a changing climate?—Effects of climate and hydrological regime on benthic algal assemblages in pristine streams. *Limnological-Ecology and Management of Inland Waters* 55:21-32.
- Shaw EC, Gabric AJ, McTainsh GH. 2008. Impacts of aeolian dust deposition on phytoplankton dynamics in Queensland coastal waters. *Marine and Freshwater Research* 59: 951–62.
- Smith KF, Lester PJ. 2006. Cyanobacterial blooms appear to be driven by top-down rather than bottom-up effects in the Lower Karori Reservoir (Wellington, New Zealand). *New Zealand Journal of Marine and Freshwater Research* 40: 53–63.
- Stanford, B.D., Adams, C., Rosenfeldt, E.J., Arevalo, E. and Reinert, A. (2016), CyanoTOX: Tools for Managing Cyanotoxins in Drinking Water Treatment With Chemical Oxidants. *Journal of the American Water Works Association*, 108: 41-46.
- Stevens DK, Krieger RI. 1991. Stability studies on the cyanobacterial nicotinic alkaloid anatoxin-A. *Toxicon* 29: 167–79.
- Stirling DJ, Quilliam MA. 2001. First report of the cyanobacterial toxin cylindrospermopsin in New Zealand. *Toxicon* 39: 1219–22.
- Teixera M da GLC, Costa M da CN, de Carvalho VLP, et al. 1993. Gastroenteritis epidemic in the area of the Itaparica Dam, Bahia, Brazil. *Bulletin of the Pan American Health Organisation* 27: 244–53.
- Ueno Y, Nagata S, Tsutsumi T, et al. 1996. Detection of microcystins, a blue-green algal hepatotoxin, in drinking water sampled in Haimen and Fusui, endemic areas of primary liver cancer in China, by highly sensitive immunoassay. *Carcinogenesis* 17: 1317–21.
- USEPA. 2015. Recommendations for public water systems to manage cyanotoxins in drinking water. EPA 815-R-15-010. 70 pp.  
<https://www.epa.gov/sites/production/files/2017-06/documents/cyanotoxin-management-drinking-water.pdf>.
- USEPA. 2015a. Drinking Water Health Advisory Documents for Cyanobacterial Toxins. <https://www.epa.gov/ground-water-and-drinking-water/drinking-water-health-advisory-documents-cyanobacterial-toxins>. Note: this link leads to the Drinking Water Health Advisory for the Cyanobacterial Toxin Cylindrospermopsin; Drinking

Water Health Advisory for the Cyanobacterial Microcystin Toxins; and the Health Effects Support Documents for Anatoxin-A, Cylindrospermopsin and Microcystins.

USEPA. 2016. *Water treatment optimization for cyanotoxins – Version 1*. US EPA Office of Water: EPA 810-B-16-007. 34 p plus appendices

van Apeldoorn ME, van Egmond HP, Speijers GJA, et al. 2007. Toxins of cyanobacteria. *Molecular Nutrition & Food Research* 51: 7–60.

WRF. 2018. Four steps to effective cyanotoxin communications: a risk communications toolkit. Water Research Foundation. 50 pp.

<http://www.waterrf.org/PublicReportLibrary/4697.pdf>.

Westrick JA. 2008. Cyanobacterial toxin removal in drinking water treatment processes and recreational waters. In HK Hudnell (ed) *Cyanobacterial Harmful Algal Blooms: State of the science and research needs*. New York: Springer, pp 277–90.

WHO. 1997. *Cyanobacteria, Their Toxins, Water and Health*. Report on a World Health Organization Editorial Meeting, Bad Elster, Germany, 10–15 November.

WHO. 2003. *Guidelines for Safe Recreational Water Environments*. Volume 1: Coastal and fresh waters. Chapter 8: Algae and cyanobacteria in fresh water.

ISBN 92 4 154580 1. Available at:

[http://www.who.int/water\\_sanitation\\_health/bathing/srwe1execsum/en/index.html](http://www.who.int/water_sanitation_health/bathing/srwe1execsum/en/index.html).

WHO. 2004. *Guidelines for Drinking-water Quality 2004* (3rd edition). Geneva: World Health Organization. Available at:

[www.who.int/water\\_sanitation\\_health/dwq/gdwq3/en/print.html](http://www.who.int/water_sanitation_health/dwq/gdwq3/en/print.html) see also the addenda.

WHO. 2011. *Guidelines for Drinking-water Quality 2011* (4th edition). Geneva: World Health Organization. Available at:

[http://www.who.int/water\\_sanitation\\_health/publications/2011/dwq\\_guidelines/en/index.html](http://www.who.int/water_sanitation_health/publications/2011/dwq_guidelines/en/index.html).

WHO. 2015. *Management of Cyanobacteria in Drinking-water Supplies: Information for regulators and water suppliers*. WHO/FWC/WSH/15.03. 12 pp.

[http://www.who.int/water\\_sanitation\\_health/dwq/cyanobacteria\\_in\\_drinking-water.pdf](http://www.who.int/water_sanitation_health/dwq/cyanobacteria_in_drinking-water.pdf).

WHO. 2017. *Guidelines for Drinking-water Quality: Fourth edition incorporating the first Addendum*. Geneva: World Health Organization. 631 pp.

[http://www.who.int/water\\_sanitation\\_health/publications/drinking-water-quality-guidelines-4-including-1st-addendum/en/](http://www.who.int/water_sanitation_health/publications/drinking-water-quality-guidelines-4-including-1st-addendum/en/).

WHO. 2017a. *Chemical Mixtures in Source Water and Drinking-water*. Geneva: World Health Organization. Licence: CC BY-NC-SA 3.0 IGO. 104 pp.

[http://www.who.int/water\\_sanitation\\_health/publications/chemical-mixtures-in-water/en/](http://www.who.int/water_sanitation_health/publications/chemical-mixtures-in-water/en/).

Wood SA. 2005. *Bloom Forming and Toxic Cyanobacteria in New Zealand: Species diversity, distribution, cyanotoxin production and accumulation of microcystins in selected freshwater organisms*. PhD thesis. Wellington: Victoria University and Massey University, 310 pp.

- Wood SA, Stirling DJ. 2003. First identification of the cylindrospermopsin producing cyanobacteria *Cylindrospermopsis raciborskii* in New Zealand. *New Zealand Journal of Marine & Freshwater Research* 37(4): 821–8.
- Wood SA, Holland PT, Stirling DJ, et al. 2006. Survey of cyanotoxins in New Zealand water bodies between 2001 and 2004. *New Zealand Journal of Marine and Freshwater Research* 40: 585–97.
- Wood SA, Holland PT, McNabb P, et al. 2007. *Toxic Benthic Cyanobacteria: An underestimated risk for New Zealand drinking water supplies?* 10 pp. Cawthron Institute.
- Wood SA, Holland P, MacKenzie L. 2010. *Early Warning of Anatoxin Contamination in River Water: SPATT field trials*. Cawthron Report 1747, prepared for Southland Regional Council. 23 pp. [www.envirolink.govt.nz](http://www.envirolink.govt.nz).
- Wood SA, Wagenhoff A, Young R. 2014. *The effects of river flow and nutrients on Phormium abundance and toxin production in rivers of the Manawatu-Whanganui Region*. Cawthron Institute Report 2575, prepared for Horizons Regional Council. 55 pp. [www.envirolink.govt.nz](http://www.envirolink.govt.nz).
- Wood, S. A., C. Depree, L. Brown, T. McAllister, and I. Hawes. 2015. Entrapped sediments as a source of phosphorus in epilithic cyanobacterial proliferations in low nutrient rivers. *PLoS One* 10: e0141063.
- Wood, S. A., J. Atalah, A. Wagenhoff, L. Brown, K. Doehring, R. G. Young, and I. Hawes. 2017. Effect of river flow, temperature, and water chemistry on proliferations of the benthic anatoxin-producing cyanobacterium *Phormidium*. *Freshwater Science* 36:63-76.
- Wood, S. A., Biessy, L., & Puddick, J. 2018. Anatoxins are consistently released into the water of streams with *Microcoleus autumnalis*-dominated (cyanobacteria) proliferations. *Harmful algae*, 80: 88-95.
- WQRA. 2012. *Alternative and Innovative Methods for Source Water Management of Algae and Cyanobacteria [Project #4094]*. Water Research Australia. <http://www.waterra.com.au/>.
- WQRA. 2010. *Management Strategies for Cyanobacteria (Blue-Green Algae) and their Toxins: A guide for water utilities*. Research Report 74. 112 pp. <http://www.waterra.com.au/publications/featured-publications/>.
- WRA. 2013. *Evaluation of Integrated Membranes for Taste and Odour and Algal Toxin Control*. Project 1003/08; Leader G Newcombe, AWQC. <http://www.waterra.com.au/>.
- WRF. 2016. *Managing Cyanotoxins in Drinking Water: A technical guidance manual for drinking water professionals*. AWWA/WRF. 67 pp. <http://www.waterrf.org/PublicReportLibrary/4548b.pdf>.
- WRF. 2016a. *Management of Treatment Sludge Impacted by Cyanobacteria*. Water Research Foundation. Advances in Water Research. July–September. <http://www.advancesinwaterresearch.org/awr/20160709?pg=20#pg20>.

# Chapter 10: Chemical compliance

## Contents

|             |  |           |
|-------------|--|-----------|
| <b>10.1</b> | <b>Introduction</b>  | <b>2</b>  |
| 10.1.1      | Maximum Acceptable Value (MAV)   | 3         |
| <b>10.2</b> | <b>Chemical determinands of health significance</b>  | <b>4</b>  |
| 10.2.1      | Background   | 4         |
| 10.2.2      | Inorganic chemicals of health significance   | 7         |
| 10.2.3      | Organic determinands of health significance and pesticides                                       | 10        |
| 10.2.4      | Health risk from toxic chemicals   | 16        |
| 10.2.5      | Derivation of MAVs for chemicals of health significance  | 18        |
| 10.2.6      | Plumbosolvent water  | 31        |
| <b>10.3</b> | <b>Monitoring programme design</b>   | <b>34</b> |
| 10.3.1      | Drinking-water Standards for New Zealand   | 34        |
| 10.3.2      | Priority 2a and 2b chemical determinands   | 36        |
| 10.3.3      | Plumbosolvent water  | 45        |
| 10.3.4      | Discretionary monitoring   | 48        |
| <b>10.4</b> | <b>Sampling procedures and techniques</b>  | <b>55</b> |
| 10.4.1      | Chemical determinands  | 55        |
| 10.4.2      | Plumbosolvent water  | 59        |
| <b>10.5</b> | <b>Analytical details</b>  | <b>60</b> |
| 10.5.1      | Chemical determinands  | 60        |
| 10.5.2      | Laboratory competency  | 64        |
| 10.5.3      | Interpretation of analytical data  | 65        |
| <b>10.6</b> | <b>Records and assessment of compliance</b>  | <b>65</b> |
| 10.6.1      | Example: Records and assessment of chemical compliance for Bogus community drinking-water supply | 65        |
| <b>10.7</b> | <b>Response to transgressions</b>  | <b>69</b> |

|  |           |
|--|-----------|
| <b>Appendix: Sampling requirements</b> | <b>71</b> |
|--|-----------|

|                   |           |
|-------------------|-----------|
| <b>References</b> | <b>76</b> |
|-------------------|-----------|

### List of tables

|   |    |
|---|----|
| Table 10.1: Data for calculating the Langelier Index          | 50 |
| Table A10.1: Inorganic determinands: sampling requirements    | 72 |
| Table A10.2: Cyanotoxins: sampling requirements               | 72 |
| Table A10.3: Organic determinands: sampling requirements      | 73 |
| Table A10.4: Pesticides: sampling requirements                | 74 |
| Table A10.5: Radiological determinands: sampling requirements | 75 |
| Table A10.6: Abbreviations used in Tables A10.1–A10.4         | 75 |

### List of figures

|   |    |
|---|----|
| Figure 10.1: Standard fitting for testing plumbosolvency                | 47 |
| Figure 10.2: Influence of water composition on meringue dezincification | 53 |

## 10.1 Introduction

As well as compliance issues, this chapter provides some information on the sources, occurrences, and management related to the chemical determinands covered by the *Drinking-water Standards for New Zealand 2005* (revised 2008) (DWSNZ). The World Health Organization's *Guidelines for Drinking-water Quality* have been drawn on extensively (WHO 2004a/2011).

This chapter discusses the current and potential risks of chemical contamination of drinking-water. Risks associated with or originating in the raw water are discussed in Chapter 3: Source Waters. This chapter explains the methods used to derive the Maximum Acceptable Values (MAVs) for chemical determinands of health significance and provides detailed information on how to apply the DWSNZ to these determinands. Section 10.2 addresses the basis of the changes to the MAVs from their earlier values.

Tables 2.2 and 2.3 in the DWSNZ list the MAVs for chemical determinands of health significance. Some chemical determinands that may affect water quality but have no health significance are discussed in Chapter 18: Aesthetic Considerations.

Some chemical determinands found in drinking-water are beneficial – see WHO (2005).

Information is given on the planning and implementation of monitoring programmes for chemical determinands and assessment of results according to the DWSNZ, and how and why to carry out discretionary monitoring. Examples are provided.

The individual chemical determinands are described in detail in the Datasheets in Volume 3. Many of these may have possible health or aesthetic concerns but do not have a MAV or a GV.

The removal of chemical determinands of health concern from water is discussed where possible in the individual datasheets, and in the various treatment chapters. For example, Chapter 13 includes a section on lime softening and ion exchange; Chapter 14 includes a section on the use of adsorption processes such as activated alumina and activated carbon. Section 19.3.4 of Chapter 19 covers point-of-use and point-of-entry treatment systems. AWWA (1995) discusses fluoridation; see full list of AWWA Standards on <http://www.awwa.org/files/Resources/Standards/StandardsSpreadsheet.xls>.

## 10.1.1 Maximum Acceptable Value (MAV)

The MAV of a chemical determinand is the concentration of that determinand which does not result in any significant risk to the health of a 70 kg consumer over a lifetime of consumption of two litres of the water a day.

For genotoxic carcinogens the MAV represents an excess lifetime cancer risk, usually amounting to one extra incidence of cancer per 100,000 people drinking water containing the determinand in question at the MAV for 70 years (ie, an assessed risk of  $10^{-5}$ ).

The MAVs (section 2 of the DWSNZ) provide the benchmark whereby the public health safety of the drinking-water is assessed, ie, if the determinands in the drinking-water occur at concentrations less than their MAV, the water is considered safe. The other sections of the DWSNZ describe how to demonstrate compliance with the DWSNZ.

The derivation of the MAVs is explained in the datasheets.

Some MAVs are called provisional. This may be because the WHO considered that the available data are not precise enough to develop a MAV, but that there are health concerns related to the determinand, so they derived a provisional guideline value. In some cases WHO (2004a) decided that some determinands no longer needed a guideline value; in most cases the 2005 DWSNZ retained the MAV but called it provisional. The 2008 revision deleted most of these. Some substances, eg, some pesticides, have more relevance in New Zealand so a provisional MAV was developed despite there being no WHO guideline value (eg, azinphos methyl), or a different guideline value (eg, 1080) in WHO (2004a).



In summary, a provisional MAV is an estimated safe value based on the best toxicological information available to date, but that limitations with the derivation of the value are acknowledged and there may be the need to revise this when new information arrives. Therefore provisional MAVs should be treated in the same way as other MAVs with regard to consequences of P2 status and exceedence.

Guidance values for short-term exposures (STEVs) are now being developed by the WHO, the USEPA and other organisations, for a small number of substances that are used in significant quantities and are frequently implicated in an emergency as a consequence of spills, usually to surface water sources. See sections 10.2.5.1 and 10.2.5.4. Where available, these values appear in the datasheets. The 2008 revision includes short-term MAVs for cyanide, nitrate and nitrite. STEVs will appear in the datasheets.

Drinking water standards in England and Wales are now set out in European and UK legislation. They are called Prescribed Concentrations or Values (PCVs). Many are different from the WHO Guideline Values (DWI 2010a). Where relevant, PCVs are shown in the datasheets.

The most commonly used method to test for compliance is by chemical analysis and comparison with the relevant MAVs. Most of the chemicals likely to be of concern have a MAV, but with more than 100,000 chemicals in commercial use and many more natural compounds, chemical testing of regulated chemicals alone may be insufficient to identify all potential hazards, so additional methods may be required. EnHealth (2012a) proposes that biological testing is also conducted as part of an integrated approach to assessment of water quality based on a weight-of-evidence approach. The options are discussed.

## 10.2 Chemical determinands of health significance

### 10.2.1 Background

With respect to chemical determinands, the current DWSNZ (2008 revision) arises from a revision of the DWSNZ published in 2000 and 2005. This revision incorporates current scientific, national and international information, based largely on WHO (2004a) and subsequent rolling revisions.

The DWSNZ lists over 100 chemical determinands with MAVs or PMAVs. Refer to the previous section and to Chapter 1: Introduction, section 1.6.2 for information about MAVs. Where relevant, the DWSNZ and the Australian Drinking Water Guidelines (NHMRC, NRMMC 2004/2011) have recalculated the WHO Guidelines Values (GV) to a 70 kg bodyweight basis from the 60 kg used by the WHO. This increase in body weight results in a nominal 16 percent increase in MAV values, however, this increase is not always apparent in the MAV because of rounding effects. As discussed below, some determinands are not dependent on adult body weight: some calculations are independent of bodyweight, and others, (lead, short-term nitrite and DDT and its isomers) are calculated using bodyweight and water consumption values for children or infants; details appear on the datasheets.

The WHO (2004a) guideline value lists include a number of provisional guideline values. These have been established based on the practical level of treatment achievability or analytical achievability. In these cases, the guideline value is higher than the calculated health-based value. Uncertainty in the toxicological basis for the guideline may also result in its designation as provisional.

The 2005 DWSNZ contained MAVs for 50 determinands not listed in WHO (2004a). These were given provisional MAVs. Most of these determinands are organic compounds, including a large number of pesticides. The basis for their inclusion was the assumption that registration of a pesticide for use in New Zealand may ultimately result in contamination of drinking-water supply. Where WHO (2004a) considered that a chemical determinand is unlikely to appear in drinking-water at a concentration of health significance, it has been removed from the DWSNZ 2008 revision, and datasheets have been modified or prepared accordingly.

New Zealand toxicologists recalculated the boron MAV (for the 2000 DWSNZ). It became 1.4 mg/L, cf the WHO GV of 0.5 mg/L. The basis for this difference is explained in the datasheet. Subsequent to the 2008 DWSNZ, WHO (in 2011) revised their GV for several determinands, eg, boron to 2.4 mg/L. The MoH has yet to devise an acceptable procedure for updating MAVs without having to rewrite the Standards, along with the extensive consultation period that the public seems to expect these days.

Because of the extensive list of determinands, a risk-based approach should be used to evaluate the health significance of these determinands in a particular water supply, using available information relating to contaminants likely to be present in the water supply catchment (see Chapter 3: Source Waters). Details on the derivations are provided in the datasheets.

The 2005 DWSNZ also included a table of determinands for which health concerns have been raised, but for which no MAVs have been set (Table A2.2, DWSNZ 2005). This table was removed from the 2008 revision, but information is retained (or expanded) in the datasheets.

WHO (2004a) notes that:

Only a few chemicals have been shown to cause widespread health effects in humans as a consequence of exposure through drinking-water when they are present in excessive quantities. These include fluoride and arsenic. Human health effects have also been demonstrated in some areas associated with lead (from domestic plumbing), and there is concern because of the potential extent of exposure to selenium and uranium in some areas at concentrations of human health significance. These constituents should be taken into consideration as part of any priority-setting process.

Drinking-water may be only a minor contributor to the overall intake of a particular chemical, and in some circumstances controlling the levels in drinking-water, at potentially considerable expense, may have little impact on overall exposure. Drinking-water risk management strategies should therefore be considered in conjunction with other potential sources of human exposure.

Guidance is provided in the supporting document *Chemical Safety of Drinking-water* (WHO 2004b) on how to undertake prioritisation of chemicals in drinking-water. This deals with issues including:

- the probability of exposure (including the period of exposure) of the consumer to the chemical
- the concentration of the chemical that is likely to give rise to health effects
- the evidence of health effects or exposure arising through drinking-water, as opposed to other sources, and relative ease of control of the different sources of exposure.

The application of a risk-based approach is addressed in Chapter 3: Source Waters in relation to assessing potential sources of contaminants.

Risk management issues related to trace organics and fluoridation are addressed in the:

- MoH Public Health Risk Management Plan Guide PHRMP Ref. P8.4: Treatment Processes – Trace Organics Removal, and in
- MoH Public Health Risk Management Plan Guide PHRMP Ref. P9: Treatment Processes – Fluoridation.

See also WHO 2007 *Chemical Safety of Drinking-water: Assessing priorities for risk management*.

The United Nations Environment Programme, International Labour Organisation and World Health Organization jointly sponsored a project within the International Programme on Chemical Safety (IPCS) on the harmonisation of approaches to the assessment of risk from exposure to chemicals. They produced a booklet *IPCS Risk Assessment Terminology* (IPCS 2004).

Personal care products and domestic cleaning products are a diverse range of products that contain vast numbers of different chemicals. These chemicals may have the potential to reach drinking water supplies via release into the environment through typical use and entry to sewerage and subsequent treatment. Published studies on the occurrence of these substances demonstrate that trace amounts can reach drinking water. DWI (2014a) assessed approximately 690 chemicals; thirty-three were identified during the data collation and prioritisation exercise as having a high potential for reaching drinking water supplies. The potential concentration of these chemicals in drinking water was then modelled. Ten of the thirty-three prioritised chemicals were predicted to produce levels of maximum exposure through drinking water and bathing close to or greater than would be anticipated through their intended use. Where relevant, further information is included in individual datasheets.

## 10.2.2 Inorganic chemicals of health significance

The inorganic determinands of health significance are listed in Table 2.2 of the DWSNZ. Of these chemicals, the ones most often occurring in health significant concentrations in New Zealand drinking-water supplies are metals from corrosion of fittings,<sup>1</sup> and arsenic, boron and nitrate. Arsenic and boron occur naturally in geothermal fluids or sometimes in association with marine sediments, whereas nitrate concentrations are increased by intensive agricultural activity.

The inorganic determinands of health significance listed in the DWSNZ are predominantly metals. These may be present in the source water or may enter the water in the distribution system, or from the plumbing.

The main natural contributors of metals to source water in New Zealand are geothermal fluids and the leaching of minerals and rocks. Natural sources, especially geothermal, are well known for arsenic, antimony and mercury, and may also be important in localised areas for lead. Generally these determinands can be avoided in the source water selection process; otherwise specialised treatment may be necessary. The USEPA has some useful information about arsenic at <http://water.epa.gov/lawsregs/rulesregs/sdwa/arsenic/compliance.cfm>

Leaching of contaminants from landfill sites or industrial contamination is a recognised source of metals to source waters, although uncommon in New Zealand.

Metals appearing in the source water may be present as free soluble ions, precipitated compounds, ions complexed with organic matter, or as compounds adsorbed on particles. Complexation with organic matter can present treatment problems for those metals that are conventionally removed by oxidation/precipitation, because of the difficulty in destroying the soluble complexes to allow oxidation and precipitation of the metal.

<sup>1</sup> Note that the legislative responsibility for drinking-water quality beyond the point of supply to a property comes under the Building Act 2004 ([http://www.med.govt.nz/buslt/bus\\_pol/building/review/](http://www.med.govt.nz/buslt/bus_pol/building/review/))

Dissolution of metals in the distribution system by corrosive water can lead to the concentrations of metals reaching the consumer being higher than was originally present in the raw water (eg, copper, lead, nickel). Sections 10.2.6, 10.3.3 and 10.3.4 discuss the effects of corrosion of plumbing materials further. In this situation aggressiveness (plumbosolvency), which has no MAV itself, has an indirect effect on the determinands of health significance. Corrosion products may result from the dissolution of pipes (eg, copper, lead), or solders used in plumbing joints (eg, iron, zinc, lead, cadmium, antimony). Internationally, the lead component of solder has reduced; for example, the Canadian Standard CSA B125.1 limited the lead content of solder to 0.2 percent in 1986. The National Plumbing Code of Canada officially prohibited lead solders from being used in new plumbing or in repairs to plumbing for drinking water supplies in the 1990. The most common replacements for lead solders are tin-antimony, tin-copper and tin-silver solders. In Australia plumbing products are required to be certified to WaterMark and AS/NZS 4020:2005; and/or have low lead content or be lead free, when renovating or building.

There have been suggestions that fluoridation accelerates corrosion; CDC (2013) states that water fluoridation will not increase water corrosion or cause lead to leach (dissolve) from pipes and household plumbing fixtures. Metals (eg, zinc, barium, lead) may also be leached from plasticisers or stabilisers in the polymeric materials used in many modern water systems (eg, vinyl chloride).

A MoH report (2012) includes results of 511 drinking water samples taken from schools that operate their own water supply; 41 percent of samples exceeded 50 percent of the MAV for lead. This was due to dissolution from the reticulation and/or in the case of roof catchment, from components of the rainwater collection system, such as lead-head nails, lead flashings and lead soldered storage tanks. The report itemised abatement options.

Some inorganic disinfection by-products are contained in Table 2.2 of the DWSNZ. Organic disinfection by-products were the first types of disinfection by-product found, and are still the predominant compounds that cause concern when chlorine is used for disinfection.

Monochloramine is produced as a by-product if ammonia is present in water being chlorinated. It may also be used as a disinfectant in its own right. Since the introduction of chlorine dioxide and ozone as disinfectants a number of new inorganic disinfection by-products arising from these disinfectants have also been identified. Inorganic by-products may arise from the reaction of the disinfectant with other inorganic or organic constituents in the water (bromate, chlorite), or as a by-product of the process used to generate the disinfectant (chlorate, chlorite). The inorganic disinfection by-product that has been identified most widely in New Zealand drinking waters is chlorate, which is most often present as a decomposition product of hypochlorite solutions.

Disinfectants and their by-products are discussed in Chapter 15: Treatment Processes, Disinfection. Most disinfection by-products have a datasheet.

The remaining compounds contained in Table 2.2 are a miscellaneous collection of non-metallic substances. They may be present in water from natural and agricultural sources (eg, nitrate/nitrite), sometimes of geothermal origin (eg, boron), from intentional addition as a preventive health measure (fluoride), or from contamination by human activities (eg, cyanide, nitrate/ nitrite).

Health Canada (2000) commissioned NSF International to review contaminant occurrences from chemicals used in water treatment. Several metals were listed, with lead being the most persistent offender. DWI (2013) published "Potential Contaminants in Drinking Water Treatment Chemicals: Final Report". DWI (2014) published "Brass fittings – A source of lead in drinking water". Many of the findings appear in the datasheet for lead.

DWI (2016) summarised a study of the leaching of lead and nickel from brass fittings. Amongst their finding were:

- low lead brass fittings (<0.25 percent lead) have been shown to yield less lead than corresponding 'high lead' brass fittings (2.0 percent to 3.5 percent lead)
- however, the low lead taps tested did yield relatively high quantities of nickel
- it was also found that the relatively high lead brass ferrules (up to 6.0 percent lead) were relatively low yielding
- it was demonstrated that phosphate dosing reduces leaching of nickel and zinc in addition to lead
- it was shown that high yields of lead and nickel come from new brass fittings, fittings that have been empty of water for some time and from fittings that have held stagnating water. Flushing before use is recommended for these situations.

Some inorganic determinands, when in low concentrations, may also have health implications, but do not currently have WHO GVs or DWSNZ MAVs. Chapter 12 of WHO (2005) discusses these. The main focus in setting standards has been on the toxicological properties of contaminants. Nevertheless, some studies have attempted to define the minimum content of essential elements or total dissolved solids (TDS) in drinking-water, and some countries have included requirements or guidelines for selected substances in their drinking-water regulations. The issue is relevant not only where drinking-water is obtained by desalination (if not adequately re-mineralised) but also where home treatment or central water treatment reduces the content of important minerals, eg, by softening, and when low-mineral bottled water is consumed.

Sufficient evidence is now available to confirm the health consequences from drinking-water deficient in calcium or magnesium. Many studies show that a higher content of magnesium in drinking-water is related to decreased risks for cardiovascular disease (CVD) and especially for sudden death from CVD. This relationship has been described independently in epidemiological studies with different study designs, performed in different areas, different populations, and at different times. The consistent epidemiological observations are supported by the data from autopsy, clinical, and animal studies. Biological plausibility for a protective effect of magnesium is substantial, but the specificity is less evident due to the multifactorial aetiology of CVD. In addition to an increased risk of sudden death, it has been suggested that intake of water low in magnesium may be associated with a higher risk of motor neuronal

disease, pregnancy disorders (so-called preeclampsia), sudden death in infants, and some types of cancer. Recent studies suggest that the intake of soft water, ie, water low in calcium, is associated with a higher risk of fracture in children, certain neurodegenerative diseases, pre-term birth and low weight at birth and some types of cancer. Furthermore, the possible role of water calcium in the development of CVD cannot be excluded. It is possible that as more information becomes available, recommended minimum levels will be established for some determinands.

Most New Zealand water supplies are taken from surface sources and most contain relatively low levels of calcium and magnesium compared with European and North American supplies. WHO (2005) suggests a minimum for magnesium of 10 mg/L and for calcium, a minimum of 20 mg/L. Typical surface water supplies in New Zealand contain about 2 mg/L Mg and 12 mg/L Ca.

## 10.2.3 Organic determinands of health significance and pesticides

### Introduction

A large number of organic determinands of health significance has been identified in drinking-waters around the world.

Pesticides and other organic determinands with MAVs have been tabulated together in Table 2.3 of the DWSNZ. Not all of the determinands listed in Table 2.3 were being used in New Zealand at the time the DWSNZ were prepared. They are included to cover the possibility of their use in the future. Others, such as DDT and its isomers and dieldrin, are no longer registered for use in New Zealand. As a result, there are still a few stockpiles of unused pesticides in various parts of the country. These stockpiles, and residues in soil, are a potential contributor of pesticides to source waters of drinking-water supplies, so MAVs for these compounds have been retained.

### Adsorption

Some pesticides and other organic determinands can be removed from water by adsorption techniques. The most common treatment process uses powdered or granular activated carbon. This is discussed in Chapter 14.

### Aeration

Air stripping involves the transfer of volatile compounds from water to air. The higher the vapour pressure of the compound the more it is amenable to air stripping. Consequently, air stripping is the technology of choice for compounds with high Henry's law constant (high vapour pressure and low solubility in water). Henry's law constants can be called air-water partition coefficients. There are several types of air stripping devices which provide high exchange surface area (interface) between water and air, with low energy consumption, to facilitate the mass transfer of the VOCs from water to air. WRF (2014) reports the results of aeration trials on the removal of several volatile organic contaminants from water. The VOCs' removal efficiencies were studied

by collecting operational data from pilot plant operations, under various air-to-water ratios (53–652), three different temperatures (4, 12, and 20°C), and 1 to 6 trays in series. Henry's law constants can be found at <http://www.henrys-law.org/henry-3.0.pdf>. Aeration is also discussed briefly in Chapters 12 and 18.

Some groundwaters have been found to contain traces of the more persistent pesticides that were formerly used in New Zealand but which have been withdrawn from use for some years. Other organic contaminants, such as pentachlorophenol (PCP), may leach to groundwater or surface waters from (now disused) timber treatment sites and storage areas, just as PAHs have raised concerns at old coal gas plants.

Pesticides have several properties that affect their ability to leach to groundwater, as follows:

### K<sub>oc</sub>

This property refers to how tightly and quickly the pesticide binds to organic particles in the soil. A higher number indicates a greater tendency for the pesticide to bind to organic matter and thus a lesser tendency to leach with the soil water.

### Persistence (T<sub>50</sub>)

Pesticides are degraded primarily by sunlight, soil microbes, and chemicals in the soil. The combination of these factors determines persistence, or how long the pesticide remains in the soil. Persistence is usually measured in terms of half-life (T<sub>50</sub>), or the time it takes for half of the applied chemical to break down. The greater the persistence of a pesticide, the more likely it is to leach to groundwater.

### Rate of application (R)

Different amounts of each pesticide are required to control target weeds, insects, or diseases. Generally, the chance of leaching increases when pesticides are applied at a higher rate.

### Application method (F)

Pesticides may be incorporated into the soil by mixing, applied to the soil surface, or applied to growing plants or seeds. To leach through the soil, a chemical first has to reach the soil. Pesticides applied to plants can be absorbed by the plant or broken down by sunlight, reducing the potential for leaching. Pesticides applied to the soil surface can also be broken down by sunlight before reaching the soil surface. Of the three methods of application, soil incorporation provides the greatest opportunity for leaching because all of the chemical is placed in the soil.

$$\text{Pesticide Leaching Potential (PLP)} = (T_{50} \times R \times F) / K_{oc}$$

A table of leaching potentials for several common pesticides has been published by North Carolina Cooperative Extension Service, see References.



## Persistent organic pollutants (POPs)

POPs are chemicals that:

- are extremely stable and persist in the environment
- bio-accumulate in organisms and food chains
- are toxic to humans and animals and have chronic effects such as disruption of reproductive, immune and endocrine systems, as well as being carcinogenic
- are transported in the environment over long distances to places far from the points of release.

With the evidence that POPs are transported to regions where they have never been used or produced, the international community decided in 1997 to work towards the establishment of a Convention that will serve as an international, legally binding instrument to reduce and/or eliminate releases of twelve POPs, as identified in the UNEP Governing Council Decision 19/13C. The initial list of POPs contains the nine pesticides that are listed below. The decision also includes PCBs (mainly used in electrical equipment) and two combustion by-products, dioxins and furans. The UNEP Governing Council also requested that criteria and a procedure be developed to identify further POPs as candidates for international action. This request has been complied with and more substances are therefore likely to be included in the list.

The nine pesticides in the initial list of the Stockholm Convention on POPs are: aldrin, chlordane, DDT, dieldrin, endrin, hexachlorobenzene, heptachlor, mirex and toxaphene. Along with PCBs, dioxin and furan, this original list comprised 'the dirty dozen'. None of those pesticides is currently registered by ERMA for use in New Zealand.

In May 2009 another nine chemicals (or groups of chemicals) were added to the POP list. These were (see ICS 2009):

- lindane (1)
- its by-products alpha hexachlorocyclohexane (2) and beta hexachlorocyclohexane (3)
- the flame retardants hexabromodiphenyl ether/heptabromodiphenyl ether (4), tetrabromodiphenyl ether/pentabromodiphenyl ether (5) and hexabromobiphenyl (6)
- the pesticide chlordecone (7)
- the industrial chemicals pentachlorobenzene (8) and perfluorooctane sulfonic acid, its salts, and perfluorooctane sulfonyl fluoride (9).

Datasheets have been prepared for the POPs.

## Pesticides

Pesticides with MAVs appear in Table 2.3 of the DWSNZ; some may also exert taste and odour so will appear in Table 2.5 too (aesthetic determinands). MAVs have been established for only a small fraction of the pesticides registered for use in New Zealand. The health risk of currently used pesticides that do not have a MAV, together with any new pesticides, will be reviewed for inclusion in the DWSNZ at a later date. Datasheets for pesticides with MAVs appear in Volume 3, along with a large number without a MAV, in fact all pesticides registered for use in New Zealand now have a datasheet.

Many of the early pesticides were very toxic and killed a wide range of pests and many plants or animals that were not pests. Many of them and/or their degradation products were also persistent in the environment, and some showed excessive signs of bioaccumulation. The WHO developed GVs for these, and they were adopted into the DWSNZ with MAVs. The MAVs have been retained despite the pesticide no longer being registered for use because residues are still being found, years later. Instead of having broad toxic properties, many newer pesticides target biochemical pathways specific to the type of pest being controlled; they are usually applied at lower rates, and are usually less persistent in the environment too. Datasheets have been prepared for these newer pesticides. Deriving a MAV for non-persistent pesticides is not particularly relevant because they are generally used seasonally (resulting in possible acute exposure), whereas a MAV is based on the consumption of two litres of water per day for a lifetime (chronic exposure). Acute limits are receiving international attention, and will be introduced in New Zealand in the future – see sections 10.2.5.1 and 10.2.5.4.

In the four national surveys of pesticides in groundwater and various regional monitoring programmes (MAF 2006), concentrations of individual pesticides were generally low compared with their MAVs. Pesticides exceeded the MAV in less than 1 percent of sampled wells. Six pesticides: atrazine, bromacil, cyanazine, dieldrin, MCPA and mecoprop were detected in groundwater samples in concentrations higher than their MAV, but no pesticides have been detected above their MAV in community drinking-water supplies. Dieldrin was identified at rates exceeding 50 percent of the MAV in two distribution zones that serve a total population of 360. It was also found at 33 percent of its MAV in a drinking-water supply serving 7860 people. Concentrations of four herbicides (simazine, 2,4,5-T, terbuthylazine and triclopyr) were also detected, but at rates below 5 percent of their MAV.

With respect to groundwater resources, 33 different pesticides have been detected in New Zealand aquifers. Most of the pesticides detected were herbicides; 26 different active ingredients were found. Triazines, and specifically simazine, occurred most frequently, with alachlor, bromacil and some phenoxy hormones also occurring repeatedly. The non-herbicide chemicals found most frequently were diazinon, procymidone and some organophosphates (MAF 2006). Refer to the individual datasheets for further information.

In general, groundwater contamination is more likely in shallow, unconfined aquifers with permeable soils and high groundwater recharge. This is supported by the results from Canterbury, where a high percentage of wells (87 percent) were shallow (<30 m depth), and wells where pesticides had been found were shallower than 18 m. But pesticides have also been detected in deep wells, eg, in the Pukekohe area the mobile and very persistent herbicide picloram (up to 0.0009 mg/L) has frequently been detected in a well that is 64.5 m deep and cased to 39.5 m. The vulnerability of the Edendale aquifer to groundwater contamination is related to its high recharge rate of 300–400 mm/y due to high annual rainfall coupled with a low evapotranspiration rate. The widespread use of soak holes for stormwater disposal further increases the vulnerability of this aquifer (MAF 2006).

Water suppliers drawing from catchments that have a high usage of pesticides may consider adding granular activated carbon filters to the treatment process for regular use, or storing powdered activated carbon on site for emergency use. Trials are needed to select the most effective grade of carbon. The use of activated carbon is discussed in Chapter 9: Cyanobacteria Compliance, in section 9.7.2.3 and Table 9.5; Chapter 14: Filtration Processes, in section 14.7; and in Chapter 18: Aesthetic Considerations, section 18.3 under the heading of taste and odour.

The way in which pesticides are used is prescribed in their terms of registration, which in some cases may restrict their use near bodies of water. Nevertheless, contamination of drinking-water sources may possibly occur by accident, or emergency use.

The pattern of pesticide use can be highly variable. Apart from normal seasonal change and crop use, it can depend on the weather; for example, during warm, dry weather more insecticides are used, and during humid weather more fungicides may be used. Pesticide usage depends largely on land use, or the area different crops cover. If the crop changes, the pesticides may too. Also, new products can come on to the market and become dominant, briefly, or for years. For example, azoxystrobin, a fungicide used in cereals arrived on the market in about 1997, and by 2000 in the UK was widely used on wheat. But as disease resistance started to develop and new strobilurin fungicides, such as pyraclostrobin, came to the market, its use declined. Atrazine, a herbicide used in maize was withdrawn in the UK in 2007. Immediately following its withdrawal there was an increase in use of terbuthylazine (from nothing in 2008 to 18,000 kg active substance in 2010), and a 10-fold increase in the use of mesotrione (DEFRA 2013).

## Disinfection by-products

Table 2.3 of the DWSNZ contains organic compounds of health significance (and that have a MAV) that arise from varying sources. The most frequently detected members of this group in New Zealand drinking-waters are the disinfection by-products, the type and concentration of which depend on the disinfectant used along with many other factors such as the natural organic matter content, pH, temperature and reaction time. Chapter 15: Treatment Processes, Disinfection, section 15.4 provides an outline of the factors that affect the formation of disinfection by-products. The datasheets discuss the types of by-products formed from the use of different disinfectants. Some chemicals primarily formed as disinfection by-products may also have industrial sources, not very common in New Zealand though.

Chlorination is the most extensively used disinfection process in New Zealand, indeed in the world. Information about the concentrations of some of its by-products in the country's water supplies was first obtained in the late 1980s. The predominant by-products of chlorination are trihalomethanes and haloacetic acids. In addition to chlorinated by-products, chlorine also forms by-products containing bromine when bromide is present in the water, even at quite low concentrations. This occurs as the result of chlorine oxidising bromide to bromine which is a lot more reactive. WRF (2015) discusses the use of aeration in the clearwell to reduce the concentration of volatile DBPs.

A balance needs to be found between microbiological safety and the risks posed by disinfection by-product formation. Although the microbiological quality of the water must not be sacrificed for the sake of reducing disinfection by-product formation, awareness of the factors controlling disinfection by-product formation will allow their production to be minimised while still maintaining good microbiological quality. Apart from the actual removal of natural organic matter from the raw water, the biggest single step in the reduction of DBPs has been the switch from prechlorination to postchlorination.

The disinfection by-products of ozonation are small, oxygen-rich organic molecules, such as aldehydes and ketones. Brominated compounds may arise if bromide is present in the source water.

Chlorine dioxide treatment may form halogenated by-products if there is a residual of chlorine present from the generation process.

DWI (2015) discusses disinfection by-products attributed to UV disinfection; see Chapter 15.

## General organic chemicals

The polycyclic aromatic hydrocarbons (PAHs) are now represented in Table 2.3 of the DWSNZ by only benzo[a]pyrene. These organic compounds are characteristic of the incomplete combustion of organic material. They may be present in source waters, or arise in the distribution system by being leached from coal tar-lined pipes – not common in New Zealand now.

Another major group of organic compounds in Table 2.3 with a natural source is the cyanobacterial toxins. Their appearance in water, and the organisms from which they are derived, are discussed in Chapter 9. Cyanobacteria grow as phytoplankton (free-swimming or suspended) in lakes, large rivers and domestic sewage oxidation ponds, and can also attach to river cobbles as epiphytes or benthic organisms.

The remaining compounds in Table 2.3 of the DWSNZ are, for the most part, industrial in origin. Their appearance in drinking-water water is therefore indicative of the contamination of the source water and the reason for their appearance should be investigated. New Zealand, not being particularly industrial, means many are not likely to be found in our source waters. Some however may appear as the result of water treatment processes (acrylamide), or by leaching of distribution system materials, eg, the plasticisers di(2-ethylhexyl)adipate and di(2-ethylhexyl)phthalate from plastic pipes.

Health Canada (2000) commissioned NSF International to review contaminant occurrences from treatment chemicals. Several organic substances were listed, with dimethylamine being the most persistent offender. It is an impurity in polyelectrolytes. There is no MAV in the DWSNZ for dimethylamine, but a datasheet appears in Volume 3. WHO (2004) does not have a guideline value either. Because of its frequency in drinking-water, Health Canada proposed a maximum level of 0.05 mg/L, whereas NSF proposed 0.12 mg/L.

See Ahern (2008) for a discussion on organic chemicals (including pesticides) that may be in use in New Zealand. This was updated – see Auckland City (2016); this report discusses flame retardants, plasticisers, surfactants, perfluorinated compounds, musk fragrances, pesticides, pharmaceuticals, steroid oestrogen, personal care products, preservatives, and corrosion inhibitors. These are also covered in the datasheets, in much more detail.

## 10.2.4 Health risk from toxic chemicals

Once a toxic chemical enters the body its effect is determined by the interplay of absorption, distribution, metabolism and excretion. The nature, number, severity and/or prevalence of specific effects generally increase with increasing dose, and sometimes depends on the age, sex and condition of the consumer.

Absorption of toxic chemicals across body membranes and into the bloodstream can occur in the gastro-intestinal tract, lungs and through the skin, with the gastro-intestinal tract being the main site of entry for drinking-water. Most chemicals must be absorbed once they enter the gastro-intestinal tract in order to exert their toxic effect. Following absorption, distribution of the toxicant to various organs depends on the ease with which it crosses cell membranes, its affinity for various tissues and the blood flow through the organ. In some instances, metabolism of a chemical creates a more toxic chemical than the original while in other instances it does not change, or reduces, the chemical's toxicity. Because lipid-soluble compounds are reabsorbed in the kidney and intestine due to their ability to cross cell membranes, the body metabolises these toxicants into water-soluble compounds that can be excreted easily. The major routes of excretion for chemicals from drinking-water are through the kidney and biliary system (liver) although some excretion may also occur through the lungs, gastro-intestinal tract, milk, sweat and saliva.

Local toxic effects may be produced when a material comes into contact with a body surface. Systemic effects occur when material is absorbed from a contaminated site and is disseminated by the circulatory system to cause toxic injury in various organs and tissues far from the site of primary contamination. Systemic effects may be produced by the parent material that is absorbed, or by conversion products following absorption. They may be restricted to one organ or tissue system, or affect multiple organs and tissues. Many materials may cause both local and systemic toxicity.

Health effects caused by exposure to toxic chemicals are generally classified in the following categories: organ-specific; neurological/behavioural; reproductive/developmental/teratological; carcinogenic/mutagenic. Effects may be prolonged or short-term, reversible or irreversible, immediate or delayed, single or multiple.

Toxic chemicals fall into two categories:

- all non-carcinogenic compounds and a number of carcinogenic compounds where the effects are observed only above a certain threshold dose with no effects observed below this threshold
- genotoxic carcinogens that do not appear to have a threshold for toxic effects to occur.

A different approach is used for the derivation of the MAV depending on the category in which the chemical is placed.

The International Agency for Research on Cancer (IARC) has classified a large number of compounds according to their carcinogenicity to humans. WHO has evaluated each compound that has been shown to be a carcinogen on a case-by-case basis and the reasoning behind their classification and derivation of the MAV for the carcinogens is given in section 10.2.5.2.

MAF (2006) states that WHO has yet to resolve how to deal with the impact of mixtures of pesticides in drinking-water on human health (see section 10.2.5.3 for developments). Groundwater surveys in New Zealand have revealed that most contamination occurs as mixtures, such as a range of triazine herbicides, whereas most toxicity and exposure assessments are based on controlled experiments with only one contaminant. The European Commission (EC) produced a non-specific guideline for pesticides in drinking water of 0.0001 mg/L per pesticide and 0.0005 mg/L for the total of pesticide residues in a sample (EC Directive 80/778, 1980), but the standard for total pesticides was not based on toxicological studies.

Another uncertainty is that most water monitoring programmes do not include pesticide degradation products, some of which are equally toxic or even more toxic and also more polar, thus more mobile than the corresponding parent compounds. However, there are generally no established standards for metabolites, even though metabolites may have similar effects to their parent compounds (MAF 2006).

MAF (2006) added that an emerging concern is the interference of some chemicals with endocrine systems. Some of the most frequently detected pesticides (simazine and atrazine) are suspected endocrine disrupters. At present this issue is controversial. This, and the matters mentioned above, will probably be addressed by the WHO, and therefore the DWSNZ, in the future.

The World Health Organization keeps up to date with emerging issues, publishing peer-reviewed reports which are available from the internet; the topic of pharmaceuticals in drinking water is a recent example (WHO 2011a). An important observation was that raw sewage and wastewater effluents are a major source of pharmaceuticals found in surface waters. Keep up to date on emerging issues by looking at [www.who.int/water\\_sanitation\\_health](http://www.who.int/water_sanitation_health)

WRF (2015a) reviewed the literature associating bladder cancer with chlorination disinfection by-products.

## 10.2.5 Derivation of MAVs for chemicals of health significance

The MAVs for most of the chemical determinands included in the DWSNZ have been adapted from the assessments of the toxicity of drinking-water contaminants published in the *Guidelines for Drinking-Water Quality* (WHO 2004a) and subsequent rolling revisions, see section 1.6.2 of these Guidelines. The information in the sections describing the derivation of the MAVs (sections 10.2.5.1 and 10.2.5.2) has been taken from this source. WHO has used published reports from the open peer reviewed literature, information submitted by governments and other parties, and unpublished proprietary data to develop the guidelines. WHO has used expert judgement to select the most suitable experimental animal study on which to base the extrapolation and the derivation of each of their guideline values.

Toxicity testing identifies toxicants by their biological activity and/or their effect on biological systems. Toxicity can be tested at the cellular level with *in vitro* bioassays, and in whole organisms with *in vivo* bioassays. If testing demonstrates that toxicity is possible, an epidemiological study of the exposed population may be warranted to check whether the contaminant has resulted in human health effects. Although epidemiology is a more relevant measure of human health than *in vitro* and *in vivo* testing, designing and conducting these types of studies for detecting the effect of drinking-water on human health can be both challenging and time-consuming.

A fundamental principle of toxicology is that, for a chemical administered to a genetically homogeneous population of animals from the same species, the proportion exhibiting a particular toxic effect will increase as the dose increases. For many toxic effects, except genotoxic carcinogens, there is a dose below which no effect or response can be elicited, referred to as the 'threshold dose'. The threshold concept, a corollary of the dose-response relationship, is important. It implies that it is possible to determine a 'no observed effect level' (NOEL), which can be used as the basis for assigning 'safe levels' for exposure.

The basis of the derivation of the MAVs is information on the health effects resulting from exposure to the chemicals. Such information comes from studies on human populations or on laboratory animals. Toxicity studies using animals are most commonly used but their value is generally limited due to the relatively small number of animals used, the relatively high doses administered and the need to extrapolate the results of these studies to human populations subject to low doses. Epidemiological studies, studies of health effects following exposure to chemicals on human populations, are available less often and are sometimes of reduced value because of the lack of quantitative information on the concentrations to which the people have been exposed or to what else the populations have been simultaneously exposed.



### 10.2.5.1 Derivation of MAVs based on a tolerable daily intake approach

For most kinds of toxicity, it is generally believed that there is a dose below which no adverse effects will occur. The MAVs for the determinands that are non-carcinogenic or non-genotoxic carcinogens have been calculated on the basis of a tolerable daily intake (TDI) approach. This is also called an acceptable daily intake (ADI).

The overall process for deriving the MAVs is presented in the following sections. Information has been assessed to select the most suitable study to use as the basis for choosing a NOAEL (no observed adverse effects level) or, if that is not available, a LOAEL (lowest observable adverse effect level). Sometimes the literature refers to the NOEL (no observed effects level). This value is divided by an uncertainty factor (UF) reflecting the level of uncertainty associated with the NOAEL or LOAEL to determine a tolerable daily intake (TDI). The MAV is determined by multiplying this value by the average weight of a person (BW) and by the proportion (P) of the TDI that a person is likely to ingest in drinking-water, and by dividing by the average volume of water that a person will drink during one day (C). Definitions appear at the end of section 10.2.5.1.

$$\text{TDI} = \frac{\text{NOAEL (LOAEL)}}{\text{UF}} \text{ and } \text{MAV} = \frac{\text{TDI} \times \text{BW} \times \text{P}}{\text{C}}$$

In the individual datasheets the derivation of the MAV of each chemical which has been based on a TDI approach is shown as a combination of the above two equations as shown below:

$$\text{MAV} = \frac{\text{NOAEL/LOAEL} \times \text{BW} \times \text{P}}{\text{UF} \times \text{C}}$$

where:

|          |  |
|----------|--|
| TDI/ADI: | tolerable/acceptable daily intake (mg/kg body weight/day)  |
| NOAEL:   | no observable adverse effect level   |
| LOAEL:   | lowest observable adverse effect level   |
| MAV:     | Maximum Acceptable Value in mg/L   |
| BW:      | body weight (70 kg for adult; 10 kg for two-year old children; 10 kg calculation is used for infants for DDT + isomers and 5 kg is used for lead and short-term nitrite) |
| P:       | proportion of tolerable daily intake attributable to drinking-water  |
| C:       | the average volume of water consumed per day (adults two litres; children one litre; infant 0.75 litre)  |
| UF:      | uncertainty factor   |

In general MAVs calculated by the above equation have been rounded to one significant figure using the following rules:

- if the second and third significant figures were between 01 and 50 inclusive the MAV was rounded down
- if the second and third significant figures were >50 the MAV was rounded up.



## Calculation of MAVs

For non-carcinogenic and non-genotoxic carcinogens, the TDI approach is used to calculate the MAVs. TDIs are regarded as representing a tolerable intake for a lifetime. In summary, this involves:

- 1 a no observed adverse effects level (NOAEL) or lowest observed adverse effects level (LOAEL) is obtained from animal or human studies
- 2 the uncertainty factor (UF) associated with the NOAEL or LOAEL is selected. Most lie between 100–1000
- 3 the TDI equals the NOAEL (or LOAEL) divided by the UF, the units being mg per kg of body weight per day
- 4 the MAV equals the TDI times body weight times the proportion of the TDI that comes from drinking water, divided by the volume drunk.

There are exceptions to this approach, such as nitrate. The primary health concern regarding nitrate and nitrite is the formation of methaemoglobinaemia, so-called blue-baby syndrome. The derivation is based on epidemiological studies, methaemoglobinaemia was not reported in infants in areas where drinking-water consistently contained less than 50 mg of nitrate per litre; see datasheet for further information. Nitrate is reduced to nitrite in the stomach of infants, and nitrite is able to oxidise haemoglobin (Hb) to methaemoglobin (metHb), which is unable to transport oxygen around the body. WHO (2004a) concluded that extensive epidemiological data support the current guideline value for nitrate-nitrogen of 10 mg/litre, but stated that this value should be expressed not on the basis of nitrate-nitrogen but on the basis of nitrate itself, which is the chemical entity of concern to health.

The calculations showing the derivation of the MAVs are included on the datasheets.

## Definition of terms

### Toxicity studies

Acute toxicity studies evaluate single-dose effects. Sub-chronic toxicity studies evaluate short-term, repeat-dose effects. Chronic toxicity studies evaluate long-term, repeat-dose effects, often covering the lifespan of the test animal. Reproductive toxicity studies are designed to provide general information about the effects of a test substance on reproductive performance in both male and female animals (this includes teratogenicity studies which cover the adverse effects on the developing embryo and foetus). Developmental toxicity studies examine the spectrum of possible in-utero outcomes. Genotoxicity studies are designed to determine whether test chemicals can perturb genetic material to cause gene or chromosome mutations. Carcinogenic studies observe test animals for a major portion of their lifespan for neoplastic lesions during or after exposure to various doses of a test substance by an appropriate route.

### Tolerable daily intake

The TDI is an estimate of the amount of a substance in food and drinking-water, expressed on a body weight basis (mg/kg or mg/kg of body weight) that can be ingested on a daily basis over a lifetime without appreciable health risk, that is, TDI is an assessment of chronic effects. The TDI is based on the lowest NOAEL obtained in studies on the most sensitive species.

As TDIs are regarded as representing a tolerable intake for a lifetime, they are not so precise that they cannot be exceeded for short periods of time. A short-term exposure to levels exceeding the TDI (within reason) is not a cause for concern provided the individual's intake averaged over longer periods of time does not appreciably exceed the level set. The large uncertainty factors generally involved in establishing a TDI serve to provide assurance that exposure exceeding the TDI for short periods is unlikely to have any deleterious effects upon health. However, consideration should be given to any acute toxic effects that may occur if the TDI is substantially exceeded for short periods of time. See section 10.2.5.4 for a discussion on short-term exposure limits.

ADI refers to the acceptable daily intake and means the same as TDI.

### Chronic reference dose (cRfD)

The USEPA defines chronic reference dose (cRfD or sometimes just RfD) as 'an estimate, with uncertainty spanning perhaps an order of magnitude, of a daily oral exposure to the human population (including sensitive subgroups) that is likely to be without an appreciable risk of deleterious effects (other than cancer) during a lifetime'. If the value is adjusted due to a sensitive sector of the population, it is called population adjusted dose (PAD). This chronic reference dose would appear to be the same as tolerable/acceptable daily intake (TDI/ADI).

### Acute reference dose (ARfD)

The acute reference dose or ARfD (an expression used by the USEPA and more recently the WHO) is the maximum quantity of an agricultural or other chemical that can safely be consumed as a single, isolated, event.<sup>2</sup> The ARfD is derived from the lowest single or short-term dose which causes no effect in the most sensitive species of experimental animal tested, together with a safety factor which reflects the quality of the toxicological database and takes into account the variability in responses between species and individuals.

### Drinking water equivalent level (DWEL)

The USEPA also uses the concept of drinking water equivalent level or DWEL, which is defined as 'a lifetime exposure concentration protective of adverse, non-cancer health effects that assumes all of the exposure to a contaminant is from the drinking water'.

<sup>2</sup> Note some definitions use 'a day' instead of 'single event'. See section 10.2.5.4 for further discussion.

## Human Health Benchmarks for Pesticides (HHBPs)

The USEPA (in 2012) developed the concept of Human Health Benchmarks for Pesticides (HHBPs); acute or one-day HHBPs, chronic or lifetime (non-cancer) HHBPs, and carcinogenic HHBPs. HHBPs are the concentrations in water at or below which adverse health effects are not anticipated from one-day or lifetime exposures. Chronic HHBPs are similar to our MAVs. Acute or one-day HHBPs are in essence, short-term MAVs. See <http://iaspub.epa.gov/apex/pesticides/f?p=HHBP:home> and <http://www.epa.gov/sites/production/files/2015-10/documents/hh-benchmarks-techdoc.pdf>

## Minimal risk levels (MRLs)

The US Department of Health and Human Services, Agency for Toxic Substances & Disease Registry (ATSDR: latest Oct 2015) has developed minimal risk levels (MRLs) which are similar to the USEPA's reference dose (RfD), ie, an estimate of the daily human exposure to a hazardous substance that is likely to be without appreciable risk of adverse non-cancer health effects over a specified duration of exposure. ATSDR uses the no observed adverse effect level/uncertainty factor (NOAEL/UF) approach to derive MRLs for hazardous substances. They are set below levels that, based on current information, might cause adverse health effects in the people most sensitive to such substance induced effects. MRLs are derived for acute (1 to 14 days), intermediate (15 to 364 days), and chronic (365 days and longer) exposure durations, and for the oral and inhalation routes of exposure.

## No observed adverse effect level (NOAEL) and lowest observed adverse effect level (LOAEL)

The NOAEL is defined as the highest dose level or concentration of a chemical in a single study, found by experiment or observation, which causes no detectable adverse health effect. If a NOAEL is not available, a LOAEL may be used to derive the MAV. The LOAEL is the lowest dose or concentration of a chemical in a single study, found by experiment or observation that causes a detectable adverse health effect.

Some studies record the largest dose at which no effects are observed is identified. This dose level is called the 'No observable effect level', or NOEL.

## Uncertainty factors

Uncertainty factors are used to correct both the NOAEL and LOAEL for the uncertainties intrinsic to extrapolation between animal studies and human populations or from a small human group to the general population. In the derivation of their drinking-water guidelines, WHO has applied uncertainty factors to the NOAEL or LOAEL selected using the approach outlined below:

| Source of uncertainty                          | Factor |
|--|--------|
| Interspecies variation (animals to human)      | 1–10   |
| Intraspecies variation (individual variations) | 1–10   |
| Adequacy of studies or database                | 10     |
| Nature and severity of effect                  | 1–10   |

The datasheets for the chemical contaminants explain the reason for the selection of the uncertainty factor for each compound. The method of computation of MAVs from NOAELs and LOAELs has to allow for a number of uncertainties, including:

- the animal species on which the study was based may be less sensitive than humans
- some humans are more sensitive than others
- some animals within the species used to derive the toxicity data may be more sensitive to the effects of a chemical than the particular animals used for the tests.

If adverse effects are observed at all dose levels tested, an additional uncertainty factor is usually applied, because the NOAEL, by definition, would be lower than the LOAEL, had it been observed.

Situations where the nature and severity of effect might warrant an additional uncertainty factor include studies where the end-point was malformation of a foetus or where the end-point determining the NOAEL was directly related to possible carcinogenicity.

The uncertainty factor is determined by multiplying together the factors from each of the four sources. Typically, uncertainty factors lie between 100 and 1000. Uncertainty factors do not exceed 10,000 because the MAV would cease to have meaning as a health-effect value.

#### Human body weight

To calculate the MAVs it has been assumed that the average weight of a New Zealand adult is 70 kg. This is also the figure used in the *Australian Drinking-Water Guidelines* (NHMRC 2004/2011). WHO (2004a) has calculated its guideline values using an adult weight of 60 kg due to the lower adult weights commonly found in developing countries. As mentioned earlier, some MAVs are based on the effects on children, where a body weight of 10 kg has been used.

#### Proportion of intake from drinking-water

The intake of the compounds covered in the drinking-water standards can occur from food, air, skin absorption, pharmaceuticals and other products, as well as from drinking-water. Therefore it is necessary to determine what proportion of the total human intake is likely to occur as a result of consuming water.

Wherever possible, WHO used data concerning the proportion of total intake normally ingested in drinking-water (based on mean levels in food, air and drinking-water) or intakes estimated on the basis of consideration of physical and chemical properties were used in the derivation of the WHO guideline values. Where such information was not available, an arbitrary (default) value of 10 percent for drinking-water was used. This default value is, in most cases, sufficient to account for additional routes of intake (ie, inhalation and dermal absorption) of contaminants in water.

### Volume of drinking-water consumed

An assumed water intake of two litres per day for adults is commonly used by WHO and regulators in computing drinking-water guidelines and standards. WHO (2003) reviewed water consumption and hydration needs under a variety of conditions, retaining the two litres per day. Physical exertion, especially in extreme heat, can significantly increase water requirements. Sweat rates can reach 3–4 L/h, with variations in rate depending upon work/exercise intensity and duration, age, sex, lactation/pregnancy, training and conditioning, heat acclimatisation, air temperature, humidity, wind velocity, cloud cover and, clothing. The 2 L/d consumption rate is considered appropriate for New Zealand conditions.

Recent material from Australia discusses many of the above points: *Environmental Health Risk Assessment: Guidelines for assessing human health risks from environmental hazards (EnHealth 2012 update)*.

[http://www.health.gov.au/internet/main/publishing.nsf/content/804F8795BABFB1C7CA256F1900045479/\\$File/DoHA-EHRA-120910.pdf](http://www.health.gov.au/internet/main/publishing.nsf/content/804F8795BABFB1C7CA256F1900045479/$File/DoHA-EHRA-120910.pdf)

### 10.2.5.2 Derivation of MAVs for potentially carcinogenic compounds

The International Agency for Research on Cancer (IARC) has evaluated available evidence to classify chemical substances with respect to their potential carcinogenic risk to humans into the following groups:

- Group 1: the agent is carcinogenic to humans
- Group 2A: the agent is probably carcinogenic to humans
- Group 2B: the agent is possibly carcinogenic to humans
- Group 3: the agent is not classifiable as to its carcinogenicity to humans
- Group 4: the agent is probably not carcinogenic to humans.

The International Agency for Research on Cancer (IARC) is part of the World Health Organization. IARC's mission is to coordinate and conduct research on the causes of human cancer, the mechanisms of carcinogenesis, and to develop scientific strategies for cancer prevention and control. The Agency is involved in both epidemiological and laboratory research and disseminates scientific information through publications, meetings, courses, and fellowships.

A more detailed description of these classifications is presented in the IARC classification near the end of this subsection, and any other available information was taken into consideration in establishing the WHO drinking-water guidelines.

It is generally considered that the initiating event in the process of chemical carcinogenesis is the mutation in the genetic material (DNA) of somatic cells (ie, cells other than ova and sperm). Because the genotoxic mechanism theoretically does not have a threshold, there is a probability of harm at any level of exposure. Therefore the use of a threshold approach (see section 10.2.5) is considered inappropriate and mathematical low-dose risk extrapolation has been used. Non-threshold models assume linearity between the lowest experimentally derived dose and the zero dose.

This implies that there is a calculable probability of an adverse effect (risk) no matter how small the dose.

However, there are carcinogens that are capable of producing tumours in animals or humans without exerting genotoxic activity, but acting through an indirect mechanism. It is generally believed that a threshold dose exists for these non-genotoxic carcinogens.

Each compound that has been shown to be a carcinogen has been evaluated on a case-by-case basis, taking into account the evidence of genotoxicity, the range of species affected, and the relevance to humans of the tumours observed in experimental animals. For carcinogens for which there is convincing evidence to suggest a non-genotoxic mechanism, MAVs were calculated using the threshold approach explained in section 10.2.5.1 for the non-carcinogens.

WHO determined the guidelines for genotoxic carcinogens generally using the linearised multistage model. This model extrapolates the dose-response relationship observed at higher doses to the risk that may be associated with lower concentrations.

#### The IARC Classification of the Carcinogenicity of Compounds (ex IARC Monograph No. 54)

|  |   |
|--|---|
| <b>Group 1:</b> The agent (mixture) is carcinogenic to humans. The exposure circumstance entails exposures that are carcinogenic to humans.                    | This category is used when there is <i>sufficient evidence</i> of carcinogenicity in humans. Exceptionally, an agent (mixture) may be placed in this category when evidence in humans is less than sufficient but there is <i>sufficient evidence</i> of carcinogenicity in experimental animals and strong evidence in exposed humans that the agent (mixture) acts through a relevant mechanism of carcinogenicity.   |
| <b>Group 2</b>   | This category includes agents, mixtures and exposure circumstances for which, at one extreme, the degree of carcinogenicity in humans is almost sufficient, as well as those for which, at the other extreme, there are no human data but for which there is evidence of carcinogenicity in experimental animals. Agents, mixtures, and exposure circumstances are assigned to either group 2A (probably carcinogenic to humans) or group 2B (possibly carcinogenic to humans) on the basis of epidemiological and experimental evidence of carcinogenicity and other relevant data.  |
| <b>Group 2A:</b> The agent (mixture) is probably carcinogenic to humans. The exposure circumstance entails exposures that are probably carcinogenic to humans. | This category is used when there is <i>limited evidence</i> of carcinogenicity in humans and <i>sufficient evidence</i> of carcinogenicity in experimental animals. In some cases, an agent (mixture) may be classified in this category when there is <i>inadequate evidence</i> of carcinogenicity in humans and <i>sufficient evidence</i> of carcinogenicity in experimental animals and strong evidence that the carcinogenesis is mediated by a mechanism that also operates in humans. Exceptionally, an agent, mixture, or exposure circumstance may be classified in this category solely on the basis of <i>limited evidence</i> of carcinogenicity in humans.  |
| <b>Group 2B:</b> The agent (mixture) is possibly carcinogenic to humans. The exposure circumstance entails exposures that are possibly carcinogenic to humans. | This category is used for agents, mixtures and exposure circumstances for which there is <i>limited evidence</i> of carcinogenicity in humans and less than <i>sufficient evidence</i> of carcinogenicity in experimental animals. It may also be used when there is <i>inadequate evidence</i> of carcinogenicity in humans but there is <i>sufficient evidence</i> of carcinogenicity in experimental animals. In some instances, an agent, mixture or exposure circumstance for which there is <i>inadequate evidence</i> of carcinogenicity in humans, but <i>limited evidence</i> of carcinogenicity in experimental animals together with supporting evidence from other relevant data may be placed in this group. |

#### The IARC Classification of the Carcinogenicity of Compounds (ex IARC Monograph No. 54)

|   |  |
|---|--|
| <b>Group 3:</b> The agent (mixture or exposure circumstance) is not classifiable as to its carcinogenicity to humans. | This category is used most commonly for agents, mixtures, and exposure circumstances for which the evidence of carcinogenicity is inadequate in humans and inadequate or limited in experimental animals.<br>Exceptionally, agents (mixtures) for which the evidence of carcinogenicity is inadequate in humans but sufficient in experimental animals may be placed in this category when there is strong evidence that the mechanism of carcinogenicity in experimental animals does not operate in humans.<br>Agents, mixtures and exposure circumstances that do not fall into any other group are also placed in this category. |
| <b>Group 4:</b> The agent (mixture) is probably not carcinogenic to humans.   | This category is used for agents or mixtures for which there is <i>evidence suggesting lack of carcinogenicity</i> in humans and in experimental animals. In some instances, agents or mixtures for which there is <i>inadequate evidence</i> of carcinogenicity in humans but <i>evidence suggesting lack of carcinogenicity</i> in experimental animals, consistently and strongly supported by a broad range of other relevant data, may be classified in this group.   |

A number of uncertainties are involved in this type of derivation. The models used are conservative and tend to overestimate rather than underestimate the risk, thus providing a greater degree of protection. The MAVs selected for most genotoxic carcinogens are associated with an estimated excess lifetime cancer risk of  $10^{-5}$ . This means there is a risk of one additional cancer per 100,000 people ingesting drinking-water containing the substance at the same concentration as the MAV for 70 years. Concentrations associated with estimated excess lifetime cancer risks of  $10^{-4}$  and  $10^{-6}$  can be calculated by multiplying and dividing, respectively, the MAV by 10.

### 10.2.5.3 Exposure to more than one chemical

Policy and risk management processes are primarily focused on the safety of individual chemicals. However, the general population is exposed to a wide range and number of chemicals in all media and there is growing concern around recognition of the potential for a combined adverse effect when chemicals occur together. Assessing the combined risks to human health from exposure to chemical mixtures is much more complex than for single entities. The main challenges faced by regulators are how to determine the degree to which humans are co-exposed to chemicals, what interactions may occur among these, and what specific human health impacts are associated with the chemical mixtures.

There are no generally accepted procedures for estimating the risk arising for simultaneous exposure to more than one chemical.

Groups of chemicals that may exert an additive common effect include the:

- triazine pesticides and their metabolites: atrazine, cyanazine, propazine, simazine and terbutylazine
- N-methyl carbamates pesticides: aldicarb, bendiocarb, carbaryl, carbofuran, formetanate, methiocarb, methomyl, oxamyl, pirimicarb and propoxur
- large chemical groups such as the dioxins, PCBs, PAHs, groups of pharmaceuticals, chlorinated aromatics, microcystins, perfluorinated chemicals, and VOCs
- groups of disinfection by-products that have a similar composition or toxic effects, such as the THMs, HAAs and HANs.

WHO (2017a) discusses these issues and includes case studies for pharmaceuticals, microcystins, oestrogens, and N-methyl carbamates. These are discussed further in the datasheets.

For trihalomethanes (THMs), the WHO (Guidelines 2011) has used the approach of summing the ratios of the concentration of each determinand to its respective MAV. The THMs are bromodichloromethane, bromoform, chloroform and dibromochloromethane. If the sum of the ratios exceeds 1.0 the MAV for THMs has been exceeded. See example calculation in the trihalomethane datasheet.

This approach is generalised in section 8.2.1 of the DWSNZ to cover other groups of substances with similar health effects. Families of disinfection by-products, such as the haloacetic acids (HAAs) and haloacetonitriles (HANs) should be handled in this manner. In using this approach no individual determinand may have exceeded its MAV, but the group together may exceed the MAV of one. WHO (2011) states that the sum of the ratio approach should also be used for nitrate and nitrite; however, in reality, the concentration of nitrite in New Zealand waters is usually so low that it has little effect in the outcome.

The approach of summing the ratios only applies to those determinands with a MAV. That is despite only three of the nine potential haloacetic acids having a MAV and only two of the 10 potential haloacetonitriles having a MAV.

When a determinand is reported to be less than its limit of detection (LoD), a value equal to half the LoD should be used in the calculation. This pragmatic solution takes into account both practical and statistical considerations rather than being 'scientifically defensible'. There are three main options in doing the calculation when <LoDs (non-detects) have been reported:

- a) replacing less than LoD values with zero
- b) replacing less than LoD values with the LoD
- c) replacing less than LoD values with a figure  $>0$  and  $<LOD$ .

Option a) reduces the risk of false positives and gives the water supplier the benefit of doubt

Option b) reduces the risk of false negatives and gives the consumer the benefit of doubt, and

Option c) choosing a value equal to half the LoD is a compromise between the two.

This is discussed further in the Appendix in Chapter 1 where it states that case a) above is appropriate if there are not a lot of "less thans". There is basically no solution if "less than values" predominate. A solution is offered for the intermediate situation.

Choosing a laboratory or analytical procedure with the lowest LoD will reduce the chance of these determinands becoming a P2.



#### 10.2.5.4 Short-term exposure values (STEVs)

See section 10.2.5.1 for some definitions.

The WHO *Guidelines* (WHO 2017) discuss health-based values for use in emergencies. Section 8.7.5 includes:

Health-based values for acute and short-term exposures (called acute and short-term health-based values) can be derived for any chemicals that are used in significant quantities and are involved in an emergency, such as a spill into surface water sources. JMPR has provided guidance on the setting of acute reference doses (ARfDs) for pesticides (Solecki et al 2005). These ARfDs can be used as a basis for deriving acute health-based values for pesticides in drinking-water, and the general guidance can also be applied to derive ARfDs for other chemicals. The JMPR ARfD is usually established to cover the whole population, and must be adequate to protect the embryo or foetus from possible in utero effects. An ARfD based on developmental (embryo/foetal) effects, which applies to women of childbearing age only, may be conservative and not relevant to other population subgroups.

The ARfD can be defined as the amount of a chemical, normally expressed on a body weight basis that can be ingested in a period of 24 hours or less without appreciable health risk to the consumer. Most of the scientific concepts applicable to the setting of ADIs or TDIs for chronic exposure apply equally to the setting of ARfDs. The toxicological end-points most relevant for a single or one-day exposure should be selected. For ARfDs for pesticides, possible relevant end-points include haematotoxicity (including methaemoglobin formation), immunotoxicity, acute neurotoxicity, liver and kidney toxicity (observed in single-dose studies or early in repeated-dose studies), endocrine effects and developmental effects. The most relevant or adequate study in which these end-points have been determined (in the most sensitive species or most vulnerable subgroup) is selected, and NOAELs are established. The most relevant end-point providing the lowest NOAEL is then used in the derivation of the ARfD. Uncertainty factors are used to extrapolate from experimental animal data to the average human and to allow for variation in sensitivity within the human population. An ARfD derived in such a manner can then be used to establish an acute health-based value by allocating 100 percent of the ARfD to drinking-water, as follows:

$$\text{acute health-based value} = \text{ARfD} \times \text{Rfbw} \times \text{D} \times \text{C}$$

where:

bw = body weight (60 kg for adult, 10 kg for children, 5 kg for infants)

P = fraction of the ARfD allocated to drinking-water (100%)

C = daily drinking-water consumption (2 L for adults, 1 L for children, 0.75 L for bottle-fed infants).

[For the common situation in New Zealand, ie, for a 70 kg adult, the STEV is ARfD x 35.]

However, available data sets do not allow the accurate evaluation of the acute toxicity for a number of compounds of interest. If appropriate single-dose or short-term data are lacking, an end-point from a repeated-dose toxicity study can be used. This is likely to be a more conservative approach, and this should be clearly stated in the health-based value derivation. When a substance has been spilt into a drinking-water source, contamination may be present for a period longer than 24 hours, but is not usually present for longer than a few days. Under these circumstances, the use of data from repeated-dose toxicity studies is appropriate to derive a short-term health-based value (using the approach outlined in section 8.2.2). As the period of exposure used in these studies will often be much longer than a few days, this, too, is likely to be a conservative approach.

Where there is a need for a rapid response, and suitable data are not available to establish an ARfD but a guideline value or health-based value is available for the chemical of concern, a pragmatic approach would be to allocate a higher proportion of the ADI or TDI to drinking-water. As the ADI or TDI is intended to be protective of lifetime exposure, small exceedances of the ADI or TDI for short periods will not be of significant concern for health. In these circumstances, it would be reasonable to allow 100 percent of the ADI or TDI to come from drinking-water for a short period.

#### 10.2.5.5 Preparation of and response to short-term exposures

Water suppliers need to address the risks of short-term exposures in their WSPs (see Chapter 2 Management of Community Supplies, section 2.2.2 Risk health risk management plans) and contingency plans (see section 2.2.3 Contingency planning). Short-term exposure values (STEVs) and/or ARfDs are included in most of the chemical datasheets.

A chemical spill or accidental discharge may lead to MAVs or short-term limits being exceeded. Section 3.1.2 of the DWSNZ discusses major transgressions, and includes the following paragraph:

Major transgressions are serious. The water supplier must carry out the actions specified in the DWSNZ immediately, which includes informing the DWA so the DWA can help to identify the steps needed to protect consumers. In the case of a major transgression, a medical officer of health may issue a water supplier with a compliance order to take appropriate action to protect public health under section 69ZZH of the Act.

The following general checklist may assist in assessing the degree and duration of risk following a spill of a chemical determinand of health significance. The WSP needs to address the following issues if spills or accidental discharges can affect raw water.

##### a) The risk

- What chemicals are stored, used, discharged or transported in the catchment?
- Are the users aware of the risk caused by the chemical(s); have alternatives been considered?
- Do those responsible have adequate controls in place to minimise the risks?

- Are procedures in place for water suppliers being advised of incidents?
- Is the local HazMat Coordination Committee active?

#### b) The spill

- What was spilt, and where (bankside point discharge or other)?
- If to land, is groundwater also at risk?
- What volume and concentration was spilt, when, and at what rate did it discharge?
- If more than one chemical involved, are effects additive? See section 10.2.5.3.
- Does the water supplier and regional council have an appropriate contingency plan in place?

#### c) The source water

- Is it a lake/reservoir, stream/river, roof or groundwater source?
- Are there any tributaries between the spill and the intake?
- What are the current flow and dispersion characteristics of the source water?
- How long will the spill take to reach the intake and how long will it take to pass?
- What is the water temperature, pH, turbidity?

#### d) The chemical(s)

- Is it a single substance, or a mixture?
- Does the chemical have a MAV, STEV, or other health advisory such as TDI (ADI)?
- Or is it likely to give rise to taste/odour complaints?
- What is its water solubility, or does it volatilise, sink or float?
- Is it likely to adhere to particles (its  $K_{ow}$ ) and is it mobile in soils?
- What are its evaporation, hydrolysis, photolysis rates in the source water?
- What are its biological uptake rates and bacterial degradation rates?
- What degradation products are formed and are they toxic?
- Which laboratories can analyse the chemicals concerned?
- How long does it take to obtain a result?

#### e) The treatment process

- Can the substance be prevented from entering the intake, eg, with booms or absorbents?
- Can abstraction be stopped until the chemical has passed the intake?
- Can a different abstraction point or off-river storage be used?
- How much of the chemical will be removed by the standard treatment process?
- Will it interfere with the treatment process or react with WTP chemicals?
- Can the treatment process be modified in time, eg, is activated carbon available?
- Can contaminated stored water be run to waste?

#### f) The distribution system

- What is the estimated concentration of the substances concerned?
- How long will it remain in the distribution system?
- What measures can be taken if the concentration or duration is excessive?

#### g) Need for a desk study

- Until the chemicals have been identified, assume a worst case.
- Raw and final water concentrations will vary so testing samples may not be practicable.
- Test results may not be available for a few days.
- Is a STEV or other health advisory available, or can one be calculated quickly?
- An idea of likely concentrations can be estimated by taking into account items in a) to f).

## 10.2.6 Plumbosolvent water

Health-significant metals, usually heavy metals, often appear in drinking-water. From 1995 to 2000, the Priority 2 Chemical Determinands Identification Programme assessed 859 distribution zones, 393 (46 percent) of which were found to contain at least one heavy metal (antimony, cadmium, copper, lead or nickel) at a concentration in excess of its MAV in the first flush of water taken from the sampling point (Nokes and Davies 2000). The metals most frequently detected were lead and nickel.

These metals are rarely present in New Zealand source waters; it is much more common for them to appear in the water as the result of dissolution of materials within the reticulation network, or from the plumbing materials used in consumers' premises. Control of metal concentrations in the water supplied to the consumers' premises is the responsibility of the water supplier, either through source water selection, the use of suitable treatment processes or changes to the materials used in the reticulation network. Metals found to be present in the *reticulated* water at potentially health-significant concentrations (greater than 50 percent of their MAV) are therefore assigned as Priority 2b determinands to the supply concerned.

Materials from which plumbing fittings are made also influence the concentrations of metals present in drinking water. This source of metals (from fittings already installed) is outside the water supplier's direct control, and heavy metal Priority 2b determinands are not assigned to supplies when the source of the metal in a tap sample is the consumer's plumbing. Instead, the water is designated as plumbosolvent, Priority 2c. Although the term plumbosolvent refers to lead, plumbosolvent waters are also likely to cause the release of other metals from plumbing materials. Elevated concentrations of metals of health concern caused by poor grade domestic plumbing, fittings or faulty installation are not covered in the DWSNZ.

Waters designated as plumbosolvent do not have to be monitored for heavy metals. However, to reduce the intake of heavy metals by consumers, the DWSNZ require consumers receiving plumbosolvent water to be advised to flush taps briefly before water is drawn for drinking or food preparation purposes (see DWSNZ section 8.2.1.4).

New Zealand's source waters are generally softer, and have lower dissolved solids content than is typical of many overseas waters. These characteristics are often associated with waters having slightly acidic pH levels and moderate to low alkalinities, and give rise to plumbosolvent drinking-waters being widespread in New Zealand. Many untreated bore waters contain carbon dioxide, which also causes corrosion of metallic pipes and fittings. Removal of the carbon dioxide is relatively straightforward and is not a particularly expensive treatment process (see Chapter 12) and should be considered as an appropriate remedial action in supplies where it causes corrosion of consumers' plumbing. Also, drinking-waters prepared by deionisation, distillation and reverse osmosis contain very few minerals so readily dissolve or corrode chemicals from water supply fittings.

Many factors influence the concentration of heavy metals found in a water sample. As well as the materials in contact with the water and the water's chemistry and temperature, other factors include: sample volume; surface area to volume ratio; water scour rate (velocity); standing time of water in the plumbing; and previous use of the sampling point. The combined effects of these factors can result in highly variable metal concentrations being found in a distribution zone. Limited sampling in a distribution zone may not, therefore, find evidence of corrosion despite a water being plumbosolvent.

To avoid plumbosolvent waters being overlooked, and because of the nature of source waters in New Zealand, the assumption is made in the DWSNZ that all drinking-waters are plumbosolvent, in which case, water suppliers are to follow the requirements in section 8.2.1.4 of the DWSNZ. Section 8.3.5(b) of the DWSNZ offers the option of demonstrating that the water supply is not plumbosolvent, and the procedure for this is specified in section 10.3.3 of the Guidelines.

Section 8.2.1.4 of the DWSNZ requires water suppliers servicing more than 500 people to issue a notice every six months. The notice could be a public notice in the local newspapers. A notice should also be included with the rate demand or water invoice, in which case it is recommended that landlords pass the information on to their tenants. A suggested format was sent to water suppliers on 12 December 2006, signed by the Director-General of Health. It said:

Some plumbing fittings have the potential to allow minute traces of metals to accumulate in water standing in the fittings for several hours.

Although the health risk is small, the Ministry of Health recommends that you flush a mugful of water from your drinking-water tap each morning before use to remove any metals that may have dissolved from the plumbing fittings.

We are recommending this simple precaution for all households, including those on public and private water supplies.

In 2014, the Ministry of Health stated that reference to the Director-General of Health should no longer be used on these notices as water suppliers should be taking ownership of their own compliance with the DWSNZ.

The following text may be used or adapted by water suppliers.

### **DRINKING WATER STANDARDS COMPLIANCE**

As part of compliance with the *Drinking-water Standards for New Zealand 2005 (Revised 2008)*, the [insert name of water supplier or council] is legally required to publish the following notice.

#### **DRINKING WATER Public Notice**

Some plumbing fittings have the potential to allow minute traces of metals to accumulate in water standing in the fittings for several hours. Although the health risk is small, the Ministry of Health recommends that you flush a mugful of water from your drinking water tap each morning, before use, to remove any metals that may have dissolved from the plumbing fittings. We recommend this simple precaution for all households, including those on public and private water supplies.

[Name]

[Position title, eg, CEO water supply or council]

This notice is placed by [insert name of council or water supplier], in relation to the [insert name of water supply /water supplies in their district – select appropriate text].

Plumbosolvency is also discussed in sections 10.3.2, 10.3.3 and 10.4.2, and in the Aggressiveness datasheet (Appendix 2.4). Corrosion is discussed in section 10.3.4 of the Guidelines.

## **Flushing taps**

Taps, and the fittings connecting them to the internal reticulation system of a house, appear to be the primary sources of the heavy metals lead, nickel and cadmium. The materials used in the remainder of the pipework in the dwelling generally contribute little to the concentrations of these metals in the water. As a result, water that has stood in the taps is likely to contain higher concentrations of lead, nickel and cadmium than water that has stood in the pipes. Where copper pipes are used, the situation is different, and copper is likely to be present in water that has stood in the service pipes from the toby.

Taps and their immediate fittings contain only a small volume of water, generally in the range 50–120 mL. Because these are the main sources of heavy metals in New Zealand's drinking water, a correspondingly small flush of water is all that is required to obtain a flow of water with metal concentrations less than 50 percent of their MAV (Nokes 1999).

There are two situations in which flushing the tap may not reduce the metal concentrations to acceptable levels:

- houses in which the internal plumbing is copper. Plumbosolvent water that has been standing in contact with the copper pipes is likely to contain elevated levels of copper (ie, cuprosolvency). A small flush volume (500 mL) will therefore remove metals dissolved from the tap and immediate fittings, but the subsequent volume of water will contain the copper dissolved from the pipes. A sufficiently long flush will eventually clear water from the house pipes and should result in lower metal concentrations, but flushing this volume may be impracticable in large buildings or dwellings on back sections. A dripping cold tap can often indicate corroding copper systems by the blue stain on baths and basins.

Concerns about copper in these situations are usually less than those for other metals because the MAV for copper is much higher than those of the other corrosion-derived metals. Instances of copper concentrations exceeding 50 percent of its MAV consequently occur less frequently than for other metals. However, there are situations where corrosion of copper tubing has resulted in health effects. Brodlo et al (2005) reported a case in an Australian school where several pupils became ill. Copper concentrations in the range of 6–43 mg/L were found in the initial response sampling. Copper levels fell to 1–3 mg/L after remedial action, with no further illness

- houses supplied by rainwater. In these systems, unless care has been taken with the selection of the roof and guttering materials, all the collected rainwater may contain high concentrations of heavy metals, particularly lead. Flushing the tap may reduce the initial concentration of heavy metals, but the residual metal concentrations present in the rainwater may not be reduced further by flushing because lead could be present in all the water in the holding tank.

## 10.3 Monitoring programme design

### 10.3.1 Drinking-water Standards for New Zealand

The DWSNZ prescribe what is required to demonstrate chemical compliance for a community drinking-water supply.

Due to the large number of determinands of health significance covered by the DWSNZ, four Priority Classes have been established to ensure that resources are concentrated on likely problems, see section 3.3 in the DWSNZ and section 1.6.9 of the Guidelines. Only Priority 1 determinands (micro-organisms) and any chemical determinands specified by the Ministry of Health as Priority 2 determinands for a specific drinking-water supply need to be monitored to establish compliance with the DWSNZ. Priority 2 determinands for a supply will be notified directly to the manager of that supply and listed in the *Register of Community Drinking-Water Supplies and Suppliers* published by the Ministry of Health. Priority 2 determinands are discussed in greater detail in section 10.3.2. Supplies and zones with P2s can be found at <http://www.drinkingwater.esr.cri.nz/supplies/priority2determinands.asp>

There are three types of Priority 2 chemical determinands:

- Priority 2a      Chemical determinands which could be introduced into the drinking-water supply directly by the treatment chemicals at levels potentially significant to public health (usually greater than 50 percent MAV).
- Priority 2b      Chemical and radiological determinands of health significance that have been demonstrated to be in the drinking-water supply at levels potentially significant to public health (usually greater than 50 percent MAV). Cyanotoxins are also Priority 2b determinands but require special attention – see Chapter 9.
- The Priority 2b substances are divided into two further types:
- Type 1 where the concentration is unlikely to vary during distribution
  - Type 2 where the concentration may vary during distribution.
- Priority 2c      Chemical determinands of health significance, usually a metal, that may appear in drinking-water, having arisen from consumers' plumbing or fittings. When the concentration of a metal in a non-flushed sample, less its concentration in a flushed sample, is more than 50 percent of the MAV, the metal is assigned Priority 2c.

Chemical compliance for Priority 2a and 2b determinands is assessed on the results of sampling carried out over a 12-month period. For chemicals that have been classed as Priority 2a and 2b determinands, the compliance criteria listed below must be met:

- samples are taken at the required sites and frequency for the determinand in question
- the sampling and analytical techniques comply with the requirements of the DWSNZ
- for determinands which are sampled either weekly or monthly, no samples can transgress the MAV during 12 months of monitoring
- where two or more determinands are present which cause similar toxicological effects, the sum of the ratios of the concentration of each determinand to its respective MAV shall not exceed one for compliance with the DWSNZ.

EXAMPLE, using nitrate and nitrite:

(MAVs: nitrate – 50 mg/L NO<sub>3</sub>; nitrite – 3 mg/L NO<sub>2</sub>)

if a drinking-water contains:

- 7 mg/L nitrate as N (which = 31 mg/L nitrate as NO<sub>3</sub>), plus
  - 0.4 mg/L nitrite as N (which = 1.31 mg/L as nitrite as NO<sub>2</sub>), then
  - the sum of the ratios =  $31/50 + 1.31/3 = 1.06$  which, being greater than 1, exceeds the condition in the MAV Table, despite the concentrations of the individual chemicals each being less than their respective MAVs.
- the procedure outlined in section 8.4 of the DWSNZ *Chemical Transgressions and Remedial Action* is followed and the results and actions documented.



If the results from 12 successive months' monitoring for a Priority 2a or 2b chemical determinand are all less than 50 percent of the MAV for that determinand it is possible that the determinand in question may be relegated to Priority 3 and compliance monitoring may cease. This decision is at the discretion of the Medical Officer of Health.

The following sections explain the reasons behind the above compliance criteria and illustrate how to set up monitoring programmes and assess chemical compliance according to the DWSNZ. In addition, section 10.3.4 provides information about how and why discretionary monitoring may be carried out.

## 10.3.2 Priority 2a and 2b chemical determinands

The concept of Priority determinands is in the process of being changed. The DWSNZ (2008) said in section 3:

Priority 2 determinands are divided into four types: Priorities 2a, 2b, 2c and 2d.

- *Priority 2a* determinands are chemical and radiological determinands that could be introduced into the drinking-water supply by the treatment chemicals at levels potentially significant to public health (usually greater than 50 percent of the MAV).
- *Priority 2b* determinands are chemical and radiological determinands of health significance that have been demonstrated to be in the drinking-water supply at levels potentially significant to public health (usually greater than 50 percent of the MAV).

Priority 2b includes chemicals present in the raw water that may not be removed by the treatment process, any disinfection by-products, and determinands introduced into drinking-water from the distribution system other than the consumer's plumbing, or other materials present in the water when sampled under flushed protocols.

Cyanotoxins can develop rapidly in surface waters, and many treatment processes will not remove them. There is no simple relationship between their occurrence and the concentrations of the cyanobacteria that produce them. Because of this, and because they are very toxic, the monitoring requirements differ from those of most other Priority 2b chemical determinands.

- *Priority 2c* determinands are chemical determinands of health significance that may appear in consumers' drinking-water having arisen from their plumbing or fittings.

**Plumbosolvent water** is a category of drinking-water in which metals of health concern are generally found in the first portion of water collected from the tap but occur at a much lower concentration after flushing the tap; metals in the water after flushing are Priority 2b determinands. Priority 2c determinands are produced by the corrosion of the consumer's tap and associated fittings so that one or more metals (eg, lead, nickel, cadmium or antimony) dissolve or scour into the water. See Guidelines, sections 10.2.6, 10.3.3 and 10.4.2.

Similarly, the copper MAV may be exceeded at the consumer's tap, particularly when water containing free (aggressive) carbon dioxide causes corrosion of copper tubing.

Three types of Priority 2 chemical determinands exist.

- *Priority 2a*: Chemical determinands that could be introduced into the drinking-water supply by chemicals at the treatment plant at levels potentially significant to public health (usually greater than 50 percent of the MAV). Priority 2a does not include disinfection by-products or determinands introduced into the drinking-water from piping or other construction materials.
- *Priority 2b*: Chemical determinands, other than those introduced by the treatment chemicals, that have been demonstrated to be in the drinking-water supply at levels potentially significant to public health (usually greater than 50 percent of the MAV). Priority 2b includes determinands present in the raw water (some or all of which pass through the treatment process), disinfection by-products, cyanotoxins (see section 7) and determinands introduced into the drinking-water from the water supplier's piping or other construction materials.
- *Priority 2c*: Chemical determinands of health significance, usually a metal that may appear in tap water, having arisen from consumers' plumbing or fittings. When the concentration of a metal in a non-flushed sample, less its concentration in a flushed sample, is more than 50 percent of the MAV, the metal is assigned Priority 2c.

Priority 2c determinands arise from a property of the water supply, called 'plumbosolvency' in these standards. The DWSNZ do not cover elevated concentrations of metals of health concern caused by poor grade domestic plumbing, fittings or faulty installation.

- *Priority 2d* relate to micro-organisms.

And in section 8:

#### 8.1.1.1 Compliance criteria for Priority 2a determinands

Compliance can be demonstrated by using the certified analysis of water treatment chemicals and calculating whether any determinands are Priority 2a.

Expand in 10.3.1

#### 8.1.1.2 Compliance criteria for Priority 2b determinands

Priority 2b determinands comprise two types.

- *Type 1*: substances whose concentration is unlikely to vary in the distribution system.
- *Type 2*: substances whose concentration may vary in the distribution system.

The Ministry of Health's Priority 2a and 2b Chemical Determinands Identification Programme (Priority 2 Programme) identifies Priority 2a and 2b chemical determinands in drinking-water supplies serving more than 100 people. Samples are taken under worst-case conditions, and only one test result exceeding 50 percent of a determinand's MAV is sufficient for a recommendation to be made for a Priority 2a or 2b assignment. These two policies are intended to compensate to some degree for the limited number of samples that can be taken from a water supply during its assessment.

The assignment of a Priority 2a or 2b determinand to a water supply does not imply that the Priority 2 programme has determined that the determinand will always exceed 50 percent of its MAV. The purpose of the programme is to identify determinands that may be present at potentially health-significant concentrations. It is the task of the compliance monitoring programme (required for Priority 2a and 2b determinands) undertaken by the water supplier to establish, more reliably than the Priority 2 programme is able, the levels at which the determinand is present in the water. The *Annual Review of Drinking-water Quality in New Zealand* has shown that the results of compliance monitoring in 2003 supported the assignments made through the Priority 2 programme (ie, at least one sample taken exceeded 50 percent of its MAV) in approximately 57 percent of monitored supplies.

Three pieces of information are required as the starting point for the design of a compliance monitoring programme:

- the identity of the determinands that must be monitored
- the site at which samples must be taken
- the frequency with which samples must be taken.

For a particular supply, the Ministry of Health will use all the relevant data available to identify the Priority 2a and 2b chemical determinands that have to be monitored. Water supply owners will be notified of the determinands from Tables 2.2 and 2.3 in the DWSNZ that are classified as Priority 2 for their supply by the Ministry of Health by letter through the District Health Board. The assignments will also be published in the *Register of Community Drinking-Water Supplies in New Zealand*. Compliance monitoring of Priority 2a and 2b determinands must start from the date of notification, not with the date of publication in the *Register*.

For all compliance monitoring, the drinking-water assessor must approve the monitoring programme planned by the supplier. It is also advisable for approval to be obtained if a water supplier wishes to collect data to challenge a Priority 2a or 2b determinand assignment proposed by the Ministry of Health.

To challenge a proposed assignment, a water supplier needs to support their case with monitoring data that have been collected using the same protocols as required for compliance monitoring. The results of tests carried out by the Priority 2 programme can provide the water supplier with an unofficial indication of the likely assignments the Ministry of Health will propose. A copy of the test report should be provided to the water supplier by the district health board about four weeks after the sample is taken. Any determinand identified in this report as exceeding 50 percent of its MAV will be recommended to the Ministry for assignment as a Priority 2a or 2b determinand, unless there are extenuating circumstances. Therefore, if the water supplier considers that the

result from the Priority 2 programme test is not representative of the water quality, or the supplier takes steps to reduce the determinand's concentration, a monitoring programme, approved by the drinking-water assessor, should be carried out to support their challenge to the assignation when it is proposed.

Undertaking this discretionary monitoring, if it shows the target determinand's concentration is less than 50 percent of its MAV in all samples, has the advantage for the water supplier of avoiding publication of the determinand as a P2 determinand for the supply.

The source of the determinand and the likelihood of its concentration changing within the distribution system establish the appropriate sampling locations. Selection of the sampling sites for Priority 2a and 2b determinands should be carried out in accordance with Table 8.1 and Tables A2.1 to A2.4 in the DWSNZ. The sampling location for all Priority 2a determinands is, as set out in Table 8.1 in the DWSNZ, always the finished water leaving the treatment plant.

Table 8.1 in the DWSNZ indicates that samples for monitoring Priority 2b determinands are taken from the water leaving the treatment plant, or from the distribution zone. Sampling from the water leaving the treatment plant is adequate for the Priority 2b, Type 1 determinands because their concentrations are not expected to change during distribution. It is permissible to sample these determinands from the distribution zone, if this is more convenient. Priority 2b, Type 2 determinands, on the other hand, must be taken from the distribution zone because they are likely to change during distribution.

Tables A2.1 to A2.4 can be used to determine whether a determinand is a Priority 2b, Type 1 or Type 2 determinand. The Sampling Location column is subdivided into two sub-columns headed TW – treated water, and DZ – distribution zone. A tick only in the DZ column indicates that the sample must be taken from the distribution zone because the concentration of that determinand may change during distribution (Type 2). Ticks in both columns indicate that samples may be taken either from the water leaving the treatment plant or in the distribution zone because the concentration of the determinand does not change in the distribution system (Type 1).

The last of the three pieces of information needed to design a monitoring programme is the frequency of sampling. The sampling frequency for Priority 2a determinands depends on the determinand in question. All Priority 2a chemical determinands must be monitored at least monthly except for fluoride and chlorine. Fluoride must be monitored at least weekly if the supply is fluoridated,<sup>3</sup> and chlorine must also be monitored weekly if it is assigned as a Priority 2a determinand to the treatment plant, that is, if the concentration is likely to exceed 50 percent of the MAV. Note that if chlorine monitoring is being undertaken for bacterial compliance purposes, the frequency of monitoring required will usually be much higher; see Table 4.3a of the DWSNZ for water in the distribution system. Well-managed supplies will carry out process control monitoring at much higher frequencies than these minimum frequencies. If this is done, and the monitoring protocols meet the requirements of the DWSNZ these monitoring results can be used to demonstrate compliance.

<sup>3</sup> Water suppliers that fluoridate may wish to refer to NZWWA (2014a and b).

All Priority 2b, Type 1 determinands must be sampled at least monthly. Although the minimum sampling frequency for Priority 2b, Type 2 determinands is monthly, it may be appropriate for additional samples to be taken to provide a better understanding of the range of concentrations of the determinand. Table 8.1 in the DWSNZ does not specifically state where samples from the distribution zone are to be taken, but fixed and random sampling sites may be used.

Fixed sites are of use when trends in the water quality with time are of interest, because other factors that may change with geographical position, such as the composition of distribution system materials, remain fixed. Changes in determinand concentrations may result from changes in source water quality, changes in the treatment processes, or changes water flows through the network.

Random sampling sites may be used in conjunction with fixed sites to gather more information about the way in which a determinand's concentration is influenced by geographical location. This will help establish how representative monitoring from the fixed sites is. Furthermore, when the geographical distribution of possible contamination sources within a reticulation network is unknown, eg, the construction materials used and their whereabouts are uncertain, random sampling will help in determining where these sources may be.

The sampling locations that will provide the most useful information for a Priority 2b, Type 2 determinand will depend on the characteristics of the supply and the determinand in question. Specific rules cannot be set down for many of the determinands. Some of the factors to take into account in selection of sampling locations and frequencies for determinands being monitored in the distribution zone are discussed below.

Once the appropriate sampling area of the distribution zone has been identified for the particular determinand, some sampling should be carried out at fixed sites so water quality trends can be followed. Further sampling at random sites may be useful to investigate:

- the effects of different reticulation materials on water quality
- the spatial and temporal effects on drinking-water quality
- how representative the selected fixed sites are.

## Metals

The following discussion will assist in sample site selection for heavy metal monitoring.

- 1 **If the metal is present in the source water (Priority 2b Type 1):** The metal will be carried to all parts of the reticulation system, therefore any sampling location should be acceptable, ie, water leaving the treatment plant, or fixed or random locations in the distribution system can be used.
- 2 **If the metal arises from the reticulation network (Priority 2b Type 2):** Specific sampling locations are needed to ensure that water that has been in contact with the source of the metal is monitored, ie, fixed locations are needed.

- 3 **If the metal is found in water in buildings supplied by the reticulation network (corrosion as the result of aggressive or plumbosolvent water, Priority 2c):** two options arise for assessing the aggressiveness of the water:
- make use of a number of randomly selected buildings, because although some consumers' plumbing may be more likely to leach metals than others, this information is generally not known prior to monitoring, or
  - install standard plumbing fittings that are directly connected to the reticulation network, see section 10.3.3 of these *Guidelines*.

## Disinfection by-products

Most disinfection by-products (DBPs) are not formed instantly when a water is disinfected. Slow steps in the process result in continuing formation over a period of days. Formation rates increase with temperature. The concentrations of most DBPs thus increase with time and therefore distance from the treatment plant. They can also increase after rechlorination. In general, maximum DBP concentrations will be found after service reservoirs and at the extremities of the distribution zone, as these situations are where the disinfectant will have been in contact with the water for the longest time. Note however that the haloacetic acids can biodegrade where biological activity is present and disinfectant residual levels are low or non-existent.

Samples taken at the treatment plant, or close to it, will contain the lowest disinfection by-product concentrations in the system, as the reaction time for their formation is very short. Samples taken at these points are unsatisfactory for compliance monitoring purposes.

To obtain valid information on disinfection by-product concentrations from monitoring samples it is also necessary to be certain that the chlorination system has been operational for the previous three or four days, and that satisfactory chlorine residuals have been maintained at the extremities of the zone.

DBP concentrations are related to the composition and concentration of natural organic matter in the raw water, which can be seasonal or variable. A simple technique for predicting when the maximum DBPs may occur is to monitor the raw water for UV absorbance, measured at 254 nm.

The sampling schedule for disinfection by-products must be provided to the DWA before the monitoring starts. This is to ensure that sampling is undertaken randomly with respect to the source water quality and times of good water quality cannot be selected for sampling, thereby reducing the concentrations of by-products found.

A worked example for this type of substance is given for bromodichloromethane further on in this section. See Chapter 15: Treatment Processes, Disinfection, section 15.4 for further discussion about disinfection by-products.

## Substances derived from materials within the distribution system

Contaminants, such as heavy metals from pipes, gaskets or fittings, and polycyclic aromatic hydrocarbons (PAH) from coal tar-lined pipes, may be leached into the water as it travels through the reticulation network. In general, longer contact times between the water and reticulation construction materials will lead to an increase the contaminant concentration in the water.

Different construction materials may be present in different parts of the distribution zone. Knowledge of the types of material that are in contact with the water, and their locations, is necessary to evaluate the best sampling locations for specific determinands. In the absence of construction material information, randomly selected sampling locations towards the extremities of the distribution zone provide the best chance of detecting the determinands of concern. At these locations, the water is most likely to contain any available contaminants because of the length of time it has been in the network. Most local authorities should now have a reasonably accurate database describing the materials within their network.

See Chapter 16: Distribution System, section 16.2.6 for a discussion on permeation and leaching of chemicals (usually organic) from and into pipes.

## Substances that precipitate and deposit within the distribution system

These include some metals, such as manganese, that may have been in a soluble form in the source water but are slowly oxidised following treatment. The oxidised form is insoluble, and in parts of the distribution system where the water flow is low, compounds of these metals may settle to form deposits within the pipes. Lime leaching from concrete lining of pipes may increase the pH of the water at the pipe-water interface, facilitating or accelerating chemical reactions. Chemicals added during water treatment may disturb the chemical equilibria in treated water. This can result in post-treatment precipitation in the distribution zone. In volcanic areas of the North Island, source water may be supersaturated with silica compounds that precipitate in the distribution.

The concentrations of these substances may vary both with time and geographical position. Their concentrations may drop in parts of the distribution system when there is the opportunity for them to settle. At other times, and in different locations, their concentration may increase due to deposits in the pipes being disturbed by increased or reversed flows.

Samples from the distribution system close to the treatment plant will provide information about the likely maximum concentrations of the substance to which consumers will be routinely exposed. If deposition of contaminants is occurring throughout the distribution system the concentrations may be lower for consumers at the far ends of the distribution. Occasionally however, when the deposits are disturbed, significantly higher concentrations than those found close to the treatment plant may arise in the water. These episodes will be hard to monitor because of their random nature, and are unlikely to fit neatly into a planned monitoring programme. Consumer complaints of black, or coloured, water may prove to be the best guide to where and

when samples for this type of substance should be collected. The purpose of compliance monitoring is not to determine the cause of such problems; the water supplier may have to undertake a separate programme to provide this information. See Chapter 18: Aesthetic Considerations for further discussion about dirty water.

## Substances that are consumed as they pass through the distribution

The most common examples of this type of substance are the disinfectants, eg, chlorine. In most instances, chlorine will be monitored as part of the bacterial compliance programme, in which case the residuals present at the extremities of the reticulation are of importance. It is also possible for chlorine to be a Priority 2a determinand if it is being dosed heavily. Excesses may perhaps arise through poor dosing control, or because the poor condition of a distribution system requires high chlorine doses to maintain a satisfactory chlorine residual throughout. Where a high concentration of the disinfectant is a concern, samples should be taken from the water leaving the treatment plant.

Rechlorination may be needed in large distribution systems to ensure adequate residuals in all parts of the distribution system. In supplies where this is done, other sampling locations, in addition to those near the treatment plant, will need to be selected.

The example of chlorine is discussed more fully in a worked example later in this section.

Other substances that may be consumed in the distribution system include dissolved oxygen and nitrate (by bacteria in biofilms or corrosion build-up), and carbon dioxide (in corrosion processes).

## Substances derived from the dissolution of plumbing materials in dwellings

The main class of substances in this category are the heavy metals. Copper may come from copper pipes. Taps and fittings are the source of the other metals, mostly lead and nickel. Sampling for corrosion-derived metals is discussed in sections 10.3.3 and 10.4.2, but note that metals from these sources are an indication of the aggressiveness or plumbosolvency of the water, and do not lead to the assignment of Priority 2a or 2b determinands.

## Worked examples for planning a monitoring programme

The following worked examples demonstrate how information in the DWSNZ can be used to design monitoring programmes. The heading for each example states the sources of the determinand considered in that particular example rather than considering all possible sources for that determinand. Some determinands can be both Priority 2a and 2b depending on the situation.



- 1 **Acrylamide** (introduced with polyacrylamide water treatment chemicals): If acrylamide is present because of water treatment processes (Priority 2a), samples should be taken from the water leaving the treatment plant on a monthly basis.

Note that the requirement to monitor acrylamide monthly as a Priority determinand can be avoided if it can be shown by calculation that the maximum level of acrylamide in the finished water leaving the plant **cannot** exceed 50 percent of the MAV by virtue of the maximum dose rate used and the verified contaminant level in the polyacrylamide product.

- 2 **Arsenic** (source water contaminant): Arsenic is a Priority 2b Type 1 determinand because its concentration is not expected to change within the distribution zone. Table A2.1 in the DWSNZ indicates that samples for arsenic could be collected either from water leaving the treatment plant or from water in the distribution system. Where the plant feeds more than one distribution zone, monitoring would be minimised by taking one sample from the water leaving the plant rather than in each distribution zone.

- 3 **Fluoride** (dosed into the supply during treatment): The acceptable concentration range for intentionally added fluoride is 0.7–1.0 mg/L as F. The MAV for fluoride is 1.5 mg/L, and as a result, fluoridation of a supply places fluoride in the Priority 2a class. Table 8.1 in the DWSNZ requires a weekly minimum sampling frequency for fluoride with samples being taken from the water leaving the plant. This sampling frequency may be superseded by the requirements for controlling fluoride when dosed for oral health purposes; a drinking-water assessor will be able to advise on the requirements.

- 4 **Chlorine** (intentionally added during treatment): Chlorine is added to water as a treatment chemical for disinfection purposes. The two aspects to the monitoring requirements for chlorine are:

- 1 microbiological requirements that the chlorine residual in the reticulated water is sufficient to achieve adequate inactivation of micro-organisms
- 2 chemical compliance requirements that the concentration in the water does not exceed the MAV of 5 mg/L as chlorine.

In terms of its classification for chemical monitoring, chlorine is a Priority 2a determinand (because it is added during treatment), and it is required to be tested in the water leaving the treatment plant. Its high reactivity with other components in the water and material coating the distribution pipework results in a continuous drop in the chlorine concentration as the water passes through the reticulation network. Sampling at the treatment plant therefore provides a measure of the highest concentration to which consumers may be exposed (those living closest to the treatment plant).

Table 8.1 (DWSNZ) notes that the sampling frequency for chlorine monitoring must be at least weekly.

It is important that the monitoring requirements for chlorine as a Priority 2a determinand are not confused with those for microbiological monitoring. Chlorine monitoring for microbiological purposes must either occur at the treatment plant at the frequency given in section 4.3 (DWSNZ) or in the distribution system at the frequencies specified in section 4.4.

- 5 **Bromodichloromethane** (disinfection by-product): Bromodichloromethane is a disinfection by-product produced from the reaction of chlorine with bromide and natural organic matter in water. The reactions producing bromodichloromethane will continue in finished water after it has left the treatment plant, and as a result this substance is classified as a Priority 2b, Type 2 determinand. Tables A2.2b and 8.1 in the DWSNZ show that the determinand must be monitored in the distribution system, and that monthly sampling is required.

Like all disinfection by-products, the concentration of bromodichloromethane is likely to vary with changes in the various factors influencing its formation, such as the amount of organic matter in the water. Where possible more than the minimum of 12 monthly samples should be taken to establish better the range of concentrations that may appear in the treated water. Monthly sampling for disinfection by-products is a bare minimum if a good indication of their variability is to be gained. These additional samples may be taken from randomly selected locations, and their number should increase with the size of the distribution zone.

The monitoring programme should provide information on the maximum bromodichloromethane concentration being supplied to consumers. Maximum concentrations are likely to be present in sections of the distribution system where the water is oldest, therefore fixed monitoring sites should be positioned at the extremities of the distribution system. Sampling sites can be located at in other parts of the distribution zone if the water supplier wants information about the range of concentrations present in the zone, but it is the sites at the extremities that are required for compliance monitoring.

## Change in status of a Priority 2 chemical

A determinand assigned P2 status can be reassigned a P3 status after sufficient satisfactory monitoring results. However, some further monitoring will be required to confirm that the change in concentration is permanent. See Chapter 1 (section 1.6.9), and the *Priority 2 and Priority 3 Chemical Determinands Identification Guide* produced by ESR for the Ministry in 2015, for discussion about monitoring chemicals that were once P2 but subsequently reassigned as P3.

### 10.3.3 Plumbosolvent water

Plumbosolvent water is called Priority 2c. Several factors can influence the concentrations of metals in water samples. These include the:

- time the water has been in contact with plumbing materials
- temperature of the water
- composition, quality, condition and age of the plumbing materials
- metal surface to water volume ratio
- volume of water recently drawn from the tap
- volume of water in the sample

- velocity of the water as it scoured the pipe/fittings
- chemistry of the water. This may include pH, the carbon dioxide content and whether this has been absorbed by passage through concrete-lined mains, and in some situations, high chloride or sulphate concentrations.

Because of this range of factors, the collection of samples from random locations throughout a distribution system makes reliable assessment of plumbosolvency difficult. As a result, the DWSNZ assumes all water supplies are plumbosolvent; see section 8.2.1.4 of the DWSNZ and section 10.2.6 of these *Guidelines* for subsequent requirements.

Section 8.3.5 of the DWSNZ offers a procedure for demonstrating that a water supply is not plumbosolvent. To reduce variability in results arising from differences in materials at the sampling point, this procedure requires the use of a standard plumbing fitting, fitted directly to the distribution system at a suitable central location, preferably protected, as follows.

## Preparation and use of the standard plumbing fitting

A The sampling procedure is as follows.

- 1 Water that has been standing in the fitting is flushed from it by about 20 L of water being run through it or whatever volume the supplier thinks is necessary to draw fresh water free of corrosion products into the fitting. The 20 L of water is discarded.
- 2 A sample of no more than 150 mL is then taken to allow the lead concentration to be measured in water that has not been standing in the fitting (the flushed sample).
- 3 The water is then allowed to stand in the fitting for a minimum of 12 hours, preferably overnight (see point 3 under the description of the fitting below).
- 4 After the standing time, a sample of no more than 150 mL is taken directly, that is, without flushing the fitting (the unflushed sample).
- 5 The samples are collected and preserved in the manner required by the referee analysis method for lead used by the analytical laboratory or any alternative method (which must be calibrated against the referee method) used by the laboratory.
- 6 The information the water supplier provides at the end of the testing period is:
  - the lead concentration measured in each sample
  - the date and time at which the tap was flushed in preparation for the test (step 1)
  - the date and time at which the sample was taken (step 3)
  - the signatures of the people, or person, responsible for steps 1 and 3.

**Figure 10.1: Standard fitting for testing plumbosolvency**

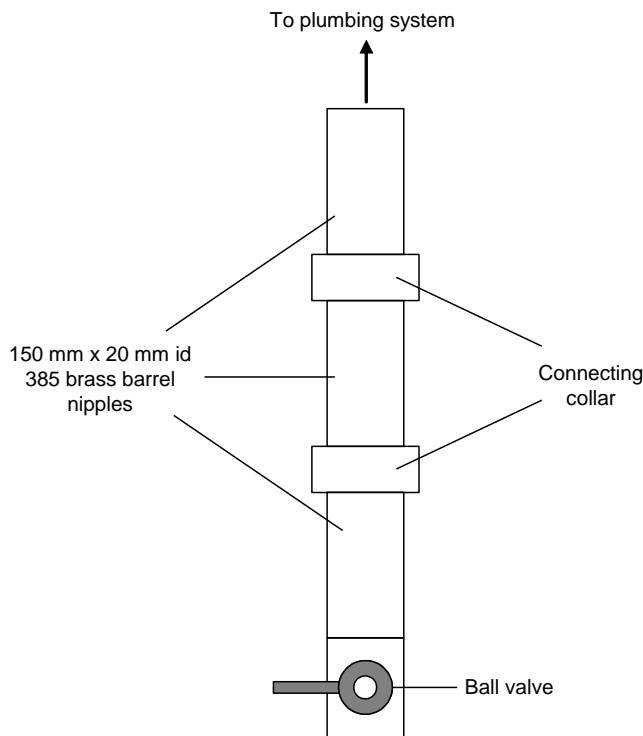

B The standard plumbing fitting specification is as follows.

- 1 The brass selected for the fitting to be used is the AS/NZS 1567 C38500 alloy. This has a relatively high lead content (2.5–4.5 percent) and has been used in the manufacture of some parts of taps. The fitting is a low internal volume ball valve connected to the plumbing system by a mounting nipple of 385 brass (AS1567) having a 20 mm ID and a total internal volume of not less than 140 mL. This arrangement can be achieved by either:
  - a 450 mm length of threaded 20 mm ID 385 brass nipping tube
  - 3 x 150 mm x 20 mm ID 385 brass barrel nipples coupled together (see Figure 10.1).
- 2 The part of the fitting of importance to the test is the mounting nipple. Proof, such as a statement from the manufacturer, that it is composed of 385 alloy should be obtained.
- 3 The fitting is to be mounted inside a building, or otherwise protected against changes in temperature, to minimise temperature drops overnight.
- 4 The fitting should not be mounted close to other taps. This is to avoid the use of other taps disturbing the water standing in the mounting nipple. If this is not possible, the water should stand overnight, when water use is minimal.

C Assessment of non-plumbosolvency

For a non-plumbosolvent water to be identified, monthly pairs of samples must be collected for 12 months. Each pair consists of a sample taken without the sampling point being flushed, and the second after an extensive flush (20 L, or more if necessary). Comparison of the lead concentration in these two samples provides information about its source. An increased difference in the lead concentration points to dissolution of lead from the standard plumbing fitting. If

the difference in the lead concentration between the two samples in any flushed-unflushed sample pair taken during the 12-month monitoring period does not exceed 50 percent of the lead MAV, the water is designated as non-plumbosolvent. Section 10.4.2 covers sampling procedures in more detail.

Sampling arrangements for water supplies with more than one source water need to be discussed with the DWA.

### 10.3.4 Discretionary monitoring

Sections 10.3.2 and 10.3.3 discuss the monitoring of chemical determinands required to demonstrate compliance with the DWSNZ. The water supplier may also wish to obtain information on determinands of aesthetic importance because of consumer complaints, or to collect further data on determinands of health significance. Many industries need to have information about the composition of the water supply. Non-obligatory sampling of this nature is referred to as discretionary monitoring and will often include determinands that can be assigned to the Priority 3 or 4 classes.

Chemical determinands are classified as Priority 3, by default, until assessed as Priority 2 in the process of preparing the Water Safety Plan. Where a water supplier considers that a determinand may be occurring at health significant levels in the supply, but the determinand has not been classified as Priority 2, they should undertake discretionary monitoring to be more certain of the safety of the water being supplied to their consumers. Discretionary monitoring should also be undertaken where assessment by the Priority 2 Programme has resulted in a determinand being classified as Priority 3, but factors influencing the concentration of the determinand have changed since the assessment; see *Priority 2 and Priority 3 Chemical Determinands Identification Guide* produced by ESR for the Ministry in 2015.

The water supplier needs to identify the purpose of a discretionary monitoring programme so that it can be designed appropriately; this will provide a guide to determining sampling locations and frequencies. For example, a sampling programme with the aim of establishing the typical concentration range of a determinand may take samples at random locations on a regular basis. On the other hand, monitoring to establish the cause of consumer complaints should take samples at places where the problem has been found to occur and at times when it occurs.

Discretionary monitoring should be carried out for routine process control, and it may be required to investigate the cause of consumer complaints or troubleshooting water quality problems. Process control monitoring is discussed in Chapter 17. The following discussion deals with consumer complaints and troubleshooting. Aesthetic considerations are also discussed in Chapter 18.

The geographical distribution of consumer complaints is likely to act as a good guide for monitoring locations within the distribution system. Some further factors that should be considered when selecting monitoring sites for aesthetic determinands (those contained in Table A2.1 in the DWSNZ) are discussed below; refer also to Chapter 18: Aesthetic Determinands.

## Corrosion

Corrosion is the deterioration of a substance (eg, water supply asset) or its properties because of a reaction with its aqueous environment. Waters that give rise to corrosion are usually called corrosive. In some instances they may also be termed plumbosolvent, as is done in the DWSNZ (see also section 10.2.6 and Datasheets 2.4: Aesthetic determinands, Aggressiveness).

The build-up of corrosion products in the distribution system or plumbing can shield bacteria from free available chlorine, give rise to coloured water, and can also reduce flow or increase pumping costs.

Not all 'corrosion processes' are electrochemical: designers must be aware that water flowing through copper tube piping systems must not exceed 3 metres per second. When this occurs there is a high risk that the internal bore of the piping system will be eroded by high flow and velocity scouring, see section 10.3.2 in WHO (2006).

DWI (2010) discusses blue water, mainly in new copper pipes in large buildings. They state that blue water is usually caused by unsuitable plumbing, for example, when excess flux or the wrong type of flux is used to join pipes and fittings. Another risk factor is when water is left to stagnate in the newly installed pipes following pressure testing and before occupation of the property. Most recorded cases relate to large public buildings or new housing estates. Blue water is not known to occur when work is undertaken by qualified plumbers and water company approved contractors who will use only approved materials and procedures.

It is known that blue water is less likely to occur if:

- minimum quantities of flux are used
- new pipes are immediately flushed very thoroughly
- water is not left to stand or get warm for long periods in new pipes
- the installation is drained down when it is not put into immediate use.

The phenomenon of corrosion is complex, and many factors affect the rate and extent to which it occurs. Some of the more readily measurable determinands that may have a bearing on the extent of corrosion occurring within a distribution system include temperature, pH, total dissolved solids, calcium, chloride, sulphate, dissolved oxygen, free available chlorine, carbon dioxide, and alkalinity.

In the past stainless steel has been used in an attempt to overcome problems arising from corrosion of copper and galvanised steel pipes, not always with an adequate understanding of the types of stainless steel available and where it can be useful. WRF (2015b) presents guidelines for the use of stainless steel in the water industry.

In the DWSNZ, the designation of a water as plumbosolvent is based on the consequences of corrosion, ie, the appearance of metals in the water that exhibit health effects. However, the **Langelier Saturation Index** (LSI) is often used as a guide to the general corrosivity of a water. The Index should be used as a guide only, and care is required in the interpretation of the results. It can be calculated from measurements of pH, alkalinity, calcium, conductivity (or dissolved solids), and temperature using Table 10.1.

**Table 10.1: Data for calculating the Langelier Index**

| A. Total solids |             | B. Temperature |             |
|-----------------|-------------|----------------|-------------|
| mg/L            | Index value | °C             | Index value |
| 50–300          | 0.1         | 0–1            | 2.6         |
| 400–1000        | 0.2         | 2–6            | 2.5         |
|                 |             | 7–9            | 2.4         |
|                 |             | 10–13          | 2.3         |
|                 |             | 14–17          | 2.2         |
|                 |             | 18–21          | 2.1         |
|                 |             | 22–27          | 2.0         |
|                 |             | 28–31          | 1.9         |
|                 |             | 32–37+         | 1.8         |

| C. Calcium hardness<br>(or calcium expressed as calcium carbonate) |             | D. Methyl-orange alkalinity<br>expressed as calcium carbonate |             |
|--|-------------|---|-------------|
| mg/L CaCO <sub>3</sub>   | Index value | mg/L CaCO <sub>3</sub>  | Index value |
| 10–11  | 0.6         | 10–11   | 1.0         |
| 12–13  | 0.7         | 12–13   | 1.1         |
| 14–17  | 0.8         | 14–17   | 1.2         |
| 18–22  | 0.9         | 18–22   | 1.3         |
| 23–27  | 1.0         | 23–27   | 1.4         |
| 28–34  | 1.1         | 28–35   | 1.5         |
| 35–43  | 1.2         | 36–44   | 1.6         |
| 44–55  | 1.3         | 45–55   | 1.7         |
| 56–69  | 1.4         | 56–69   | 1.8         |
| 70–87  | 1.5         | 70–88   | 1.9         |
| 88–110   | 1.6         | 89–110  | 2.0         |
| 111–138  | 1.7         | 111–139   | 2.1         |
| 139–174  | 1.8         | 140–176   | 2.2         |
| 175–220  | 1.9         | 177–220   | 2.3         |

Table 10.1 can be used to estimate whether water will tend to deposit or dissolve calcium carbonate, by substituting the various index values into the following equation:

$$\text{Langelier Saturation Index} = \text{pH} - (\text{A} + \text{B}) + \text{C} + \text{D} - 9.3$$

The water will tend to deposit calcium carbonate if the LSI is positive and dissolve it if the LSI is negative. To avoid the unwanted effects of a strongly negative or strongly positive index, an LSI value in the range –0.5 to 0.0 is often considered desirable. For a more detailed discussion, see Chapter 17 of AWWA (1990). Many workers have attempted to refine the index, giving rise to slightly different results. An online calculator can be accessed at

<http://www.awwa.org/Resources/RTWCorrosivityCalc.cfm?navItemNumber=1576>

Many of New Zealand's drinking-waters are soft, with a low alkalinity, so the LSI will be well in excess of -2. Dosing lime into these waters to lower the LSI to < -0.5 often results in water with a pH >9. This has a negative impact on some disinfection processes, and may cause aesthetic problems. Lime can be added to water without raising the pH excessively by also dosing carbon dioxide into the water.

The excellent publication by Health Canada (2009) states:

Corrosion indices should not be used to assess the effectiveness of corrosion control programs, as they provide only an indication of the tendency of calcium carbonate to dissolve or precipitate. They were traditionally used to assess whether the distributed water was aggressive towards metals and to control for corrosion. These corrosion indices were based on the premise that a thin layer of calcium carbonate on the surface of a metallic pipe controlled corrosion. Accordingly, a number of semi-empirical and empirical relationships, such as the Langelier Index, the Ryzner Index, the Aggressiveness Index, the Momentary Excess and the Calcium Carbonate Precipitation Potential, were developed to assess the calcium carbonate–bicarbonate equilibrium. However, a deposit of calcium carbonate does not form an adherent protective film on the metal surface. In light of significant empirical evidence contradicting the presumed connection between corrosion and the most common of the corrosion indices, the Langelier Index, the American Water Works Association Research Foundation recommended that the use of corrosion indices for corrosion control practices be abandoned.

The water entering the distribution system should be non-corrosive. A common cause of metallic corrosion and concrete dissolution is the presence of aggressive carbon dioxide, most commonly in groundwaters. Aggressive carbon dioxide is that portion of the free carbon dioxide not required to maintain the carbonate/bicarbonate equilibrium. Its concentration can be calculated using the nomographs in Standard Methods for the Examination of Water and Wastewater (APHA, AWWA, WEF), (4500-CO<sub>2</sub>, 22nd edition, 2012). A high level of carbon dioxide can strip copper from brass and some bronzes and can dissolve copper tubing. The effects of high concentrations of carbon dioxide can become apparent within a few months of commissioning a new bore water supply; it has been known to 'dissolve' pumps inside a year. A blue stain on porcelain beneath taps is a sure sign of copper corrosion. Carbon dioxide also assists in the removal of the galvanising from coated steel, initially causing quite high levels of zinc in the drinking-water, and when the coating has gone, quite high concentrations of iron.

A common form of brass corrosion is dezincification, which occurs particularly with the cheaper duplex brasses. Turner (1961) observed a relationship (Figure 10.2) between chloride and temporary hardness levels that indicated the likelihood of dezincification. Dezincification of brass fittings such as Ajax valves can interfere quite seriously with the operation of hot water cylinders, such as causing the cylinder to leak or even (rarely) rupture. Fittings are available now that are fairly resistant to dezincification.

Monitoring of metals to investigate their origin is discussed under *Metals* below, and in sections 10.2.6 and 10.3.2.



Where the source water of a supply is known to be corrosive, and treatment processes are in place to reduce the corrosiveness, process control monitoring in the treatment plant should be in place to check that water with an acceptable chemistry is being produced.

As an alternative to the Langelier Saturation Index AWWA (1990) recommends in Chapter 17 that the Larsen Ratio (LR) for waters in ferrous materials should be less than 5, where:

$$\text{LR} = \frac{\text{chloride} + 2 \times \text{sulphate}}{\text{bicarbonate}}$$

The selection of fittings used in buildings is not covered by the Health Act so generally falls outside the water supplier's control. It is covered by the Building Code. All building work in New Zealand must comply with the Building Code, even if it doesn't require a building consent. This ensures buildings are safe, healthy and durable for everyone who may use them. The Building Code clause that covers lead leaching into the potable (drinking) water is G12 Water Supplies. New building work must comply with the Building Code.

- G12.3.1 Water intended for human consumption, food preparation, utensil washing or oral hygiene must be potable.
- G12.3.2 A potable water supply system shall be –
  - (a) protected from contamination; and
  - (b) installed in a manner which avoids the likelihood of contamination within the system and the water main; and
  - (c) installed using components that will not contaminate the water.

There have been several instances in New Zealand and Australia where substandard fittings have been imported; the Master Plumbers may be able to assist with enquiries.

## Scaling/deposit formation

Scale formation occurs most frequently from calcium carbonate or, occasionally, calcium sulphate precipitation. Silica deposition can also arise in some cases, particularly in the volcanic regions of the North Island. The tendency for a water to precipitate calcium carbonate can be estimated using the Langelier Saturation Index, which requires measurement of pH, alkalinity, calcium, conductivity and temperature. See the discussion above. Magnesium salts can precipitate out at very high pH, say over 10.

To help in interpreting results from samples taken in the reticulation, water leaving the treatment plant must be sampled. Signs of precipitation may not be evident directly after the plant, but the chemistry of the water may be such that reactions with reticulation materials in the distribution system produce water with a tendency to deposit calcium carbonate. In the event of complaints being received, monitoring sites will need to be selected in the distribution zone to determine whether the problem is spread throughout the whole system, or whether it is localised to a particular section.

Where the source water of a supply is known to be hard (high calcium which may lead to scale formation) and treatment processes are in place to reduce the hardness, process control monitoring in the treatment plant should be in place to ensure that scale-forming water is not leaving the plant.

**Figure 10.2: Influence of water composition on meringue dezincification**

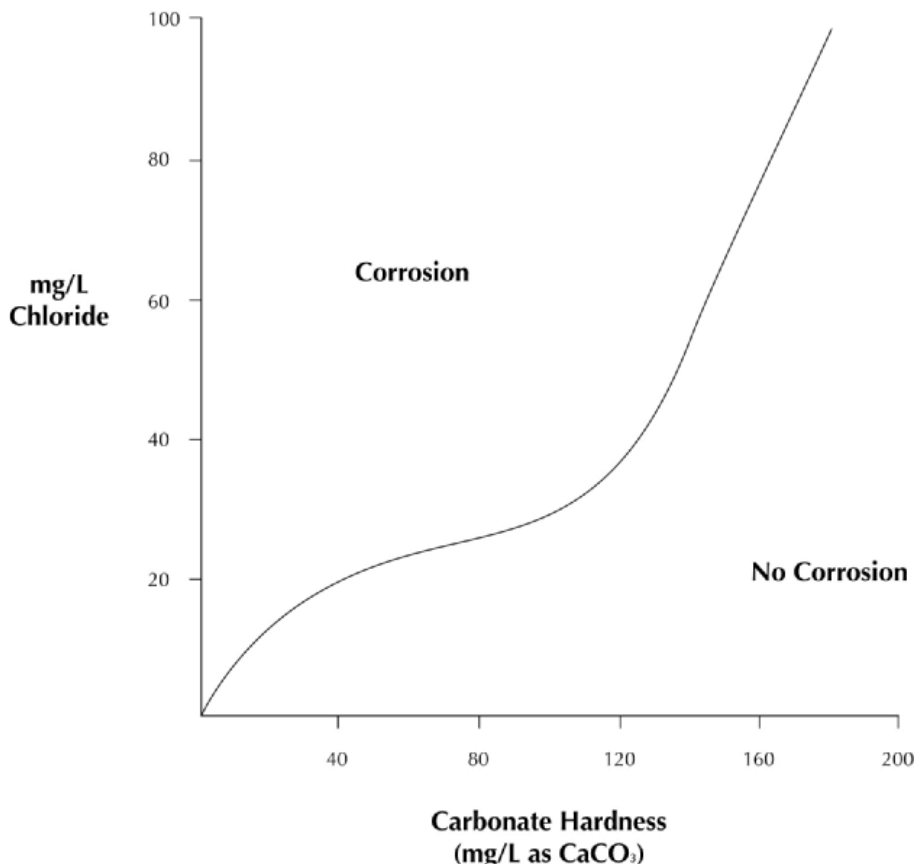

## Metals

Metals in drinking-water can cause taste and staining problems. Staining problems are usually associated with iron, copper and manganese. Taste problems are usually due to iron, copper, manganese or zinc. The metals that usually appear at the highest concentrations are iron, copper and zinc. Iron and zinc may arise from iron pipes or galvanised or brass fittings in the distribution system. Copper is more likely to arise from the corrosion of the consumer's own plumbing, although both iron and zinc may also appear in water from the dissolution of materials on the consumer's property.

When investigating the appearance of metals in drinking-water, information about the metal concentrations in the source water, after treatment, and in the water at consumers' taps is required. Samples taken from the water leaving the treatment plant establish the background levels of metals in water entering the distribution system. Where metals, such as iron or manganese, need to be removed by treatment, samples taken following treatment will show the effectiveness of the treatment process.

Metal concentrations measured in the first volume of water drawn from a consumer's tap arise from metals in the water supplied to the consumer and corrosion of the consumer's plumbing fittings. The difference between the metal concentration in unflushed water and that in a sample taken after a substantial volume of water has been flushed from the tap shows the contribution to the metal concentration made by the tap (and nearby fittings). This is discussed in section 10.2.6 and further in section 10.3.3.

High metals concentrations in water supplied to consumers, if not present in the water leaving the treatment plant, may result from corrosion of materials within the reticulation network, or the mobilisation (by sporadic high water velocities) of metals that have been gradually deposited in parts of the network over time. Consumer complaints may be helpful in locating suitable sites to understand the origins of these metals.

## High dissolved solids

High levels of dissolved solids in water can lead to scaling, taste, and enhanced corrosion. High levels of calcium have already been considered under Scaling. Anions and cations that often appear at elevated concentrations in water include bicarbonate, chloride, sodium and sulphate, although only the last three have been given guideline values in the DWSNZ.

Silica can reach high concentrations in groundwater and can cause problems in some boilers.

Some treatment processes may affect the concentrations of these ions during treatment. Ion-exchange softening resins in the sodium form for removing high calcium concentrations will release high levels of sodium back into the water in exchange for the calcium removed. Although changes in the concentrations of the ions may occur as the result of treatment, their concentrations will not change during distribution. A single monitoring point where the water leaves the treatment plant will therefore be adequate for programmes designed to monitor these ions. Once it is established that the treatment processes do not significantly affect the concentrations of the ions, and that seawater intruded bores are not subject to tidal influence, the monitoring frequency need not be very high.

## Treatment chemical residuals

The carryover of chemical residuals from treatment processes is a major concern for some treatment plants. Process control monitoring is the primary tool by which these residuals should be controlled. The most frequently encountered residual chemical (apart from the chlorine residual) is aluminium, which is added for coagulation purposes and which appears as either soluble aluminium, or pin flocs that have passed through the filters. Manganese (from the use of potassium permanganate) and iron (from the use of iron-based coagulants) are other possible residual substances that will be clearly evident to consumers.

The metal residuals (aluminium, iron and manganese) are best monitored at a series of locations throughout the distribution zone, because of the possibility of their concentrations changing due to precipitation and deposition. For example, aluminium may be predominantly in soluble form leaving the treatment plant, but floc formation can recur in the distribution system. Precipitation of the residual metals in the distribution system may result in the extremities typically having lower concentrations than areas of the distribution zone near the treatment plant, unless these extremities are dead-end mains. Deposits that develop in the distribution system may, from time-to-time, be disturbed by changes in water flow (the use of fire hydrants for example) and the concentrations of the metals in regions of the distribution downstream may be subjected to very high concentrations of these determinands. Regular or random monitoring will only record elevated levels of the metals caused by the disturbance of deposits by chance.

## 10.4 Sampling procedures and techniques

### 10.4.1 Chemical determinands

Monitoring programmes usually provide information on the quality of water at a particular point and at a particular time. Obtaining reliable information about the water quality relies on accurate analysis, and upon the sample being taken in a way that will provide the information needed for answering the question the monitoring intends to address.

Chapter 17: Monitoring, Water Treatment and Drinking-water discusses sampling in a general manner, and section 17.2 discusses factors influencing the day of the week for sample collection.

The two most important factors in ensuring that the composition of the water reaching the laboratory is as close as possible to that of the water when the sample was taken are correct sampling and correct preservation. Standard analytical methods provide details on sampling and preservation requirements in addition to analytical detail. The necessary sampling and preservation requirements for a determinand should therefore be obtained from the analytical method chosen. Tables A2.1–A2.4 in the DWSNZ list referee methods and some sampling information. Other analytical methods may be acceptable, see section 10.5.

Although analytical methods state the specific sampling and preservation requirements, there are good sampling practices that are generally applicable. These are discussed below.

## i) Correct sampling

Correct containers are essential. The testing laboratory usually provides the containers, but at the beginning of the programme, and at any time when a new laboratory is used, a check should be made to determine what the laboratory's requirements are. The Referee Methods specify the container-type and preservative needed, but laboratories do have their own ways of meeting these requirements in terms of the volume of sample they require for each determinand.

Containers must be made of the correct material. As a rule, samples for organic determinand testing must be collected in glass bottles. Plastic containers are satisfactory to collect samples for inorganic substances and physical determinands except for chlorine, chloramines and mercury; which require glass containers.

The container must also be properly prepared, eg, acid washed, solvent rinsed. The details for each determinand will be specified in the method of analysis chosen. It must not be assumed that a sterile container prepared for microbiological sampling is satisfactory for chemical sampling, or vice versa. Sampling personnel must be made aware that the correct sample bottle must be used if valid test results are to be obtained.

Care is required when samples are taken with regard to air gaps above the sample. For chemical samples, fill all containers to eliminate air gaps. (This precaution is not necessary for all determinands, but by doing it as a matter of course sampling personnel do not have to remember the determinands for which it is important and those for which it is not.)

Leaving an air gap above the water allows volatile chemical components to move from the water into the air space, which alters the concentration of the substance in the water. This will happen with small, volatile organic compounds (ie, the trihalomethanes, and other halogenated hydrocarbons, and also carbon dioxide) whose escape from the water may significantly alter its pH.

The top of the sampling container must be removed without touching the inside of the top or the top rim of the bottle. The top should then be placed upside down in a place where it cannot be contaminated while the bottle is being filled.

Care must be taken when filling containers to avoid the loss of any preservative used. Chemical sampling containers holding preservative must not be rinsed. Bottle rinsing should not be necessary for any chemical sample, although unpreserved chemical sample containers can be refilled if necessary. Overflowing the container is permissible when the bottle contains no preservative.

After filling the container, screw the top on firmly to avoid loss of sample during transit to the laboratory.

The following notes provide advice on sampling from taps and from raw water sources.

- a) **Sampling from a tap:** Except when sampling for metals arising from corrosion (eg, lead, copper or zinc), which is discussed in section 10.4.2, 10–20 L of water should be flushed from the sampling point before collecting the sample.

- b) **Sampling from a stream, river or lake:** Loss of preservative from pre-preserved containers can be a problem when trying to obtain chemical samples from a body of water. To overcome this difficulty, use a clean, unpreserved container to fill the pre-preserved sampling bottle. Hold the unpreserved bottle by the base, facing the top of the bottle upstream. Lower the bottle to a depth of at least 30 cm. In a lake the bottle should be lowered into the water and moved slowly forward in a scooping motion to ensure that water uncontaminated by the sampler is drawn into it. Completely fill the bottle by tilting it to allow the air to escape. Fill the pre-preserved bottle from the unpreserved bottle.
- c) **Sampling from a bore:** If not in constant use, the bore should be purged for a minimum of three bore volumes to give a representative sample of source water. The sample tap should be upstream of any treatment or storage facilities.

The timing of the sampling is a very important consideration. With determinands for which preservation is available, it is desirable to minimise the time between sampling and analysis. For determinands that cannot be preserved or measured in the field, a rapid return to the laboratory and minimal delay before analysis may be crucial. Sampling personnel must therefore dispatch samples as soon as possible after sampling, and the analytical laboratory should be contacted before sampling to ensure that the scheduled arrival of the samples will permit urgent analyses to be undertaken. The arrival of samples late on a Friday afternoon may make it impossible for the laboratory to carry out urgent tests.

The timing of sampling also needs to be coordinated with the operation of the treatment plant. Sampling should be carried out when all treatments are in operation. This is especially important with regard to disinfection, which may degrade the chemical quality of the water, eg, sampling when disinfection is offline may result in atypical concentrations of disinfection by-products.

It is necessary to ensure that the results reported for a particular sampling location and date are for the water taken at that time and from that location. The following minimum information should be recorded on the sampling container:

- a) the name and code of the community
- b) the name and code of the source, treatment plant, or distribution zone sampled
- c) date of sampling.

The codes referred to in a) and b) are the Ministry of Health code tabulated in the *Register of Community Drinking-water Supplies in New Zealand*.

### Sampling for metals

When sampling for metals, particularly in plumbing systems, the sample volume needs to be kept small (100–150 mL), and the extent of flushing must suit the purpose for taking the sample.

The small sample volume is necessary to ensure that the sample taken is drawn from the location of interest, and that it is not unduly affected by water from other locations, which may contain different metal concentrations. For example, if information about metal concentrations derived from a tap is needed, this information can be obtained from a small volume of the first flush water. The metal concentration found in a large

sample (eg, 1 litre) may be different from that at the point of interest, because it would contain water from further through the plumbing system where the metal concentration may be different.

The extent of flushing is important for similar reasons. The amount of water drawn from the tap before the sample is taken will influence the location from which the collected water originates: the greater the flushing, the farther away is the actual sampling location. As metals can arise from sampling points, when data on reticulated water quality are required, adequate flushing (usually more than 20 litres) is needed to avoid misleading results. Record the sampling (ie, flushing) technique used.

## Sample sites and containers

It can be important to collect samples from specified parts of the water supply when monitoring P2 determinands. The type of container can be important too. Advice appears in the Appendix to this chapter.

### ii) Correct preservation

For a large number of the determinands referred to in the DWSNZ, some form of preservation is required to avoid changes in their concentration after sampling. Others do not require preservation because they are physically stable, unreactive, or will not undergo microbiological conversion, while others cannot be preserved (eg, pH).

For the latter group, the delay between sampling and analysis must be kept to a minimum. Some substances in this group can be returned to the laboratory, so long as it is done rapidly. For others, although the analytical procedures in the field are less accurate than their laboratory counterparts, the field measurement can provide an approximate result of the determinand concentration before it is able to change. When samples are being transported to the laboratory, deterioration of some samples can be minimised by chilling or freezing; disinfection by-products fall into this class.

Some laboratories may despatch their sampling containers with preservatives already in them. This overcomes the difficulty of having to add a measured quantity of preservative in the field, but care must be taken to ensure that the container is not overflowed, and the preservative lost during sampling.

Preservatives are used to achieve conservation of a determinand's concentration in a number of ways, including:

- inhibition of adsorption of the determinand on the walls of the container. Acid is used to preserve metal samples to avoid this
- inhibition of microbiological conversion of the determinand. Mercuric chloride and acid preservation are used for some determinands to avoid microbiological conversion
- reduction of losses by volatilisation. Samples for ammonia are acidified to form the non-volatile ammonium ion, and samples for cyanide are preserved with caustic soda to avoid the loss of volatile hydrogen cyanide

- quenching reactions producing or removing the determinand. Disinfection by-products will continue to be formed after sample collection, if the disinfectant is not quenched, usually with a reducing agent, such as ascorbic acid, at the time of sampling.

## 10.4.2 Plumbosolvent water

It is assumed in the DWSNZ that all waters are plumbosolvent unless the water supplier can show otherwise. The only sampling the water supplier is required to do, if they wish to demonstrate that their water is not plumbosolvent, is that from a standard plumbing fitting. This option is offered in section 8.3.5 of the DWSNZ. Plumbosolvency is discussed also in sections 10.2.6, 10.3.2 and 10.3.3, as well as in the aggressiveness datasheet in the appendices.

The standard plumbing fitting protocol described in section 10.3.3 is designed to minimise variability in the plumbosolvency assessment by controlling a number of variables that may influence the results:

- The sample volume:** As discussed in section 10.4.1, the volume of the sample can have a strong effect on the concentration of the metal measured in the sample. A maximum sample volume of 150 mL is permitted by the DWSNZ when assessing plumbosolvency. This volume ensures the water collected is only that from the standard plumbing fitting and that there is very little influence from materials beyond the fitting that were in contact with the water.
- The contact time with the standard plumbing fitting:** A minimum contact time of 12 hours is required. This is intended to reflect the typical overnight standing time for water in the plumbing system.
- The composition of the fitting:** The brass selected for the fitting is AS 1567 C38500 alloy. This alloy has a relatively high lead content (ca 2.5–4.5 percent) and has been used in the manufacture of some parts of taps in the past. The standard fitting dimensions have been selected to provide a sample of approximately 140 mL volume that has been in contact with C38500 alloy only.

It is not the intention of the design to reflect the best composition of new taps made from low-lead alloy. The percentage of plumbing fittings in use that are composed of low lead brass will increase with time, but fittings with high lead content are still present. To protect those consumers with high-lead fittings, the plumbosolvency of water is therefore assessed with respect to the ability of the water to dissolve lead from high-lead brass.

Because lead is the corrosion-derived metal of greatest health concern, it is the degree to which lead is leached from the fitting that is used as the measure of the metal dissolving property of the water. To simplify the interpretation of results and reduce analytical costs, no other metals need to be tested using the standard plumbing fitting.



- d) **Flushing before use:** The state of the brass surface used in the standard plumbing fitting will influence the rate at which the metal is dissolved from it, and therefore the concentration of metal in the water. To reduce the variability in the nature of the surface, repeated flushing for a week before using the fitting is required. This can be done by filling the fitting, allowing it to stand for three to four hours, running the water to waste, refilling, and repeating the process. The fitting can be allowed to stand overnight, and should be flushed and refilled in the morning.
- e) **Direct connection to the distribution system:** This eliminates any uncertainties related to the composition and length of service pipe or tubing from the street to the tap, and any doubt about the age of the water if tested in high-rise buildings. Using a distribution system site instead of the water treatment plant will allow any effects from, for example, concrete lining of pipes, to be taken into account; a central site will also be more representative of the water being drunk.
- f) **Interpretation:** The water supply is non-plumbosolvent if the lead concentration in the unflushed sample, less that in the flushed sample, is less than 50 percent of the MAV, in monthly tests over a 12-month period.

Some water supplies may not cause lead to leach from fittings, yet may cause other metals, for example copper, to exceed the MAV due to corrosion of the water service. Section 8.4 of the DWSNZ discusses remedial actions when a MAV is exceeded.

## 10.5 Analytical details

### 10.5.1 Chemical determinands

The use of reliable modern instrumentation for analysis of samples should allow good analytical results to be obtained when samples can be returned to the laboratory for analysis. This should cover most chemical determinands that are required to be tested for chemical compliance. An appropriate analytical technique (see below) and laboratory (see section 10.5.2) are required.

Some comments on the methods of analysis are made in the datasheets. *Standard Methods for the Examination of Water and Wastewater* 22nd edition (APHA 2012) and manuals covering USEPA methods provide details of suitable methods of analysis. In most instances a number of suitable analytical methods for each determinand are provided in *Standard Methods*. The method of choice will depend upon such factors as cost, whether the measurements have to be made in the field, the availability of instrumentation, time lines, other determinands to be measured (multi-determinand methods may be of value), whether the determinand is to be reported as total, soluble etc, and the required sensitivity and accuracy.

Chapter 17: Monitoring Water Treatment and Drinking-water, section 17.2: Sampling; section 17.3: Monitoring for process control; section 17.4: Continuous monitoring for compliance; and section 17.5: Testing, go into this topic in more detail. This section concentrates more on chemical compliance issues. Section 18.6 discusses the analytical details for aesthetic determinands.

The discussion that follows is intended to inform those without analytical training of some aspects of testing that are important, or that are not explicitly noted in method procedures. Rather than discuss each determinand separately, the tests are grouped according to the type of measurement method used.

## Field/treatment plant analyses

There are times when it is necessary for water analyses to be carried out in the field. Chlorine measurement is a good example. The high reactivity of chlorine can result in its concentration changing considerably between sampling and analysis for most waters; field measurements are therefore preferable to laboratory measurement, so long as the field measurements are reliable. Having reliable information on the chlorine residual in a water is very important, and because of this a more detailed discussion on chlorine measurement methods is provided in Chapter 15.

Another example is fluoride and pH. It is possible to measure pH and the fluoride concentration online, and this is often done to control dosage. If the monitoring system is standardised satisfactorily, these process control results can be used for compliance as well.

The detailed procedures for field analyses will be set out either in the analytical reference book from which they are taken, or in the manufacturers' instructions if a commercial test kit or on line method is being used.

Section 3.1.1 of the DWSNZ states that the DWA must assess the competence of the analyst for commonly performed treatment plant or distribution system analyses (field tests).

## The pH test

The pH test is discussed in the chemical chapter because although it is an operational requirement in the DWSNZ, strictly speaking, it is a measure of the concentration of hydrogen ions. There is a datasheet for pH in the aesthetic determinands section.

Standardising the pH meter should be done at at least two pH values. This fixes one pH point and sets the slope. The first standardisation point is at or near pH 7, and the second standardisation point could be near pH 4 or pH 9–10, depending on whether the pH level of the water is typically slightly acidic or alkaline. The third pH buffer should be checked at monthly intervals. Two-point standardisation needs to be carried out daily, or each time if the electrode is not used daily; a standardisation once every week or so is insufficient. Online pH meters should be standardised following the manufacturer's instructions, or as above, whichever is the more frequent. See Appendix A2.5 in the DWSNZ.

Certified buffers can be obtained from laboratory suppliers, otherwise an analytical laboratory accredited for pH testing should be requested to prepare the necessary buffers. Buffer solutions deteriorate as a result of microbial growths so working buffers should be stored appropriately, ie, in the dark in a cool place but not in the refrigerator. Buffers should be dated when received, and should not be used after the expiry date. New buffers should be checked against the old. Details of buffer checks should be recorded.

The electrode must be treated with care and not allowed to dry out. It should be stored in tap water, or preferably a KCl solution. Buffer solutions are quite 'strong' so storing the electrode in a buffer solution can give rise to memory effects when testing water samples. Some electrodes require filling solutions to be replaced regularly. Follow the manufacturer's instructions.

The pH reading from an electrode will not come immediately to the final value and there will be a delay before a reliable reading can be obtained. Although the response of the electrode is rapid in high ionic strength solutions, such as buffers, in natural waters that contain very little dissolved matter, the response is very much slower. Ensure that the buffer has been thoroughly rinsed off the electrode before testing water samples. Meters being used for potable water require special thin glass electrodes to work properly on unbuffered waters. Robust electrodes are not suitable.

The performance of a pH electrode can degrade with age or through lack of maintenance. The drop in performance, unless extreme, is not obvious when using buffers of high ionic strength such as most of the commercial buffers used for electrode standardisation. The effect that this electrode deterioration has on the accuracy of a reading is much more marked in solutions of low ionic strength. Hence, although an electrode may appear to give satisfactory results in the high ionic strength buffers used to check the electrode's standardisation, the pH reading of the electrode in a natural water may be significantly in error. If the time taken for the electrode to equilibrate in a drinking-water sample becomes excessive, the electrode may need attention (see supplier's information sheet) or replacement.

Checks on the performance of an electrode can be performed by using a low ionic strength 'natural water' buffer prepared in the following way: Dissolve  $0.084 \pm 0.001$  g of sodium bicarbonate, and  $0.15 \pm 0.01$  g of potassium bromide in  $1000 \pm 0.5$  mL of distilled water. (Discard as soon as signs of microbiological growth become evident.) This solution needs to be saturated thoroughly with air before it is used to check the electrode performance. This can be done by bubbling air through the solution, or by repeated vigorous shaking with air in a large container, renewing the air between each shaking. At 15°C the pH of this buffer should be between 8.1 and 8.2. The electrode performance is satisfactory if the pH reading from this buffer, after previously standardising the electrode using an acid buffer, lies between 8.0 and 8.3.

### Fluoride: Ion selective electrode (ISE)

Fluoride measurements can be made by electrode, and some larger treatment plants may have them in use online, but because their operation is more complex than a pH probe they are more often used in laboratories.

One of the pitfalls in the use of ISE meters is the unwarranted impression of accuracy they give because of their digital display. The ease with which results can be read from the unit often result in the user thinking that the result from the meter is reliable, and the need for careful standardisation of the instrument is forgotten. The results from an ISE are only reliable if the unit has been properly standardised, and the electrode is in good condition.

Aluminium can interfere with the fluoride analysis; this can be overcome by adding CDTA to the buffer. The electrode must be treated with care and not allowed to dry out. It should be stored in distilled water, or preferably an acidic buffer. Some electrodes require filling solutions to be replaced regularly. Follow the manufacturers' instructions.

## Free available chlorine

### (a) Titration

Free and total available chlorine can be measured in the field by titration using the DPD/FAS titration method (APHA 4500-Cl F) although this is not very practical. APHA 4500-Cl F requires the ferrous ammonium sulphate to be standardised against potassium dichromate. If the ferrous ammonium sulphate has at least a 99 percent assay, the potassium dichromate standardisation step can be omitted. Also, it is possible to purchase a certified chemical solution, eg, 0.10 N, but note that the ferrous ammonium sulphate titrant has a life of only one month once opened. Ferrous ethylenediamine sulphate is also acceptable. See Chapter 18: Aesthetic Considerations, section 18.6, for a more extensive discussion about titrations.

If the amperometric titrator is used for compliance testing, follow the manufacturer's instructions; if they are not explicit regarding standardisation, use APHA 4500-Cl D and/or E which involves preparing and standardising a solution of phenylarsine oxide. The titrator must be standardised at least quarterly.

### (b) Comparator

Free available chlorine (FAC) can be measured using portable equipment such as a comparator or Nessleriser for compliance purposes. This involves visual colour matching so the analyst and equipment must check out satisfactorily against APHA 4500-Cl F or a calibrated portable colorimeter. See Chapter 18: Aesthetic Considerations, section 18.6, for a more extensive discussion.

### (c) Colorimetry

FAC can be measured in the field using a portable spectrophotometer. These instruments should be standardised at least six-monthly using the DPD/FAS titration method (APHA 4500-Cl F), see (a) Titration above. Where an instrument comes with the calibration set by the factory, it should still be sent to an accredited laboratory<sup>4</sup> to determine how the reading of the instrument calibrates against the DPD/FAS method. The portable spectrophotometer must be verified to be within specification using the manufacturer's verification device, at least weekly. If it is outside specification the spectrophotometer is to be returned to the supplier for recalibration.

<sup>4</sup> There are at least three laboratories accredited for this in New Zealand.

Colorimetric methods can also be used for several anions such as nitrite and nitrite, but are usually not sensitive enough for testing metals for compliance with the DWSNZ.

#### (d) Online monitoring

The online FAC monitor must be calibrated against either the portable spectrophotometer or amperometric titrator at least quarterly, or more often if required by the manufacturer. The calibration checks should be carried out at least in duplicate.

## Referee methods

Originally, the column headed Referee Method in Tables A2.1–A2.4 of the 2005/08 DWSNZ were intended to serve as the reference method for that determinand, so that in the event of contention over an analytical result for a particular water, the result obtained by a recognised laboratory using the Referee Method would be considered to be the correct value for the purposes of determining compliance. Alternative methods could have been used for compliance testing if they had been calibrated satisfactorily against the referee method.

Referee methods first appeared in the DWSNZ in 1995 when there were several laboratories testing water samples in New Zealand, not all accredited by IANZ. Infrequent revisions of the DWSNZ mean that the concept of referee methods is too difficult to implement for chemical compliance. The procedure for the approval of new test(s) used for drinking-water sample compliance was altered in December 2010; see <http://www.health.govt.nz/publication/ministry-health-procedure-approval-new-test-methods-bacteriological-compliance-testing-drinking>.

The selection of appropriate test methods is not a function of the DWSNZ, it is part of the laboratory accreditation process. The next DWSNZ will not include referee methods for bacterial compliance testing either.

Chapter 17: Monitoring, Water Treatment and Drinking-water, section 17.5 discusses referee methods, standards and traceability from the laboratory perspective.

## 10.5.2 Laboratory competency

### 10.5.2.1 *The Register of Recognised Laboratories for Drinking-water Supplies*

For the results of monitoring programmes to be reliable, not only must a satisfactory analytical method of measurement be used, but also the laboratory performing the analysis must be competent in the use of the method. A list of water testing laboratories considered qualified to carry out this work is maintained in the Ministry of Health's *Register of Recognised Laboratories for Drinking-water Supplies*. See also Chapter 1: Introduction, section 1.6.14.

See Chapter 17 for more detail.

### 10.5.3 Interpretation of analytical data

The concentration of a determinand in a water sample cannot be measured exactly. Each analytical measurement contains some uncertainty that should be known to the laboratory as the result of its quality control procedures. Refer to Chapter 17 (on Monitoring), section 17.6 for a discussion on how to comparing a test result against a MAV or operational requirement.

## 10.6 Records and assessment of compliance

Section 13 of the DWSNZ lists the information to be recorded in order for a drinking-water supply to be assessed for compliance. The following example illustrates the information to be collected in order to assess compliance for a supply that contains Priority 2 chemical determinands. Comments included to explain the example that do not necessarily have to be provided are written in small italics.

### 10.6.1 Example: Records and assessment of chemical compliance for Bogus community drinking-water supply

Comment: The community of Bogus has two distribution zones, Upperbogus and Lowerbogus. These two distribution zones receive water from the Bogus treatment plant. Lowerbogus is situated in the immediate vicinity of the treatment plant whereas Upperbogus is a small satellite settlement two km from the outskirts of the Lowerbogus distribution zone.

#### Records

Records for the Bogus community drinking-water supply for the period 1 January 2006 to 31 December 2006.

#### Names and codes for supply

Name of the community, distribution zones, plant and sources that the information relates to. This information should be extracted from the Register of Community Drinking-Water Supplies in New Zealand including the register codes. If the supply is not listed in the Register then the Ministry of Health should be contacted to obtain the necessary codes.

|            |          |             |
|------------|----------|-------------|
| Community: | BOG001   | Bogus       |
| Zone:      | BOG001UP | Upperbogus  |
|            | BOG001LO | Lowerbogus  |
| Plant:     | TP00999  | Bogus       |
| Source:    | G01531   | Bogus Bore  |
| Source:    | S01223   | Bogus River |

## Treatment processes in operation at Bogus treatment plant

|                      |  |
|----------------------|--|
| On 1 January 2006    | Coagulation/flocculation using alum, sedimentation, dual media filtration, pH adjustment with lime and chlorination. |
| On 24 April 2006     | Adjusted coagulation pH to improve removal of natural organics.  |
| On 21 September 2006 | Added activated carbon to control taste and odour problems due to algae in river source.                             |
| On 14 December 2006  | Stopped adding activated carbon.   |

## Priority 2 chemical determinands

All Priority 2 chemical determinands identified for Bogus must be monitored according to the Standards for chemical compliance.

Priority 2 chemical determinands for Bogus community water supply published in the *Register of Community Drinking-Water Supplies in New Zealand* (and as notified to the supply manager):

- Upperbogus Distribution Zone (BOG001UP): arsenic, bromodichloromethane
- Lowerbogus Distribution Zone (BOG001LO): arsenic.

## Monitoring programmes, results and actions taken

### Monitoring of arsenic for chemical compliance

Because arsenic is a Priority 2b, Type 1 chemical determinand whose concentration should not change during distribution, it can be monitored in the water leaving the treatment plant or in the distribution zone (Table A3.1 in the DWSNZ). Therefore, the samples for arsenic were collected from the water leaving the treatment plant to prevent having to monitor the Upper- and Lowerbogus distribution zones separately. Samples were collected monthly. The MAV for arsenic is 0.01 mg/L.

| Date sample collected | Sampling site      | Result (mg/L) |
|-----------------------|--------------------|---------------|
| 12 January 2006       | Tap in Bogus plant | 0.007         |
| 17 February 2006      | Tap in Bogus plant | 0.005         |
| 10 March 2006         | Tap in Bogus plant | 0.004         |
| 15 April 2006         | Tap in Bogus plant | 0.003         |
| 12 May 2006           | Tap in Bogus plant | 0.007         |
| 14 June 2006          | Tap in Bogus Plant | 0.006         |
| 13 July 2006          | Tap in Bogus Plant | 0.005         |
| 14 August 2006        | Tap in Bogus Plant | 0.005         |
| 11 September 2006     | Tap in Bogus Plant | 0.004         |
| 13 October 2006       | Tap in Bogus Plant | 0.003         |
| 14 November 2006      | Tap in Bogus Plant | 0.004         |
| 14 December 2006      | Tap in Bogus Plant | 0.005         |

The laboratory that analysed for arsenic was Excellent Laboratory of Bogus, which is on the list of recognised laboratories held by the Ministry of Health. The method used was furnace atomic absorption spectrometry.

The MAV for arsenic was not transgressed, and therefore no corrective action was taken.

### Discretionary monitoring of arsenic

The two sources used for the Bogus supply were monitored for arsenic to determine the source of the arsenic to the supply. The river was found to be the source of the arsenic (0.023 mg/L on 10 March 2006 and 0.027 mg/L on 13 July 2006). On the same dates the bore water contained <0.002 mg/L arsenic. At present the (name of supply authority) is carrying out a feasibility study to see whether it would be possible to rely exclusively, or at least predominantly on the bore source.

### Monitoring of Bromodichloromethane in Upperbogus Distribution Zone for Chemical Compliance

Bromodichloromethane is a Priority 2b, Type 2 chemical determinand that should be sampled from the distribution zone for compliance purposes (Table A3.2b in the DWSNZ). It is a disinfection by-product and the fixed site that has been used to collect samples is located in Stevens Street, a cul-de-sac near at the end of the distribution system. The concentrations of bromodichloromethane are expected to be higher in Stevens Street than near the treatment plant. Samples were sometimes also collected at Matthews Road, in the centre of town and Queen Street, located near the treatment plant, to be able to compare these results with those taken at Stevens Road. Samples have to be collected monthly. The MAV for bromodichloromethane is 0.07 mg/L.



| Date sample collected | Sampling site     | Result (mg/L) |
|-----------------------|-------------------|---------------|
| 12 January 2006       | 27 Stevens Street | 0.043         |
|                       | 14 Matthews Road  | 0.020         |
|                       | 7 Queen Street    | 0.012         |
| 17 February 2006      | 27 Stevens Street | 0.052         |
|                       | 14 Matthews Road  | 0.023         |
|                       | 7 Queen Street    | 0.013         |
| 10 March 2006         | 27 Stevens Street | 0.056         |
| 14 April 2006         | 27 Stevens Street | 0.078         |
|                       | 14 Matthews Road  | 0.029         |
|                       | 7 Queen Street    | 0.018         |
| 20 April 2006         | 27 Stevens Street | 0.080         |
| 27 April 2006         | 27 Stevens Street | 0.020         |
| 3 May 2006            | 27 Stevens Street | 0.022         |
|                       | 14 Matthews Road  | 0.012         |
|                       | 7 Queen Street    | 0.005         |
| 12 May 2006           | 27 Stevens Street | 0.020         |
| 14 June 2006          | 27 Stevens Street | 0.023         |
| 13 July 2006          | 27 Stevens Street | 0.020         |
| 14 August 2006        | 27 Stevens Street | 0.015         |
| 11 September 2006     | 27 Stevens Street | 0.018         |
| 13 October 2006       | 27 Stevens Street | 0.020         |
| 14 November 2006      | 27 Stevens Street | 0.022         |
| 14 December 2006      | 27 Stevens Street | 0.012         |

On 14 April 2006 the sample for bromodichloromethane transgressed its MAV of 0.07 mg/L. This was not the first time the (name of supply authority) has had trouble with bromodichloromethane and confirmed the results which resulted in it being a Priority 2 determinand for Bogus. We increased the monitoring frequency as required in the transgression section (8.4) of the DWSNZ and investigated the options available to us to reduce the level of bromodichloromethane in the Upperbogus distribution zone. In late April 2006 we adjusted the coagulation pH to improve the removal of natural organic matter and subsequent monitoring has shown that this was successful. We continued monitoring at a weekly frequency until we had three clear results and then we returned to monthly monitoring.

## Staff supervisors and operators

Mr J Smith, Bachelor of Civil Engineering

Mr D Brown, B Grade Operators Certificate

Ms E Jones, B Grade Operators Certificate

## Assessment of results

- A The results for arsenic in the Upperbogus and Lowerbogus distribution zones are all less than the MAV for arsenic of 0.01 mg/L. Therefore arsenic complies with the DWSNZ. Some results exceeded 50 percent MAV for arsenic (0.005 mg/L) so arsenic will remain a Priority 2 determinand and it will be necessary to continue to monitor for arsenic in this supply.
- B The concentration of bromodichloromethane exceeded the MAV of 0.07 mg/L in two samples. Corrective action remedied the situation, but for the period of 1 January 2006–31 December 2006, the supply did not comply for bromodichloromethane and therefore failed chemical compliance. The supply will need to continue to be monitored for bromodichloromethane. However, the action taken appears to have resulted in a concentration of bromodichloromethane of less than 50 percent MAV (ie, 0.035 mg/L). If these results continue for 12 successive months then bromodichloromethane can be relegated to Priority 3 by agreement with the public health agency for the Upperbogus distribution zone and will no longer need to be monitored monthly.

## 10.7 Response to transgressions

Refer to Appendix A1.2 in DWSNZ, and to Chapter 17 (on Monitoring), section 17.6 for a discussion on how to compare a test result against a MAV or operational requirement.

Figure 8.1 and section 8.4 of the DWSNZ provide greater flexibility with regard to what remedial actions a water supplier should take in the event of a chemical MAV transgression, than is allowed with respect to the transgression of a microbiological MAV. When a chemical transgression has occurred the water supplier is required to take appropriate action, and to inform the DWA of the cause of the transgression as soon as this is known.

Water suppliers should discuss their intended remedial action, once it has been determined, with the DWA to ensure that it is mutually regarded as being appropriate. A record must be kept of monitoring results, the actions taken and the outcomes of these actions.

The primary reasons for allowing the greater flexibility in dealing with chemical transgressions are:

- 1 chemical MAVs are almost always set to take account of chronic effects, therefore the need for a rapid response, as is required for the appearance of microbial contaminants in the water, does not exist (unless a chemical spill or similar event has resulted in a concentration that may have acute health effects)
- 2 remedial actions required to overcome chemical transgressions may require more time and resources to implement that may often be the case for microbial contamination.

The following factors, and possibly others, will influence the nature of the remedial action considered appropriate under the particular circumstances of each supply:

- a) **The cause of the transgression and the options for improving water quality:** The cause of the transgression must be determined so that possible remedial actions can be identified.
- b) **Timeframes associated with the possible remedial actions:** Once the possible remedial actions have been identified, the action that best meets the needs of the situation should be selected. In making this selection consideration has to be given to the protection of public health, and availability of resources. In judging whether a remedial action is satisfactory, the timeframe for implementation required by the nature of the remedial action needs to be taken into account.
- c) **Availability of resources and cost of possible remedial actions:** When remedial actions can be taken easily these should be implemented as soon as practicable. Improved control over an existing process, as discussed in the previous section, is an example of this type of action. After any necessary assistance has been sought, this action can be taken within a few weeks.

Actions that can be implemented quickly may not, however, achieve an adequate reduction in the determinand of concern. Under these circumstances, major capital expenditure may be required to achieve improved water quality. It is unreasonable to expect this type of remedial action to be implemented in a few weeks; time will be needed to accommodate it within budgets and for construction, or installation, to be carried out.

Remedial actions that will take time to implement can be considered as appropriate if they are introduced into the Improvements Schedule of the WSP.

- d) **Frequency at which transgressions occur:** While remedial actions requiring substantial resources might be considered if transgressions are occurring frequently, it may not be possible to justify them where infrequent transgressions that do not greatly exceed the MAV are encountered. In these cases, discussion between the supplier and the DWA is important so that action that meets public health needs and the resource limitations of the supplier can be identified.

There may be instances in which a MAV is transgressed regularly, but no effective remedial actions are available to the water supplier to reduce the concentration of the determinand in the water supply. Nitrate in groundwater may be an example of this. The source of the nitrate is likely to be linked to present, or past, activities in the catchment, over which the water supplier may have no control. In looking for appropriate remedial action, actions that protect public health without improving the water quality should not be overlooked.

Continuing with the example of nitrate, as bottle-fed infants are the primary concern, the public health risk could be greatly reduced by making certain mothers of newborn infants are made aware of the need to prepare milk from bottled water. Water supplies where nitrate exceeds the short-term MAV will need a process for advising parents of newborn children that they will need to use a different water for a few months if the baby is bottle fed. This information could be disseminated by the water supplier through organisations such as the Plunket Society, maternity hospitals, midwives and doctors. It may need to be sent out at regular intervals. The procedure should be described in the WSP.

Water suppliers' WSPs must also document planned responses to events other than failing to satisfy the criteria in the DWSNZ that will obviously lead to a chemical transgression or non-compliance. These should be rare in New Zealand, and will tend to be supply-specific. The most likely cause will be spills of wastewater or other contaminants upstream of the intake. This will require a good knowledge of the catchment activities and what substances are transported, used or stored upstream.

The USEPA (2008) has developed a manual to provide guidance to water suppliers on identifying TTHM and HAA5 peaks and conducting operational evaluations to determine the cause(s) of and reduce such peaks.

## Appendix: Sampling requirements

These tables were in the 1995, 2000, 2005 and 2008 DWSNZ. They have been transferred to the Guidelines without the Referee Methods. The DWSNZ now state that laboratories can use the test methods for which they have accreditation.

The choice of sample containers is explained in texts such as "Standard Methods ...." (APHA, AWWA, WEF). Laboratories may specify alternative sample containers if appropriate.

The tables in the Appendix indicate which sampling site(s) are appropriate for each determinand. A tick in the distribution zone (DZ) column indicates the sample must be taken from only the distribution zone. Ticks in both the water leaving the treatment plant (TW) and DZ columns indicate the determinands may be sampled from the drinking-water at the treatment plant or in the distribution zone. The sampling location (distribution zone or treatment plant) will be identified when the Priority 2b assignment is made.

Note: Abbreviations used in the tables are explained in Table A10.6

**Table A10.1: Inorganic determinands: sampling requirements**

| Name              | Sampling location |    | Container  |
|-------------------|-------------------|----|------------|
|                   | TW                | DZ |            |
| antimony          |                   | ✓  | P(A), G(A) |
| arsenic           | ✓                 | ✓  | P(A), G(A) |
| barium            | ✓                 | ✓  | P(A), G(A) |
| boron             | ✓                 | ✓  | P          |
| bromate           |                   | ✓  | P          |
| cadmium           |                   | ✓  | P(A), G(A) |
| chlorate          | ✓                 | ✓  | P          |
| chlorine          |                   | ✓  | G          |
| chlorite          |                   | ✓  | P          |
| chromium          |                   | ✓  | P(A), G(A) |
| copper            |                   | ✓  | P(A), G(A) |
| cyanide           | ✓                 | ✓  | P          |
| cyanogen chloride |                   | ✓  | G(S)       |
| fluoride          | ✓                 | ✓  | P          |
| lead              |                   | ✓  | P(A), G(A) |
| manganese         |                   | ✓  | P(A), G(A) |
| mercury           | ✓                 | ✓  | G(A)       |
| molybdenum        | ✓                 | ✓  | P(A), G(A) |
| monochloramine    |                   | ✓  | G          |
| nickel            |                   | ✓  | P(A), G(A) |
| nitrate           |                   | ✓  | P, G       |
| nitrite           |                   | ✓  | P, G       |
| selenium          | ✓                 | ✓  | P(A), G(A) |
| uranium           | ✓                 | ✓  | P(A)       |

**Table A10.2: Cyanotoxins: sampling requirements**

| Name   | Sampling location |    | Container |
|--|-------------------|----|-----------|
|  | TW                | DZ |           |
| anatoxin-a   | ✓                 | ✓  | G(S) P(S) |
| anatoxin-a(S)  | ✓                 | ✓  | G(S) P(S) |
| cylindrospermopsin                                     | ✓                 | ✓  | G(S) P(S) |
| homoanatoxin-a   | ✓                 | ✓  | G(S) P(S) |
| microcystins (expressed as MC-LR toxicity equivalents) | ✓                 | ✓  | G(S) P(S) |
| nodularin  | ✓                 | ✓  | G(S) P(S) |
| saxitoxins (as STX-eq)                                 | ✓                 | ✓  | G(S) P(S) |

**Table A10.3: Organic determinands: sampling requirements**

| Name                           | Sampling location |    | Container |
|--------------------------------|-------------------|----|-----------|
|                                | TW                | DZ |           |
| acrylamide                     | ✓                 | ✓  | G(S)      |
| benzene                        | ✓                 | ✓  | G(S)      |
| benzo[a]pyrene                 |                   | ✓  | G(S)      |
| bromodichloromethane           |                   | ✓  | G(S)      |
| bromoform                      |                   | ✓  | G(S)      |
| carbon tetrachloride           |                   | ✓  | G(S)      |
| chloroform                     |                   | ✓  | G(S)      |
| di(2-ethylhexyl)phthalate      |                   | ✓  | G(S)      |
| dibromoacetonitrile            |                   | ✓  | G(S)      |
| dibromochloromethane           |                   | ✓  | G(S)      |
| dichloroacetic acid            |                   | ✓  | G(S)      |
| dichloroacetonitrile           |                   | ✓  | G(S)      |
| 1,2-dichlorobenzene            |                   | ✓  | G(S)      |
| 1,4-dichlorobenzene            | ✓                 | ✓  | G(S)      |
| 1,2-dichloroethane             |                   | ✓  | G(S)      |
| 1,2-dichloroethene (cis/trans) | ✓                 | ✓  | G(S)      |
| dichloromethane                |                   | ✓  | G(S)      |
| 1,4-dioxane                    | ✓                 | ✓  | G(S)      |
| EDTA                           | ✓                 | ✓  | G(S) P(S) |
| epichlorohydrin                | ✓                 | ✓  | G(S)      |
| ethylbenzene                   | ✓                 | ✓  | G(S)      |
| hexachlorobutadiene            | ✓                 | ✓  | G(S)      |
| monochloroacetic acid          |                   | ✓  | G(S) P(S) |
| nitrilotriacetic acid          | ✓                 | ✓  | G(S)      |
| styrene                        | ✓                 | ✓  | G(S)      |
| tetrachloroethene              |                   | ✓  | G(S)      |
| toluene                        |                   | ✓  | G(S)      |
| trichloroacetic acid           |                   | ✓  | G(S)      |
| trichloroethene                |                   | ✓  | G(S)      |
| 2,4,6-trichlorophenol          |                   | ✓  | G(S)      |
| vinyl chloride                 |                   | ✓  | G(S)      |
| xylenes                        |                   | ✓  | G(S)      |

**Table A10.4: Pesticides: sampling requirements**

| Name                         | Sampling location |    | Container |
|------------------------------|-------------------|----|-----------|
|                              | TW                | DZ |           |
| alachlor                     | ✓                 | ✓  | G         |
| aldicarb                     | ✓                 | ✓  | G         |
| aldrin/dieldrin              | ✓                 | ✓  | G         |
| atrazine                     | ✓                 | ✓  | G         |
| azinphos-methyl              | ✓                 | ✓  | G         |
| bromacil                     | ✓                 | ✓  | G         |
| carbofuran                   | ✓                 | ✓  | G         |
| chlordane                    | ✓                 | ✓  | G         |
| chlorotoluron                | ✓                 | ✓  | G         |
| chlorpyrifos                 | ✓                 | ✓  | G         |
| cyanazine                    | ✓                 | ✓  | G         |
| 2,4-D                        | ✓                 | ✓  | G         |
| 2,4-DB                       | ✓                 | ✓  | G         |
| DDT + isomers                | ✓                 | ✓  | G         |
| 1,2-dibromo-3- chloropropane | ✓                 | ✓  | G         |
| 1,2 dibromoethane            | ✓                 | ✓  | G         |
| 1,2-dichloropropane          | ✓                 | ✓  | G         |
| 1,3-dichloropropene          | ✓                 | ✓  | G         |
| dichlorprop                  | ✓                 | ✓  | G         |
| dimethoate                   | ✓                 | ✓  | G         |
| diuron                       | ✓                 | ✓  | G         |
| endrin                       | ✓                 | ✓  | G         |
| fenoprop                     | ✓                 | ✓  | G         |
| hexazinone                   | ✓                 | ✓  | G         |
| isoproturon                  | ✓                 | ✓  | G         |
| lindane                      | ✓                 | ✓  | G         |
| MCPA                         | ✓                 | ✓  | G         |
| mecoprop                     | ✓                 | ✓  | G         |
| metalaxyl                    | ✓                 | ✓  | G         |
| methoxychlor                 | ✓                 | ✓  | G         |
| metolachlor                  | ✓                 | ✓  | G         |
| metribuzin                   | ✓                 | ✓  | G         |
| molinate                     | ✓                 | ✓  | G         |
| oryxalin                     | ✓                 | ✓  | G         |
| oxadiazon                    | ✓                 | ✓  | G         |
| pendimethalin                | ✓                 | ✓  | G         |
| pentachlorophenol            | ✓                 | ✓  | G         |
| picloram                     | ✓                 | ✓  | G         |

| Name                  | Sampling location |    | Container |
|-----------------------|-------------------|----|-----------|
|                       | TW                | DZ |           |
| pirimiphos methyl     | ✓                 | ✓  | G         |
| primisulphuron methyl | ✓                 | ✓  | G         |
| procymidone           | ✓                 | ✓  | G         |
| propazine             | ✓                 | ✓  | G         |
| pyriproxifen          | ✓                 | ✓  | G         |
| simazine              | ✓                 | ✓  | G         |
| 2,4,5-T               | ✓                 | ✓  | G         |
| terbacil              | ✓                 | ✓  | G         |
| terbuthylazine        | ✓                 | ✓  | G         |
| thiabendazole         | ✓                 | ✓  | G         |
| triclopyr             | ✓                 | ✓  | G         |
| trifluralin           | ✓                 | ✓  | G         |
| 1080                  | ✓                 | ✓  | G         |

**Table A10.5: Radiological determinands: sampling requirements**

Contact Radiochemistry Laboratory, ESR Christchurch.

**Table A10.6: Abbreviations used in Tables A10.1–A10.4**

| Sample sites |                                   |
|--------------|-----------------------------------|
| DZ           | distribution zone                 |
| TW           | water leaving the treatment plant |
| Containers   |                                   |
| (A)          | acid washed                       |
| G            | glass                             |
| P            | plastic                           |
| (S)          | solvent washed                    |



## References

- Aherns M. 2008. *Review of Organic Chemicals of Potential Environmental Concern in Use in Auckland*. Prepared by NIWA for Auckland Regional Council. Auckland Regional Council Technical Report 2008/028. Go to [www.arc.govt.nz](http://www.arc.govt.nz) and select Technical Publications.
- APHA. 2012. *Standard Methods for the Examination of Water and Wastewater* (21st edition). Washington: American Public Health Association, American Water Works Association, Water Environment Federation.
- AS/NZS 4020:2005. *Testing of Products for Use in Contact with Drinking Water*. 8 pp. (Foreword and contents only).  
<https://www.saiglobal.com/PDFTemp/Previews/OSH/as/as4000/4000/4020-2005.pdf>.
- ATSDR (as at October 2015). *Minimal Risk Levels (MRLs)*. Agency for Toxic Substances & Disease Registry (ATSDR). [http://www.atsdr.cdc.gov/mrls/pdfs/atsdr\\_mrls.pdf](http://www.atsdr.cdc.gov/mrls/pdfs/atsdr_mrls.pdf).
- Auckland City. 2016. *An Update on Emerging Organic Contaminants of Concern for New Zealand with Guidance on Monitoring Approaches for Councils. Technical Report 2016/006*. 120 pp. <http://www.aucklandcouncil.govt.nz> go to Plans, policies and projects/Reports/Technical publications and research.
- AWWA. 1990. *Water Quality and Treatment* (4th edition). Published for American Water Works Association by McGraw-Hill Inc.
- AWWA. 1995. *Water Fluoridation Principles and Practices* (4th edition). Manual M4. Denver CO: American Water Works Association.
- Brodlo L, Loxley J, Byleveld P. 2005. Illness associated with consumption of drinking water contaminated by copper corrosion. Presented at AWA Specialty Conference, *Contaminants of Concern in Water*, Canberra, 22–23 June (paper available on CD-ROM from Australian Water Association).
- CDC. 2013. *Fluoridation of Drinking Water and Corrosion of Pipes in Distribution Systems Fact Sheet*. Centers for Disease Control and Prevention, Atlanta GA. 4 pp. <http://www.cdc.gov/fluoridation/factsheets/engineering/corrosion.htm>.
- DEFRA. 2013. *Understanding the Changes in Pesticide Usage to Inform Water Company Risk Assessments*. Project WT 1264. <http://dwi.defra.gov.uk/research/completed-research/2000todate.htm>.
- DWI. 2010, January update. *Blue Water and Copper Pipes*. Information leaflets/FAQs. 2 pp. <http://dwi.defra.gov.uk/consumers/advice-leaflets/index.htm>.
- DWI. 2010a. *The Water Supply (Water Quality) Regulations 2010*. Water, England and Wales. 2010 No. 994 (W.99). 42 pp. <http://dwi.defra.gov.uk/stakeholders/legislation/wsr2010wales.pdf>.
- DWI. 2013. *Potential Contaminants in Drinking Water Treatment Chemicals: Final Report*. Report No. Defra9033.03. 129 pp. <http://dwi.defra.gov.uk/>.

- DWI. 2014. *Brass Fittings: A source of lead in drinking water*. Report Ref No 14/DW/04/14. <http://dwi.defra.gov.uk/research/completed-research/2000today.htm#rachem> or <http://dwi.defra.gov.uk/>.
- DWI. 2014a. *Risks to Drinking Water from Personal Care Products and Domestic Cleaning Products*. WRc Ref: DWI9879.03. Report No: DWI9879.03. 121 pp. <http://dwi.defra.gov.uk/research/completed-research/reports/DWI70-2-283.pdf>.
- DWI. 2015. *Effect of UV on the Chemical Composition of Water including DBP Formation: Final report*. Report No: Defra 10459.04. 137 pp. <http://dwi.defra.gov.uk/research/completed-research/reports/DWI70-2-300.pdf>.
- DWI. 2016. *Brass Fittings as a Source of Lead and Nickel in Drinking Water: Long-term leaching studies*. UKWIR Report Ref No. 15/DW/04/16. 4 pp. <http://dwi.defra.gov.uk/research/completed-research/2000today.htm>.
- EnHealth. 2012. *Environmental Health Risk Assessment: Guidelines for assessing human health risks from environmental hazards* (update). 131 pp. [http://www.health.gov.au/internet/main/publishing.nsf/content/804F8795BABFB1C7CA256F1900045479/\\$File/DoHA-EHRA-120910.pdf](http://www.health.gov.au/internet/main/publishing.nsf/content/804F8795BABFB1C7CA256F1900045479/$File/DoHA-EHRA-120910.pdf).
- EnHealth. 2012a. *The Role of Toxicity Testing in Identifying Toxic Substances in Water: A framework for identification of suspected toxic compounds in water*. Commonwealth of Australia. Australian Health Protection Principal Committee, Canberra. 33 pp. <http://www.health.gov.au/internet/main/publishing.nsf/Content/health-publth-publicat-enviro.htm>.
- Health Canada, Health Protection Branch. 2000. *Review of Contaminant Occurrences in Drinking Water Treatment Chemicals, a Summary Report of NSF International Results (1991 to 1999); ANSI/NSF Standard 60: Drinking Water Treatment Chemicals – Health Effects*. Prepared by: NSF International, Ann Arbor, MI. Copyright Minister of Public Works and Government Services Canada. Available at [http://www.hc-sc.gc.ca/ewh-semt/water-eau/drink-potab/mater/nsf\\_chemicals-chimiques-eng.php](http://www.hc-sc.gc.ca/ewh-semt/water-eau/drink-potab/mater/nsf_chemicals-chimiques-eng.php).
- Health Canada. 2009. *Guidance on Controlling Corrosion in Drinking Water Distribution Systems*. Water, Air and Climate Change Bureau, Healthy Environments and Consumer Safety Branch, Health Canada, Ottawa, Ontario. 92 pp. (Catalogue No. H128-1/09-595E) [http://www.hc-sc.gc.ca/ewh-semt/alt\\_formats/hecs-sesc/pdf/pubs/water-eau/corrosion/corrosion-eng.pdf](http://www.hc-sc.gc.ca/ewh-semt/alt_formats/hecs-sesc/pdf/pubs/water-eau/corrosion/corrosion-eng.pdf).
- IANZ. 2007. *Supplementary Criteria for Accreditation No. 1.2/2.2*. Ministry of Health Register of Water Testing Laboratories. International Accreditation New Zealand, Auckland. Second edition August. See: <http://www.ianz.govt.nz/>.
- IARC Monograph No. 54. International Agency for Research on Cancer. Available at: <http://monographs.iarc.fr/ENG/Classification/index.php>.
- ICS. 2009. *Stockholm Convention on Persistent Organic Pollutants: Mixed result from Geneva Conference*. The International Chemical Secretariat, Göteborg, Sweden. See: <http://www.chemsec.org/news/news-2009/april-june/222-stockholm-convention-on-persistent-organic-pollutants-mixed-result-from-geneva-conference>.
- IPCS. 2004. *IPCS Risk Assessment Terminology*. Geneva: World Health Organization. ISBN 92 4 156267 6. 117 pp.

MAF. 2006. *Agricultural Pesticides in New Zealand*. MAF Technical Paper No. 2006/09. Prepared for MAF Policy by K Muller, A Rahman and TK James.

The New Zealand Ministry of Health's Guides for drinking-water supplies can be accessed as Word documents on the Ministry of Health website: <http://www.health.govt.nz/water> then select publications and Water Safety Plans.

MoH Public Health Risk Management Plan Guide PHRMP Ref. P8.4. *Treatment Processes – Trace Organics Removal*. Wellington: Ministry of Health.

MoH Public Health Risk Management Plan Guide PHRMP Ref. P9. *Treatment Processes – Fluoridation*. Wellington: Ministry of Health.

MoH. *Annual Review of Drinking-water Quality in New Zealand*. Wellington: Ministry of Health.

MoH. 2005. *Drinking-water Standards for New Zealand 2005*. Wellington: Ministry of Health. And the 2008 Revision.

MoH. *Register of Community Drinking-Water Supplies and Suppliers*. Wellington: Ministry of Health.

MoH. *Register of Recognised Laboratories for Drinking-Water Supplies*. Wellington: Ministry of Health.

MoH. 2012. *The Environmental Case Management of Lead-exposed Persons: Guidelines for Public Health Units: Revised 2012*. Wellington: Ministry of Health. 136 pp. <http://www.health.govt.nz/system/files/documents/publications/environmental-case-management-lead-exposed-persons-revised-feb2012.pdf>.

NHMRC. 2004. *Australian Drinking Water Guidelines*. Canberra.

NHMRC, NRMCC. 2011. *Australian Drinking Water Guidelines Paper 6 National Water Quality Management Strategy*. National Health and Medical Research Council, National Resource Management Ministerial Council, Commonwealth of Australia, Canberra. 1244 pp. <http://www.nhmrc.gov.au/guidelines/publications/eh52>.

Nokes C. 1999. *Risk Factors Leading to the Appearance of Corrosion-derived Metals in Drinking Waters*, FW9932. Report to the Ministry of Health.

Nokes C, Davies H. 2000. *Terminal Report for Phase One of the Priority 2 Chemical Determinand Identification Programme for Assessment of Drinking-water Standards, 1995–2000*, FW0080. Report to the Ministry of Health.

North Carolina Cooperative Extension Service. 2014. *Soil Facts. Protecting groundwater in North Carolina*. 6 pp. <http://infohouse.p2ric.org/ref/19/18717.pdf>.

NZWWA. 2014a. *Good Practice Guide Supply of Fluoride for Use in Water Treatment Water New Zealand*. 23 pp. Water New Zealand, Wellington. [www.nzwwa.org.nz](http://www.nzwwa.org.nz).

NZWWA. 2014b. *Code of Practice: Fluoridation of Drinking-Water Supplies in New Zealand*. 33 pp. Water New Zealand, Wellington. [www.nzwwa.org.nz](http://www.nzwwa.org.nz).

Solecki R, et al. 2005. Guidance on setting of acute reference dose (ARfD) for pesticides. *Food and Chemical Toxicology* 43: 1569–93. This guidance can be obtained from the internet at: <http://www.who.int/ipcs/food/jmpr/arfd/en/index.html>.

Turner MED. 1961. *Proceedings of the Society for Water Treatment and Examination* 10: 162.

USEPA. 2008. *Stage 2 Disinfectants and Disinfection Byproducts Rule; Operational Evaluation Guidance Manual*. EPA 815-R-08-018. 180 pp.

[http://www.epa.gov/ogwdw/disinfection/stage2/pdfs/draft\\_guide\\_stage2\\_operational\\_evaluation.pdf](http://www.epa.gov/ogwdw/disinfection/stage2/pdfs/draft_guide_stage2_operational_evaluation.pdf).

USEPA. Accessed 2012. The following link takes readers to a series of *Guides, Tools and Handbooks* addressing issues related to arsenic in drinking-water.

<http://water.epa.gov/lawsregs/rulesregs/sdwa/arsenic/compliance.cfm>.

WHO. 2003. G Howard, J Bartram. *Domestic Water Quantity, Service Level and Health*. WHO/SDE/WSH/3.02.

[http://www.who.int/water\\_sanitation\\_health/diseases/WSH0302.pdf](http://www.who.int/water_sanitation_health/diseases/WSH0302.pdf).

WHO. 2004a. *Guidelines for Drinking-water Quality* (3rd edition). Geneva: World Health Organization. See also the addenda. Available at on internet at:

[http://www.who.int/water\\_sanitation\\_health/dwq/gdwq3/en/](http://www.who.int/water_sanitation_health/dwq/gdwq3/en/).

WHO. 2004b. *Chemical Safety of Drinking-water: Assessing priorities for risk management*. Geneva: World Health Organization. Available at:

[http://www.who.int/water\\_sanitation\\_health/dwq/cmp/en/](http://www.who.int/water_sanitation_health/dwq/cmp/en/).

WHO. 2005. *Nutrients in Drinking-water*. WHO/SDE/WSH/05.09, 210 pp. Health risks from drinking demineralised water. This is available on the internet at

[http://www.who.int/water\\_sanitation\\_health/dwq/nutrientsindw/en/index.html](http://www.who.int/water_sanitation_health/dwq/nutrientsindw/en/index.html).

WHO. 2006. *Health Aspects of Plumbing*. Published jointly by the World Health Organization and the World Plumbing Council. ISBN 92 4 156318 4. Available on the internet at:

[http://www.who.int/water\\_sanitation\\_health/publications/plumbinghealthasp/en/](http://www.who.int/water_sanitation_health/publications/plumbinghealthasp/en/).

WHO. 2006. *Fluoride in Drinking-water*. Geneva: World Health Organization. 144 pp.

[http://www.who.int/water\\_sanitation\\_health/publications/fluoride\\_drinking\\_water\\_full.pdf](http://www.who.int/water_sanitation_health/publications/fluoride_drinking_water_full.pdf).

WHO. 2007. *Chemical Safety of Drinking-water: Assessing priorities for risk management*. Geneva: World Health Organization. 160 pp. Available at:

[http://whqlibdoc.who.int/publications/2007/9789241546768\\_eng.pdf](http://whqlibdoc.who.int/publications/2007/9789241546768_eng.pdf) or

[http://www.who.int/water\\_sanitation\\_health/publications/by\\_date/en/index.html](http://www.who.int/water_sanitation_health/publications/by_date/en/index.html).

WHO. 2011. *Guidelines for Drinking-water Quality* (4th edition). Geneva: World Health Organization. Available at:

[http://www.who.int/water\\_sanitation\\_health/publications/2011/dwq\\_guidelines/en/index.html](http://www.who.int/water_sanitation_health/publications/2011/dwq_guidelines/en/index.html).

WHO. 2011a. *Pharmaceuticals in Drinking-water*. WHO/HSE/WSH/11.05. 49 pp.

[http://www.who.int/water\\_sanitation\\_health/publications/2011/pharmaceuticals/en/index.html](http://www.who.int/water_sanitation_health/publications/2011/pharmaceuticals/en/index.html).

WHO. 2017. *Guidelines for drinking-water quality: fourth edition incorporating the first Addendum*. Geneva: World Health Organization. 631 pp.

[http://www.who.int/water\\_sanitation\\_health/publications/drinking-water-quality-guidelines-4-including-1st-addendum/en/](http://www.who.int/water_sanitation_health/publications/drinking-water-quality-guidelines-4-including-1st-addendum/en/).

WHO. 2017a. *Chemical Mixtures in Source Water and Drinking-water*. Geneva: World Health Organization. Licence: CC BY-NC-SA 3.0 IGO. 104 pp.  
[http://www.who.int/water\\_sanitation\\_health/publications/chemical-mixtures-in-water/en/](http://www.who.int/water_sanitation_health/publications/chemical-mixtures-in-water/en/).

WRF. 2014. *Removal of Volatile Organic Contaminants via Low Profile Aeration Technology*. 58 pp. <http://www.waterrf.org/PublicReportLibrary/4439.pdf>.

WRF. 2015. *Reducing Volatile Disinfection By-Products in Treated Drinking Water Using Aeration Technologies*. Water Research Foundation in conjunction with WERF and USEPA. 146 pp. <http://www.waterrf.org/PublicReportLibrary/4441.pdf>.

WRF. 2015a. *Evidence for Association of Human Bladder Cancer with Chlorination Disinfection By-Products*. Web Report #4530. Water Research Foundation and AWWA. 121 pp. <http://www.waterrf.org/PublicReportLibrary/4530.pdf>.

WRF. 2015b. *Guidelines for the Use of Stainless Steel in the Water and Desalination Industries*. Water Research Foundation, Web Report #4431. 150 pp.  
<http://waterrf.org/PublicReportLibrary/4431.pdf>.

# Chapter 11: Radiological compliance

## Contents

|                          |   |           |
|--------------------------|---|-----------|
| <b>11.1</b>              | <b>Introduction</b>   | <b>2</b>  |
| <b>11.2</b>              | <b>Radiological determinands</b>                              | <b>3</b>  |
| 11.2.1                   | Overview and occurrence of radiochemicals                     | 3         |
| 11.2.2                   | Routes of exposure  | 6         |
| 11.2.3                   | Derivation of radiological MAVs                               | 8         |
| <b>11.3</b>              | <b>Monitoring programme design</b>                            | <b>11</b> |
| <b>11.4</b>              | <b>Sampling procedures and techniques</b>                     | <b>11</b> |
| <b>11.5</b>              | <b>Analytical details</b>                                     | <b>12</b> |
| 11.5.1                   | Total alpha and beta radioactivity measurement                | 12        |
| 11.5.2                   | Radiochemical analysis  | 12        |
| 11.5.3                   | Radon determination   | 12        |
| <b>11.6</b>              | <b>Records and assessment of compliance</b>                   | <b>13</b> |
| <b>11.7</b>              | <b>Response to transgressions</b>                             | <b>13</b> |
| <b>11.8</b>              | <b>Radon removal</b>  | <b>13</b> |
|                          | <b>References</b>   | <b>15</b> |
| <br>                     |   |           |
| <b>List of tables</b>    |   |           |
| Table 11.1:              | The natural radionuclides that may be found in drinking-water | 4         |
| Table 11.2:              | Radioactivity in New Zealand waters                           | 6         |
| Health Canada's Table 3: | Radiological Parameters                                       | 10        |

# 11.1 Introduction

This chapter provides information on the sources and occurrence of the radiological determinands covered by the *Drinking-water Standards for New Zealand 2005, reviewed 2008* (DWSNZ, Ministry of Health), and discusses the current and potential risks of contamination of water supplies.

It explains the methods used to derive the Maximum Acceptable Values (MAVs) for determinands of health significance and provides information on how to apply the DWSNZ to these determinands.

The MAV of a determinand is the maximum concentration of that determinand, which does not result in any significant risk to the health of a 70 kg consumer over a lifetime of consumption of two litres of the water a day.

DWI (2008a) provides a tool for the water supply industry to evaluate the following in the event of a radiological incidence:

- a) the effectiveness of drinking water treatment processes in removing radionuclides
- b) the radiation exposure to operatives working within drinking water treatment works for both routine and infrequent tasks
- c) the prediction of where radionuclides may concentrate within drinking water treatment works and the impact of this on concentrations of radionuclides in waste products.

WQRA (2012) summarised a paper where the authors searched the databases PubMed and Scopus to identify all epidemiological studies dealing with potential health effects of naturally occurring radionuclides in drinking water reported for 1970–2009. Only relevant articles published in English in peer reviewed journals were kept. There were 27 peer-reviewed published reports identified of original epidemiological studies, including studies of uranium, radium and radon. Although there were cases where there appeared to be a relationship between the incidence of cancer and the concentration of radionuclides in the drinking water, the authors concluded that 'the available studies do not clearly demonstrate the health effects of radionuclides at levels naturally occurring in drinking water'. Most of the reviewed studies are affected by methodological limitations which should be remedied in future studies.

Section 6.9 of DWI (2017) covers standards and monitoring requirements in the UK for indicative dose, radon and tritium.

# 11.2 Radiological determinands

## 11.2.1 Overview and occurrence of radiochemicals

Radioactivity in drinking-water is principally derived from two sources:

- the leaching of radionuclides from rocks and soils into water
- the deposition of radionuclides from the atmosphere.

Naturally occurring radionuclides from both these sources account for almost the entire radioactivity present in New Zealand drinking-waters. Health Canada (2009) states that excluding medical exposure, natural sources of radiation are responsible for the large majority of radiation exposure (greater than 98%). Traces of artificial radioactive fallout from above ground nuclear weapons tests (conducted up to 1980) are, or were, detectable in the environment but their contribution to drinking-water radioactivity is negligible. For example, levels of strontium-90 and caesium-137 in the environment have decreased substantially since atmospheric testing of nuclear weapons ceased, and these radionuclides are no longer detectable in drinking-water.

Cosmogenic radionuclides, which are produced naturally by continuous cosmic ray bombardment of gases in the Earth's atmosphere, provide a small additional exposure to radiation. These radionuclides are removed to the Earth and enter surface drinking water supplies by the same processes as for nuclear weapons fallout. The important cosmogenic radionuclides,  $^{14}\text{C}$ , tritium,  $^{22}\text{Na}$ , and  $^7\text{Be}$ , together contribute a total dose to humans of about 15  $\mu\text{Sv}/\text{year}$ .

The naturally occurring radionuclides originate in the Earth's crust where uranium, thorium and potassium are widely distributed and detectable in all soils and rocks.

Uranium and thorium are radioactive, and each decays through a series of radionuclides to stable isotopes of lead, as shown in the decay schemes below.

Uranium is a radioactive heavy metal which occurs commonly in small amounts in all rock, soil and other natural materials. Naturally occurring uranium consists of a mixture of three radioactive isotopes,  $^{234}\text{U}$  (0.006 percent),  $^{235}\text{U}$  (0.72 percent) and  $^{238}\text{U}$  (99.27 percent), which have half-lives of  $2.4 \times 10^5$ ,  $7.0 \times 10^8$  and  $4.5 \times 10^9$  years, respectively. Natural uranium decays mainly through emission of  $\alpha$ -particles. The very long half-life of  $^{238}\text{U}$ , the most abundant isotope, results in a very low decay rate per unit mass of uranium. Because of the high percentage of  $^{238}\text{U}$  and its slow decay rate, naturally occurring uranium is, in fact, one of the least radioactive of the unstable isotopes. Uranium ore deposits are typically found in sandstone formations.

Thorium ores and purified thorium materials contain  $^{232}\text{Th}$ ,  $^{228}\text{Th}$  and varying amounts of their radioactive decay products.  $^{232}\text{Th}$  is an  $\alpha$ -particle emitter with a half-life of  $1.4 \times 10^{10}$  years;  $^{228}\text{Ra}$  (half-life, 5.75 years),  $^{224}\text{Ra}$  (half-life, 3.62 days) and  $^{220}\text{Rn}$  (thoron, an isotope of radon) (half-life, 55.6 seconds) are among its decay products (Stehney et al 1980).  $^{228}\text{Th}$  is an  $\alpha$ -particle emitter with a half-life of 1.9 years.



Recent studies (Seiler and Wiemels 2012) have shown that polonium ( $^{210}\text{Po}$ ) can occur in some groundwaters. It is one of the most toxic substances known because of its intense radioactivity, with 1  $\mu\text{g}$  having the activity of  $1.66 \times 10^8$  Bq.  $^{210}\text{Po}$  has a relatively short half-life of 138.4 days and decays to lead ( $^{206}\text{Pb}$ ) by emitting an alpha particle. It is the last unstable isotope in the  $^{238}\text{U}$  series.  $^{210}\text{Po}$  in groundwater is usually  $<0.03$  Bq/L because it is strongly adsorbed to aquifer materials.

## Uranium series

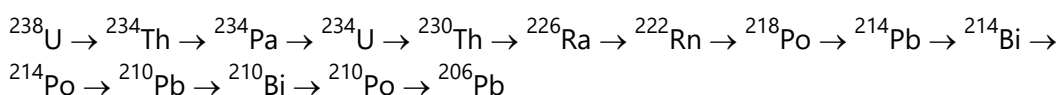

## Thorium series

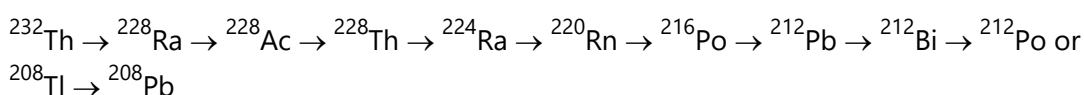

where the symbols represent elements as follows:

Ac, actinium; Bi, bismuth; Pa, protactinium; Pb, lead; Po, polonium; Ra, radium; Rn, radon; Th, thorium; Tl, thallium; U, uranium.

The radionuclides in these decay series display a great range of radioactive half-lives from approximately  $10^{10}$  years for  $^{232}\text{Th}$  to 0.0001 seconds for  $^{214}\text{Po}$ . Every radionuclide emits either alpha or beta radiation but their radiological significance varies. The solubility of thorium, for example, is so low, that it is only found in water as a component of suspended mineral particles. The natural radionuclides primarily regarded as being of radiological interest in drinking water appear in Table 11.1.

**Table 11.1: The natural radionuclides that may be found in drinking-water**

| Radionuclide  | Radiation | Half-life           |
|---------------|-----------|---------------------|
| uranium – 238 | alpha     | $4.5 \times 10^9$ y |
| uranium – 234 | alpha     | $2.5 \times 10^5$ y |
| radium – 226  | alpha     | 1600 y              |
| radium – 228  | beta      | 6.7 y               |
| radon – 222   | alpha*    | 3.8 d               |

\* Radon decay products emit both alpha and beta radiation.

Note that potassium-40 has a half-life of 1.3 billion years.

Only a very small percentage (0.0118 percent) of all potassium is the radioactive isotope potassium-40 ( $^{40}\text{K}$ ). The gross beta measurement includes a contribution from potassium-40, a beta emitter that occurs naturally in a fixed ratio to stable potassium. Potassium is an essential metabolic element for humans and is absorbed mainly from ingested food. Potassium-40 does not accumulate in the body but is maintained at a constant level independent of intake. The contribution of potassium-40 to beta activity should therefore be subtracted following a separate determination of total potassium. The specific activity of potassium-40 is 30.7 Bq/g of potassium. However, not all the

radiation from potassium-40 appears as beta activity. The beta activity of potassium-40 is 27.6 Bq/g of stable potassium (ie, 0.0276 Bq/L per mg of total potassium), which is the factor that should be used to calculate the beta activity due to potassium-40 (WHO 2004).

An example calculation follows:

A bore water sample was found to contain 0.252 Bq/L beta activity. On the face of it, this bore water would become a P2 determinand, being >50 percent of the MAV. But the potassium content was 0.98 mg/L K. Therefore the potassium-40 component was  $0.98 \times 0.0276 = 0.027$  Bq/L, so the activity that is relevant for DWSNZ compliance purposes is  $0.252 - 0.027 = 0.225$  Bq/L, which is less than half the MAV of 0.5 Bq/L, so will not become a P2 determinand.

Note that 18.1 mg/L K will contribute 0.50 Bq/L. There will be just a few bore waters in New Zealand with that much potassium. Bores with 18.2 mg/L K would **appear** to exceed the MAV unless the 'correction' has been made.

The only radionuclides that are actively absorbed in the thyroid gland are the radioiodines. The euthyroid thyroid gland absorbs 20–30 percent of ingested  $^{131}\text{I}$ , but a patient with hyperthyroidism could absorb as much as 60 percent, and none might be absorbed after administration of stable iodine.  $^{131}\text{I}$  is essentially a  $\beta$ -particle emitter, contributing 85 percent of the absorbed tissue dose, while the contribution of  $\gamma$ -radiation is 15 percent. This fact is used in medical practice, where radioiodines have been administered for the last 50 years in the treatment of hyperthyroidism and thyroid cancer. Radioiodines not only locally irradiate the thyroid gland but are also incorporated into thyroid hormones, thus influencing other organs of the body. At present, there is no direct evidence that medical use of  $^{131}\text{I}$  induces thyroid cancers in humans, regardless of the reason for exposure.

Only water supplies from groundwater sources are likely to contain significant concentrations of radionuclides, and the concentrations are as variable as the nature of the soils and rocks themselves.

While groundwaters may contain natural uranium and thorium series radionuclides, surface waters may contain radioactive material deposited from the atmosphere, including both natural radionuclides and materials from artificial sources such as nuclear weapons tests and satellite debris. Although the present levels of contamination from these sources are negligible the DWSNZ apply to radioactivity from all sources, artificial and natural.

Because all radionuclides of interest emit alpha or beta radiation, their levels in drinking-water may be assessed by measurement of the total alpha and beta activities. Such total-activity measurements can be performed rapidly and cost-effectively, and it is only if the total-activity MAVs were exceeded that detailed isotopic analysis would need to be performed. Radon levels are assessed separately because radon is a gas and cannot be analysed in routine alpha activity measurements.

Water supplies in New Zealand servicing population groups of 5000 or more were surveyed for radioactivity levels (Gregory 1980). Samples representing 102 water sources were analysed for total alpha and beta radioactivity and radon concentration, and the results are summarised in Table 11.2.

**Table 11.2: Radioactivity in New Zealand waters**

| Determinand                              | Range Bq/L | Mean Bq/L ± SD |
|--|------------|----------------|
| Total alpha activity, excluding radon    | 0–0.07     | 0.01 ± 0.01    |
| Total beta activity, including potassium | 0–0.3      | 0.05 ± 0.04    |
| Radon concentration: surface waters      | 0–2        | 0.9 ± 1.1      |
| groundwaters                             | 2–54       | 16 ± 11        |

Bq = becquerel

SD = standard deviation

Radon degasses from surface water so concentrations in surface water are expected to be very low. This allows use of radon gas as a natural tracer to study aquifer recharge between rivers and the aquifer system (ESR 2014).

## 11.2.2 Routes of exposure

The human body is, and always has been, exposed to natural background radiation. This ionising irradiation may arise from outside the body, for example from cosmic rays from outer space and  $\gamma$ -rays from the decay of the natural radionuclides of the uranium and thorium series that are present in rocks and other components of the earth's crust.

All human beings are also irradiated by the radiation emitted within organs and tissues by the decay of natural and anthropogenic radionuclides that have entered the body by inhalation or by ingestion of food and drinking-water. This irradiation arises naturally from the decay of the radioactive isotope of the essential element potassium,  $^{40}\text{K}$ , and from uranium and thorium and their radioactive decay products, especially radon. In addition, some individuals or groups may receive whole- or partial-body external radiation from occupational exposure, medical procedures such as X-ray examinations, radiation therapy, from fall-out from atmospheric nuclear weapons testing, or accidents in nuclear facilities resulting in the release into the environment of radionuclides that emit  $\gamma$ -rays.

The passage of ionising radiation through the human or animal body results in the deposition of energy within the irradiated tissue volume. The amount of radiation energy deposited will depend on the length of time over which the individual is irradiated, the strength of the source, the physical half-life of the isotope, and the physical nature of the radiation, eg, X- or  $\gamma$ -rays, cosmic rays,  $\alpha$ -,  $\beta$ - or other particles. Once inside the body, the exposure rate of the radionuclide is maximised, and it will continue to irradiate the body until either the radioactivity has decayed (physical half-lives may vary from fractions of a second to millions of years) or until the substance has been excreted from the body. The rate of excretion, expressed as retention half-time in

the body, may vary from a few days to tens of years, depending primarily on the physical and chemical characteristics and the chemical form of the radionuclide.

$\alpha$ -Radiation is not normally regarded as an external radiation hazard (except perhaps to skin) because it is poorly penetrating, but once  $\alpha$ -particle-emitting radionuclides are in the body they can become a health hazard. However, X- and  $\gamma$ -radiations and neutrons can generally penetrate sensitive organs of the body. As the higher-energy  $\beta$ -radiation can penetrate to about 10 mm into tissue, it can pose both an external hazard and an internal hazard when emissions occur within the body. Unlike exposure to internal radiation, exposure to external radiation can usually be controlled by reducing its duration, increasing the distance from the radiation source and/or using shielding. Radioactive materials may pose an insignificant external hazard, but once they come into contact with or penetrate the body they increase the risk.

Four main routes result in internal exposure to radionuclides: inhalation (eg, radon), ingestion, dermal absorption and direct injection (or through a wound). Radionuclides may be ingested in food and drink, and are absorbed principally from the small intestine, facilitated by its immense surface area of about 200 m<sup>2</sup>.

Ingestion is an important route of entry into the human body since, in addition to those radionuclides present in drinking-water and the diet, a fraction of any inhaled material is swallowed. Some radionuclides such as <sup>3</sup>H, <sup>40</sup>K, <sup>131</sup>I and <sup>137</sup>Cs are almost completely absorbed from the human gastrointestinal tract into the systemic circulation, but the absorption of others is incomplete, from about 30 percent of <sup>90</sup>Sr to <0.05 percent of highly insoluble oxides like <sup>239</sup>PuO<sub>2</sub>.

UNSCEAR (2000) reports that the average natural background radiation dose to human beings worldwide is about 2.4 mSv each year, of which about 1.1 mSv is due to basic background radiation (cosmic rays, terrestrial radiation and ingested radionuclides excluding radon) and 1.3 mSv is due to exposure to radon, but this varies typically over the range 1 to 10 mSv. In any large population about 65 percent would be expected to have effective doses between 1 to 3 mSv, and 25 percent at <1 mSv. However, for a limited number of people living in known high background radiation areas of the world, doses can exceed 20 mSv per year. There is no evidence to indicate this poses a health risk.

For monitoring purposes, doses are determined from the activity concentration of the radionuclide in a given material. In the case of water, activity concentration is given in becquerels per litre (Bq/litre). This value can be related to an effective dose per year (mSv/year) using a dose coefficient (mSv/Bq) and the average annual consumption of water (litres/year), see WHO 2004.

For most people more than half of their natural background radiation dose comes from radon, a radioactive gas that can accumulate in homes, schools and workplaces. When inhaled, the radiation exposure from radon may lead to lung cancer. Radiation doses to humans may be characterised as low-level if they are comparable to natural background levels.

Datasheets for caesium, radium, radon, strontium, thallium, thorium and uranium appear in the inorganic chemicals section.

## 11.2.3 Derivation of radiological MAVs

See Chapter 1: Introduction, section 1.6.2 for a general explanation of maximum acceptable values (MAVs).

All life on earth is exposed to radiation from natural sources including cosmic radiation; external radiation from natural radionuclides present in soils, rocks and building materials; and internal radiation due to potassium-40 and inhaled radionuclides, particularly radon decay products. Natural radiation exposure varies regionally as the compositions of soils and rocks change, and increases with altitude as cosmic radiation intensity increases. Radon is a radioactive gas, which emanates from the ground and can concentrate in buildings. The most important pathway for human exposure is through the permeation of underlying soil gas into buildings (USEPA 2003). Use of water can increase the indoor radon concentration, if radon is present in the water supply.

The risk associated with the presence of radionuclides in drinking-water is an increase in cancer rate. The aim of the DWSNZ is to set limits for radiological determinands, so that the radiation exposure resulting from the presence of radionuclides in water represents only a small part of the total radiation exposure from natural sources.

Radionuclides in drinking-water enter the human body through two pathways leading to radiation exposure:

- 1 internal radiation exposure from ingested radionuclides
- 2 exposure from inhalation of radon gas and its daughter nuclides.

The DWSNZ adopt MAVs that ensure that the committed effective dose from ingested radionuclides is less than 0.1 millisievert per year (5 percent of total average for natural sources). The MAV for radon was chosen to limit the contribution of radon in water to the indoor radon concentration to a level typical for outdoor radon levels (10 Bq/m<sup>3</sup>).

Different radionuclides have a different radio-toxicity and for an accurate determination of the exposure a detailed radioanalytical assessment would be required. However, an upper limit to the exposure can be derived from a measurement of total alpha, total beta and radon concentration.

Dose conversion factors linking concentrations in water to resulting radiation dose, recommended by the International Commission on Radiological Protection (ICRP 1996) were used in deriving the MAV concentrations. This approach is consistent with that of other organisations such as the World Health Organization (2004). The MAVs are deliberately conservative. If the natural radionuclides radium-226 and radium-228 were present in drinking-water at the MAV level (worst case scenario), the annual radiation dose would still be less than 5 percent of the total annual natural dose.

The MAVs for radiological determinands are:

- total alpha concentration: 0.10 becquerel per litre, excluding radon-222
- total beta concentration: 0.50 becquerel per litre, excluding potassium-40
- radon-222 concentration: 100 becquerel per litre.

In the radiological context, the MAV is intended to indicate a level above which the radioactive content of the water should be investigated further and an assessment of all relevant radiological issues undertaken. Radiation protection issues are often complex and many factors would have to be taken into account before a water supply could be classified as unacceptable even though a radiological MAV might have been exceeded. The DWSNZ therefore emphasise that further assessment by the ESR National Centre for Radiation Science is required in such cases. The MAV is thus more of a guideline than necessarily an absolute maximum. It is also intended to be clear however, that at levels below the MAV, there is no need for further assessment.

In 1998, the European Commission issued its Drinking Water Directive. For radionuclides, the Directive gives values for two radiological indicator parameters. These are a concentration of tritium of 100 Bq/L and a total indicative dose (TID) of 0.1 mSv pa; DWI (2013) retains these values. The Directive does not specify the frequency of monitoring that is required, nor the scope of monitoring needed for the estimation of TID. The Directive does specify however that tritium,  $^{40}\text{K}$ , radon and radon decay products should not be included in the estimation of TID.

In England, the Drinking Water Directive (DWD) were implemented by means of the Water Supply (Water Quality) Regulations 2000, published by the Drinking Water Inspectorate (DWI). For radioactivity, these require monitoring for tritium together with measurements of gross alpha and gross beta activity. The criteria that would trigger further investigation such as analysis for specific radionuclides are 0.1 Bq/L for gross alpha and 1 Bq/L for gross beta, which are the values specified by the EC. In the United Kingdom, the main contributors to gross alpha activity are likely to be naturally-occurring radionuclides such as radium-226 ( $^{226}\text{Ra}$ ) and isotopes of uranium. The EC Directive emphasises that the TID refers to a dose received over a full year. Consequently, a single measurement need not necessarily be a cause for concern. It should however be a trigger for further sampling and analysis. See DWI (2008 and 2013) for further details. DWI (2013) states that a parametric value is introduced for radon of 100 Bq/L. However, Member States may set a level higher than 100 Bq/L but lower than 1000 Bq/L which is judged inappropriate to be exceeded. Remedial action must however, be taken where radon concentrations exceed 1000 Bq/L.

Drinking water standards in England and Wales are now set out in European and UK legislation; DWI (2010). They are called Prescribed Concentrations or Values (PCVs) and many are different from WHO's Guideline Values. A screening value of 0.1 Bq/L is set for gross alpha radioactivity, and 1 Bq/L for gross beta radioactivity. They set a total indicative dose for radioactivity of 0.10 mSv/year, and 100 Bq/L for radioactive tritium.

In 2009 Health Canada established maximum acceptable concentrations (in Bq/L) for some individual determinands – see their Table 3 (added below for interest).

Their guidelines for radiological parameters focus on routine operational conditions of existing and new water supplies and do not apply in the event of contamination during an emergency involving a large release of radionuclides into the environment. Maximum acceptable concentrations (MACs) have been established for the most commonly detected natural and artificial radionuclides in Canadian drinking water sources, using internationally accepted equations and principles and based solely on health considerations. The health risk from ingesting radon-contaminated drinking water is considered negligible, because most of the radon escapes at the faucet or

water outlet, leaving only minimal amounts in the water itself. However, it should be noted that radon levels in drinking water, if sufficiently elevated, can significantly affect airborne radon concentrations.

Their MACs are based on exposure solely to a specific radionuclide. The radiological effects of two or more radionuclides in the same drinking water source are considered to be additive. Thus, the sum of the ratios of the observed concentration to the MAC for each contributing radionuclide should not exceed 1. Note that their MAC for total uranium is a chemical MAC (0.02 mg/L), not radiological.

**Health Canada's Table 3: Radiological Parameters**

| Parameter (approval) | MAC (Bq/L)    | Common sources  | Health basis of MAC   | Comments   |
|----------------------|---------------|---|---|--|
| Cesium-137           | 10            | Nuclear weapons fallout and emissions from nuclear reactors                                     | Cancer of the lung, breast, thyroid, bone, digestive organs and skin; leukaemia |  |
| Iodine-131           | 6             | Sewage effluent   | Cancer of the lung, breast, thyroid, bone, digestive organs and skin; leukaemia |  |
| Lead-210             | 0.2           | Naturally occurring (decay product of radon)  | Cancer of the lung, breast, thyroid, bone, digestive organs and skin; leukaemia | Corresponds to total lead concentration of $7 \times 10^{-8}$ µg/L   |
| Radium-226           | 0.5           | Naturally occurring   | Cancer of the lung, breast, thyroid, bone, digestive organs and skin; leukaemia |  |
| Radon                | None required | Naturally occurring (leaching from radium-bearing rocks and soils; decay product of radium-226) | Health risk from ingestion considered negligible due to high volatility         | Mainly a groundwater concern; if concentrations in drinking water exceed 2000 Bq/L actions should be taken to reduce release into indoor air (eg, proper venting of drinking water supply) |
| Strontium-90         | 5             | Nuclear weapons fallout   | Cancer of the lung, breast, thyroid, bone, digestive organs and skin; leukaemia |  |
| Tritium              | 7000          | Naturally occurring (cosmogenic radiation); releases from nuclear reactors                      | Cancer of the lung, breast, thyroid, bone, digestive organs and skin; leukaemia | Not removed by drinking water treatment  |

## 11.3 Monitoring programme design

Natural radioactivity levels in water show seasonal variations, and might change over long periods.

Water from new underground sources should be tested before connection to public supplies, and further testing of bore water supplies that are not considered to be equivalent to surface water is required every 10 years (DWSNZ, section 9.4). Radiological testing of water from other sources is discretionary.

Waters that may present a radiological health concern (from natural causes) are mainly those that have been underground for a long period.

Any water drawn from a confined aquifer is (or could become) secure bore water; in an extreme case – even quite shallow water. These need a radiological check.

Water drawn from unconfined aquifers theoretically could become secure bore water too; but if drawn from less than 10 m the water is considered equivalent to surface water and therefore will not need radiological testing.

Water drawn from bank filtration and infiltration systems is still considered to be surface water and therefore do not require radiological testing.

Regarding bore waters granted interim security – the water supplier is probably hoping that the groundwater will ultimately be granted secure bore water status, so in that case it would be advisable to check out the radiochemical issues before advancing too far into the 12-month interim period.

The same would apply to those waters drawn from underground but which require five years of *E. coli* monitoring etc – even though that water is considered surface water for those five years, the water supplier is presumably hoping that it will ultimately be called secure bore water, so it would be advisable to check out the radiological quality fairly early on.

## 11.4 Sampling procedures and techniques

A drinking-water assessor and/or the ESR National Centre for Radiation Science (in Christchurch) should be contacted before sampling. General guidance follows:

- **Alpha and beta activity:** Generally a one-litre sample of water representative of the source should be collected in a polyethylene bottle. A small quantity of acid should be added as a preservative; approximately 5 mL of 1 M nitric acid is suitable. The sample should be despatched to the analytical laboratory as soon as possible after collection.



- **Radon:** Expert advice should be sought on appropriate sampling techniques. Radon measurements must be performed promptly after collection so it is essential to make prior arrangements with the analytical laboratory.

## 11.5 Analytical details

### 11.5.1 Total alpha and beta radioactivity measurement

Up to DWSNZ 2005, the methods used were:

- United States Environmental Protection Agency. Standard drinking water method for gross alpha by co-precipitation (EPA 520/5-84-006, method 00-02)
- United States Environmental Protection Agency. Environmental Monitoring and Support Laboratory. Prescribed procedures for measurements of radioactivity in drinking water. Gross alpha and gross beta radioactivity in drinking water (Method 900.0, August 1980).

The ESR National Centre for Radiation Science now uses liquid scintillation counting, details available from NRL.

### 11.5.2 Radiochemical analysis

If the total-alpha or total-beta activity MAV is exceeded radiochemical procedures are required for analysis of uranium and radium isotopes and any other radionuclides that may be present. A wide range of techniques may be applied depending on the nature of the sample and the determinand in question. Details of particular techniques may be obtained from the ESR National Centre for Radiation Science.

### 11.5.3 Radon determination

Up to DWSNZ 2005, the method used was:

- radon concentrations in water are determined either by extraction and measurement of the bismuth-214 decay product by beta measurement, or by liquid scintillation counting. Details of particular techniques may be obtained from the National Centre for Radiation Science.

The ESR National Centre for Radiation Science now uses liquid scintillation counting, details available from ESR.

## 11.6 Records and assessment of compliance

Radiological compliance should be assessed by the National Centre for Radiation Science.

Records should be kept for future reference, see section 13 of DWSNZ.

## 11.7 Response to transgressions

If the radioactivity of a drinking-water supply exceeds the MAV, the supply is to be analysed for contributing radioactive materials and an assessment made of their radiological significance by the ESR National Centre for Radiation Science.

If the alpha-radioactivity exceeds the MAV, the water should be analysed for uranium-238, uranium-234 and radium-226.

If the beta-radioactivity exceeds the MAV, the water should be analysed for radium-228 and any artificial radionuclides that may be present.

If the measured levels of these radionuclides do not account for the measured total-activity levels, the water should be analysed for any other radionuclides that may be present such as lead-210 and artificial radionuclides, until a complete assessment can be made.

Remedial action is necessary if the committed effective dose from ingestion exceeds 0.1 mSv/year, or the radon concentration exceeds 100 Bq/L.

The ESR National Centre for Radiation Science will advise on necessary remedial action.

## 11.8 Radon removal

The most effective treatment device to remove radon from drinking-water is a point-of-entry (POE) device. A POE device removes contaminants immediately before they enter the home USEPA (1999). There are two types of point-of-entry devices that remove radon from water:

- granular activated carbon (GAC) filters which use activated carbon to remove the radon
- aeration devices which bubble air through the water and carry radon gas out into the atmosphere through an exhaust fan.

GAC filters tend to cost less than aeration devices; however, radioactivity collects on the filter, which may cause a handling hazard and require special disposal methods for the filter.

The USEPA formulated a proposed Radon in Drinking Water Bill in 1996 and updated it in April 2000 (see References). This reference leads the reader to several other links. The Fact Sheet states:

#### **Best available technology (BAT) for radon in drinking water removal**

High-performance aeration is the proposed BAT for all systems. High-performance aeration is defined as the group of aeration technologies that are capable of being designed for high radon removal efficiencies (up to 99.9 percent removal), ie, packed tower aeration, multi-stage bubble aeration and other suitable diffused bubble aeration technologies, Shallow Tray and other suitable Tray Aeration technologies, and any other aeration technologies that are capable of similar high performance. In addition to listing BAT, which is based on technology evaluations for large systems, the SDWA directs EPA to list small systems compliance technologies (SSCTs): affordable and technically feasible technologies based upon technology evaluations for small systems. EPA is proposing that high performance aeration, granular activated carbon (GAC), and point-of-entry GAC be listed as SSCTs. Issues relevant to safe operation procedures and safe and legal disposal of spent GAC material are addressed in the preamble to the proposed radon rule.

Radon is on the WHO plan of work of the rolling revision of their Guidelines. This is what appears in the draft as at September 2008:

Radon, being a gas, is relatively easy to remove by air stripping. Removal efficiencies of >99 percent were obtained with diffuse bubble and packed tower aeration at air:water ratios of 15:1 and 5:1, respectively (Kinner et al 1990). Other investigations focusing on aeration at public waterworks have given similar results, with 67–99 percent efficiencies (Annamäki and Turtiainen 2000). This is the preferred method of treatment.

GAC is also effective in removing radon from water, with removals of 70–100 percent (Lykins et al 1992). The amount of radon removed by activated carbon is effectively unlimited because the adsorbed radon decays into other radioactive products, such as  $^{210}\text{Pb}$ . As the adsorbed radon decays, radioactive progeny emitting gamma radiation is produced, possibly creating a disposal problem (Castle 1988). Elevated gamma dose rates (up to 120  $\mu\text{Sv/h}$ ) near the filter have been recorded (Annamäki and Turtiainen 2000). Screening of the GAC filter could be required. In some circumstances, a twin tank system, which introduces a time delay that allows the radon to decay to a significant extent, may be a low-cost option.

See Chapter 12: Treatment Processes, Pretreatment, section 12.2.1 for a discussion on aeration treatment systems. A datasheet for radon appears in the inorganic chemicals section.

## References

- Darby S. 2005. Radon in homes and risk of lung cancer: Collaborative analysis of individual data from 13 European case-control studies. *British Medical Journal* 330(7485): 223.
- DWI. 2008. *Requirements for the Radiological Monitoring of Drinking Water: Guidance provided to the Drinking Water Inspectorate*. RPD-EA-9-08. 28 pp. <http://dwi.defra.gov.uk/research/completed-research/reports/EA-9-08radiation.pdf>.
- DWI. 2008a. *Review of Water Treatment Methodologies for Removal of Radionuclides from Drinking Water*. DWI 70/2/192. 79 pp. <http://dwi.defra.gov.uk/research/completed-research/2000today.htm>.
- DWI. 2010. *The Water Supply (Water Quality) Regulations 2010*. Water, England and Wales. No. 994 (W.99). 42 pp. <http://dwi.defra.gov.uk/stakeholders/legislation/wsr2010wales.pdf>.
- DWI. 2013. *New European Requirements for Monitoring for Radioactivity in Drinking Water Supplies*. DWI Information Letter 06/2013. 3 pp. <http://dwi.defra.gov.uk/stakeholders/information-letters/2013/06-2013.pdf>.
- DWI. 2017. *Guidance on the Implementation of the Water Supply (Water Quality) Regulations 2016 in England and the Water Supply (Water Quality) Regulations 2010 (as amended) in Wales*. The Regulations Part 4 – Monitoring of Water Supplies. 21 pp. [http://dwi.defra.gov.uk/stakeholders/guidance-and-codes-of-practice/wswq/04\\_monitoring.pdf](http://dwi.defra.gov.uk/stakeholders/guidance-and-codes-of-practice/wswq/04_monitoring.pdf).
- ESR. 2014. *Analysis of radon data from the Wairau River and adjoining Wairau Plains Aquifer* (February). Author: M Close. 24 pp. Client Report CSC 14001. [http://www.marlborough.govt.nz/Environment/Groundwater/~/\\_media/Files/MDC/Home/Environment/Groundwater/2014%20Reports/ESR%20Radon%20in%20Wairau%20Aquifer%20Recharge\\_Sector\\_Report\\_for\\_MDC\\_23\\_June\\_2014.pdf](http://www.marlborough.govt.nz/Environment/Groundwater/~/_media/Files/MDC/Home/Environment/Groundwater/2014%20Reports/ESR%20Radon%20in%20Wairau%20Aquifer%20Recharge_Sector_Report_for_MDC_23_June_2014.pdf).
- Gregory LP. 1980. *Radioactivity in Potable Waters: Nationwide survey*. National Radiation Laboratory report, NRL 1980/4.
- Health Canada. 2012. *Guidelines for Canadian Drinking Water Quality – Summary table*. <http://www.hc-sc.gc.ca/ewh-semt/water-eau/index-eng.php>.
- Health Canada. 2009. *Guidelines for Canadian Drinking Water Quality: Guideline Technical Document, Radiological Parameters*. 52 pp. <http://www.hc-sc.gc.ca/ewh-semt/water-eau/index-eng.php>.
- IARC. 2000. *IARC Monographs on the Evaluation of Carcinogenic Risks to Humans*. Volume 75: Ionizing Radiation. Part 1: X- and Gamma ( $\gamma$ )-Radiation, and Neutrons. 490 pp. See: <http://monographs.iarc.fr/ENG/Monographs/vol75/index.php>.
- IARC. 2002. *IARC Monographs on the Evaluation of Carcinogenic Risks to Humans*. Volume 78: Ionizing Radiation. Part 2: Some Internally Deposited Radionuclides. 595 pp. See: <http://monographs.iarc.fr/ENG/Monographs/vol78/index.php>.

ICRP. 1996. *Age-dependent Doses to Members of the Public from Intake of Radionuclides: Part 5 Compilation of Ingestion and Inhalation Dose Coefficients*. Publication 72, International Commission on Radiological Protection. Pergamon Press.

Krewski D, et al. 2005. Residential radon and risk of lung cancer: a combined analysis of seven North American case-control studies. *Epidemiology* 16(2): 137–45.

Ministry of Health. 2005. *Drinking-water Standards for New Zealand 2005*. Wellington: Ministry of Health. Revised 2008.

NHMRC, NRMCC. 2011. *Australian Drinking Water Guidelines Paper 6 National Water Quality Management Strategy*. National Health and Medical Research Council, National Resource Management Ministerial Council, Commonwealth of Australia, Canberra. 1244 pp. <http://www.nhmrc.gov.au/guidelines/publications/eh52>.

Seiler RL, JL Wiemels. 2012. Occurrence of  $^{210}\text{Po}$  and biological effects of low-level exposure: the need for research. *Environmental Health Perspectives* 120(9): 1230–37.

UNSCEAR. 2000. *Report to the General Assembly (55th session), with Scientific Annexes*. Volume II: Effects. New York: United Nations Scientific Committee on the Effects of Atomic Radiation. See: <http://www.unscear.org/unscear/index.html>.

USEPA. 1984. *Standard Drinking Water Method for Gross Alpha by Co-precipitation*. EPA 520/5-84-006, method 00-02. United States Environmental Protection Agency.

USEPA. 1980. *Prescribed Procedures for Measurements of Radioactivity in Drinking Water: Gross alpha and gross beta radioactivity in drinking water*. Method 900.0. United States Environmental Protection Agency, Environmental Monitoring and Support Laboratory.

USEPA. 1999. *Radon in Drinking Water: Questions and answers*. EPA 815-F-99-007. 4 pp. Available by entering EPA 815-F-99-007 in Google.

USEPA. 2000. *Proposed Radon in Drinking Water Rule*. EPA 815-F-99-009. Available at: <http://www.epa.gov/safewater/radon/proposal.html>.

USEPA. 2003. *EPA Assessment of Risks from Radon in Homes*. Washington DC: United States Environmental Protection Agency, Office of Radiation and Indoor Air. EPA 402-R-03-003, 99 pp. See: [http://www.epa.gov/radon/risk\\_assessment.html](http://www.epa.gov/radon/risk_assessment.html) or go to [http://www.epa.gov/radon/risk\\_assessment.html](http://www.epa.gov/radon/risk_assessment.html).

WHO. 2004. *Guidelines for Drinking-water Quality 2004* (3rd edition). Geneva: World Health Organization. Available at: [www.who.int/water\\_sanitation\\_health/dwq/gdwq3/en/print.html](http://www.who.int/water_sanitation_health/dwq/gdwq3/en/print.html) see also the addenda.

WHO. 2008. Radon. Rolling revision of the WHO Guidelines for Drinking-water Quality. See [http://www.who.int/water\\_sanitation\\_health/gdwqrevision/radon/en/index.html](http://www.who.int/water_sanitation_health/gdwqrevision/radon/en/index.html).

WHO. 2011. *Guidelines for Drinking-water Quality 2011* (4th edition). Geneva: World Health Organization. Available at: [http://www.who.int/water\\_sanitation\\_health/publications/2011/dwq\\_guidelines/en/index.html](http://www.who.int/water_sanitation_health/publications/2011/dwq_guidelines/en/index.html).

WHO. 2017. *Guidelines for Drinking-water Quality: Fourth edition incorporating the first Addendum*. Geneva: World Health Organization. 631 pp.  
[http://www.who.int/water\\_sanitation\\_health/publications/drinking-water-quality-guidelines-4-including-1st-addendum/en/](http://www.who.int/water_sanitation_health/publications/drinking-water-quality-guidelines-4-including-1st-addendum/en/).

WQRA. 2012 (March issue). Health effects of naturally radioactive water ingestion: The need for enhanced studies. *Environmental Health Perspectives* 119(12): 1676–80.  
<http://www.wqra.com.au>.

# Chapter 12: Treatment processes, pretreatment

## Contents

|              |   |           |
|--------------|---|-----------|
| <b>12.1</b>  | <b>Introduction</b>   | <b>2</b>  |
| <b>12.2</b>  | <b>Groundwater</b>  | <b>3</b>  |
| 12.2.1       | Aeration  | 4         |
| 12.2.2       | Oxidation processes   | 8         |
| 12.2.3       | pH adjustment   | 8         |
| <b>12.3</b>  | <b>Surface water</b>  | <b>9</b>  |
| 12.3.1       | Bank filtration and infiltration galleries                    | 9         |
| 12.3.2       | Off-river storage   | 15        |
| 12.3.3       | Presedimentation  | 18        |
| 12.3.4       | Prefiltration   | 20        |
| 12.3.5       | Microstrainers  | 21        |
| 12.3.6       | Roughing filters  | 22        |
|              | <b>References</b>   | <b>23</b> |
|              | <b>List of tables</b>   |           |
| Table 12.1:  | Reduction times for selected micro-organisms in surface water | 16        |
| Table 12.2:  | Studies of protozoa removal from off-river raw water storage  | 17        |
|              | <b>List of figures</b>  |           |
| Figure 12.1: | Tray aerator  | 6         |

# 12.1 Introduction

Pretreatment of surface water includes processes such as bankside filtration, infiltration galleries, presedimentation, off-river storage, roughing filters, screens and microstrainers. Many pretreatment processes are natural processes, enhanced by design to improve water quality. Pretreatment options may be compatible with a variety of water treatment processes ranging in complexity from simple disinfection to membrane processes. Pretreatment is used to reduce, and/or to stabilise variations in the microbial, natural organic matter and particulate load.

The main pretreatment process for groundwater discussed in this chapter is aeration. Other factors that affect groundwater quality are discussed in Chapter 3: Source Waters, section 3.2. Down-hole maintenance of screens and pipes is also discussed in Chapter 3.

This chapter covers bankside filtration and the other pretreatment processes that do not qualify for protozoal log credits.

Management of the catchment in order to enhance raw water quality is discussed in Chapter 3: Source Waters.

The treatment processes that do qualify are discussed in the water treatment chapters: coagulation (Chapter 13), filtration (Chapter 14), and disinfection (Chapter 15).

Roof water is discussed in Chapter 19.

The 2008 DWSNZ include a new section, section 5.17: Alternative processes: treatment compliance criteria, whereby water suppliers may apply to the Ministry of Health to have other treatment processes assessed for a log credit rating. This approach, which is explained more fully in section 8.4.5 of the Guidelines, allows water suppliers to apply for a log credit rating (or a variation to the prescribed log credits) for a treatment plant or process:

- a) not covered in sections 5.1–5.16 of the DWSNZ
- b) that performs demonstrably better than its compliance criteria
- c) that performs to a lesser, but reliable, level than specified in its compliance criteria.

In theory, it could be possible that a pretreatment process discussed in this chapter could be modified or operated in such a manner that it qualifies for log credits.

Risk management issues related to pretreatment processes are discussed in the:

- MoH Public Health Risk Management Plan Guide PHRMP Ref. 1.1: Surface Water Abstraction – Rivers, Streams and Infiltration Galleries.
- MoH Public Health Risk Management Plan Guide PHRMP Ref. P3: Treatment Processes – Pre-Treatment Storage.
- MoH Public Health Risk Management Plan Guide PHRMP Ref. P4.3: Pre-oxidation.



## 12.2 Groundwater

For bacterial and protozoal compliance purposes, the DWSNZ (section 4.5) distinguish between secure and non-secure bore waters, with shallow non-secure bore waters (which includes springs) being considered equivalent to surface waters. Except where discussing compliance issues, the Guidelines consider groundwater to include all water extracted from under the ground.

Springs flow out of the ground at the surface but may contain water that has been underground for a very short time or distance. However, the types of pretreatment commonly applied to springs means that in this section of the Guidelines, springs are considered equivalent to groundwater.

When surface water enters the ground, changes in its quality occur relatively slowly. For this reason, groundwater sources have a more consistent quality than surface waters. Most bore water pumps have a fixed output so even the flow rate does not change.

When surface water goes underground, it usually carries organic material with it from the top soil and ground cover. This material decays over time, adding to the carbon dioxide content; dissolved oxygen is consumed in the process. This is not toxic or even distasteful, lemonade contains very high levels of CO<sub>2</sub>! The problem with carbon dioxide is that it reacts with the water to form carbonic acid, lowering the pH of the water. If this falls to below 7 (as a guide), the following problems may occur:

- the water will dissolve iron and manganese and, potentially, other metals from the ground itself. These metals stay in solution as long as the pH and dissolved oxygen concentration is low; higher pH levels will normally see them precipitate out as unsightly red, brown or black slimes, flocs or encrustations. This pH lift occurs at a tap when the pressure is released and the carbon dioxide comes out of solution and is replaced by dissolved oxygen
- metallic fittings, particularly copper, zinc (from brass and from galvanised steel), and iron will be corroded. This may affect people's health, especially in the case of copper which has often been measured at concentrations well above its MAV (see datasheet), as well as causing bitter tastes and staining of clothing, basins, baths and pans. For discussion on corrosion of plumbing materials, refer to Chapter 10: Chemical Compliance, section 10.3.4
- concrete and other lime-based materials such as plaster pipe linings and asbestos cement pipes will dissolve, causing the pH of water sitting in the pipes to rise, even to above pH 10. This dissolution can result in detritus (loose sand etc) and the loss of corrosion-prevention linings.

Refer to Chapter 3: Source Waters, section 3.2 for a detailed discussion on groundwater. This includes the development of the well, screens, corrosion, and the deposition of iron and manganese.

## 12.2.1 Aeration

Aeration is a physical process aimed at:

- increasing the dissolved oxygen of the water; and/or
- decreasing the dissolved carbon dioxide content
- assisting in the removal of iron and manganese
- removing other volatile matter such as radon, methane, hydrogen sulphide and taste and odour causing compounds. WRF (2014) summarised a study that determined the effectiveness of tray aeration technology for removing 13 focus carcinogenic volatile organic compounds (VOCs) to the sub  $\mu\text{g/L}$  concentration range. The VOCs' removal efficiencies were studied by collecting operational data from pilot plant operations, under various air-to-water ratios (53–652), three different temperatures (4, 12, and 20°C), and 1 to 6 trays in series. Further information is included in the individual datasheets.

Note that although aeration is discussed in this groundwater sub-section, some surface waters may require aeration too.

The first objective is more common in wastewater treatment, where oxygen is required for bacterial respiration. The second is more common in groundwaters used for drinking. The aeration process removes the gas by jostling it out of solution and sending it to the surface.

Normally, surface water such as stream or river water already has a high dissolved oxygen and low dissolved carbon dioxide content. However, this is not usually the case with groundwater.

The simplest test for whether there is a high carbon dioxide content is to measure the pH, then aerate the water (by, for example, shaking a half-full sample bottle) and re-measure the pH. If it increases by one pH unit or so, you can be confident the water has enough carbon dioxide in it to merit aeration. See Sinton (1986) and Sundaram et al (2009) for advice on sampling groundwater.

The laboratory method for analysing carbon dioxide is described in *Standard Methods* (APHA et al 2005). Care is needed when collecting a sample for carbon dioxide analysis; the procedure is described in Chapter 4: Selection of Water Source and Treatment, section 4.4.1.

Some underground waters contain other dissolved gases such as ammonia and/or hydrogen sulphide, or even methane. These will have marked effects on the aesthetics of the water, in both taste and odour. They also can be reduced by aeration, but may be more difficult to treat than carbon dioxide. Laboratory testing is needed to verify their presence, although in the case of  $\text{H}_2\text{S}$ , it may be easier to detect by smell.

To aerate water, it needs to be split into a thin film or tiny droplets to maximise its exposure to the air. This can be done a number of ways:

**Tray aerators** consist of a series of, usually, four or five horizontal trays that are perforated with small holes at regular intervals. The trays are mounted one above the other, about 150–200 mm apart. The water is dropped on to the top tray, splashes over it, and goes down through the holes on to the next tray, where the same thing happens. Tray aerators are also called low profile air strippers; their design is discussed in WRF (2014).

The tray area needed is calculated by dividing the flow by the loading rate. The loading rate is between 30 and 70 m<sup>3</sup>/h per m<sup>2</sup> of tray area. For example, for a flow of 150 m<sup>3</sup>/h and trays with a loading rate of 50 m<sup>3</sup>/h per m<sup>2</sup>:

- you would need 150 divided by 50 = 3 m<sup>2</sup> of tray area
- five trays works best, so they need to be 3 m<sup>2</sup> divided by 5 = 0.6 m<sup>2</sup> each.

So you would have five trays, one above the other, with each tray, say 1 m by 0.6 m. When in doubt, use extra area, it will do no harm if they are bigger than necessary.

The trays can be made of plastic (uPVC, ABS or polypropylene), stainless steel or hardwood timber. Treated timber must not be used because it will leach copper, chrome or arsenic, or other treatment chemicals.

The holes are typically 10–12 mm in diameter, about 25–40 mm apart. A good working tray aerator can be made from the plastic crates used to carry bread. If they have too many holes (so that the water does not spread out), a sprinkling of coarse gravel will help disperse the flow over the whole area.

Tray aerators need a good air flow to provide oxygen and to remove carbon dioxide. They should have screens to keep mosquitoes or other insects away, and be shaded to limit algal growth. Shade cloth is simple and cheap.

Some tray aerators will precipitate very fine iron or manganese on to the trays. This will need to be hosed off at regular intervals, usually, at least weekly.

Examples of tray aerators can be found at Hannah's Clearing (Westland), Waitane Meats (Gore) and Pleasant Point. The latter, shown in Figure 12.1, is made from bread crates.

**Figure 12.1: Tray aerator**



**Cascade aerators** are similar to tray aerators, but the trays are displaced to form steps. This horizontal offset may appeal architecturally and does enable easier cleaning, but it requires a collection system (along a line or at a point) for the water to be redistributed on to the next tray. This is not needed in tray aerators.

The design loading and performance of cascade aerators are very similar to those of tray aerators. Like tray aerators, they need good ventilation and shade, and regular removal of precipitates if iron and/or manganese are present.

No cascade aerators are in use in New Zealand.

**Spray aerators** use jets to spray the water up into the air. The finer the droplets formed, the more aeration is achieved and, consequently, the greater the carbon dioxide reduction. Spray aerators use more electric power (to produce the hydraulic head) than tray aerators and are less common, partly for this reason. Like tray aerators, the jets need to be ventilated, shaded and screened.

Spray aerators need about 15–20 metres pressure head to produce velocities in the order of 8–10 m/s. With typical loading rates in the order of 10 m/h for a single layer, spray aerators occupy about 25 times as much area as tray aerators.

A design constraint is the need to have multiple jets that do not interfere with each other. There are special nozzles that reduce the jet angle, but they are expensive.

A New Zealand example of a spray aerator was at the Bulls Water Treatment Plant (Rangitikei District Council) but these have been replaced with tray aerators.

**Entrained air** aerators disperse air through the water to allow the transfer of gas from the water into the air, or vice versa. However, they are rarely used, because the energy cost of running a compressor is usually much higher than that of pumping the water.

**Packed tower** aerators are towers through which the water flows down against a current of air blown from a compressor. The towers are filled with surface contactors, a little like the plastic media used for wastewater treatment, to increase the contact area between the water and the air. These contactors are not there for microbiological reasons; they are there solely to increase the contact area. They may be made of plastic, wood or loose media. The main design parameters for packed towers are the specific surface area provided by the media, column diameter, column height, and water and air flow rates.

Packed tower aerators are often called aerators for removing gas and air stripping towers for removing volatile carbon compounds. They can achieve good results in removing or oxidising gases such as methane, ammonia and hydrogen sulphide but are not common in New Zealand.

## Removal rates

All aerators typically remove only about 50 percent of the dissolved gases. Some may reach nearly 75 percent, but none will remove all of it. The remaining carbon dioxide is usually neutralised with an alkali, such as hydrated lime or sodium hydroxide (caustic soda), forming bicarbonate and lifting the pH back to non-aggressive levels, see section 12.2.3.

## Cleaning

If not much iron or manganese is being precipitated, aerators may need to be hosed down only every few months or so. However, high precipitation rates may necessitate cleaning several times a week. Insect screens and air inlets also need to be cleaned from time to time.

## Filtration

After aeration, filtration may be needed to remove further iron and manganese. If so, the carbon dioxide should be neutralised before the water is filtered. The filters should be fine sand (say, 18/36 grade) and be of the normal rapid sand filter design. See Chapter 18: Aesthetic Considerations, section 18.3 for a discussion on iron and manganese removal.

Air stripping and aeration are discussed in Chapter 5 of AWWA (1990). Chapter 2 of USEPA (2004) is the ETV Testing Plan for Volatile Organic Compound (VOC) Removal by Air Stripping Technology for use as a guide in the development of the Product-Specific Test Plan for testing of air stripping equipment, within the structure provided by the ETV Protocol document for VOC removal.

## 12.2.2 Oxidation processes

Aeration is the most common process for removing gases such as carbon dioxide and occasionally methane and H<sub>2</sub>S. Aeration is also used to help in precipitating dissolved iron and manganese. Sometimes the direct addition of an oxidising chemical may be needed to help precipitate the metals and maybe oxidise gases such as ammonia.

The following oxidising chemicals are in common use:

- chlorine, in any form. For example, chlorine will oxidise ferrous iron to ferric iron, making it insoluble so that it precipitates out; it will also oxidise sulphide
- potassium permanganate, also known as Condy's crystals. This is effective at destroying some organic substances and oxidising any manganese bound on to them. Again, the manganese is rendered insoluble and precipitates out. It is not used very often in New Zealand
- ozone, apart from being used as a disinfectant, is sometimes used to oxidise taste and odour compounds because many of these compounds are very resistant to oxidation, but is also used to oxidise iron and manganese, and ammonia, which breaks down to nitrogen and water. It is reported to be used on one groundwater source near Wanganui to reduce the ammonia content. Overseas it may be used to break down pesticide molecules.

Solutions and liquid chemicals are usually added by dose pump into carry water which is then dispersed into the main flow. In smaller supplies, the carry water may be the main pipe. If the chemical is a gas (gas chlorine and ozone), it is always added to carry water, separate from the main supply.

There is often a feedback control loop that adjusts the dose rate to respond to variations in the raw water. The effect is measured in one of three ways: residual chlorine level, pH or ORP (oxidation/reduction potential).

Oxidation processes are discussed in Chapter 12 of AWWA (1990).

See Chapter 18: Aesthetic Considerations, section 18.3 for a discussion on removal of aesthetic determinands.

## 12.2.3 pH adjustment

As mentioned in section 12.2.1, carbon dioxide (CO<sub>2</sub>) can also be removed from water by dosing it with hydrated lime or sodium hydroxide (caustic soda). Aeration is generally the cheaper option, but chemical dosage may be attractive if it avoids breaking the pressure.

The CO<sub>2</sub> concentration needs to be measured, see Chapter 10, section 10.3.4. When collecting a sample for analysis of CO<sub>2</sub>, great care is needed to ensure that the water is not aerated. This can be done by attaching a plastic tube to the tap and inserting the other end to the bottom of the sample bottle, and displacing several volumes before replacing the lid on the sample bottle.

The required dose of lime or sodium hydroxide can be calculated from:

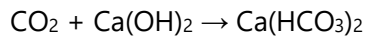
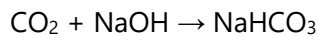

Smaller systems can pass the water through a bed of limestone or dolomite. Akdolite, a propriety product made by heat-treating dolomite, has been used in New Zealand.

## 12.3 Surface water

In this chapter, non-secure bore water and springs are covered in section 12.2.

The pretreatment processes for surface water described below aim to improve the quality of the raw water prior to the main treatment process. Many of them seek to reduce the natural variations or extremes in water quality. A typical case is turbidity (measured as NTU), used to indicate how much mud (or similar) is suspended in the water during heavy rainfall and its run-off. Rivers may reach levels of several hundred NTU during such events, tending to overwhelm the filtration processes by the sheer volume of the solids to be removed.

Pretreatment processes may reduce the level of these solids by factors of ten or more, allowing a treatment plant to continue functioning rather than shutting down or damaging any treatment components, increasing chemical dose rates, or producing substandard water.

Watershed control is not discussed in this chapter. Section 8.4.1.4 of Chapter 8: Protozoal Compliance explains why the 0.5 log credit allowed by the LT2ESWTR (USEPA 2006) is not included in the DWSNZ. New Zealand water suppliers are expected to monitor catchment activities and do what they can to maintain, or preferably enhance, the quality of their source water. This is partly covered in the WSP process, enabled by the National Environmental Standards (Chapter 3, section 3.4.2), and discussed more fully in Chapter 3, section 3.5, and in Chapter 4, section 4.3. Source water is assessed in Part 1 of the grading process.

### 12.3.1 Bank filtration and infiltration galleries

This section covers issues related to the design, operation and maintenance of bank filtration. For discussion on protozoal compliance issues, refer to Chapter 8: Protozoa Compliance.

Experience has shown that both bank filtration and full infiltration galleries can be effective at reducing the concentration of suspended material from surface water that percolates down to the collection area. In some cases the turbidity can be quite low, and consistently so, despite peaks of turbidity in the surface water. Some protozoal (oo)cysts are removed too, which is why the bank filtration process can qualify for protozoal log credits. The consistently lower turbidity can mean that less expensive

treatment such as cartridge or diatomaceous earth filtration can be used instead of chemical coagulation in order to achieve protozoal compliance.

Bank filtration is the process of using vertical or horizontal wells beside rivers and/or lakes. The idea is to use naturally occurring sands to filter the water as it flows through to the gathering well or gallery. To gain protozoa removal credits for this process, the amount of sand present needs to be significant, see section 5.3 of the DWSNZ, which was based on the LT2ESWTR (USEPA 2006). The evidence that the USEPA accepted that showed bank filtration was effective was, in turn, gained from experience of filtering River Rhine water through stop banks and the underlying material.

Pang (2009) reported findings from a study of microbial removal in a range of substrates; higher rates were found in volcanic soils, pumice sand, fine sand, and highly weathered aquifer rocks. Low removal rates were found in structured clayey soils, stony soils, coarse gravel aquifers, fractured rocks, and karst limestone. Microbial removal rates were inversely correlated with infiltration rates and transport velocity.

Sprenger et al (2014) reported that a highly polluted river water in India achieved a virus removal rate of more than a million-fold (>6 log) when the water passed through sands for 50 m in 119 days.

There are several bank filtration schemes in Germany. Typically, they have:

- continuous river flow, stable river banks
- sand and gravel river bed, bed erosion
- sand and gravel aquifers with a hydraulic conductivity higher than  $1 \times 10^{-4}$  m/s
- aquifer thickness between 3 and 70 m, average 20 m
- average infiltration rates  $< 0.2 \text{ m}^3/(\text{m}^2 \text{ day})$
- distance between wells and riverbank mostly  $> 50$  m
- travel time mostly between 25 and 300 days
- mostly vertical wells, a few sites with horizontal wells
- water abstraction capacities between 20 and 600,000  $\text{m}^3/\text{d}$
- proportion of bank filtrate in the pumped raw water more than 50 percent at most sites.

All sites have their own peculiar restrictions, and advantages. Whilst some simplistic diagrammatic examples are shown below, the well or gallery needs to be designed or proven for each location. Few streams and rivers are sited in alluvial sands alone, there will be flow-blocking material such as silts, clays and bedrock ledges. Many New Zealand river beds are largely made up of boulders, which will not offer much treatment. These factors will control where the water may be taken from.

The WSP should allow for the risks at each particular site. Risks may include:

- flood damage to the structures
- floods flowing over the site and inundating the (originally clean) water
- flow levels dropping to such an extent that there is inadequate water available to take.



There will be other risks peculiar to each site.

Some examples of bank filtration and infiltration galleries are as follows.

## Vertical wells

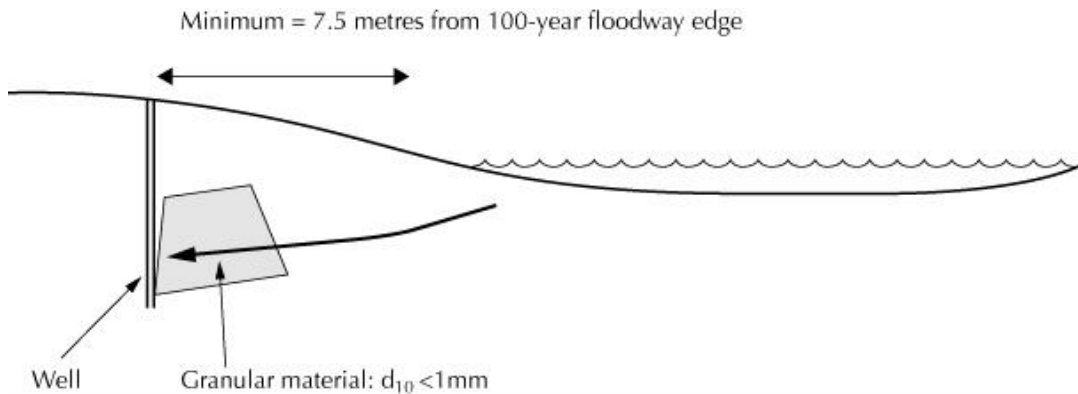

An example of this type of intake is the Taieri bores in Outram, near Dunedin.

In some cases, particularly after local wet weather, groundwater may flow towards the river, so the water collected may be from adjacent surface land, not the river.

The granular material must have a  $d_{10}$  of 1 mm or less. The  $d_{10}$  is the size that 10 percent of the material is smaller than; likewise,  $d_{60}$  is the size that 60 percent is smaller than. A grade of sand ranging between 0.6 mm and 1.2 mm would probably have a  $d_{10}$  of about 0.66 mm and a  $d_{60}$  of about 0.96.

Within a given range, the relative amounts of different-sized grains can vary and the effectiveness of the filter is determined by the fineness of the material overall. This is expressed as the ratio of the  $d_{60}$  to the  $d_{10}$ , or uniformity coefficient (UC). The UC of the sand described above would be 0.96 divided by 0.66 = 1.45. Good filters usually have a UC of 1.5 or lower.

Vertical wells may use a central screen surrounded by a filter pack. The shaft is dug to a much greater diameter than that of the screen, say 1.1 m for a 200 mm screen, and a temporary liner such as a large steel pipe (for this example, about 1 m in diameter) inserted to stop the surrounding material collapsing. The screen is put in place, the filter material inserted in the gap and the liner removed. This technique enables a good thickness of filter material but is more suited to shallower wells of up to 15 m deep; any deeper and it becomes very difficult to remove the liner.

Normally, in deep wells, the screen is placed directly against the country of the aquifer. Following this, the well is usually surged to pull small sand through the screen, this process is called well development.

It is important that the design prevents dirty water flowing down the sides of the shaft, polluting the cleaner water below. This would be one of the risks addressed by the WSP.

## Horizontal wells

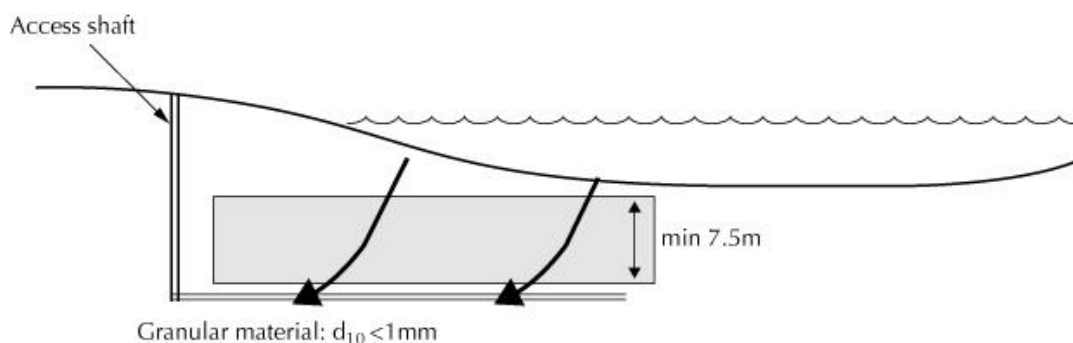

The protozoal log removal credits allowed for bank filtration systems in the DWSNZ are based on data analysis carried out by the USEPA (2003a) and finalised in USEPA (2006). For such a system to qualify for 0.5 log removal of *Cryptosporidium* oocysts, it is required that:

- 1 A horizontal or vertical well is used.
- 2 The ground is unconsolidated gravels or sands that either have a  $d_{10}$  of  $< 1$  mm or can be demonstrated to be an effective filter.
- 3 The groundwater flow path is at least 7.5 metres long. For vertical wells, this distance is measured from the 100-year flood edge to the well; for horizontal wells, it is measured from the river edge and bed under normal flows to the nearest point of the gallery.
- 4 Turbidity measurements are taken at least four-hourly. These must show an average daily maximum of less than 1 NTU, unless a satisfactory explanation is given for non-compliance.

To qualify for 1 log removal credit, the groundwater flow path must be at least 15 m.

In New Zealand some **infiltration galleries** differ from these bank filtration arrangements. The usual method of constructing these galleries is:

- a horizontal trench is excavated, parallel to the river
- a slotted pipe is laid, usually bedded in a filter pack of carefully graded gravel
- the trench is backfilled, usually with the excavated gravels
- the supply is withdrawn from all of the slotted pipe length.

Many of these galleries do not comply with the criteria for bankside filtration.

## Non-complying infiltration gallery

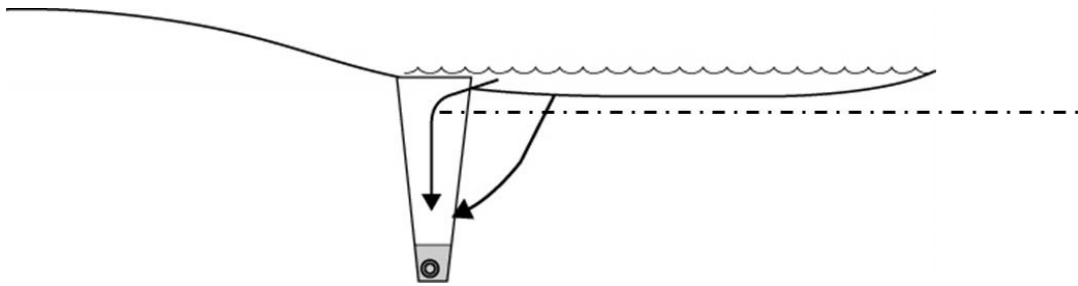

The features that make this non-compliant are:

- the length of the filter path is too short
- the backfill/surrounding material may be too coarse.

## Compliant infiltration gallery (a)

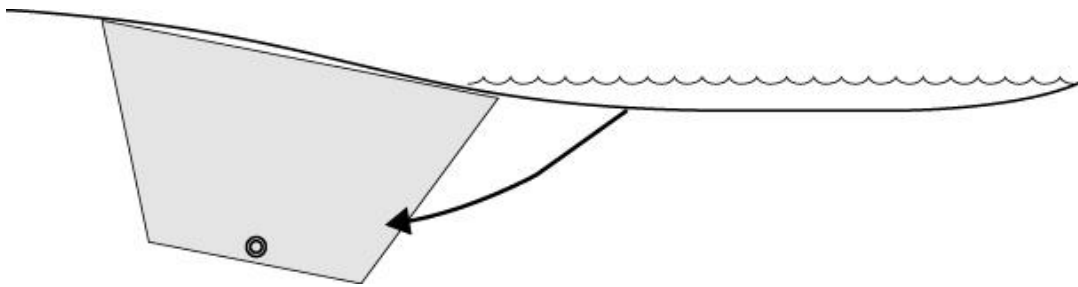

This arrangement complies with the requirements of the DWSNZ, provided the distance is greater than 7.5 m for 0.5 log credit, or 15 m for 1 log credit, and the material has a  $d_{10}$  of  $<1$  mm.

An example of this type of gallery can be found on the Opihi River, Timaru City.

## Compliant infiltration gallery (b)

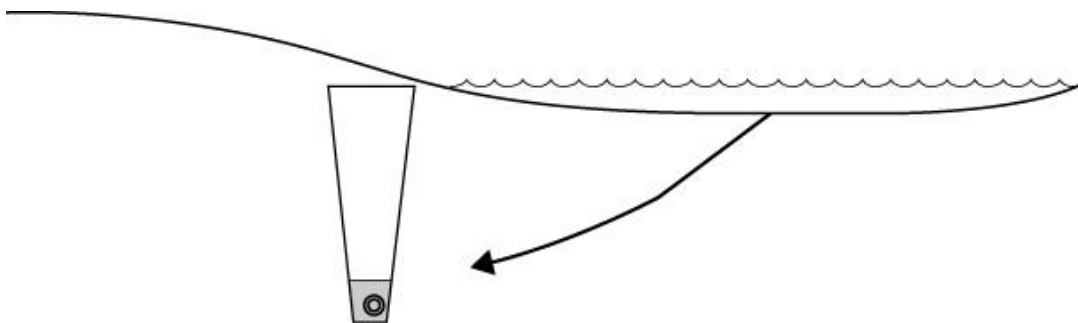

This arrangement also complies with the requirements of the DWSNZ, provided the distance is greater than 7.5 m for 0.5 log credit or 15 m for 1 log credit, and the material has a  $d_{10}$  of  $<1$  mm.

An example of this type of gallery can be found at Coal Creek, Greymouth.

The bank filtration mechanism operates by the normal methods of filtration, not unlike the slow sand filtration process (see Chapter 14):

- direct mechanical screening, ie, stopping the transport of large particles. The material will stop particles that are 30 percent of its  $d_{10}$  or bigger. So, if the  $d_{10}$  is 1 mm, it will stop particles of 300 microns and more
- settling of particles on to horizontal layers in the sand
- spinning out particles at tight corners, sending them into quiet areas where they settle out
- adsorption of particles on to the surfaces of the material
- grazing of micro-organisms by resident biota.

Bank filtration also significantly reduces soluble organic material in surface water. This is probably because the organic material is electrostatically attracted to the surface of the filtration material where tiny aquatic animals graze.

As noted above, organic material in surface water decays over time. Thus the ideal time to abstract the raw water is after most of the particles have been removed but before any dissolved organics have produced carbon dioxide, which would lower the pH and dissolve iron or manganese from the soil.

**Design loading rates** for infiltration galleries are usually around 0.2–0.5 litres per second per metre of length, with the pipes sized to keep velocities under 0.7 m/s. The general rule is the lower the loading rate, the better the result.

The pipe should also be large enough to allow for maintenance; an internal diameter of at least 150 mm will allow access for cleaning. The size of the slots should allow a maximum hole velocity of 0.3 m/s, as for well screens.

It is normal to pack the gallery pipe into a filter pack with material graded to limit soil migration. This filter pack is usually five times the  $d_{30}$  (ie, the size that 30 percent of the material is finer than) of the parent country.

Typical groundwater flow rates into the galleries/wells are around 1.5–15 m/d (USEPA 2003a). For the design loading rates of 0.2–0.5 L/s/m, this requires a flow path between 3 m and 10 m wide.

**Maintenance requirements** are usually very low. The very high surface area gives low surface loading rates, with little build-up of material on the soil-water interface. Normally, stream erosion is adequate to keep this surface sufficiently clear.

Some galleries are fitted with air scour header pipes to blow air through the filter material. Care should be taken with this, as air bubbles that get trapped act as aquicludes, thus reducing the flow (or increasing the headloss) through the aquifer.

Bank filtration can protect a river intake to a very high degree. There are several examples in New Zealand that achieve extremely good turbidity reduction, including the Opihi gallery in Timaru, which reduces from about 150 NTU to about 2 NTU under flood flows.

For further information about the advantages and disadvantages of this technique, site selection and aquifer requirements, design, construction and operational consideration, see USEPA (2006). Refer also to Chapter 4 of the review draft LT2ESWTR Toolbox Guidance Manual (USEPA 2009) which discusses issues related to bank filtration.

Aqualinc (2014a) conducted a literature review of design features and performance of different types of infiltration galleries. The objectives were to:

- to identify the cause of past gallery non-performance and failures
- to determine possible solutions to the problems
- to prepare a set of guidelines for design, construction, maintenance and operation of galleries that will minimise the effects of the in-stream and riverbed environments.

Aqualinc (2014b) produced guidelines for those involved in the planning, appraisal, approval, funding, design, construction, operation and maintenance of intakes that use infiltration as a method to capture, control and distribute river water. The guide discusses the advantages and limitations of using infiltration galleries and provides the information to assist practitioners who decide whether, in given circumstances, infiltration galleries are appropriate. Water quality issues are not included.

## 12.3.2 Off-river storage

Off-river raw water storage reservoirs are basins located between a water source (typically a river or stream) and the water treatment plant. They can range from an impoundment in a side valley, to a constructed lagoon system on the flat. They can overcome the problems of damming the main stream and its associated problems of higher costs, fish migration and perhaps even navigation.

It may be possible to avoid taking water from rivers and streams when water quality is poor (eg, following heavy rainfall) in order to reduce risk and to prevent potential problems in subsequent treatment processes. Rather than operate a stop/start treatment plant with its associated uncertainty of continuous supply, it may be more convenient to use off-river storage. Holding pumped water in a side valley at a higher elevation may enable gravity-feeding the treatment plant, reducing peak power prices.

Off-river storage can be helpful to ensure an adequate supply of raw water in situations where the run of stream flow is very low during dry periods.

By decreasing the contamination of the raw water, the protozoal log credit requirement may be lower, and the amount of treatment required can possibly be reduced. For example, a stream or river typically may have a turbidity of 1–4 NTU, and if the raw water colour is low, chemical coagulation may not be needed. This means diatomaceous earth, slow sand, membrane, cartridge or bag filtration could provide a suitable one-step treatment. Alternatively, if the colour level does require chemical coagulation, a consistently low turbidity raw water should allow use of a direct filtration plant. However, in New Zealand conditions, it is not unusual for the turbidity in streams or rivers to exceed 50 NTU quite suddenly due to heavy rain in the catchment. If the

off-river storage system is only filled while the run of stream water is below (say) 5 NTU, these filtration systems should not be compromised.

It is quite common for other determinands to exhibit elevated levels when the turbidity is high, eg, colour, micro-organisms and nutrients. If the nutrient input to the off-river storage is low, the risk of nuisance algal growths should be minimised; in most cases this can be achieved by turbidity control. If a cyanobacterial bloom or other problem develops in the off-river storage, it should be possible to draw raw water from the river until the cyanotoxin levels are reduced, and vice versa.

Similarly, the off-river storage could be filled selectively to overcome other problems. For example, if the natural organic matter in the run of stream water increases during certain conditions, potentially causing undesirable levels of disinfection by-products (DBPs) in the drinking-water, online UV absorbance could be used to determine when to stop drawing from the river, or stop filling the off-river storage.

Retention of water in reservoirs can reduce the number of micro-organisms through settling and inactivation, including solar (ultraviolet) disinfection. Most pathogenic micro-organisms of faecal origin (enteric pathogens) do not survive indefinitely in the environment. Substantial die-off of enteric bacteria will occur over a period of weeks of storage. See Table 12.1 which is based on Table 4.3 in Chapter 4 of WHO (2003). Section 4.3.3 of WHO (2003) discusses survival rates in groundwater.

**Table 12.1: Reduction times for selected micro-organisms in surface water**

| Micro-organism                 | Time for 50% reduction of concentration (days) |
|--------------------------------|--|
| <i>Cryptosporidium</i> sp.     | 15–150   |
| <i>Giardia</i> sp.             | 3–30   |
| enteroviruses                  | 3–70   |
| hepatitis A                    | 3–14   |
| rotavirus                      | 1.2–2.4  |
| <i>Salmonella</i> spp.         | 0.1–0.67                                       |
| <i>Shigella</i> spp.           | 1  |
| <i>Vibrio cholerae</i>         | *  |
| <i>E. coli</i>                 | 1.5–3  |
| coliforms                      | 0.9  |
| enterococci                    | 0.9–4  |
| F-RNA phages                   | 29–230   |
| somatic coliphages             | 2–20   |
| <i>Clostridium perfringens</i> | 60–> 300                                       |

\* *Vibrio cholerae* is environmentally competent and in unfavourable environmental conditions is thought to survive for long periods in water in a non-culturable state.

Enteric viruses and protozoa can survive for longer periods (weeks to months) but are often removed by settling and antagonism from indigenous microbes.

Impoundment also allows suspended material to settle, which makes subsequent disinfection more effective and reduces the formation of DBPs.

The USEPA evaluated a number of studies that investigated the removal of *Cryptosporidium* and other micro-organisms and particles in raw water storage lakes. They summarised these studies (USEPA 2003a) in a table that has been reproduced here as Table 12.2.

**Table 12.2: Studies of protozoa removal from off-river raw water storage**

| Researcher             | Reservoir   | Residence time                    | Log reductions                                   |
|------------------------|---|-----------------------------------|--|
| Ketelaars et al 1995   | Biesbosch reservoir system: man-made pumped storage (Netherlands) | 24 weeks (average)                | <i>Cryptosporidium</i> 1.4<br><i>Giardia</i> 2.3 |
| Van Breeman et al 1998 | As above  | 24 weeks (average)                | <i>Cryptosporidium</i> 2.0<br><i>Giardia</i> 2.6 |
| Van Breeman et al 1998 | PWN reservoir   | 10 weeks (average)                | <i>Cryptosporidium</i> 1.3<br><i>Giardia</i> 0.8 |
| Bertolucci et al 1998  | Abandoned gravel quarry used for storage (Italy)                  | 10 weeks (average)                | <i>Cryptosporidium</i> 1.3<br><i>Giardia</i> 0.8 |
| Ongerth 1989           | Three impoundments on rivers with limited public access           | 40, 100 and 200 days respectively | <i>Giardia</i> : no removal observed             |

USEPA was unclear why no decrease in cyst levels was observed in the Ongerth study. They felt it was possible that contamination of the water in the impoundments by *Giardia* from animal sources, either directly or through localised runoff, may have occurred.

Results of other studies are reported in Chapter 2, section 2.1.3 of WHO (2004b).

Refer to section 8.4.1.2 in Chapter 8: Protozoa Compliance for a discussion why the USEPA does not award log credits for off-river storage. However, with respect to determining the catchment risk category in the DWSNZ (section 5.2.1.2), water suppliers in New Zealand are able to take advantage of any benefits from off-river raw water storage by sampling after the storage.

Off-river storage also provides opportunities for contamination to be introduced, depending on the surrounding topography and land-use. Constructing cut-off drains around the storage lake or reservoir can reduce the effects of contamination from the run-off due to grazing animals. Contaminated tributaries can even be diverted. Ducks, seagulls and shags can find the storage attractive too, so may need to be discouraged. For further discussion, see Chapter 3: Source Waters, section 3.3.2.

Many of the benefits of off-river storage are related to the hydraulic retention time. This can vary day-to-day or seasonally, depending on:

- the filling rate allowed by the regional council
- whether there is a requirement to release water
- the size of the off-river system catchment
- whether direct-hit rain water is significant to the water balance
- the abstraction rate to the water treatment plant

- how much short-circuiting occurs (under different inflow and water level situations)
- whether the lake stratifies (if it does, its effective retention time is greatly reduced)
- whether stratification is broken down by artificial aeration.

Management of lakes and reservoirs is discussed in chapter 3, section 3.3.2. See also NIWA (2012).

## 12.3.3 Presedimentation

Presedimentation may be used to remove animals, floating macrophytes, gravel, sand, and other large or gritty or floating material from the source water, and to dampen particle loading to the rest of the treatment plant. Presedimentation is similar to conventional sedimentation, except that presedimentation may be operated at higher loading rates and may not involve use of chemical coagulants. Also, some water supplies operate the presedimentation process periodically and only in response to periods of high particle loading.

Sometimes a presedimentation basin is no more than a pond that has been dug out between the intake and the water treatment plant. To enhance their performance, a coagulant is sometimes added, often crudely.

### a) Presedimentation without coagulant

Presedimentation without coagulant is simply settling the raw water before any treatment, thereby allowing heavier solids to drop out. It is more commonly used for river sources that are subject to very high solids loadings. It is particularly effective in removing or reducing coarse solids such as branches, gravels and sands. Without chemical aids such as coagulation, it is not effective at reducing fine silts, clays or organic materials.

Presedimentation is usually carried out in a tank or small natural basin. The use of much larger basins can be called off-river storage (section 12.3.2).

On its own, presedimentation involves installing a settlement device such as:

- a clarifier tank with a sloping bottom, or
- a clarifier with a scraped bottom, or
- a plate or tube settler.

For any of these, the key loading feature is the overflow rate. This is the flow into the device divided by the plan area of the settlement surfaces. For a tank, this is simply the plan area of the tank; for tube and plate settlers, it is the total plan area of horizontal surfaces. To settle a particular kind of particle, the overflow rate must be no faster than the speed at which that particle falls.

Because small particles tend to settle more slowly than large ones, the slower the overflow rate, the smaller the particles removed.



Clays and organic materials are very slow to settle and difficult to remove without chemical additives, such as coagulants, or by using very fine filtration such as membranes. Silts settle a little faster, but still very slowly. For example, 2 micron silt particles will settle at about 10 mm/h. If the flow into the tank is 100 m<sup>3</sup>/h, the area of the tank will have to be 100 divided by 0.01; ie, 10,000 m<sup>2</sup>, or three football fields!

This can be speeded up significantly by coagulation. Alum floc particles typically settle at around 2 m/h. So, at the same flow rate, the area needed would be only 100 divided by 2, ie, only 50 m<sup>2</sup>.

Sand settles faster than silt. For example, at 600 microns, it will fall at around 900 m/h. Using the same flow rate, the area required is only 100 divided by 900, ie, 0.11 m<sup>2</sup>.

In practical terms, it is feasible to remove sands, difficult to reduce silts, and virtually impossible to remove clays and organics unless very large areas are used.

Presedimentation without storage as well is not common in New Zealand. The few examples include Mt Grand water treatment plant in Dunedin, which has a parallel plate separator with a loading rate of around 10 m/h. This is being replaced with raw water off-river storage, primarily for an emergency supply, not as a settlement step.

Reservoirs commonly cover very large areas, because it is usually uneconomical to make them deep. This means they are very effective as settlement devices. The settlement function of a raw water reservoir combines very well with its other purposes, such as mixing and emergency reserves. Again, the settlement achieved can be estimated from the plan area of the reservoir; the depth (provided it is enough to limit currents) is not important.

To see why the depth does not matter, consider what happens if the depth is doubled. The particle now has to fall twice as far to fall to the floor, but it has twice as long to do it in. Why? Because the horizontal flow through is now half of the original speed. Therefore, depth does not matter.

## b) Presedimentation with coagulant

The USEPA (2003a) proposed in its draft LT2ESWTR to award a presumptive 0.5 log *Cryptosporidium* treatment credit for presedimentation that meets three criteria (refer to Chapter 8: Protozoa Compliance, section 8.4.1.3 Presedimentation (with coagulation) for details of the criteria).

Calling this process presedimentation is a misnomer because the USEPA really considers this to be the sedimentation step in the coagulation, sedimentation, rapid gravity sand filtration process, ie, what the USEPA calls conventional full treatment, hardly a pretreatment process. Therefore presedimentation with coagulant is discussed in Chapter 13: Coagulation Processes.

## 12.3.4 Prefiltration

Prefiltration is used to remove large solids from the raw water before it is treated. The process usually involves screens and the filtration process is purely mechanical; it is not chemically assisted. Section 12.3.6 discusses roughing filters.

Prefiltration is often used at river and reservoir intakes, where a coarse screen prevents large solids that can block valves, such as fish, parts of trees and the like, from being taken in. The holes in the screen are usually 1–2 mm, although some are significantly coarser than this.

Types of screens include:

- fixed bar screen, usually with the bars vertical. These require raking from time to time, often manually, sometimes automatically
- fixed bar screen mounted on to the downstream face of the weir. These allow water flowing over them to fall into the intake chamber inside the weir structure. If debris builds up against the screen and blocks it, the flow of the water tends to push it off again and back into the river. These screens are suitable only for small streams, because the weir has to carry the entire flow. They require very little maintenance
- fixed mesh screen. These are not very common, as the mesh is below the surface of the water and is therefore very difficult to get at and clean
- liftable mesh screen. These are often mounted on a steel frame and are quite heavy. Some are lifted by electric winch, others by a towrope off a vehicle. They are relatively common.

Most intake screens are sized based on a surface velocity of less than 0.15 m/s.

Following this initial screening, prefiltration can be by:

- 1 Rotating drum screen, similar to those used in wastewater. These are not commonly used in water supplies. Their cost (both initial and operating) is high and they are not so much more effective as to warrant the expense.
- 2 Stepping screen. These resemble, and operate like, escalators. The solids are lifted out of the water by the steps and are washed off before the steps come around again to re-enter the water. They are more common than rotating drum screens and are often used to remove leaves and coarse algal material. An example can be found at Oamaru.
- 3 Washable disc filters. These comprise a stack of discs mounted one on top of the other, with the gaps between them set by bumps on the discs. The water passes through a hole in the middle of the rings. The gaps between the discs range from 100 microns, down to about 5 microns, which is still too big to capture micro-organisms, silts, clays or natural organic matter, so they do not qualify for protozoa log credits in the DWSNZ. For backwashing, they are unclamped to loosen them before the cleaning flow starts. They also need to be stripped down occasionally (six-monthly or yearly) and, for many applications, soaked in acid or caustic soda. They are very useful filters in many applications. Two of the commoner brands available in New Zealand are Amiad and Arkal, both from Israel. Some models are automatically or continuously cleaned.

- 4 Washable mobile media such as sand filters. These present a good barrier against a lot of particles, including quite small, turbidity-causing silts and clays. Typically, they act as the equivalent of about 10 micron filters. They are washed by air/water scour in the same way as conventional gravity rapid sand filters. They differ from normal rapid sand filters by having very high loading rates, too high to prevent floc from being sheared and passing through the sand. They do not qualify for protozoa log credits in DWSNZ.

Prefiltration is often used upstream of another process to reduce its load. For example, sand filters (single or multimedia) or 5 micron cartridge filters can be installed upstream of 1 micron cartridges being used for protozoa removal, or used to reduce the turbidity prior to a disinfection process.

### 12.3.5 Microstrainers

Microstrainers are useful for removing algal cells and large protozoa such as *Balantidium coli*, but have no significant impact on bacteria or viruses (WHO 2004b).

Several microstrainers were installed in New Zealand about 40–60 years ago. Some may still be operating. They may still be practical for some source waters.

Microstrainers are revolving drum screens made of the finest stainless steel mesh available, with gaps as small as 23 microns. This size is regarded as adequate to remove lumps too big for chlorine to penetrate. Microstraining followed by chlorination therefore can ensure inactivation of bacteria and viruses.

A microstrainer is typically a cylinder with mesh walls, revolving on its side about three-quarters immersed in water. The raw water enters through one end (the other is closed) and flows out through the mesh into the tank that contains it. The solids are caught on the inside surface of the mesh as the cylinder rotates. At the top of the rotation, they are washed off by high-pressure sprays from outside and collected in a trough mounted just above the inside water level. The difference between the inside and outside water levels, the so-called straining head, is around 40–60 mm.

Washwater use is around 1.5–2.5 percent of flow through the plant. No chemicals are used and the washwater can usually be returned directly to a stream.

The loading rate varies depending on mesh size and raw water quality, but is about 25–40 m/h through the total screen area.

Microstrainers were installed at many sites in New Zealand in the 1960s and virtually all have since been replaced because they do not present an adequate barrier to protozoa such as *Giardia* and *Cryptosporidium* and do not remove colloidal matter. One plant operating in Dunedin is being replaced with a membrane plant, and there are several in private plants such as meat works.

## Algae removal

High populations of phytoplankton can cause problems with different types of water treatment.

The numbers of cells per litre in eutrophic lakes can be so high that processes such as cartridge, membrane, diatomaceous earth or slow sand filters can block quickly and become uneconomic.

Chemical coagulation plants can also be affected. During daylight hours, algae produce oxygen, creating bubbles that can cause the sludge blanket to rise and perhaps break up. The resultant floc carryover can put an excessive load on the filters. The algae can also grow on the sand beds, shortening filter runs. Some algae can be difficult to remove during backwash.

Killing the algae with chlorine or ozone at the treatment plant could result in taste and odour problems as the organisms decay.

Microstrainers can remove a large percentage of the cells without introducing excessive headloss. The drum speed can be increased if the algae begin to block the microfabric. The microfabric is available in a range of mesh sizes, from 23 microns to 65 microns. Laboratory trials can help select the most appropriate mesh.

Between a third and a half of reservoir algae (about 700 cells per mL in a New Zealand raw water) have been removed by a 65 micron microstrainer.

During trials for a new Auckland water source, about 90 percent of Waikato River phytoplankton were removed by a 23 micron microstrainer. On average, these organisms were a little larger than the reservoir species. Despite the high removal of phytoplankton, the turbidity did not decrease much, indicating that those phytoplankton did not contribute greatly to the turbidity measurement.

In both cases, colonies and larger cells were removed more effectively than small cells.

### 12.3.6 Roughing filters

According to the USEPA (2003a), roughing filtration is a technique used primarily in developing countries to remove solids from high turbidity source waters prior to treatment with slow sand filters.

A roughing filter contains coarse media (typically rock or gravel) and is used to reduce turbidity levels before processes such as slow sand filtration, diatomaceous earth (DE) or membrane filtration. The American Water Works Association Research Foundation (AWWARF) has reviewed design variables for roughing filters (Collins et al 1994, quoted in WHO 2004b).

Typically, roughing filters consist of a series of sedimentation tanks filled with progressively smaller diameter media in the direction of the flow. The media can be gravel, plastic, crushed coconut, rice husks, or a similar locally available material. The flow direction in roughing filters can be either horizontal or vertical, and vertical roughing filters can be either upflow or downflow. The media in the tanks effectively reduce the vertical settling distance of particles to a distance of a few millimetres. As sediment builds on the media, it eventually sloughs off and begins to accumulate in the lower section, while simultaneously regenerating the upper portions of the filter. The filters require periodic cleaning to remove the collected silt.

Originally it was thought that the USEPA would recommend a 0.5 protozoa log credit towards additional *Cryptosporidium* treatment requirements for roughing filters. However, after review of available literature, the USEPA was unable to identify design and implementation conditions for roughing filters that would provide reasonable assurance of consistently achieving a 0.5 log removal of oocysts. Hence roughing filters do not appear in the DWSNZ, so are not discussed in Chapter 8: Protozoa Compliance.

Some research reported in USEPA (2003a) found that long filters (10 m) at low filtration rates (0.5 m/h) were capable of reducing high suspended solids concentrations (1000 mg/L TSS) down to less than 3 mg/L.

Other studies found roughing filters were capable of reducing peak turbidities by 80 to 90 percent, and faecal coliforms by 77 to 89 percent.

Roughing filters have their place as a form of pretreatment, especially for turbid or highly changeable river water.

## References

APHA, et al. 2005. *Standard Methods for the Examination of Water and Wastewater* (21st edition). Washington DC: American Public Health Association, American Water Works Association, and Water Environment Federation.

Aqualinc. 2014a. *Infiltration Gallery Investigation*. Aqualinc Research Ltd. Prepared for Marlborough District Council. Report No C14003/1. Envirolink Report 1402, 36 pp. March 2014. <http://www.envirolink.govt.nz/Envirolink-reports/>.

Aqualinc. 2014b. *Infiltration Gallery Guidelines: Design, construction, operation and maintenance*. Aqualinc Research Ltd. Prepared for Marlborough District Council. Report No C14003/2. Envirolink Report 1402, 34 pp. April 2014. <http://www.envirolink.govt.nz/Envirolink-reports/>.

Aqualinc. 2014b. *Infiltration Gallery Guidelines: Design, construction, operation and maintenance*. Aqualinc Research Ltd. Prepared for Marlborough District Council. Report No 14003/2. Envirolink Report 1402, 34 pp. <http://www.envirolink.govt.nz/Envirolink-reports/>.

AWWA. 1990. *Water Quality and Treatment* (4th edition). McGraw-Hill Inc.

- Bertolucci G, Gilli G, Carraro E, et al. 1998. Influence of raw water storage on *Giardia*, *Cryptosporidium* and nematodes. *Wat Sci Technol* 37(2): 261–7.
- Collins MR, et al. 1994. *Evaluation of Roughing Filtration Design Variables*. Denver, CO: American Water Works Association Research Foundation and the American Water Works Association.
- Ketelaars H, Medema G, van Breemen L, et al. 1995. Occurrence of *Cryptosporidium* oocysts and *Giardia* cysts in the River Meuse and removal in the Biesbosch Reservoirs. *Aqua* 44: 108–11.
- The New Zealand Ministry of Health’s Guides for drinking-water supplies can be accessed as Word documents on the Ministry of Health website: <http://www.health.govt.nz/water> then select publications and Water Safety Plans.
- Ministry of Health. *Public Health Risk Management Plan Guide PHRMP Ref. 1.1. Surface Water Abstraction – Rivers, Streams and Infiltration Galleries*. Wellington: Ministry of Health.
- Ministry of Health. *Public Health Risk Management Plan Guide PHRMP Ref. P3. Treatment Processes – Pre-Treatment Storage*. Wellington: Ministry of Health.
- Ministry of Health. *Public Health Risk Management Plan Guide PHRMP Ref. P4.3. Pre-oxidation*. Wellington: Ministry of Health.
- Ministry of Health. 2005. *Drinking-water Standards for New Zealand 2005*. Wellington: Ministry of Health.
- NIWA. 2012. *Guidelines for Artificial Lakes: Before construction, maintenance of new lakes and rehabilitation of degraded lakes*. NIWA Client Report No: HAM2011-045. 177 pp. <http://www.envirolink.govt.nz/Envirolink-tools/>.
- Ongerth J. 1989. *Giardia* cyst concentration in river water. *J AWWA* 81(9): 81–6.
- Pang L. 2009. Microbial removal rates in subsurface media estimated from published studies of field experiments and large intact soil cores. *J Environ Qual* 38(4): 1531–59.
- Sinton L. 1986. *A Guide to Groundwater Sampling Techniques*. National Water and Soil Conservation Authority, Water and Soil Miscellaneous Publication No. 99.
- Sprenger C, et al. 2014. Removal of indigenous coliphages and enteric viruses during riverbank filtration from highly polluted river water in Delhi (India). *Journal of Water and Health* 12(2): 332–42. doi:10.2166/wh.2014.134.
- Sundaram B, Feitz A, Caritat P de, et al. 2009. *Groundwater Sampling and Analysis: A field guide*. Commonwealth of Australia, Geoscience Australia, Record 2009/27, 95 pp. [http://www.ga.gov.au/image\\_cache/GA15501.pdf](http://www.ga.gov.au/image_cache/GA15501.pdf).
- USEPA. 2003a. *Long Term 2 Enhanced Surface Water Treatment Rule; Proposed Rule*. National Primary Drinking Water Regulations: 40 CFR Parts 141 and 142, 11 August. See Final Rule (2006).
- USEPA. 2003b. *Long Term 2 Enhanced Surface Water Treatment Rule: Toolbox Guidance Manual*, Chapter 4: Bankside Filtration. Draft. EPA-815-D-03-009. Washington: United States Environmental Protection Agency. See USEPA (2009) for latest version.

USEPA. 2004. *Protocol for Equipment Verification Testing of Volatile Organic Chemical Removal*. Environmental Technology Verification Protocol (ETV). 04/9209/EPADWCTR. Prepared by NSF. 138 pp. <http://www.epa.gov/etv/pubs/049209epadwctr.pdf>.

USEPA. 2006. *National Primary Drinking Water Regulations: Long Term 2 Enhanced Surface Water Treatment Rule: Final Rule*. (LT2ESWTR). Federal Register Part II, 40 CFR Parts 9, 141 and 142. Washington: National Archives and Records Administration. See <http://www.epa.gov/fedrgstr/EPA-WATER/2006/January/Day-05/w04a.pdf> <http://www.epa.gov/fedrgstr/EPA-WATER/2006/January/Day-05/w04b.pdf> <http://www.epa.gov/fedrgstr/EPA-WATER/2006/January/Day-05/w04c.pdf> or go to <http://www.epa.gov/lawsregs/rulesregs/sdwa/lt2/compliance.cfm>.

USEPA. 2009. *Long Term 2 Enhanced Surface Water Treatment Rule, Toolbox Guidance Manual Review Draft*. Go into <http://www.epa.gov/safewater/disinfection/lt2/> and then enter: toolbox guidance manual review draft in the 'search' box, or go to [http://www.epa.gov/ogwdw/disinfection/lt2/pdfs/guide\\_lt2\\_lt2eswtr\\_toolboxgm\\_revdraft\\_060809.pdf](http://www.epa.gov/ogwdw/disinfection/lt2/pdfs/guide_lt2_lt2eswtr_toolboxgm_revdraft_060809.pdf).

USEPA. 2010. *Long Term 2 Enhanced Surface Water Treatment Rule, Toolbox Guidance Manual*. EPA-815-R-09-016. 375 pp. [http://www.epa.gov/safewater/disinfection/lt2/pdfs/guide\\_lt2\\_toolboxguidance\\_manual.pdf](http://www.epa.gov/safewater/disinfection/lt2/pdfs/guide_lt2_toolboxguidance_manual.pdf).

Van Breemen L, Ketelaars H, Hoogenboezem W, et al. 1998. Storage reservoirs: a first barrier for pathogenic micro-organisms in The Netherlands. *Water Science and Technology* 37(2): 253–60.

WHO. 2003. *Assessing Microbial Safety of Drinking-water: Improving approaches and methods*. Published on behalf of the World Health Organization and the Organisation for Economic Co-operation and Development by IWA Publishing, London. Available at: [http://www.who.int/water\\_sanitation\\_health/dwq/9241546301/en/index.html](http://www.who.int/water_sanitation_health/dwq/9241546301/en/index.html).

WHO. 2004a. *Guidelines for Drinking-water Quality* (3rd edition). Geneva: World Health Organization. Available at: [www.who.int/water\\_sanitation\\_health/dwq/gdwq3/en/print.html](http://www.who.int/water_sanitation_health/dwq/gdwq3/en/print.html) see also the addenda.

WHO. 2004b. *Water Treatment and Pathogen Control: Process efficiency in achieving safe drinking water*. MW Le Chevallier, K-K Au (eds). ISBN: 1 84339 069 8. 123 pp. Published by IWA Publishing, London, UK. Available on the internet at: [www.who.int/water\\_sanitation\\_health/publications/en/index.html](http://www.who.int/water_sanitation_health/publications/en/index.html).

WHO. 2011. *Guidelines for Drinking-water Quality 2011* (4th edition). Geneva: World Health Organization. Available at: [http://www.who.int/water\\_sanitation\\_health/publications/2011/dwq\\_guidelines/en/index.html](http://www.who.int/water_sanitation_health/publications/2011/dwq_guidelines/en/index.html).

WHO. 2017. *Guidelines for Drinking-water Quality: Fourth edition incorporating the first Addendum*. Geneva: World Health Organization. 631 pp. [http://www.who.int/water\\_sanitation\\_health/publications/drinking-water-quality-guidelines-4-including-1st-addendum/en/](http://www.who.int/water_sanitation_health/publications/drinking-water-quality-guidelines-4-including-1st-addendum/en/).

WRF. 2014. *Removal of Volatile Organic Contaminants via Low Profile Aeration Technology*. 58 pp. <http://www.waterrf.org/PublicReportLibrary/4439.pdf>.

# Chapter 13: Treatment processes, coagulation

## Contents

|             |  |           |
|-------------|--|-----------|
| <b>13.1</b> | <b>Introduction</b>                    | <b>2</b>  |
| <b>13.2</b> | <b>Coagulation process</b>             | <b>5</b>  |
| <b>13.3</b> | <b>Coagulants and flocculants</b>      | <b>8</b>  |
| 13.3.1      | Definitions                            | 8         |
| 13.3.2      | Coagulants                             | 8         |
| 13.3.3      | Flocculants                            | 9         |
| 13.3.4      | Health effects                         | 9         |
| <b>13.4</b> | <b>Coagulation and flocculation</b>    | <b>10</b> |
| 13.4.1      | Overview                               | 10        |
| 13.4.2      | Jar testing                            | 11        |
| 13.4.3      | Performance and control                | 13        |
| <b>13.5</b> | <b>Clarification and sedimentation</b> | <b>15</b> |
| 13.5.1      | Overview                               | 15        |
| 13.5.2      | Clarifier types                        | 15        |
| 13.5.3      | Optimisation and performance issues    | 18        |
| <b>13.6</b> | <b>Lime softening and ion exchange</b> | <b>20</b> |
| 13.6.1      | Lime softening                         | 20        |
| 13.6.2      | Ion exchange                           | 21        |
| <b>13.7</b> | <b>Rapid granular media filtration</b> | <b>23</b> |
| 13.7.1      | Overview                               | 23        |
| 13.7.2      | Turbidity monitoring                   | 25        |
| 13.7.3      | Filter operation                       | 25        |
| 13.7.4      | Optimisation of the filtration process | 26        |
| <b>13.8</b> | <b>Second stage filtration</b>         | <b>29</b> |
|             | <b>References</b>                      | <b>30</b> |



## List of figures

|   |    |
|---|----|
| Figure 13.1: Conventional coagulation, sedimentation and filtration | 6  |
| Figure 13.2: Direct filtration                                      | 6  |
| Figure 13.3: Lamella plates   | 16 |
| Figure 13.4: Adsorption clarifier                                   | 16 |
| Figure 13.5: Dissolved air flotation (DAF)                          | 17 |
| Figure 13.6: Actiflo process  | 18 |
| Figure 13.7: Rapid granular media filter                            | 23 |

## 13.1 Introduction

This chapter covers the water treatment process of chemical coagulation, with or without sedimentation. It also covers the situation where sedimentation is not followed by rapid granular media filtration. The discussion on coagulation includes details of chemical coagulants and polyelectrolytes used in the process. The separate stages of coagulation: flocculation and conventional sedimentation (also called clarification) are included. In current terminology sedimentation is one of a number of processes that are grouped as clarification. New high-rate clarification processes, (lamella plates, tube settlers, buoyant media clarifiers, dissolved air flotation (DAF) and Actiflo®) are also covered in this chapter.

The discussion on filtration in this chapter covers only rapid gravity granular media filtration (pressure filters are used sometimes too). This is the most common filtration method following coagulation in use in New Zealand. Other filtration methods that do not normally involve coagulation, eg, diatomaceous earth, cartridge, slow sand and membrane filtration, are discussed separately in Chapter 14. Although coagulation is commonly practised with membrane filtration to remove colour, membrane filtration does not rely on coagulation for removal of protozoa and is therefore classified separately as filtration without coagulation, in terms of the *Drinking-water Standards for New Zealand 2005, revised 2008* (DWSNZ).

The combined process of coagulation and filtration is used commonly throughout New Zealand and is effective at removing dissolved and colloidal colour (natural organic matter), turbidity (suspended solids), algae (phytoplankton), bacteria, viruses and protozoa (eg, *Giardia* and *Cryptosporidium*). This treatment combination is often referred to as 'conventional treatment'.

The DWSNZ outline turbidity criteria and turbidity monitoring requirements that must be met by water treatment plants to ensure compliance with the protozoa criteria. Guidance on compliance with respect to coagulation and filtration is discussed in Chapter 8: Protozoa Compliance, section 8.3.2 of these Guidelines; this chapter concentrates more on operational aspects.

This chapter includes a section (section 13.6) that discusses lime softening. This usually operates at a pH that is high enough for calcium and magnesium salts to form a floc, so as well as softening the water, organic matter, turbidity and (oo)cysts can be removed. Therefore the process can earn protozoal log credits, see Chapter 8: Protozoal Compliance, section 8.4.2.1. Water softening (and other benefits) by using ion exchange is included in section 13.6 for completeness, although the process does not include coagulation and does not earn log credits. Softening is also discussed briefly in Chapter 18: Aesthetic Considerations, section 18.3, and in Chapter 19: Small, Individual and Roof Supplies, section 19.3.4.

The 2008 DWSNZ include a new section, section 5.17: Alternative processes: treatment compliance criteria, whereby water suppliers may apply to the Ministry of Health to have other treatment processes assessed for a log credit rating. This approach, which is explained more fully in section 8.4.5 of the Guidelines, allows water suppliers to apply for a log credit rating (or a variation to the prescribed log credits) for a treatment plant or process:

- a) not covered in sections 5.1–5.16 of the DWSNZ
- b) that performs demonstrably better than its compliance criteria
- c) that performs to a lesser, but reliable, level than specified in its compliance criteria.

Some process variation is normal and expected; however, too much variability can result in treatment failures, leading to waterborne disease outbreaks. An objective of the DWSNZ, therefore, is to keep process variability within acceptable limits. Understanding the causes of process variations should prevent recurrences. Problems may be able to be avoided and the time spent problem solving can be reduced by implementing an effective water safety plan (WSP – formerly known as public health risk management plans, PHRMPs).

Rapidly increasing plant production rates can cause sludge blanket disturbance and filter breakthrough. The main reason for this could be due to inadequate clear water storage at or near the water treatment plant (ideally at least 24-hour storage is recommended), or there is a need for more storage in the distribution system. The more consistent the treatment rate, the easier it is to maintain a good quality end product.

AWWA (2000) produced a series of manuals covering control of coagulation, filtration, softening, and the chemicals used for these, see full list at <http://www.awwa.org/files/Resources/Standards/StandardsSpreadsheet.xls>.

Risk management issues related to the treatment processes in this chapter are discussed in the:

- MoH Public Health Risk Management Plan Guide PHRMP Ref. P5.1: Treatment Processes – Coagulation/Flocculation/Sedimentation
- MoH Public Health Risk Management Plan Guide PHRMP Ref. P5.2: Treatment Processes – Dissolved Air Flotation
- MoH Public Health Risk Management Plan Guide PHRMP Ref. P5.3: Treatment Processes – Direct Filtration

- MoH Public Health Risk Management Plan Guide PHRMP Ref. P6.1: Treatment Processes – Rapid Sand Filtration
- MoH Public Health Risk Management Plan Guide PHRMP Ref. P8.1: Treatment Processes – pH Adjustment
- MoH Public Health Risk Management Plan Guide PHRMP Ref. P11: Treatment Processes – Plant Construction and Operation.

Records should be kept of all chemicals used in treatment processes. These should include the supplier, certification of the specification and grade of the chemical and datasheets, routine monitoring of the quality and standard of chemicals used, conditions of its supply and subsequent storage. Records of actual dosing of the chemical should show the chemical name, rates and quantity of the chemical dosed, the type and calibration of the equipment used. A method statement should give standard procedures in case of failure or breakdown of the system, with associated safety data sheets and Hazchem labelling for all chemicals used.

The Water Supply Managers' Committee of the New Zealand Water and Wastes Association (NZWWA) has been developing standards for chemicals used in water treatment. These cover aluminium sulphate, hydrated lime, three fluoride chemicals and three polyelectrolytes.

DWI (2011) has a list of chemicals that have been approved for use in water supply in the UK.

Documentation of the quality and quantity of chemicals used in the treatment process is important for the appraisal of the efficiency of the processes being used, and may affect which Priority 2 determinands are assigned to a supply and the frequency of sampling required for them.

The Hazardous Substances and New Organisms (HSNO) Act 1996 now controls the use of the following chemicals:

- chlorine gas
- calcium hypochlorite
- sulphuric acid
- hydrochloric acid
- sodium hydroxide
- aqua ammonia
- hydrogen peroxide
- potassium permanganate.

Since 1 October 2004 users may need a Location Test Certificate and/or an Approved Handler Test Certificate. Details are available by using the Step-by-Step Guide to Finding Controls and Other Useful Links at [www.ermanz.govt.nz](http://www.ermanz.govt.nz).

DWI (2013) investigated the incidence of impurities in chemicals used in the UK for water treatment. Chemicals used in the UK must be permitted under regulation 31 and normally this means the chemicals conform to a European or national standard, such as a BS EN, or the introduction or application of the chemical has been specifically approved by the Secretary of State. Unexpected contaminants can occur in chemicals even though they are compliant with the regulatory requirements. For example, a 2008 study found evidence of N-nitrosodimethylamine (NDMA) contamination of ferric coagulants (which otherwise conformed to the relevant BS EN standard). The use of this chemical gave rise to small but detectable concentrations of NDMA in drinking water. There were few reported concerns in the US about specific trace contaminants. The most frequent complaints were associated with gross contaminants, such as sediment or floating debris in liquid chemicals. While the source of the contamination was sometimes traced to a deficiency in the manufacturing or refining process, the most frequently reported incidents occurred during transport, primarily associated with improperly cleaned or maintained delivery containers or transfer hoses. DWI (2013) includes contaminant specs for several BS EN standards.

## 13.2 Coagulation process

Coagulation, flocculation and clarification, followed by rapid granular media filtration, are the key steps in conventional water treatment systems. This is a well-proven technology for the significant removal of colour and particulate matter including protozoa (eg, *Cryptosporidium* oocysts and *Giardia* cysts), viruses, bacteria, and other micro-organisms. Iron, manganese, tastes and odours may also be removed from the water by these processes.

If not removed, natural organic matter can react with chlorine to reduce disinfection efficiency and form chlorinated organic species, eg, disinfection by-products (DBPs), some of which are chemical determinands of health significance, see Chapter 10: Chemical Compliance and Chapter 15: Treatment Processes, Disinfection. Micro-organisms remaining in treated water may also pose risks to public health.

Conventional treatment (coagulation, sedimentation and sand filtration), as illustrated in Figure 13.1, has several distinct stages. A coagulant is added to neutralise the natural electrical charges on the colloidal particles that prevent them from agglomerating, and is rapidly mixed into the water to be treated. This process is referred to as the coagulation stage; it is sometimes referred to as the colloid destabilisation phase. The process water will then enter a flocculation chamber, where further chemicals may be added depending upon the raw water characteristics and the level and rate of treatment to be achieved. Gentle mixing during this stage allows particles to agglomerate and form settleable flocs.

**Figure 13.1: Conventional coagulation, sedimentation and filtration**

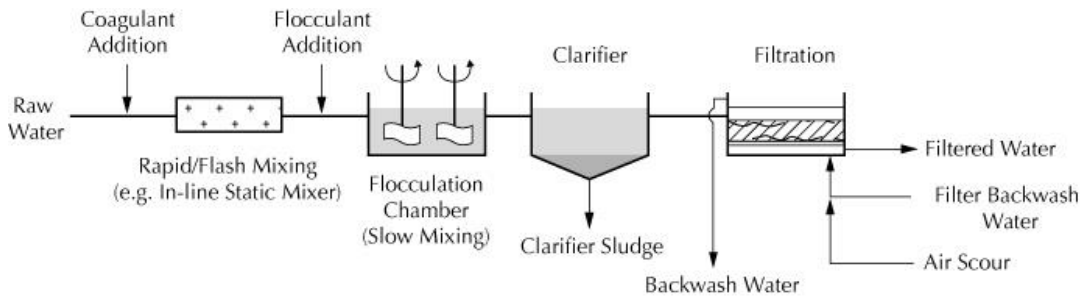

Clarification usually follows the flocculation process. Typically in New Zealand this involves sedimentation or settling, which allows the formed flocs to be separated for subsequent removal as sludge. Clarification is then followed by filtration which provides a second, polishing step for particulates that were not removed during the clarification step. The DWSNZ also cover the situation where rapid granular media filtration does not follow the sedimentation stage.

Some membrane filtration (MF) plants incorporate a coagulation and sedimentation step upstream of the MF step. The coagulation process may be continuous, or intermittent depending on the raw water quality.

For raw waters with consistently low colour (eg, less than 40 TCU) and low turbidity (eg, less than 10 NTU), direct filtration can be adopted, as illustrated in Figure 13.2. There is no clarification step in this case, and the coagulated water flows directly to the filtration process, providing the only particulate removal step. If the solids loading is too high, the filters will require frequent washing, which may lead to supply problems.

**Figure 13.2: Direct filtration**

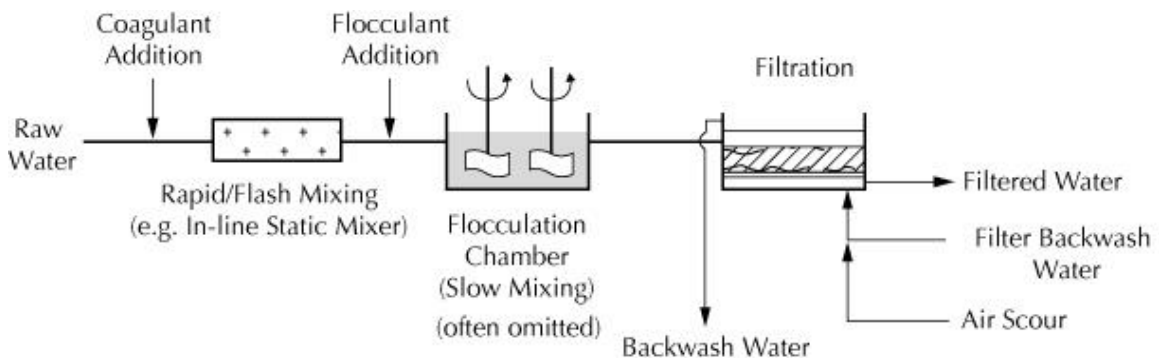

As new clarification processes are emerging and becoming increasingly common, further variances from the conventional coagulation/filtration process may become more common. Lamella plates can be installed in place of traditional sedimentation tanks, and tube settlers can be placed in the tanks. These do not alter the basic principles of the process, but they may improve the efficiency, reliability, and allow higher throughputs for the same footprint to be achieved.

Dissolved air flotation (DAF) can be installed in place of the conventional sedimentation tank (or clarifier) and this process floats, rather than settles, the flocs. Widely used in Europe and now becoming more common in North America, DAF can be used for treating moderate turbidity and high colour waters. It is especially effective at removing algae, which can be difficult to remove by sedimentation and would otherwise clog downstream filters, and for raw waters that produce flocs with poor settling characteristics. The DAF process can be a good choice for very cold water temperatures because it is more effective at removing the weak flocs that are commonly produced in such waters.

A further development, the Actiflo® process, is a ballasted flocculation process, which adds microsand to the flocculation chamber. Coagulation, flocculation and clarification are provided as a single unit.

A further variation is the buoyant media clarifier (also called the adsorption clarifier). This process combines the flocculation and clarifier into one stage, and effectively acts more like a filtration process, rather than a settling clarifier. This process is best suited for raw waters of lower turbidity.

See WHO (2004a) for a description of coagulation systems, some operational aspects, and a discussion on their ability to remove various organisms. Refer also to Chapter 5 of the review draft LT2ESWTR Toolbox Guidance Manual (USEPA 2009) which discusses issues related to sedimentation.

The USEPA talks of 'enhanced coagulation' as though this were a new type of water treatment process. USEPA (2007) states that enhanced coagulation can include one or more of the following operational changes:

- increasing the coagulant dose
- changing the coagulant
- adjusting the pH (eg, using acid to lower the pH to as low as 5.5)
- improving mixing conditions or applying a moderate dosage of an oxidant
- adding a polymer.

Some advantages of enhanced coagulation are said to include:

- improving disinfection effectiveness
- reducing DBP formation
- reducing bromate formation
- enhancing arsenic and radionuclide removal.

Based on the above, 'enhanced coagulation' would seem to be little more than optimising the conventional process.

# 13.3 Coagulants and flocculants

## 13.3.1 Definitions

The addition of certain chemicals into the raw water causes particles to destabilise and allows agglomeration and floc formation to occur. The general terms for chemicals used for this purpose are:

- coagulants, which assist the destabilisation of particles (particularly colloidal sizes)
- flocculants (also known as flocculant aids or coagulant aids), which assist in the joining and enmeshing of the particles together. Most flocculants used today are polyelectrolytes.

## 13.3.2 Coagulants

Most New Zealand water treatment plants use aluminium-based coagulants (eg, aluminium sulphate (alum) or polyaluminium chloride (PACI – PACI is the preferred acronym because PAC can also mean powdered activated carbon). Aluminium chlorohydrate (ACH) has limited usage, mainly in membrane filtration. A very small number of plants use iron-based coagulants (ferric chloride or ferric sulphate). Although alum and PACI are most commonly used, other coagulants may have benefits in particular applications, such as low turbidity waters. NZWWA (1997, revised 2012) published the second edition of a standard that covered aluminium-based coagulants.

PACI and ACH are two of a number of pre-hydrolysed metal salt coagulant solutions that have been developed in recent years. The key characteristic of this class of coagulants is that they consume less alkalinity when added to the raw water, and are less affected by low water temperatures than alum.

In addition to aluminium and iron-based (inorganic) coagulants, organic chemicals known as polyelectrolytes may also be used as coagulants or flocculant aids, to assist in producing low turbidity levels in treated water. This is particularly necessary for high rate clarification and high rate filtration processes.

Polyelectrolyte coagulants such as polyamines, polyacrylamides, and polyDADMACs are used occasionally in New Zealand as the primary coagulant, especially on low turbidity, low colour waters, where treatment is by direct filtration. They can also be used in conjunction with inorganic coagulants, in which case they are referred to as coagulant aids or flocculants.

### 13.3.3 Flocculants

Polyelectrolytes are now commonly used as flocculants in the majority of water treatment plants in New Zealand. Used as a flocculant aid the polyelectrolyte is added following coagulant dosing to increase the size, strength and settleability of flocs. Polyacrylamide-based polyelectrolytes are the most commonly used flocculants in New Zealand. These may be cationic, anionic, or non-ionic. They are produced with varying degrees of ionicity and in a range of molecular weights. Generally, the higher the MW, the more effective the polyelectrolyte. Cationic polyelectrolytes usually perform better in New Zealand waters.

To achieve their full effectiveness, polyelectrolytes are added after the primary coagulant (eg, alum). A contact time of at least three minutes is not uncommon. Contact time in this context is the time the water takes to flow between the two dosage points.

### 13.3.4 Health effects

For some time concerns have been raised in the international technical literature and by interest groups about whether there are adverse health effects on consumers from residuals of chemicals in drinking-water following treatment. As an example, some communities have opted not to use aluminium-based coagulants because of unsubstantiated reports that claim that the aluminium in drinking-water poses a risk to public health, despite scientific evidence (eg, Srinivasan et al 1999) that adverse effects have not been demonstrated. Because there is no evidence of health risk, based on WHO (2004), the DWSNZ do not have a Maximum Acceptable Value (MAV) for aluminium. WHO (2012) does not change this point of view. These Guidelines include a datasheet for aluminium. Alternatives to aluminium coagulants exist, eg, iron-based coagulants such as ferric chloride, but there may be performance and cost penalties associated with their use.

Proven concerns do exist for kidney dialysis patients if the water that is used by the patient as the dialysate liquid contains high concentrations of residual aluminium. Users of dialysis machines should be advised to provide specific pre-dialysis treatment to ensure that residual concentrations of aluminium and some other contaminants potentially introduced by treatment chemicals and distribution materials are kept to acceptably low levels. This is absolutely critical if aluminium is being used in the treatment of a supply for the first time, even though DWSNZ are (strictly speaking) only applicable to water intended for drinking (refer section 1.3 of DWSNZ).

If water treatment chemicals are used in such a way that their residual concentration in the drinking-water does not exceed the MAV, available research indicates there will be no significant risk to health from drinking the water for a lifetime. However, industry practice is to operate treatment plants significantly below these levels.



Only flocculants that are specifically manufactured for potable water use should be used in drinking-water treatment. Many of the monomers used in the manufacture of polyelectrolytes, and their impurities and resultant degradation products, are toxic, and the manufacturing process needs to be controlled properly to limit the quantity of unreacted monomer in the manufactured polyelectrolyte. For example acrylamide (a monomer residual of the manufacture of polyacrylamides) has proven toxicity and carcinogenicity (its MAV is 0.0005 mg/L). Epichlorohydrin (present in dimethylamine/epichlorohydrin cationic polyelectrolytes) also has a MAV listed in the DWSNZ (0.0005 mg/L). The NZWWA Standards (1999, being revised 2012/13) for the supply of three types of polyelectrolytes for use in drinking-water treatment outline minimum requirements to ensure that high quality and low impurity products are used in drinking-water treatment applications.

Part 3.4 of the index section of the datasheets lists the chemical determinands with health (or possible health) concerns that can be found in water treated with coagulants and flocculants.

The total dose of polyelectrolytes applied in the water treatment process should be controlled to limit the residuals in the treated water, see Chapter 10: Chemical Compliance. In particular, the doses applied in sludge dewatering need to be taken into account if the supernatant water is recycled into the treatment process.

## 13.4 Coagulation and flocculation

### 13.4.1 Overview

Coagulation and flocculation processes are intended to form particles that are large enough to be separated and removed by subsequent sedimentation, or alternative clarification processes.

The coagulation stage occurs when a coagulant, such as alum, is added to the water to neutralise the charges on the colloidal particles in the raw water, thus bringing the particles closer together to allow a floc to begin to form. The coagulant solution should be applied at a concentration of around 0.5 percent, and certainly less than 1 percent (WHO 2001). Rapid, high-energy mixing (eg, mechanical mixers, in-line blenders, jet sparge mixing) is necessary to ensure the coagulant is fully mixed into the process flow to maximise its effectiveness. The coagulation process occurs very quickly, in a matter of fractions of a second. Poor mixing can result in a poorly developed floc.

The flocculation process which follows coagulation, allows smaller particles formed during the rapid coagulation stage to agglomerate into larger particles to form settleable and/or filterable floc particles. After coagulant addition, the process water is mixed slowly for a defined flocculation period, commonly 10–30 minutes, however the optimum flocculation time will vary depending on the raw water quality and downstream clarification process. Gentle mixing during this stage provides maximum particle contact for floc formation, whilst minimising turbulence and shear which may damage the flocs. Effectiveness of flocculation depends on the delay time (or contact

time) and mixing conditions prior to any flocculants being added, the rate of treatment, water temperature and the mixing conditions within the flocculation chamber.

Contact flocculation is a variation from conventional flocculation in which the flocculation takes place within the clarification process. The coagulation step remains the same, however the flocculation chamber contains a contact medium. This medium traps the flocculating particles, which will then attach to other particles, thereby continually increasing the size of the flocs until the build-up of particles clogs the media. Backwashing is then required to remove the flocculated particles. Refer to Figure 13.4 (upflow adsorption clarifier).

## 13.4.2 Jar testing

The best approach for determining the treatability of a water source and determining the optimum parameters (most effective coagulant, required dose rates, pH, flocculation times, most effective flocculant aids) is by use of a jar tester.

As optimum pH and coagulant dose vary significantly with raw water characteristics, an initial thorough investigation into the variations in raw water quality from the source should help in the selection of the appropriate type of coagulation system to be used and its design. Unexpected variations in raw water quality can cause the coagulation process to be compromised, causing consequent problems with treated water quality.

The normal procedure when conducting a jar test is initially to find the best performing coagulant and dose rate, and then to determine the optimum pH for the chosen coagulant and dose rate. Performance is usually judged on turbidity, and then on colour (or UV absorbance) removal. Jar tests can also be used to compare the usefulness of different flocculant polyelectrolytes, but not their optimum dose rates; this must be done on the plant itself.

Standard aluminium and iron salt coagulants are acidic and therefore neutralise the alkalinity present in the raw water. Excess alkalinity (after the addition of coagulant) is needed to allow good floc formation. The optimum coagulant dose added at the wrong pH could result in almost no floc formation. In New Zealand's soft surface waters the optimum pH for coagulation is often only achieved by adding an alkali such as soda ash (sodium carbonate) or hydrated lime, perhaps in the range of 5–20 mg/L, see section 13.4.3.

A raw water with a high pH and a low coagulant demand may not reach the optimal pH without adding acid. However, unless the acid requirement is quite high, the optimum pH is usually achieved simply by adding excess coagulant. This should not be done if it unduly increases the concentration of aluminium in the finished water.

Smaller water treatment plants often choose to use PACl to avoid the need to dose alkali or acid, as PACl is much less acidic than alum and is usually effective over a broader range of pH values.

To assist in maintaining good control of the coagulation process, jar tests should be carried out routinely as part of the plant process control. The procedure should be conducted frequently, whenever changes in the characteristics of the raw water occur, eg, after rain, intake changes, etc, or when the water treatment plant is performing poorly.

Depending on the experience of the operator and the extent to which the raw water characteristics have changed since the current dose rates were chosen, the first set of jar tests usually trials a range of coagulant doses. Examination of the results should indicate which coagulant dose is closer to that required for removal of the colour and turbidity.

Many water supplies need a second set of jar tests at different pH values, to give an indication of where the optimum pH is likely to be. Subsequent jar tests fine up on the dosage selection. Generally, the more turbidity and colour there is, the higher the optimum coagulant dose. Experienced operators will know, usually from the turbidity, how much coagulant is needed to remove the solids (or colour) load. Alum or iron salts are usually dosed at about 15–50 mg/L (solid weight equivalent).

The individual jars are assessed for a variety of factors, including which developed a floc first, which jar's floc grew the fastest and became the largest, which settled fastest and which gave a supernatant with the lowest colour, turbidity and coagulant residual. Normally, the same jar scores best on each count. In some difficult waters the optimum dosage conditions are different for colour and turbidity removal, or the optimum dose for colour and turbidity removal results in excessive residual concentrations of coagulant entering the distribution system. These waters require extensive jar testing to determine the best compromise. The number of jar tests needed to determine optimum parameters is learned from experience.

Refer to AWWA (2000) for further information on the jar testing procedure.

Additional laboratory equipment useful for managing coagulation and subsequent treatment includes a bench turbidimeter, colour comparator, pH meter, alkalinity titration equipment and a spectrophotometer for measuring aluminium and possibly iron and manganese residual concentrations following treatment. Colour measurement is a fairly subjective test, and readings made by a group of people can have a wide spread. If the laboratory intends to use a spectrophotometer, it may be wise to purchase a UV/visible model, because for a particular water a correlation can be established between the true colour (Hazen units) and the UV absorbance measured in a 1 cm cell at 254 or 270 nm after filtration. UV absorbance is able to be measured quickly and reliably.

### 13.4.3 Performance and control

The performance of coagulation and flocculation is dependent on a large number of factors, many of which are inter-related, making optimisation difficult. Source water characteristics, chemical dose rates, mixing conditions, flocculation times, the selection of chemicals and their order of addition, treatment rates, water temperature, can all affect performance. Control of pH and alkalinity is also essential to maintain performance.

Clarifier and filter performance will also be directly affected by the overall performance of these stages of the process. It is therefore critical to maintain good performance and control of coagulation and flocculation for overall treatment plant performance.

Depending on the pH of the source water, pH adjustment prior to coagulant addition may be required to achieve the optimum pH levels. Subsequent readjustment will almost certainly be required to ensure acceptable pH levels in the distribution system.

The optimum pH for the coagulation process varies with the choice of coagulant. For aluminium sulphate it is usually 5.5 to 7.5, for ferric salts it may be within the range 5 to 8.5. The optimum pH will vary with changing raw water characteristics.

Many surface waters in New Zealand have an alkalinity of less than 20 mg/L as CaCO<sub>3</sub>. 1 mg/L of alum (measured as solid weight equivalent)<sup>1</sup> will consume 0.5 mg/L of alkalinity (as CaCO<sub>3</sub>). If all the alkalinity is neutralised, no more floc will form. Often the alum dose that is required to coagulate all the turbidity and colour present requires soda ash, caustic soda or hydrated lime to be dosed to provide the additional alkalinity and maintain control of the pH. This commonly occurs after heavy rain, and if the alkalinity and pH are not controlled, process failure can result, with turbid water and dissolved aluminium entering the distribution system.

Being a sensitive, physico-chemical process, coagulation/flocculation is most reliable when raw water quality is consistent, when changes occur slowly, or when adequate automation is used to respond to changes in raw water quality. Unfortunately, this is not true of many of our streams and rivers. See Chapter 12: Pretreatment Processes, section 12.3.2 for a discussion on the benefits of off-river storage.

As raw water conditions change, optimal coagulation dose rates also change and careful control is required to prevent overdosing and underdosing.

Overdosing can lead to excessive concentrations of coagulant entering the distribution system, and waste money. This can occur if the pH and alkalinity are not controlled at optimum levels too. The guideline value for aluminium (an aesthetic determinand) is 0.1 mg/L as Al, which is approximately equivalent to 1.1 mg/L as solid weight equivalent alum.

<sup>1</sup> Solid weight equivalent alum refers to Al<sub>2</sub>(SO<sub>4</sub>)<sub>3</sub>.14H<sub>2</sub>O (molecular weight of 594). New Zealand liquid alum is delivered as 47% w/w (equivalent to 62% w/v). Sometimes alum doses are reported as Al<sub>2</sub>O<sub>3</sub> (molecular weight of 102, 8.2% w/w of as-delivered liquid alum) or as Al (molecular weight of 54, 4.3% w/w of as-delivered liquid alum).

Underdosing can cause poor removal of colour, turbidity and micro-organisms.

Online monitoring of raw water quality determinands, such as pH and turbidity will aid treatment plant performance and assist in selecting optimum coagulation dose rates. It may be helpful to measure UV absorbance online if the raw water has high colour.

Severe rainstorms can seriously affect the quality of lake water, causing stress to the water treatment plant. With luck, the problem can be exacerbated by valve selection.

Water from the main tributary and side streams flowing into a lake or reservoir tends to find its way to water of the same specific gravity, which usually means water of the same temperature.

Rain falling during a cold southerly during the summer may be less than 10°C while the lake water may be about 20°C at the surface and 10°C at the bottom. This run-off will find its way to the bottom. Sometimes this can be observed visibly with the dirty flood water colouring the clean lake water – at the point where the flood water sinks there can be a distinctive plunge line. Until the lake water mixes, water from the upper valves remains relatively clean.

Flood water resulting from warm rain will remain on the surface, and until the particulate matter settles, water from lower valves may remain relatively clean for quite some time.

If the reservoir or lake is being aerated or circulated for manganese control the temperature will be much the same at all depths so the dirty run-off will tend to “blend” with the lake water, obviously assisted by the artificial mixing process.

Control of the coagulation process can be automated. Two control methods used in New Zealand for coagulation are the streaming current monitor (very common) and feed forward control (less common).

- Streaming current monitors measure the zeta potential (a measure of the electrical charge on the particles in the water) of the raw water following chemical addition and this can be used to adjust the coagulant dose rate accordingly as the raw water characteristics vary. This process was described by Ogilvie (1998).
- Feed forward control systems monitor natural organic matter (using UV light) and pH in the raw water prior to coagulant addition and predict the required coagulant dose rates to be applied.

# 13.5 Clarification and sedimentation

## 13.5.1 Overview

The term clarification, or sedimentation, is normally used to describe the settling of the flocs produced by the coagulation and flocculation process. This is distinct from presettling of highly turbid waters in detention ponds, which is discussed in Chapter 12: Pretreatment Processes, section 12.3.3.

Historically, clarification involved the simple principle of particle settling to separate the floc particles. New technologies such as dissolved air flotation (DAF), and high rate clarification processes, such as lamella plates, tube settlers, Actiflo®, and buoyant media clarification, have been developed and are being used increasingly. These clarification processes are illustrated in Figures 13.3 to 13.6 and are described below. The majority of the clarifiers in New Zealand are of the upflow, sludge blanket, hopper bottomed configuration. However, there are small numbers of most other designs including horizontal flow, DAF, buoyant media clarifiers and lamella settlers.

The surface loading rate is a key parameter in clarifier design, irrespective of the clarifier type. This is usually expressed in  $\text{m}^3/\text{m}^2/\text{h}$  (more correctly  $\text{m}^3/\text{m}^2.\text{h}$  or  $\text{m}/\text{h}$ ). This is the flow ( $\text{m}^3/\text{h}$ ) that occurs over the horizontal area ( $\text{m}^2$ ) of the settling zone of the tank. Acceptable surface loading rates vary significantly for the different clarification types from 2  $\text{m}/\text{h}$  for a hopper bottomed upflow clarifier, to 12  $\text{m}/\text{h}$  for a DAF process, to 40  $\text{m}/\text{h}$  for the Actiflo® process.

Chapter 5 of the review draft LT2ESWTR Toolbox Guidance Manual (USEPA 2009) discusses various types of sedimentation basins.

## 13.5.2 Clarifier types

### Conventional clarifiers

Conventional clarifiers (or sedimentation tanks) may be classified on the basis of flow direction (horizontal, radial, or upflow), the presence or absence of a sludge blanket, and shape (circular, rectangular, or hopper/wedge bottomed). A few earlier plants recycled a fraction of the sludge in an effort to enhance flocculation. Upflow clarifiers are suitable for a large range of raw water turbidities, however they are sensitive to flow changes. Flocculation times of 3–6 minutes are typical (further flocculation will continue to occur in the clarifier itself) whereas horizontal clarifiers require approximately 20–30 minutes flocculation time. Typical surface loading rates for conventional clarifiers are 2  $\text{m}/\text{h}$ . This can be increased to up to 5  $\text{m}/\text{h}$  if polyelectrolytes are used.

## Lamella settlers

Lamella settlers, Figure 13.3, make use of inclined plates or tubes to increase the effective surface area for settling (and hence are also known as plate or tube settlers), thereby increasing the efficiency of the clarification process. For a given throughput the footprint of a lamella settler will be considerably less than a conventional clarifier. Typical surface loading rates are 5–15 m/h. Lamella settlers are less vulnerable to flow fluctuations than conventional clarifiers.

**Figure 13.3: Lamella plates**

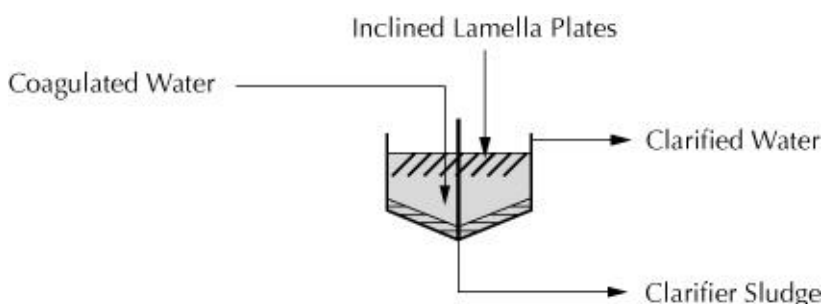

## Buoyant media clarifiers

Buoyant media clarifiers, or adsorption clarifiers, Figure 13.4, are a variant on the conventional clarification stage and combine flocculation and clarification into one step. The coagulated water passes through a medium of buoyant adsorption material (normally a plastic), kept in place by a screen. This allows contact flocculation to take place as flocs attach to the media and are thereby removed from the water. Solids will continually build up until the media clogs. Backwashing is then required to expand the media and remove the solids.

**Figure 13.4: Adsorption clarifier**

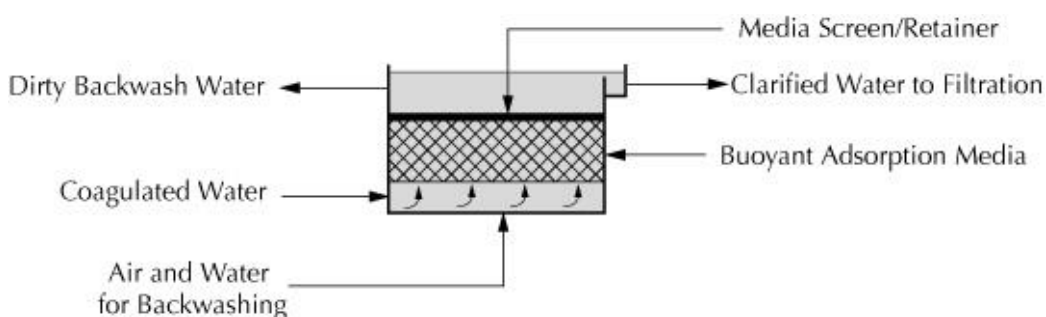

This process often requires a larger polyelectrolyte dose and is better suited to raw water sources with low turbidity and colour. High turbidities will very quickly clog the media and result in excessive backwashing. Typical surface loading rates of 19–25 m/h can be applied.

## Dissolved air flotation

Dissolved air flotation (DAF), as illustrated in Figure 13.5, is a clarification process particularly effective for removal of colour, and algae cells that are difficult to settle. It is suited to moderate levels of turbidity, and only small doses of polyelectrolyte are typically required. Surface loading rates of 10–12 m/h are common.

The process works by injecting very small air bubbles near the inlet of the flotation tank, which attach to flocs (usually aluminium based) formed in a separate flocculation tank, and floats them to the surface. Flocculation times of 15–20 minutes are typically required. Clarified water is then collected from near the tank bottom. A portion of the flow (approximately 5–10 percent) is recycled and saturated with air. The recycled water re-enters the flotation tank through a series of nozzles, causing a pressure reduction that releases small air bubbles from the saturated water.

**Figure 13.5: Dissolved air flotation (DAF)**

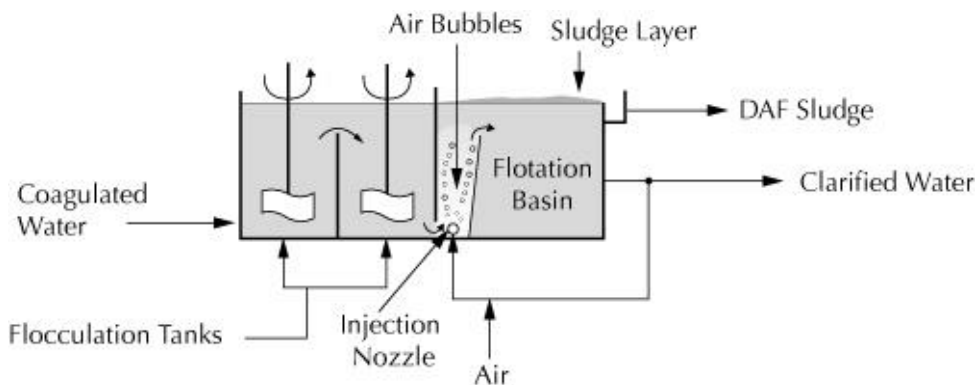

Floated flocs collect as a sludge layer on the water surface. Periodic desludging occurs either by hydraulic flooding of the flotation tank, the sludge layer spilling over a collection weir, or by mechanical skimming, which will form a thicker sludge.

The in-filter DAF (sometimes referred to as DAFF) is a variation of the typical DAF process in which the base of the DAF tank is made into a rapid granular media filter, thus incorporating clarification and filtration into one step.

## Pulsed blanket clarifiers

Pulsed blanket clarifiers use a vacuum system to create pulsations to hold the sludge blanket in suspension and aid flocculation, allowing for higher surface loading rates (up to 3 m/h). In the Superpulsator® system (installed at the Waikato Water Treatment Plant), clarification is enhanced by inclined plates, allowing surface loading rates of up to about 6 m/h.



## Actiflo

The Actiflo® process is a package plant, microsand ballasted clarification process, as illustrated in Figure 13.6. The process reduces flocculation times to approximately 5–10 minutes, and allows very high surface loading rates of 30–40 m/h (up to 100 m/h). There are no Actiflo® units operating in New Zealand as at 2005.

**Figure 13.6: Actiflo process**

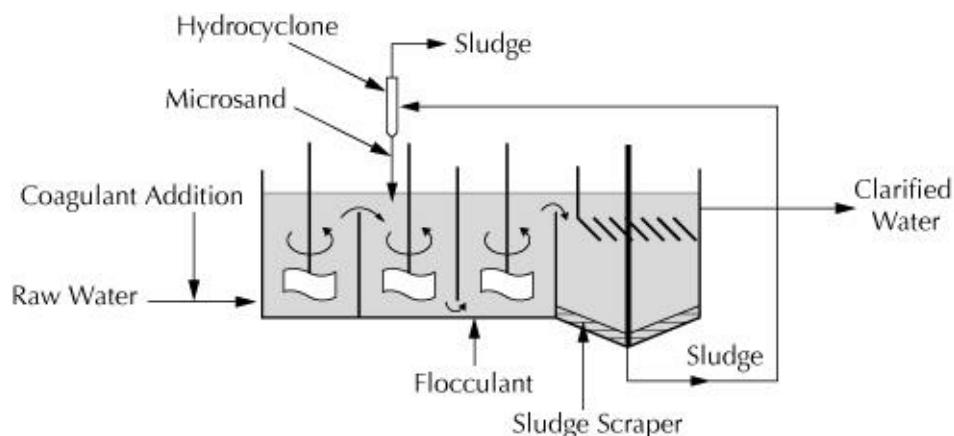

Coagulant addition and mixing occurs in the first chamber. Polyelectrolytes and microsand are added in a second chamber, and flocculation occurs in the third chamber. The flocculated water is then passed through a lamella settler. Settled sludge is collected and passed through a hydrocyclone, in which the microsand and floc particles are separated. The microsand is recycled back through the process and the sludge is separated for disposal.

The use of microsand as a seed for floc formation improves performance in two ways. The high specific area assists floc formation, whilst the high specific density improves the settleability characteristics of the flocs.

The Actiflo® process is similar in some respects to the Sirofloc process that was developed in Australia in the 1980s, except that the Sirofloc process uses 1–10 µm magnetite that behaves similarly to a coagulant when added (with acid) to the raw water. The resulting suspension is then subject to a magnetic field to form settleable flocs. The magnetite is recovered and reused.

### 13.5.3 Optimisation and performance issues

Most clarifiers will provide a reasonable level of treatment provided the upstream chemical dosing is optimised, and a reasonable surface loading rate suitable for the clarification type, is not exceeded. For example, studies on the removal of protozoal cysts in conventional treatment have shown that the clarifier is usually responsible for over 90 percent (1 log) of the (oo)cyst removal (USEPA 2003).

High effluent turbidities in water leaving a clarifier are indicative of poor performance. Flocs, which should have been removed in the clarifier, pass out and on to the filters. This will result in reduced filter run times and poorer filtered water quality. A well-operating clarifier should be able to produce an effluent of turbidity 2 NTU or less. Conventional clarifiers are sensitive to changes in flowrate, however, high rate clarification processes are less susceptible to such changes.

There is limited guidance for clarifier performance. The US Partnership for Safe Water Guidelines for Phase IV *Excellence in Water Treatment* sets performance goals as part of overall plant performance to achieve less than 0.10 NTU filtered water. This includes clarified water turbidity:

- less than 1.0 NTU 95 percent of the time when raw water is less than or equal to 10 NTU
- less than 2.0 NTU 95 percent of the time when raw water turbidity is > 10 NTU.

Despite this, it has often been found that the sedimentation process is more effective when the raw water is turbid; some earlier plants with low turbidity raw water took advantage of this by dosing bentonite into the raw water.

The rate at which particles settle is dependent on water temperature, or more accurately, water viscosity. In summer when the water temperature is perhaps 20°C, particles may settle up to 50% faster than in winter, when the water temperature is perhaps 10°C, however, most water treatment plants operate at a lower rate during winter.

A key aspect of consistently achieving <0.10 NTU filtered water turbidity is that changes in raw water turbidity should have minimal effect on clarified water turbidity, and negligible effect on individual filter turbidity. This requires optimisation of coagulation.

A common operational problem in clarifiers of the hopper-bottomed upflow type in New Zealand is for short-circuiting currents to occur, usually in summer and around the middle of the afternoon. This can be attributed to a temperature differential between the incoming water and the water in the tank. The result is a billowing of the floc blanket and subsequent carry-over of floc on to the filters. The same effect can be caused by algae in the sludge blanket becoming buoyant due to increased production of oxygen due to photosynthesis. High algal populations are needed for this effect to become a nuisance. Clarifiers with good inflow mixing do not seem to experience the same degree of problem. The only satisfactory solution to this problem, (apart from fitting tube settlers to the tank), appears to be to reduce the flow and hence the surface loading rate during the problem period.

Another common problem is excessive floc carry-over caused by uneven flows occurring over the clarifier surface. Inspecting and levelling the outlet weirs to ensure that all receive equal flows can correct this. If the flows are still uneven, the inlet flows to each clarifier must be checked, and adjusted so that they are even. For non-hopper bottomed clarifiers it is also important to ensure that the distribution of the flow within the clarifier is even.

Multiple tanks in larger plants often experience a high frequency wave in the outlet weirs that may disrupt the floc blanket. However, this generally does not cause a significant problem.

For clarifiers using a floc blanket, good control of the blanket surface and regular removal of floc from both the top and body of the blanket and base of the tank is important. In conventional clarifiers, the use of sludge (or gravilectric) cones gives better results than the earlier system of constructed corner pockets. Bottom sludge scours should be operated regularly (based on experience) to keep sludge fresh and to prevent excessive sludge build up. Bottom sludge has been known to go anaerobic at plants with a high level of organic matter or algae in the raw water.

Regular sludge removal is important for all clarifier types. For DAF units, desludging should also occur regularly to prevent sludge re-settling. The sludge in this process is exposed, so it is important that the tanks are covered to prevent the rain and wind affecting performance.

Buoyant media clarifiers need to be backwashed when the media becomes clogged, again to prevent excessive floc carry-over to the downstream filtration step.

Growth of algae and slimes on the walls of sedimentation tanks and other channels should be discouraged. Regular cleaning is recommended, because such material can increase the levels of dissolved organic matter that the plant must contend with, and can contribute to taste and odour problems.

## 13.6 Lime softening and ion exchange

Water containing significant concentrations of calcium and magnesium is referred to as hard water. Hard water can cause scaling of pipes and household appliances and reduces the solubility of soaps and detergents in the water.

Lime softening and ion exchange processes can be used to soften water, however both are currently of limited use in New Zealand for drinking-water, mainly because, on average, New Zealand waters are softer than those found in many other parts of the world.

### 13.6.1 Lime softening

The lime softening process removes hardness by chemical precipitation, followed by sedimentation and filtration, therefore showing similarities to the conventional chemical clarification process. Lime, caustic soda (sodium hydroxide) or soda ash is added to the water, increasing the pH, which causes the metal ions to flocculate and precipitate. The metal precipitates are removed during the sedimentation stage, prior

to filtration. Other contaminants may also combine with the precipitates and be removed by this process.

Calcium concentrations can be reduced at pH 9.5 to 10.5 in lime softening processes, although magnesium requires pH 10.5 to 11.5. Several organisms are inactivated at the latter pH; see WHO (2004a) for further information. The microbial treatment mechanism of this process is a combination of inactivation due to elevated pH levels, and removal by sedimentation. However, *Cryptosporidium* and *Giardia* are not inactivated by high pH levels. Removal of protozoa through this process is solely due to the sedimentation and subsequent filtration. Section 5.4 of the DWSNZ specifies the compliance criteria that need to be satisfied in order to qualify for 3 log credits.

A single stage lime softening plant consists of a primary clarifier and filtration step. An additional clarifier is required between the primary clarifier and the filtration step for two-stage lime softening. A coagulant is added to both stages of clarification. Two-stage lime softening can provide additional *Cryptosporidium* removal due to the additional sedimentation stage within the process. Refer also to Chapter 6 of the review draft LT2ESWTR Toolbox Guidance Manual (USEPA 2009) which discusses issues related to lime softening.

## 13.6.2 Ion exchange

Ion exchange is discussed in this section because it is used frequently to soften water; it is not a coagulation process, and does not earn protozoal log credits. Many aspects of ion exchange are covered in NSF/ANSI 44-2004.

Ion exchange treatment units can be cationic, anionic, weakly or strongly ionic, or mixed bed, depending on the reason for its use.

Mixed bed units are employed for producing deionised water, usually for laboratories and industry. WHO (2005) also discusses some negative aspects of drinking deionised, distilled or reverse osmosis water, due to their tastelessness, and loss of essential minerals, mainly calcium and magnesium. This is discussed briefly in Chapter 10: Chemical Compliance, section 10.2.2.

Cationic beds can be used to remove calcium from the water, usually replacing it with sodium; if iron and manganese exist in the water in the soluble state (ie, ionic) their concentrations can be reduced as well. The process needs to be monitored to determine when the resin needs recharging. Some smaller units use a colour indicator for this purpose.

Strong-base anion exchange can be used to reduce the concentration of arsenic in the form of soluble arsenite or arsenate. This process replaces most anions in the water, usually with chloride ions, which can make the water corrosive.

There are currently two approaches to nitrate removal. One is as described in the previous paragraph, where all anions are replaced with chloride. Since anion exchange resins are generally more selective for sulphate over nitrate, the capacity of a resin for nitrate removal will be limited by the concentration of sulphate. The other approach is to use a nitrate selective resin, usually reducing nitrate to less than 2 mg/L as N.

WHO (2004a) describes ion exchange as follows:

Ion exchange is a treatment process in which a solid phase presaturant ion is exchanged for an unwanted ion in the untreated water. The process is used for water softening (removal of calcium and magnesium), removal of some radionuclides (eg, radium and barium) and removal of various other contaminants (eg, nitrate, arsenate, chromate, selenate and dissolved organic carbon). The effectiveness of the process depends on the background water quality, and the levels of other competing ions and total dissolved solids. Although some ion exchange systems can be effective for adsorbing viruses and bacteria, such systems are not generally considered a microbial treatment barrier, because the organisms can be released from the resin by competing ions and flow changes. Also, ion exchange resins may become colonised by bacteria, which can then contaminate treated effluents. Backflushing and other rinsing procedures, even regeneration, will not remove all of the attached microbes. Impregnation of the resin with silver suppresses bacterial growth initially, but eventually a silver-tolerant population develops. Disinfection of ion exchange resins using 0.01 percent peracetic acid (one-hour contact time) has been suggested.

As explained in the previous paragraph, ion exchange cannot be relied upon to consistently remove (oo)cysts from water, hence does not qualify for protozoal log credits. Ion exchange resins have been developed that can reduce the concentration of natural organic matter, eg, as used in Orica's (now IXOM's) MIEX (magnetised anion exchange resin) process. The MIEX<sup>®</sup> Process uses a fluidised bed ion exchange reactor to remove dissolved organic carbon. This process can be used upstream of a conventional chemical coagulation plant that has difficulty in complying with the criteria in section 5.4 of the DWSNZ. Although this ion exchange process does not qualify for log credits on its own, it may well be possible for the whole process to earn 3 log credits (section 5.4), or 3.5 (section 5.4 plus 5.7), or even 4 log credits (section 5.4 plus 5.8). The use of ion exchange resins that reduce the concentration of natural organic matter may offer the additional advantage of reducing the concentration of disinfection by-product precursors sufficiently to avoid monitoring for, or removing, DBPs. MIEX may also reduce the natural organic matter sufficiently from water with a low UVT (high UV absorbance) to render UV disinfection economic.

Ion exchange is discussed in Chapter 9 of AWWA (1990).

# 13.7 Rapid granular media filtration

## 13.7.1 Overview

Rapid granular media filtration, as illustrated in Figure 13.7, provides the conventional polishing step following coagulation and sedimentation, and is the only floc removal/polishing step in direct filtration plants. It is the most common type of filtration used in New Zealand water treatment plants. The filter may operate by gravity or pressure. Other filtration processes not generally used in conjunction with coagulation are discussed separately in Chapter 14: Treatment Processes, Filtration. WHO (2004a) discusses some design, operation and performance aspects of granular media filtration. Refer also to Chapter 7 of the review draft LT2ESWTR Toolbox Guidance Manual (USEPA 2009) which discusses issues related to filtration, including enhanced individual and combined filtration.

**Figure 13.7: Rapid granular media filter**

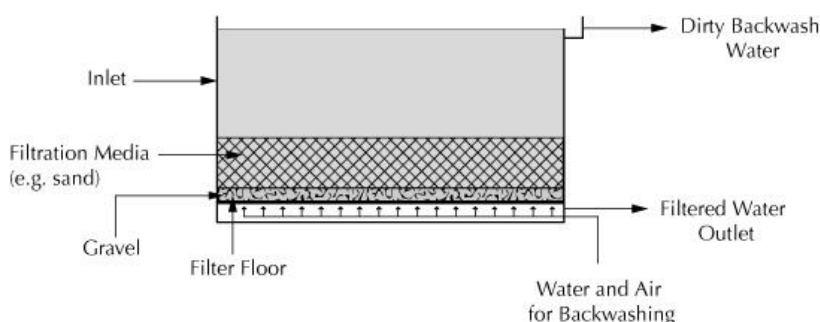

Like clarifiers, filters can be described by their treatment rate. This is usually expressed as  $\text{m}^3/\text{m}^2/\text{h}$  (more correctly  $\text{m}^3/\text{m}^2\cdot\text{h}$  or  $\text{m}/\text{h}$ ) and is the flowrate ( $\text{m}^3/\text{h}$ ) that occurs over the surface area ( $\text{m}^2$ ) of the filter bed. Filtration rates are also measured as  $\text{mm}/\text{s}$ .

Older filters were designed to operate at around 5  $\text{m}/\text{h}$  (1.4  $\text{mm}/\text{s}$ ). However, many modern filters and dual media filters will operate at higher filtration rates of 10–15  $\text{m}/\text{h}$  (2.8–4.2  $\text{mm}/\text{s}$ ), especially if the coagulant is assisted with polyelectrolyte.

As water passes through a filter bed of media, particulate matter (including micro-organisms) is trapped within the media primarily by a two-step process in which particles are moved to the surfaces of media grains or previously captured floc, and then become attached (adsorbed) to these surfaces. Physical straining is only a minor factor in rapid granular filtration.

The particles that build up in the bed are subsequently removed by backwashing at regular intervals. Traditionally, single medium sand filters of shallow depth (typically between 600 and 750 mm excluding the support gravel) were the most common. However, newer plants often contain dual media, either anthracite or thermally modified pumice (silicon sponge) over sand, or coarse medium deep bed with typical total media depths of between 1.2 and 1.5 m. For further information on these newer media refer to Kawamura (2000), and for pumice (or porous ceramic dual media) filters refer to Hill and Langdon (1991).

The concept of dual or multimedia filters is to include a relatively coarse medium (eg, anthracite) on the top, followed by finer media beneath. This causes deeper penetration of the particles being removed, allowing longer filter runs. Some multimedia filters use a very fine medium at the bottom of the bed (eg, garnet); this allows finer particles to be trapped but increases the headloss. The effectiveness of multimedia filters depends on the media remaining separate even after multiple backwashes. This is achieved by a balance between the relative densities of each filter medium and the backwashing conditions. Depending on the nature of the particles being removed, multimedia filters may be effective without using coagulation.

By using a polyelectrolyte as a coagulant aid or filter aid, the strength or 'stickiness' of the attachment between the floc particles and the media grains is increased, allowing higher filtration rates and coarser media gradings to be used thereby reducing the rate that headloss increases. It also means the filter is less likely to let go of these particles following flow increases or surges.

If too much polyelectrolyte is dosed, the particles will adsorb to sand grains at the top of the filter, causing the headloss to increase too quickly; excessive polyelectrolyte dosage may also cause backwash problems. At a more appropriate polyelectrolyte dose, the particles penetrate further into the bed, making more use of the full depth of the media, and allowing much longer filter runs. If the polyelectrolyte dose is too low, many of the particles may pass through the bed if the filter grains are coarse or the filtration rate too high. Bed penetration can be assessed by measuring the headloss at various depths through the filter.

Before the introduction of polyelectrolytes, filter sand was usually in the 0.6 to 1.2 mm diameter range, that is, in the 14/25 sieve range. Using such fine sand was considered necessary to strain out the particles. Using polyelectrolytes enables use of coarser sand, such as in the 2 to 4 mm range. The advantages include less headloss, and deeper penetration thereby using more of the bed leading to longer filter runs.

Rapid granular filters can be operated at either a constant rate of flow (constant rate filtration) or at a flow rate that declines as headloss builds up during a filter run (declining rate filtration). Constant rate filtration is the more common method and is normally achieved by the control valve on the filter outlet opening progressively during a filter run to compensate for the build-up of headloss through the bed.

Water treatment plants may not be able to remove all the soluble manganese. One technique that is used to enhance manganese removal is to use greensand filters; apparently with varying degrees of success. ANSI/AWWA Standard B102-10 is titled Manganese Greensand for Filters.

Backwashing is the term used to describe the cleaning of the filter by passing water (often preceded by, and/or in combination with, air) in the reverse flow direction to when the filter is in normal operation. Similarly to the term filtration rate, the term backwash rate in m/h (or mm/s) is used to describe the intensity of the backwash operation. Traditionally in New Zealand, backwash rates were low (typically 20–25 m/h), preceded by an air scour at a similar rate. There are a variety of systems in use including air scour followed by water backwash, water only, and combined air/water followed by water backwash. Modern best practice is a combined air scour/low rate water backwash (the optimal regime is known as collapse pulsing), followed by a high

rate water backwash (as high as 55 m/h). A bed expansion of 20 percent is the objective during the high-rate backwash to ensure full bed fluidisation and adequate cleaning. Note that to achieve the same degree of bed expansion will require higher flow rates in summer compared with winter, as warmer water has a lower viscosity than cold, and the effects of this should be considered in backwash design.

## 13.7.2 Turbidity monitoring

Turbidity measurement is used to assess the efficiency of the filter in achieving protozoa removal for compliance with DWSNZ. Sampling must be made on water directly from the filtration process. The DWSNZ require turbidity monitoring of each filter (unless the population served is below a threshold value – see Table 5.3 of DWSNZ). Particle counters can also be used to measure and optimise filter performance, but these are not required for compliance purposes.

Although turbidimeters are not required on individual filters at smaller plants, their use is strongly encouraged. This is because when measuring a combined effluent from multiple filters, one filter may be producing poor quality water that is then diluted by good quality water from the other filters and the sub-standard filter's performance would not be noticed. Continuously monitoring each filter will indicate whether any slow start mechanism, filter-to-waste, the headloss control, filter run length, filtration rate control, and filter cleaning are operating or selected correctly.

To earn 3 log credits under DWSNZ for protozoa removal using the coagulation, sedimentation, filtration process, or 2.5 log credits for direct filtration, one of the requirements is that the filtrate from each filter must be less than 0.30 NTU for at least 95 percent of the time (DWSNZ, sections 5.4 and 5.5).

Additional log credits are available for enhanced filtration, ie, individual filter effluent (IFE) monitoring and combined filter effluent (CFE) monitoring, see Chapter 8: Protozoa Compliance. These will usually be the standard rapid granular media filters, but producing a lower turbidity filtrate. The standard tungsten lamp type nephelometer may not be sensitive enough at such low NTUs; a laser turbidimeter may be required. Turbidity measurement and calibration is discussed in Chapter 8: Protozoa Compliance, section 8.6.2.

## 13.7.3 Filter operation

As solids build up through the bed, headloss across the bed will increase and at some stage filtrate turbidity will also increase. Backwashing frequency can therefore be triggered by headloss, turbidity or filter run times (based on operational experience). The filter goes through a ripening period when it is brought back online, during which time the filtrate quality will be substandard. For this reason slow-start, delayed starts, and filter-to-waste are becoming common practice.



## 13.7.4 Optimisation of the filtration process

Increased filtrate turbidity (or residual coagulant, eg, aluminium or iron) is the primary indication of problems with a filter, however reduced run times (caused by turbidity or headloss reaching the set point earlier than usual) can also highlight problems.

Raw water that has high colour and low turbidity (and typically with low alkalinity) can be very difficult to treat, particularly when the water is less than say 10°C. The floc often only forms in a narrow range of alum dose and pH conditions. It is usually small, slow to form, and light, so that it is very susceptible to shear due to flow changes. It can even be difficult to see. Removal of protozoa in these conditions will be sub-optimal. These waters can also result in elevated aluminium levels in the filtered water, and hence additional attention should be paid to monitoring filtered water aluminium.

If filtrate turbidity increases are observed across all the filters, there is likely to be a common problem upstream of the filters. The following are some possible causes of high turbidity in the filtered water:

- non-optimal coagulant dosing may cause poor floc formation, which can overload and/or pass through the filters; this can be caused by selection of an inappropriate alum dose, raw water alkalinity too low for the alum dose rate being used, or coagulation occurring at the wrong pH
- operational problems such as the alum solution being the wrong strength (or even run out!), or the automatic adjustment to flow rate being faulty, or inadequate sludge removal from the settling tanks
- dose pumps not performing to specification; a good practice is to check the pump discharge against the dose setting (sometimes called the stroke), for example, by using dose timers, or calculating from the weight used while a measured flow has been treated
- flowrates may have been increased too rapidly, causing sludge blanket instability
- floc carry-over from a poor clarification process will increase the solids loading on to the filters, reducing run times and causing excessive backwashing
- insufficient polyelectrolyte for the conditions, causing sludge blanket instability
- excessive polyelectrolyte dosing, which can quickly blind the filter and reduce filter runs, thereby causing the filtered water turbidity to increase earlier than expected
- flow increasing excessively through the remaining filters when one is being washed
- direct filtration, being a one-step process, is particularly susceptible to sudden changes in raw water quality and flowrate.

If filtered water turbidity is high on a single filter, the problem is likely to reside only with that filter. Some problems, their consequences, and potential indicators are listed below:

- backwash/air scour flowrates too low resulting in a partially washed filter being put back into service
- backwash/air scour flowrates too high resulting in loss of sand, allowing particles to pass through the shallower bed

- insufficient duration of washing, also resulting in a partially washed filter being put back into service; an elevated clean bed headloss (above normal values) on start-up immediately after a backwash is a good indication that insufficient backwashing has occurred
- failed or blocked backwash nozzles or underdrain system. This situation results in excessive filtration rates and backwash flows through that part of the filter bed that is still in operation. Observing a filter during a wash can assist in detecting individual failed nozzles: the overall water or air distribution pattern during the wash will be uneven
- filter flow meter, controller, or filtration rate indicator may be out of calibration
- uneven flow split to each filter may cause reduced filter run times for some filters and excessive flows to others. Inlet pipe or channel configurations should be checked.

If filter runs are longer than expected, they may not be due to improved quality of the water feeding the filters. They can result from:

- backwash/air scour flow rates being too high or the duration too long. Over-washing may lead to media loss (thus reducing media depth in the filter), or impairment of the media's ability to adsorb particles. Checking and recording the media depth at regular intervals can highlight if media is being lost due to over washing
- if the alum dose is incorrect, or raw water alkalinity too low for the alum dose rate being used, minimal floc may be forming, reducing the solids loading on the filter, thereby increasing filter run times. Protozoa removal will be sub-optimal
- polyelectrolyte dosage is important, particularly in high rate or coarse-grained filters. As mentioned above, too much polyelectrolyte can blind the filter, but too little polyelectrolyte can result in some floc passing through the bed
- plants treating raw water with a low turbidity and average to high natural organic matter, often using direct filtration, may produce filtered water with a low turbidity despite very little of the aluminium being removed. A slower than usual increase in headloss indicates a low removal rate of particulate matter. Plants treating raw water like that should test for aluminium in the final water to check that the process is operating satisfactorily.

Sudden flow changes can cause problems with filtrate quality, eg, when:

- filters are taken out of service, as there will be a corresponding flow increase to the other filters. Allowing only gradual flow changes during this operation, rather than a sudden change, will minimise these effects
- poor flow control at the outlet from the filter typically caused by incorrect valve and/or actuator selection
- inadequate storage of treated water can require sudden increases in flow through the plant which will challenge the whole treatment process.

Monitoring the raw water quality, optimisation of the coagulation and clarification processes, and good operating procedures can minimise these effects.

Other common problems with granular media filters include bed cracking, shrinkage of the media away from the walls, mudballing, and the media in multimedia beds intermixing. These are generally caused by excessive clarifier effluent turbidity, dosing polyelectrolyte too high, poor filter backwash/air scour capability, or excessive filtration rates for the filter type, and can usually be checked by visually assessing or sampling the media.

Mudballing problems (ie, sand particles sticking together) can be alleviated by using high pressure sparge cleaning and/or acid, chlorine or caustic soda washing to break up the mud balls. Often there is a more fundamental problem that needs to be addressed to solve the problem long term, such as inadequate filter backwashing that may require significant upgrading of the filters.

A quick checklist that can be used if the turbidity of a filter effluent exceeds the required or normal level is as follows; determine whether:

- the raw water quality changed
- the solids loading on the filters increased
- the coagulant dose was selected correctly
- the coagulant is being dosed correctly
- the coagulation pH is optimum
- all the alkalinity has been neutralised
- polyelectrolyte is needed or is being dosed correctly
- the turbidity excursions occur at the same time of day or season (eg, algal problems)
- one or more of the filters is responsible
- the filter-to-waste period should be extended
- the filters are receiving unequal flows
- the backwash and air scour flows and pressures are correct
- parts of the bed are mudballed (blocked), causing uneven filtration rates
- the filter beds are cracked or shrinking away from the walls
- excessive sand loss has reduced the media depth
- the filter rate is excessive for the type of filter
- the problem only occurs when 'a certain' operator is on duty.

If the filtered water turbidity readings tend to produce spikes, check whether:

- all filters are responsible
- the filters are returning to service too soon after a wash
- the slow start mechanism is operating correctly
- a filter run was excessive
- the state of the filter bed and underdrainage system cause poor backwashing
- the headloss instruments or flow controllers are inaccurate
- the treatment plant output increased too much or too rapidly

- the flow balancing system is operating correctly (eg, when a filter is taken out of service for washing)
- the filter outlet valve is modulating smoothly enough
- more polyelectrolyte is needed to cope with short periods of high flow
- it happens at the same time as something else (eg, when pump settings or valves are altered or when the washwater is returned).

For further reading, try USEPA (1999). Section 4.2 deals with system evaluation and plant optimisation, section 5 deals with individual filter self-assessment, and section 6 with comprehensive performance evaluation.

WHO (2001) covers a lot of ground too.

## 13.8 Second stage filtration

Secondary filtration is a process whereby an entirely separate rapid granular filter box or vessel is used as a second filtration stage following a first stage filter (ie, two separate filters used in series).

To qualify for additional log credits, coagulation must have taken place before the first stage filter, which may contain a coarse medium, followed by the secondary filtration stage that is typically a conventional dual or multimedia filter. Additional coagulants (or more commonly) filter aids (polyelectrolytes), or oxidants can be added between the first and second stages.

Some reasons for using two-stage filtration include:

- following direct filtration if the raw water quality is variable and the option is cheaper than building sedimentation tanks
- where the treatment plant occasionally experiences periods of stress, eg:
  - when very cold winter water causes aluminium flocs to form slowly
  - or during high summer flows
- to remove iron and manganese after an oxidation stage, eg, after chlorination
- to remove grit from poor quality lime. At this elevated pH, more iron and manganese may be removed too
- to remove further organic matter, including any disinfection by-products, by using granular activated carbon (GAC) filters or biologically activated carbon (BAC) filters.

Complying with section 5.4: Coagulation, sedimentation and filtration processes earns 3 log credits. Complying with section 5.5: Coagulation, direct filtration: treatment earns 2.5 log credits. Secondary filtration may earn an additional 0.5 log credit for protozoal compliance, refer DWSNZ, section 5.6.

The secondary stage filters must involve the use of a rapid sand, dual media, granular activated carbon (GAC or BAC), or other fine grain media unit process applied in a separate stage following rapid granular or dual media filtration. To qualify, a continuous chemical coagulation process must be in operation upstream of the first filters. One of the monitoring requirements is that the turbidity of the water leaving the secondary filters must not exceed 0.15 NTU for more than 5 percent of the time, see section 5.6.1 of the DWSNZ. See also USEPA (2003), and Chapter 9 of the review draft LT2ESWTR Toolbox Guidance Manual (USEPA 2009) which discusses issues related to second stage filtration.

Sometimes the coagulation process is followed by membrane filtration. In this situation, a second stage filter cannot earn additional log credits. The main reason is that water that has passed through a very fine filter should not earn any more log credits for passing through a much coarser filter. A compliant membrane filter will already be producing water with a turbidity less than 0.10 NTU, so it is not logical to earn more log credits for producing water that could have a higher turbidity!

## References

- ANSI/AWWA B100-09. *AWWA Standard for Granular Filter Material* (2/6/2009).
- ANSI/AWWA B102-10. *AWWA Standard for Manganese Greensand for Filters*.
- AWWA. 1990. *Water Quality and Treatment* (4th edition). McGraw-Hill Inc.
- AWWA. 2000. *Operational Control of Coagulation and Filtration Processes*. Manual M37 (2nd edition). Denver CO: American Water Works Association.
- Dugan N, Fox K, Owens J, et al. 2001. Controlling *Cryptosporidium* oocysts using conventional treatment. *J AWWA* 93(12): 64–76.
- Drinking Water Inspectorate (DWI). 2011. *List of Approved Products for Use in Public Water Supply in the United Kingdom*. London: Department for Environment, Food and Rural Affairs. See [www.dwi.gov.uk](http://www.dwi.gov.uk) or <http://dwi.defra.gov.uk/drinking-water-products/approved-products/soslistcurrent.pdf>.
- DWI. 2013. *Potential Contaminants in Drinking Water Treatment Chemicals: Final Report*. WRc Ref: Defra9033.03. 129 pp. <http://dwi.defra.gov.uk/research/completed-research/reports/DWI70-2-272.pdf> or <http://dwi.defra.gov.uk/>.
- Hill T, Langdon A. 1991. Porous ceramic dual media filtration. *Water & Wastes in New Zealand* 66(July): 19–20, 22.
- Kawamura S. 2000. *Integrated Design and Operation of Water Treatment Facilities* (2nd edition). New York: John Wiley & Sons.
- The New Zealand Ministry of Health's Guides for drinking-water supplies can be accessed as Word documents on the Ministry of Health website: <http://www.health.govt.nz/water> then select publications and Water Safety Plans.

Ministry of Health. *Public Health Risk Management Plan Guide PHRMP Ref. P5.1. Treatment Processes – Coagulation/Flocculation/Sedimentation*. Wellington: Ministry of Health.

Ministry of Health. *Public Health Risk Management Plan Guide PHRMP Ref. P5.2. Treatment Processes – Dissolved Air Flotation*. Wellington: Ministry of Health.

Ministry of Health. *Public Health Risk Management Plan Guide PHRMP Ref. P5.3. Treatment Processes – Direct Filtration*. Wellington: Ministry of Health.

Ministry of Health. *Public Health Risk Management Plan Guide PHRMP Ref. P6.1. Treatment Processes – Rapid Sand Filtration*. Wellington: Ministry of Health.

Ministry of Health. *Public Health Risk Management Plan Guide PHRMP Ref. P8.1. Treatment Processes – pH Adjustment*. Wellington: Ministry of Health.

Ministry of Health. *Public Health Risk Management Plan Guide PHRMP Ref. P11. Treatment Processes – Plant Construction and Operation*. Wellington: Ministry of Health.

Ministry of Health. 2005. *Drinking-water Standards for New Zealand 2005, revised 2008*. Wellington: Ministry of Health.

NSF/ANSI 44-2004. Updated 2007. *Residential Cation Exchange Water Softeners*. Ann Arbor, Michigan: NSF International.

NZWWA. 1997. *Standard for the Supply of Aluminium Sulphate for Use in Water Treatment* (2nd edition). New Zealand Water and Wastes Association. Revised 2012.

NZWWA. 1999. *Standard for the Supply of Polyacrylamides for Use in Drinking-water Treatment*, ISBN 1-877134-24-4. New Zealand Water and Wastes Association.

NZWWA. 1999. *Standard for the Supply of Polydadmac for Use in Drinking-water Treatment*, ISBN 1-877134-25-2. New Zealand Water and Wastes Association.

NZWWA. 1999. *Standard for the Supply of Epi-DMA Polyamines for Use in Drinking-water Treatment*, ISBN 1-877134-26-0. New Zealand Water and Wastes Association.

NZWWA. 2013. *Standard for the Supply of Polyaluminium Chloride for Use in Water Treatment* (2nd edition). ISBN 1-877134-08-2. [www.waternz.org.nz](http://www.waternz.org.nz).

Ogilvie D. 1998. Streaming current detection. *Water & Wastes in NZ* 101 (July): 32, 34–35.

Srinivasan PT, Viraraghavan T, Subramanian KS. 1999. Aluminium in drinking water: an overview. *Water SA* 25(1, January): 47–55.

USEPA. 1999. *Guidance Manual for Compliance with the Interim Enhanced Surface Water Treatment Rule: Turbidity provisions*. Report EPA 815-R-99-010. <http://water.epa.gov/lawsregs/rulesregs/sdwa/mdbp/mdbptg.cfm>.

US Partnership for Safe Water Guidelines for Phase IV. *Excellence in Water Treatment*. See information on this subject at: <http://www.docstoc.com/docs/132750163/Partnership-for-Safe-Water-American-Water-Works-Association>.

USEPA. 2007. *Simultaneous Compliance Guidance Manual for the Long Term 2 and Stage 2 DBP Rules*. EPA 815-R-07-017. 462 pp.  
<http://water.epa.gov/lawsregs/rulesregs/sdwa/stage2/compliance.cfm> or  
[http://water.epa.gov/lawsregs/rulesregs/sdwa/lcr/upload/2007\\_5\\_10\\_disinfection\\_stage2\\_guide\\_st2\\_pws\\_simultaneous-compliance.pdf](http://water.epa.gov/lawsregs/rulesregs/sdwa/lcr/upload/2007_5_10_disinfection_stage2_guide_st2_pws_simultaneous-compliance.pdf).

USEPA. 2009. *Long Term 2 Enhanced Surface Water Treatment Rule, Toolbox Guidance Manual Review Draft*. Go into <http://www.epa.gov/safewater/disinfection/lt2/> and then enter: toolbox guidance manual review draft in the 'search' box. See USEPA (2010) for Final.

USEPA. 2010. *Long Term 2 Enhanced Surface Water Treatment Rule, Toolbox Guidance Manual*. EPA-815-R-09-016. 375 pp.  
[http://www.epa.gov/safewater/disinfection/lt2/pdfs/guide\\_lt2\\_toolboxguidance\\_manual.pdf](http://www.epa.gov/safewater/disinfection/lt2/pdfs/guide_lt2_toolboxguidance_manual.pdf).

WHO. 2001. *Upgrading Water Treatment Plants*. ISBN 0 419 26050 1. Published on behalf of WHO by Spon Press, London. Available on the internet at:  
[http://www.who.int/water\\_sanitation\\_health/hygiene/om/treatplants/en/index.html](http://www.who.int/water_sanitation_health/hygiene/om/treatplants/en/index.html).

WHO. 2004. *Guidelines for Drinking-water Quality 2004* (3rd edition). Geneva: World Health Organization. Available at:  
[www.who.int/water\\_sanitation\\_health/dwq/gdwq3/en/print.html](http://www.who.int/water_sanitation_health/dwq/gdwq3/en/print.html) see also the addenda.

WHO. 2004a. *Water Treatment and Pathogen Control: Process efficiency in achieving safe drinking water*. MW LeChevallier, K-K Au. IWA Publishing. 136 pp. Available at:  
[www.who.int/water\\_sanitation\\_health/publications/en/index.html](http://www.who.int/water_sanitation_health/publications/en/index.html).

WHO. 2011. *Guidelines for Drinking-water Quality 2011* (4th edition). Geneva: World Health Organization. Available at:  
[http://www.who.int/water\\_sanitation\\_health/publications/2011/dwq\\_guidelines/en/index.html](http://www.who.int/water_sanitation_health/publications/2011/dwq_guidelines/en/index.html).

WHO. 2017. *Guidelines for Drinking-water Quality: Fourth edition incorporating the first Addendum*. Geneva: World Health Organization. 631 pp.  
[http://www.who.int/water\\_sanitation\\_health/publications/drinking-water-quality-guidelines-4-including-1st-addendum/en/](http://www.who.int/water_sanitation_health/publications/drinking-water-quality-guidelines-4-including-1st-addendum/en/).

# Chapter 14: Treatment processes, filtration and adsorption

## Contents

|             |   |           |
|-------------|---|-----------|
| <b>14.1</b> | <b>Introduction</b>                             | <b>2</b>  |
| <b>14.2</b> | <b>Diatomaceous earth filtration</b>            | <b>4</b>  |
| 14.2.1      | Vacuum or standard DE filtration                | 5         |
| 14.2.2      | Pressure or modified DE filtration              | 6         |
| 14.2.3      | Some operating issues with DE filtration        | 7         |
| 14.2.4      | Monitoring                                      | 7         |
| <b>14.3</b> | <b>Slow sand filtration</b>                     | <b>7</b>  |
| 14.3.1      | Cleaning  | 9         |
| 14.3.2      | Monitoring                                      | 10        |
| 14.3.3      | Aeration  | 11        |
| 14.3.4      | Some operating issues with slow sand filtration | 11        |
| <b>14.4</b> | <b>Membrane filtration</b>                      | <b>12</b> |
| 14.4.1      | Introduction                                    | 12        |
| 14.4.2      | Current experience in New Zealand and overseas  | 13        |
| 14.4.3      | Fundamentals of membrane filtration             | 13        |
| 14.4.4      | Membrane selection                              | 16        |
| 14.4.5      | Membrane plant operations                       | 18        |
| <b>14.5</b> | <b>Cartridge filtration</b>                     | <b>26</b> |
| <b>14.6</b> | <b>Bag filtration</b>                           | <b>33</b> |
| <b>14.7</b> | <b>Adsorption processes</b>                     | <b>35</b> |
| 14.7.1      | Activated alumina                               | 35        |
| 14.7.2      | Solid block activated carbon (SBAC) filters     | 36        |
| 14.7.3      | Granular activated carbon (GAC) filters         | 37        |
| 14.7.4      | Biologically active filters (BAC)               | 37        |



|                          |           |
|--------------------------|-----------|
| <b>14.8 Desalination</b> | <b>38</b> |
|--------------------------|-----------|

|                   |           |
|-------------------|-----------|
| <b>References</b> | <b>40</b> |
|-------------------|-----------|

### List of tables

|   |    |
|---|----|
| Table 14.1: Properties of typical membrane materials                            | 17 |
| Table 14.2: Typical design/operating criteria for MF/UF systems (guidance only) | 24 |
| Table 14.3: Data log and check sheet  | 25 |
| Table 14.4: Chemical cleaning log sheet – provided by membrane supplier         | 25 |

### List of figures

|  |    |
|--|----|
| Figure 14.1: Diatomaceous earth pressure plant at Mokau, Waitomo District                      | 6  |
| Figure 14.2: Typical submerged membrane system   | 15 |
| Figure 14.3: Cutaway showing cartridge seal  | 29 |
| Figure 14.4: Suggested arrangement for reading pressure differential across a cartridge filter | 30 |
| Figure 14.5: Typical pressure drop across a cartridge during a filter run                      | 31 |

## 14.1 Introduction

Chapter 13 discusses issues relating to the operation of water treatment plants using a chemical coagulant such as alum or polyaluminium chloride followed by rapid granular media filtration. This process may also include sedimentation (ie, clarification) or dissolved air flotation. Filters following coagulation processes operate mainly by adsorption processes rather than straining or entrapment. Chapter 13 also briefly describes water softening using lime (followed by sand filtration) because it is a process that the USEPA and the DWSNZ considers capable of removing protozoa.

This chapter discusses diatomaceous earth filtration, slow sand filtration, membrane filtration, cartridge filtration, and bag filtration. These are the other water treatment processes that can remove *Cryptosporidium* oocysts effectively enough to be considered for protozoa log credits. Their filtration process operates by straining or entrapment.

This chapter also discusses adsorption processes that do not need to follow coagulation processes. These can remove some of the chemical determinands with MAVs. Adsorption processes are also discussed in Chapter 18 with reference to taste and odour control, and in Chapter 19, mainly related to point-of-use and point-of-entry treatment systems. Activated carbon is also mentioned throughout Chapter 9, as a means of adsorbing cyanotoxins from water.

No other filtration processes are discussed in this chapter. Chapter 12, on pretreatment processes, includes some commentary on screens and other coarse filtering processes. These do not qualify for any protozoa log credits.

The 2008 DWSNZ include a new section, section 5.17: Alternative processes: treatment compliance criteria, whereby water suppliers may apply to the Ministry of Health to have other treatment processes assessed for a log credit rating. This approach, which is explained more fully in section 8.4.5 of the Guidelines, allows water suppliers to apply for a log credit rating (or a variation to the prescribed log credits) for a treatment plant or process:

- a) not covered in sections 5.1–5.16 of the DWSNZ
- b) that performs demonstrably better than its compliance criteria
- c) that performs to a lesser, but reliable, level than specified in its compliance criteria.

This chapter concentrates on the operations and management of the processes; Chapter 8 discusses their compliance issues with respect to protozoa removal.

The bag and cartridge filtration sections have been expanded because they are being used more often since when the 1995 Guidelines were produced, and because more experience has been accumulated in recent years regarding their use.

The membrane filtration section in the 1995 edition of the Guidelines was just one paragraph. Technological advances have resulted in the process being used much more often today. Consequently, this section is now quite large.

The other treatments, slow sand and diatomaceous earth filtration, have been expanded because they may be attractive processes for smaller supplies for protozoa removal.

Some process variation is normal and expected; however, too much variability can result in filtration failures, leading to waterborne disease outbreaks. An objective of the DWSNZ, therefore, is to keep process variability within acceptable limits. Understanding the causes of process variations should prevent recurrences. An important design feature is to include sufficient final water storage so the water treatment rate is as near constant as possible; plant using stop/start should be avoided whenever possible.

The AWWA has produced manuals on precoat filtration and on reverse osmosis/nanofiltration, see references. The full list of AWWA manuals and standards appears on <http://www.awwa.org/files/Resources/Standards/StandardsSpreadsheet.xls>.

Risk management issues related to the filtration processes in this chapter are discussed in the:

- MoH Public Health Risk Management Plan Guide PHRMP, Ref: P6.2. Filtration – Slow Sand Filtration
- MoH Public Health Risk Management Plan Guide PHRMP, Ref: P6.3. Treatment Processes – Cartridge Filtration
- MoH Public Health Risk Management Plan Guide PHRMP, Ref: 6.4. Filtration – Diatomaceous Earth

- MoH Public Health Risk Management Plan Guide PHRMP, Ref: P6.5. Treatment Processes – Membrane
- MoH Public Health Risk Management Plan Guide PHRMP, Ref: P10. Treatment Processes – Pump Operation
- MoH Public Health Risk Management Plan Guide PHRMP, Ref: P11. Treatment Processes – Plant Construction and Operation.

DWI (2011) has prepared a list of products that are approved for use in UK water supplies.

A section on desalination has been added because this chapter appears to be the most appropriate. Desalination is not used yet in New Zealand, and has not been considered directly for protozoal compliance.

## 14.2 Diatomaceous earth filtration

Diatomaceous earth filtration uses a mobile material to build up a filter wall on a membrane. Diatomaceous earth (DE) is a fine, powdery substance comprising the skeletons of diatoms (microscopic algae). It occurs as natural deposits, which are mined, dried, graded and bagged. The usual source is the USA.

DE has been used in New Zealand commonly for swimming pool filtration and in the food industry; for example, most breweries use it to ensure that no yeast is carried over. DE filtration does not remove much colloidal colour or soluble organic matter. These materials are too small to be captured by the mechanical filtration process of DE. They require much finer filtration, or coagulation to allow them to be agglomerated into a floc. DE filtration is mainly used to treat clean stream waters and springs and is accepted in the DWSNZ (Ministry of Health 2005, revised 2008) as being capable of earning 2.5 log credits for protozoa removal.

As at 2005, four water supplies (Ohakune, Woodville, Mokau and Benneydale) have been using a DE process for municipal supply. Bonny and Cameron (1998) described the Woodville plant.

The DE material varies in size. Larger diameter material causes less headloss through the filter layer but offers less protection against protozoal (oo)cysts or other particulate matter. ANSI/AWWA B101-12 covers precoat filter media.

Typically, the finer DE material is around 15–20 microns median size and the coarser material is around 35–40 microns. Both contain a wide range of sizes, but the uniformity coefficient is normally about 5. The uniformity coefficient, or UC, is the ratio between the material's  $d_{60}$  and its  $d_{10}$  with the  $d_{60}$  being the particle size that 60 percent of the material is smaller than, and  $d_{10}$  having a corresponding meaning. The pore sizes (the holes between the DE particles) range from about 5 to about 12 microns. The DWSNZ do not specify a maximum median size; compliance is based on performance, as measured by turbidity. Ogilvie (1998) described diatomaceous earth and its use in filtration.

Ongerth and Hutton (1997) found that at least 3 log removal of *Cryptosporidium* was achieved using the coarser media at low flow rates (2.4 m/h). Finer media and higher flow rates (4.9 m/h) improved the results to around 6 log. The improved filtration at higher filtration rates is due to compression of the filter cake. Local practice is to operate at about 4.3 m/h using DE that is rated to remove particles down to 1.2 microns.

WHO (2004a) calls this process 'precoat filtration', and reports some interesting developments:

Precoat filters remove smaller microbial particles (eg, bacteria and viruses) less effectively than they do parasites, unless the coating materials are chemically pretreated; for example, with aluminium or iron coagulants, or with cationic polymers. In a pilot study by Schuler and Ghosh (1990), removal of coliforms with untreated DE was about 0.36 logs, increasing to 0.82 logs with a coating of alum at 1 mg/g DE, and to 2 logs at 3 mg/g DE. This increase was probably due to the trapping of bacteria by the alum. A similar beneficial effect was observed using cationic polymers; at 3.5 mg/g DE, removal of coliforms increased to 3.3 logs. The authors concluded that this increase in removal could be due to an increased site density on the polymer-coated DE for adsorption of negatively charged coliform cells. A similar improvement in removal of bacteria was reported for the pilot study conducted by Lang et al (1986). Alum coating of DE increased removal of total coliforms from 0.16 logs to 1.40 logs, and of HPC bacteria from 0.36 logs to 2.30 logs. Removal of viruses also increased with chemical pretreatment of filter cake (Brown, Malina and Moore 1974). The removal of bacteriophage T2 and poliovirus was about 90 percent (1 log) for an uncoated filter, but increased to more than 98 percent (1.7 logs) when the filter cake was coated with ferric hydrate or polyelectrolytes.

## 14.2.1 Vacuum or standard DE filtration

The DE is introduced into the water stream by a dosing pump drawing from a stirred DE slurry tank. The concept is to capture the DE particles on a membrane and use them to build up a filter wall. The membrane, a heavy linen type of material, surrounds a solid base called a septum. This usually consists of ABS or PVC tubes with 2–3 mm holes in the walls that allow the filtered water to enter, where it is collected and passed to the next stage.

To create a DE coat on the membrane, a high initial dose is applied, which quickly (say in 20 minutes) builds up a layer of perhaps 2–3 mm thick. This stage is known as the precoat stage and the water during this stage needs to be recirculated until full filtration is established. The amount of precoat applied depends on the filtering surface area. The precoat is measured in kg/m<sup>2</sup>; the normal precoat dose is about 1 kg/m<sup>2</sup>.

During the filter run (ie, the time the filter operates before the DE must be washed off and the septum recoated), a small maintenance dose of DE is added to the incoming water. This is called the body feed. Its dose rate is based on the turbidity of the raw water and filtration rate, and must be determined by experience. As a guide, fairly clean raw water can be dosed at about 0.15 kg/m<sup>2</sup>/day. This needs to be increased as the turbidity increases. The filtered water should (in theory) contain no particles larger than

about 2–3 microns (micrometres). DE therefore provides an effective barrier against the (oo)cysts of *Giardia* and *Cryptosporidium*.

The optimum filtration rate is about 0.8 L/s/m<sup>2</sup> (2.9 m/h) with a maximum of 1.2 L/s/m<sup>2</sup> (4.3 m/h).

## 14.2.2 Pressure or modified DE filtration

Many newer DE plants are contained inside a pressure vessel. The concept is similar to that of vacuum DE systems but varies in that:

- the precoat can be applied as quickly as five minutes; again to a thickness of 2–3 mm
- there may be no body feed, although if there is any suspicion of cracking or shrinkage of the cake, body feed should be used
- the filter run time is usually shorter than vacuum filtration due to the higher filtration rate. The optimum filtration rate is about 1.25 L/s/m<sup>2</sup> (4.5 m/h) with a maximum of 1.6 L/s/m<sup>2</sup> (5.8 m/h)
- there may be provision for a drop coat procedure, where the DE coat is backwashed off and then re-applied, without removing it from the vessel. This technique increases the risk of recycling previously trapped protozoa, thereby lowering drinking-water quality. Another reason for not using the drop coat technique is because fine clays etc become embedded in the filter support or element cloth, shortening filter runs, and requiring more frequent overhauls. Overhauls involve taking the top off the filter, removing the elements, waterblasting them, and reassembling the unit.

**Figure 14.1: Diatomaceous earth pressure plant at Mokau, Waitomo District**



Courtesy of Filtration & Commercial Pumping Ltd.

## 14.2.3 Some operating issues with DE filtration

- **Establishing the pre-coat:** During this time filtered water must be recycled.
- **Body feed:** The idea behind a continuous body feed is to supply loose DE to plaster over any cracks that develop in the pre-coat. These cracks are possible, given the flexible substrate of the membrane. The continuous feed also ensures that the porosity is maintained.
- **Filter run time:** Limitations on the filter run time are usually caused by accumulated headloss. With clean feed water (say, under 2 NTU), headloss will build up at between 0.06 and 6 m/day. For example, where the maximum headloss allowed is 4 metres, the filter run time may be between one day and several weeks.
- **DE handling and disposal:** DE is a siliceous material and can cause respiratory problems if inhaled in dry form. Care must be taken with handling procedures, including removal and disposal (normally to landfill) of spent material.

## 14.2.4 Monitoring

The DWSNZ use turbidity as an operational requirement in place of monitoring for protozoa against the MAV and the monitoring requirements are described in the DWSNZ. Should the turbidity exceed these requirements the operator should check whether:

- the DE dose is appropriate for the raw water conditions
- the cake has built up enough before drinking-water is produced
- the treatment rate through each filter is within specification
- the filter cake has shrunk or cracked, ie, whether the body feed is appropriate
- there is any short-circuiting
- the raw water quality has changed.

It is recommended that water suppliers establish a control limit for each MAV or operational requirement. Control limits are discussed in Chapter 17: Monitoring. The preventive actions that are to be considered when a control limit is reached are to be documented in the WSP. The purpose of control limits and the preventive actions is to avoid reaching any transgression levels or operational requirements. For example, a control limit for turbidity of the water leaving each filter set at about 0.25 NTU may be advisable.

## 14.3 Slow sand filtration

The World Health Organization published *Slow Sand Filtration* in 1974. It is still in demand and much of its content remains valid so they continue to make it available electronically. WHO (1974) states that under suitable circumstances, slow sand filtration may be not only the cheapest and simplest but also the most efficient method of water treatment. The process requires a lot of land.

Slow sand filtration began in the early 1800s and was developed at regular intervals throughout that century. Its history, purification mechanisms, design, operation and maintenance requirements and other details are described extensively in a report *Slow Sand Filtration*, published in 1991 (in a period when renewed interest was being taken in the process) by the American Society of Civil Engineers, and in WHO (1974). Also refer to WHO (2004a).

Slow sand filters are not widely used in New Zealand. Examples have included Little River in Banks Peninsula District and Linton Army Camp near Palmerston North. The process produces drinking-water in Apia (Samoa). The Paris water supply (from the River Seine) is treated by slow sand filtration (and other processes) at the Ivry sur Seine plant. It is used there as an organic barrier, particularly to phenols and similar contaminants.

Slow sand filtration (sometimes called biological filtration) operates by two methods:

- a surface filter, which processes the water biologically
- a deep sand bed, which purifies the water by adsorption and some straining.

Slow sand filters comprise a relatively deep sand bed supported on a layer of graded gravel over underdrains (the sand typically 0.9–1.2 m deep on start-up and not to reduce below 0.6 m before resanding). The sand is finer than the 0.6–2 mm range that is typical in the more common rapid granular media filters, having, typically, a mean particle size in the range of 0.15–0.4 mm. This is similar in size to most beach sand. The water takes several hours to pass through the sand, providing ample time for purification by adsorption of microscopic particles adhering to sand grains; 1 m<sup>3</sup> of sand has a surface area of about 15,000 m<sup>2</sup>!

The filters should operate with a head of 1–1.5 m of unfiltered water above the sand. It is most undesirable that the water level in the filter box should drop below the surface of the filter medium during operation. To eliminate the possibility of this happening, a weir is incorporated in the outlet pipe system. The water sits above the sand for 3–12 hours.

The surface of the sand ripens; that is, a biologically active layer, primarily of algae and bacteria, develops on it, adding a biological process to the sand filtering. Ammonia and nitrite can be oxidised in this layer and the organisms living there strip nutrients from the water too. This surface layer is called *schmutzdecke*, a German term meaning dirt layer or filter skin. It takes a day or so to develop and, until it does, the filter will not present a proper barrier to microbial pathogens. This layer does not develop on rapid granular media filters because they are backwashed before any significant amount *schmutzdecke* has had time to develop.

The loading rate (the flow per square metre of filter bed surface area) is low, usually at a constant flow of 100–300 litres per second per square metre per hour, which equates to an equivalent velocity of 0.1–0.3 m/h. The rate may also be expressed as mm/s or m/d. A rate of 0.1 mm/s is equivalent to 0.36 m/h. For protozoal compliance, the DWSNZ state that the filtration rate should not exceed 0.35 m/h, and must be constant. Note that rapid granular media filters (after coagulation) can operate successfully at 30–40 times this rate.

Even at this slow rate, the headloss is typically around 0.1 m when the sand is clean, and increases to about 1.2 m when the sand needs cleaning. This initial headloss is due to the fine size of the sand and the depth of the bed.

There is no backwash system, so all solids captured build up on the surface, with a small amount of penetration into the sand. For protozoal compliance (earning 2.5 log credits), the final water turbidity should be below 0.5 NTU (section 5.10, DWSNZ), and some form of post-disinfection will almost certainly be required in order to achieve bacterial compliance (section 4.3, DWSNZ).

Section 3.6 of WHO (2009) discusses a modification of slow sand filters for household use, calling them biosand filters. These can be used intermittently.

### 14.3.1 Cleaning

When the bed resistance (headloss) has increased to such an extent that the regulating valve is fully open, it is time to clean the filter bed, since any further increase is bound to reduce the filter output. The top 20–30 mm of sand is scraped off and discarded. Sand removal at small plants can be manual but at larger plants it is more common to use a mechanised system to avoid the large amount of labour required. The water is then turned back on and the filter left to ripen so the *schmutzdecke* layer can build up enough to provide effective filtration again. If the scraping has been completed before the bed has dried out, ripening should take only 1–3 days. During ripening, the water is recycled, passed to another filter, or passed to waste during this time.

Ultimately, maybe after 20–30 scrapings, perhaps after several years, and before the sand reaches its minimum design depth, topping up with new sand, or full cleaning, or complete replacement, will be required. To accelerate the ripening process after resanding, some of the residual bottom sand or scrapings from the surface layer can be placed over the new sand.

A new filter must be run continuously for at least several weeks in tropical climates and longer where temperatures are low (WHO 1974). The time also depends on the nature of the raw water: the cleaner it is, the longer the ripening process will take. As ripening proceeds, there will be a slight increase in the headloss across the bed as the organisms build up, and the formation of a *schmutzdecke* will gradually become visible. These are signs that ripening is proceeding satisfactorily, but only after comparative chemical and bacteriological analyses of raw water and effluent have demonstrated that the filter is in full working condition may the effluent be directed to the public supply.

A detailed study in the Netherlands found removal of MS2 bacteriophage and *E. coli* WR1 was strongly dependent on the water temperature and *schmutzdecke* age; Schijven et al (2013). This model is intended to be incorporated into the Dutch 'legislatively required quantitative microbial risk assessment' (QRMA) and reduce the monitoring required for determining removal efficiency of SSF.



Because of the need to ripen cleaned filters, treatment plants need more than one filter, preferably at least four. The weakest point of a sand filter is the edge where raw water may leak past; to minimise this filters should be at least 100 m<sup>2</sup>, preferably double this.

Full records of cleaning operations should be retained.

## 14.3.2 Monitoring

The primary protozoal compliance monitoring criterion for slow sand filtration is the turbidity of the filtered water. This should remain under 0.5 NTU (section 5.10, DWSNZ). Should it exceed this, the operator should check whether:

- the sand bed has been disturbed; in particular, whether the sand has bound together then cracked, or pulled away from the filter walls
- the *schmutzdecke* layer still appears normal. If it has been poisoned or damaged in some other way, it may have died off and be losing material into the sand
- the raw water quality has changed abruptly; in particular, whether significant turbidity from clay (rather than coarser material) has been present. An increase in turbidity could be due to heavy rain in the catchment
- any operating parameters such as temperature, pH, flow through each bed, headloss, downstream chlorine demand etc has changed significantly. The operator should assess whether this was good or bad news and how it relates to the higher filtrate turbidity. Colder water, for example, should show higher headloss but not necessarily higher turbidity.

If the turbidity of the filtrate from any filter exceeds 0.5 NTU for more than 5 percent of the time, the cause needs to be determined and resolved before the water from that filter can be used. If it is not possible to shut off the supply from the filter during the investigation, boil water notices must be issued. If the filtered water turbidity is greater than the raw water turbidity, there is a real chance that the filter is discharging; if it is not due to a sudden change in raw water quality, shut down the filter, scrape off the top sand and ripen again.

It is recommended that water suppliers establish a control limit for each MAV or operational requirement. Control limits are discussed in Chapter 17: Monitoring. The preventive actions that are to be considered when a control limit is reached are to be documented in the WSP. The purpose of control limits and the preventive actions is to avoid transgressions of the MAV or operational requirement. For example, a control limit for turbidity of the water leaving each filter set at 0.30–0.40 NTU may be prudent.

WHO (1974) considers the following are the basic records that should be kept for each filter:

- the date of commencement of each cleaning
- the date and hour of return to full service after ripening
- daily raw and filtered water levels, and headloss
- the filtration rate

- raw water and filter effluent quality, ie, colour, turbidity, temperature, *E. coli*
- details of incidents, unusual weather etc.

### 14.3.3 Aeration

The filtered water may become anoxic as it passes through the sand so may need to be aerated to restore the dissolved oxygen level and remove dissolved carbon dioxide. This is achieved by having a simple weir on the outlet, dropping the filtered water about 1 m vertically. The water passes first through the sand, then through the underdrains and is taken back up to the top of the weir, which is on the same level as the sand surface. This arrangement ensures the water level in the sand does not drop below the surface. If this happens, the surface will dry out, killing the biota, and air will blind off some of the flow paths through the bed. The weir also ensures that the filter operates independently of any level fluctuations in the water above the sand.

### 14.3.4 Some operating issues with slow sand filtration

- **Raw water quality:** The water going on to the filter should not be too turbid or the filter will quickly overload. Experience will show when this level approaches. Although raw waters up to 100 NTU have been treated successfully for brief periods, 50 NTU is a more realistic upper limit, and optimum purification occurs around 10 NTU. Very turbid raw waters should receive some form of pretreatment.
- **Controlling algal growth:** The amount of algal growth on the surface must be limited, but not prevented. Algae require sunlight so the simplest method of controlling their growth is to limit sunlight where necessary. The Little River units (two in parallel) do not have this feature and have not had this problem.
- **Cold weather:** This can reduce the filter's effectiveness in two ways. As well as limiting the biological activity in the *schmutzdecke* layer, low temperatures also increase the headloss by increasing the viscosity of the water. Slow sand filters are recognised as being more suited to, and more efficient in, warm climates. The DWSNZ call for a minimum temperature of 6°C for protozoal (oo)cyst control. If this temperature is likely to be reached, water suppliers may consider covering the filtration area to limit the cooling effect of wind and frost.
- **Disinfectants:** Chlorine, or any other disinfectant or algicide, should not be added before the water is filtered, because it will kill the organisms in the *schmutzdecke* layer. Efficiently operated slow sand filters have been demonstrated to be effective in removing protozoal (oo)cysts, as well as bacterial and viral pathogens. However, dosing chlorine after filtration is strongly recommended.

# 14.4 Membrane filtration

## 14.4.1 Introduction

This section aims to provide the reader with a general understanding of the issues related to membrane filtration for drinking-water treatment in New Zealand, and covers:

- the history and current status of the technology
- the fundamentals of microfiltration (MF) and ultrafiltration (UF) for drinking-water applications. Nanofiltration and reverse osmosis (NF and RO) are discussed briefly
- the fundamentals of membrane filtration operations for drinking-water quality management.

The application of membrane filtration for drinking-water applications has increased markedly in recent years, with a membrane option considered for most water treatment applications. The increase in uptake has been driven by a number of factors, from lowering unit capital and operating costs, to the emergence of low-pressure membrane technology (reducing power demands), and a greater emphasis on correct pretreatment selection. In addition, advantages offered by advanced materials and low footprint designs have given membrane options additional weight when compared with more traditional treatment approaches.

Membrane technology is still developing. The cost of treating water through reverse osmosis membranes is approximately one tenth of the cost it was in 1978. Similarly, the energy requirement is approximately one quarter of that used in 1980 to treat the same volume of water through reverse osmosis membranes. As a result in these dramatic reductions in the cost and energy required, the adoption of reverse osmosis globally as a water treatment process has accelerated exponentially over the last few decades.

These recent developments have been aided by the emergence of further, legitimate evidence supporting membrane filtration as a secure means to eliminate pathogenic organisms from the water supply, in particular, the protozoal species *Cryptosporidium* and *Giardia*.

For the *Drinking-water Standards for New Zealand 2005, revised 2008* (DWSNZ), membrane systems may attain log credits in accordance with the system validation. So far most MF plants in New Zealand have been assigned 4 protozoal log credits, however, in special circumstances, this may be as high as 5, or possibly even higher.

## 14.4.2 Current experience in New Zealand and overseas

As at April 2005 five membrane plants exist in New Zealand for drinking-water treatment. These vary in type and capacity. All are of the UF or MF genre and have been designed and installed since 1999. A number of upgrades and projects are ongoing that may include membrane technology. At present two principal suppliers cover the market in New Zealand; additional suppliers will enter the market in the future.

Overseas, the number of plants adopting membrane technology is increasing, particularly in US, Europe and Asia. In the UK, for example, membranes have been adopted at various water treatment plants to meet the *Cryptosporidium* Regulations (1999). The largest membrane plant in Europe was commissioned in 2001, the Clay Lane WTP (160 ML/d). In 2003, Invercarnie WTP (80 ML/d) in Scotland was commissioned to meet Scottish Executive *Cryptosporidium* Regulations.

An interesting application of membrane filtration at the Méry-sur-Oise water treatment plant in Paris was described by Cotte et al (2005). They replaced coagulation, filtration, ozonation, biological granular activated carbon filtration with clarification, ozonation, biological dual media filtration, cartridge filtration, nanofiltration and UV disinfection. Dissolved organic carbon in the distribution system fell from about 1.8 mg/L to 0.75 mg/L, and biodegradable dissolved organic carbon fell from about 0.6 mg/L to 0.1 mg/L. This enabled the chlorine dose to be cut back, which combined with the lower organic matter, reduced the trihalomethane content from about 0.2 mg/L to 0.008 mg/L; bacterial numbers were significantly lower too.

## 14.4.3 Fundamentals of membrane filtration

There are four principal classes of membrane filtration that apply to drinking-water treatment:

- microfiltration (MF)
- ultrafiltration (UF)
- nanofiltration (NF)
- reverse osmosis (RO).

Of these, MF and UF are most commonly specified for drinking-water applications, with the five existing plants in New Zealand comprising these technologies. RO has been used in industry and household supplies.

## Microfiltration and ultrafiltration

MF and UF are characterised by their ability to remove suspended or colloidal particles via a sieving mechanism based on the size of the membrane pores in the membrane, relative to that of the particulate matter. Pretreatment (mainly coagulation, with or without sedimentation) is needed to remove colour and very fine particles. MF and UF are often collectively called low pressure membrane processes. They operate in the 3–50 psi range, or -3–12 psi if using a vacuum system.

Each membrane has a distribution of pores, which will vary according to the membrane material and manufacturing process. There are two ways to represent pore size:

- nominal, the average pore size
- absolute, the maximum pore size.

MF membranes are generally considered to have a pore range of 0.1–0.2  $\mu\text{m}$  (nominally 0.1  $\mu\text{m}$ ), although there are exceptions, with some MF membranes marketed with pore sizes up to 10  $\mu\text{m}$ . Without pretreatment, MF membranes will remove most protozoa, many bacteria, but very few viruses.

For UF, pore sizes generally range from 0.01–0.05  $\mu\text{m}$  (nominally 0.01  $\mu\text{m}$ ) or less. With UF, classification in terms of pore size becomes inappropriate, due to the other mechanisms/ phenomena that take place at the membrane surface. In terms of pore size, the lower cut off for a UF membrane is approximately 0.005  $\mu\text{m}$ . Without pretreatment, UF membranes will remove probably all protozoa, most bacteria, and many viruses (consistently greater than 3 log removals).

Some UF membranes are categorised in terms of their molecular weight cut-off (MWCO) rather than a particular pore size. The concept of MWCO, expressed in Daltons (a unit of mass) is a measure of the removal characteristic of a membrane in terms of atomic weight (or mass) rather than size. Therefore, UF membranes with a specified MWCO are presumed to act as a barrier to compounds or molecules with a molecular weight exceeding the MWCO.

Typical MWCO levels for UF membranes range from 10,000 to 500,000 Daltons, with most UF membranes for drinking-water treatment at around 100,000 MWCO. Note that these are large molecules. UF membranes for drinking-water treatment are also characterised according to pore size with respect to microbial and particulate removal capability.

A key distinction when considering MF or UF technology for a particular application is whether to select a pressure or submerged configuration. The use of hollow-fibre membranes is normally selected, and this brief explanation assumes the use of this type of membrane. Hollow-fibres are bundled longitudinally and either encased in a pressure vessel or submerged in a basin, or cell.

Modules are contained in housings, or pressure vessels. Operating pressures for such systems vary from 20–280 kPa. Most applications require designated feed pumps to generate the required operating pressure, although some may be operated under gravity if sufficient head can be developed.

Most systems are referred to as dead-end in as much as all contamination material is trapped on the membrane surface. This is as opposed to generating a continuous reject stream.

While all hollow-fibre systems require pressure as the fundamental driving force, a submerged (or vacuum) driven system is distinguished by its use of negative pressure and is significantly different in terms of design and configuration. Unlike pressure systems, where each membrane module incorporates a pressure vessel, submerged systems use hollow-fibre modules that are driven under vacuum, immersed in an open tank or cell. While the ends are fixed, the lengths of the hollow-fibres are exposed to the feed water in the cell and move freely.

Due to the feed water being contained in an open tank, the outside of the fibres cannot be pressurised above the static head in the cell. Therefore a vacuum, approximately -20 to -90 kPa, is induced at the inside of the fibre walls, where it is filtered outside-in to the lumen (the centre or bore of a hollow-fibre membrane). By design, submerged systems cannot be operated via gravity alone (a common misconception), or in an inside-out mode of filtration. In some circumstances they may be operated by siphon.

Figure 14.2 shows a typical schematic of a submerged membrane system. In this arrangement the vacuum is supplied from the filtrate pump.

**Figure 14.2: Typical submerged membrane system**

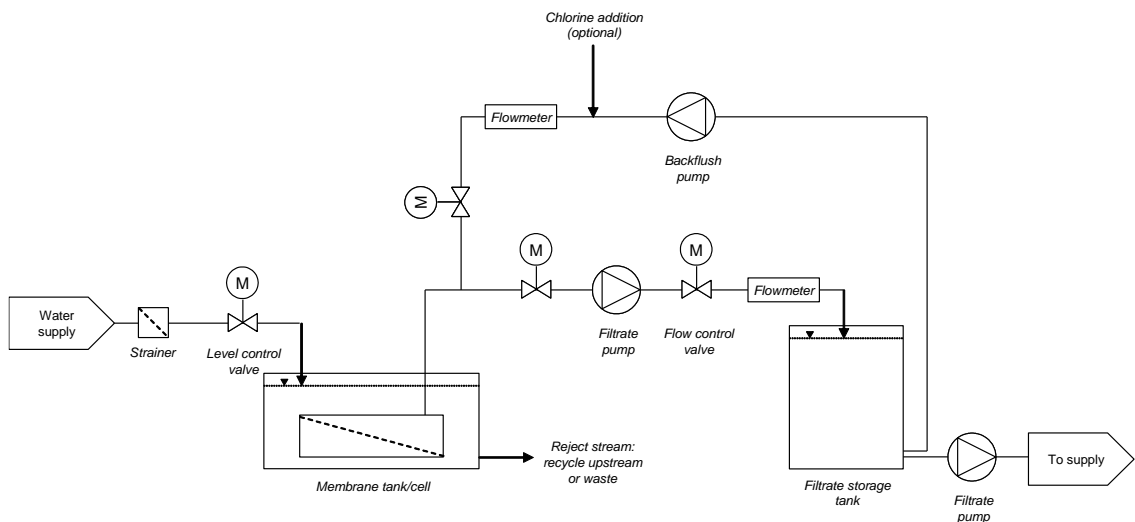

## Nanofiltration and reverse osmosis

NF and RO comprise a class of membrane processes that provide a higher degree of removal of contaminants compared with MF/UF. For example, NF systems can remove particles as small as 0.001 to 0.002  $\mu\text{m}$  (microns). Although NF and RO can remove nearly all bacteria and viruses, they are specified less frequently in drinking-water applications, mainly due to the much greater pressure requirements, eg, 800–1,000 psi (say 5,500 to 6,900 kPa or  $\text{kN/m}^2$ ), or even higher for RO where up to 10,000 kPa can be needed in desalination plants.

Removal of viruses by RO membranes may vary significantly and is a function of the membrane itself as well as its condition and the integrity of the entire system, including seals. Removals ranging from 2.7 to more than 6.8 logs, depending on the type of RO membrane, have been reported at bench scale using MS2 bacteriophage as the model virus, and the selection of membranes is an important factor in determining virus removal. Although RO constitutes an excellent barrier to micro-organisms, the maintenance of that barrier depends on the integrity of the system. Breaches of integrity in the membranes or the O-rings could lead to the passage of pathogens into the process water and must be monitored by integrity testing. Effective methods to measure the integrity of RO membranes should be used to achieve target removals. Currently, conductivity measurements are used, but the sensitivity limits their application to about 2 logs of removal. As bacteria have been shown to traverse through membrane defects, membranes cannot be considered as completely effective for disinfection and are commonly succeeded by a disinfection step (WHO 2011a).

Nanofiltration is a high-pressure membrane process that has been used traditionally as a softening process to remove hardness ions. Generally, NF membranes reject divalent ions (eg,  $Mg^{2+}$ ,  $Ca^{2+}$ ), but pass monovalent ions (eg,  $Na^+$ ,  $Cl^-$ ). Recently, NF has been used more extensively for removal of DBP precursors and colour. Although NF processes remove nearly all turbidity in feed water, they cannot be used for turbidity removal in the same manner as MF and UF due to the smaller pore sizes. Smaller pore size makes NF membranes more prone to fouling. The application of NF for surface waters is generally not accomplished without extensive pretreatment for particle removal.

NF/RO remove some dissolved contaminants, as represented by measurements of total dissolved solids (TDS) or conductivity ( $\mu S/cm$ , or  $mS/m$ ). The typical range of MWCO is less than 100 Daltons for RO membranes, and between 200 and 1,000 for NF membranes. RO is used sometimes for removal of chemical determinands not removed by existing processes. For example, it can be used to remove arsenic. Some point-of-use (POU) units use NF or RO. However RO also removes minerals and according to the WHO, there are very large numbers of people who consume levels of calcium and magnesium that are insufficient to support their physiological needs. Drinking water can contribute considerably to calcium and magnesium intake, depending on the geographical area, and therefore to the overall nutrition. Mineral removal by RO filtration could counteract potential health benefits of DBP removal.

As the majority of drinking-water applications involve MF/UF, these NF and RO technologies are not elaborated upon in the remainder of this section.

## 14.4.4 Membrane selection

The task of selection of the appropriate membrane will involve consideration of:

- design targets, final water quality, guarantees
- commercial, capital (CAPEX), operating (OPEX) and whole-life costs (WLC)
- site-specific conditions, any process limiting criteria.

One of the major issues to resolve in drinking-water applications is whether to use MF or UF. An outline of their characteristics was given earlier in section 14.4.

A key issue is virus rejection. Although the current DWSNZ do not impose a requirement for viruses, should the water supplier wish to have a higher level of security against virus infiltration using membrane technology, UF should be considered. Future editions of the DWSNZ are likely to address viruses. However, it should be emphasised that not all UF membranes are capable of virus rejection. Studies undertaken in the US in the mid 1990s demonstrated that membranes with a MWCO of 500,000 Daltons were less efficient at virus removal than another with a MWCO of 100,000. The designer should refer to the UF membrane manufacturer for data on their specific virus sized challenge data. It is not advisable to rely on membranes alone to provide primary virus protection; post-chlorination is recommended.

The decision to go with MF or UF technology can be marginal in some cases. In essence a higher degree of separation is returned by UF yet these can be counterweighted with risks. For all applications a risk assessment and cost/benefit analysis should be developed as an aid to the selection process.

## Membrane materials

Material properties directly impact performance. The main properties are shown in Table 14.1. Features such as porosity, pore size and shape, are surface roughness are important. Membrane materials can be manufactured in different geometrical configurations, which are then incorporated into a membrane module. Commercially available configurations include hollow fibre, spiral wound, tubular and plate-and-frame. Hollow fibre membranes are the most common form used in community water supplies. The most common membrane materials encountered in drinking-water treatment are:

- polypropylene (PP)
- polyvinylidene fluoride (PVDF)
- polyethersulphone (PES).

Polysulfone and cellulose acetate have been used too.

**Table 14.1: Properties of typical membrane materials**

|                               | Unit | Polyethersulphone (PES) | Polyvinylidene fluoride (PVDF) | Polypropylene (PP) |
|-------------------------------|------|-------------------------|--------------------------------|--------------------|
| Hydrophobicity (water hating) | –    | Medium                  | Medium                         | High               |
| pH range                      | –    | 1 to 13                 | 2 to 10                        | 1 to 13            |
| Chlorine tolerance            | –    | Good                    | Excellent                      | None               |
| Temperature tolerance         | °C   | High                    | High                           | High               |



## 14.4.5 Membrane plant operations

The operation modes of a MF/UF system comprise:

- **service:** time which the system is online and generating filtrate
- **backwash:** time which the membrane requires washing to remove entrapped particles and solids. Wastewater is produced during this operation. Operation restores clean head, although not completely
- **clean in place (CIP):** time which the membrane system requires chemicals applied to eliminate foulants not removed by backwashing. For example, natural organic matter or micro-organisms or biofilms adsorbed on the membrane; excess cationic polyelectrolytes need to be controlled carefully too. CIP restores permeability and resistance, although not completely due to some irreversible fouling
- **offline or out of service:** time which backwashing or CIP is taking place, or membrane integrity testing/maintenance procedures are being carried out. Some membrane systems remain in place while back-pulsing.

### Service mode

During service the membranes are pressurised, either by positive pressure or vacuum, and generate filtrate. The normal mode of operation is to maintain the flux by increasing the pressure as the filter blocks. In the constant pressure mode, the filtrate output drops as the pores block. Typically the membrane system shall be monitored for the following during the service mode:

- filtrate turbidity or particle count\*
- filtrate flow measurement (for measuring plant recovery)<sup>1\*</sup>
- transmembrane pressure<sup>2</sup> (TMP)\*
- cell level (protects membranes)
- filtrate temperature (computed in TMP)
- filtrate pump speed/frequency (if VSD operated).

\* Key operating parameter.

Depending on the degree of automatic control, during this mode the membrane plant requires little operator attention other than observation of key operating parameters. Normally a PLC based control system is provided, with an operator interface to observe key operating variables.

The service period should be of the order 98–99 percent of the operating day, accounting for regular backwashing.

<sup>1</sup> The volumetric percent of feedwater that is converted to filtrate in the treatment process over the course of an uninterrupted operating cycle. This excludes losses attributable to backwashing and CIP.

<sup>2</sup> The difference in pressure from the feed to the filtrate across a membrane barrier.

Should the water quality deteriorate, for example in the case of a membrane plant fed from surface water during a flood event, or a significant decrease in temperature, this should be detected by the upstream instrumentation. This should then be communicated to the operations staff in the form of automatic alarms or flags to adjust the process conditions to maintain performance.

Submerged membrane systems are capable of handling high swings in solids loading or turbidity. The level and duration of such events will impact the permeability of the membrane. Membrane plants fed from surface waters may experience sudden changes in influent raw water quality, particularly in terms of colour, turbidity, organic material and metals. A change in pH may also be experienced depending on the nature of the catchment geology. Should the raw water quality be outside the design criteria of the system, the system may still cope as long as the appropriate operator actions are undertaken. These actions may comprise one or more of the following:

- visual checking of membrane outer surface/colouring. This is straightforward in submerged systems as membranes are exposed
- checking raw water quality and adjusting chemical conditioning if necessary to suit conditions
- checking upstream water quality instrumentation, ensuring still within calibration etc
- checking correct coagulant and/or coagulant aid dose rate. Dose rates should be established at commissioning/performance testing across the range in flows and qualities
- checking the coagulation pH is optimised
- checking hydraulic loading (flow) to membrane units, verification that flux is within design limits. The flux rate will reduce as fouling increases and the membrane manufacturer's minimum flux should be noted
- checking backwash and air scour flows and pressures are set correctly
- checking clean washwater quality/volume to ensure the correct quality and quantity of water is being used. Poor quality washwater should not be used.

Regularity of backwashing and/or CIP may increase temporarily to remove the additional contaminants from the membrane.

## Backwashing and clean-in-place (CIP)

During filtration mode, particles and materials that are too large to pass through the membrane pores stay in the raw water or stick to the surface of the membrane. The latter process is known as fouling. Fouling progresses as the membrane system progresses in the service mode and results in decreasing permeability. MF/UF membrane systems typically employ three separate cleaning strategies to alleviate membrane fouling, and these can be automated:

- air scour
- backwash (water)
- combined air scour and backwash
- clean-in-place (CIP).

In the context of a submerged system, air scour is employed continuously or intermittently in each tank. Blowers supply air back to the membrane tank. The bubbles physically agitate the membrane fibres and help to both displace debris that has collected on the membrane surface and to keep the water in the tank mixed.

On a regular basis (can be as frequently as every 15 minutes or even longer than 60 minutes), a backwash is conducted in which filtered water is pumped back through the membranes (inside out) to clean the membrane pores. This action is brief, normally lasting less than one minute. Membrane manufacturers may opt to use a low-concentration chemical solution, such as a dilute chlorine solution, in the backwash water to assist in the cleaning of the membrane pores. This may be favoured to arrest development of organic fouling. The backwash action can be provided by the permeate pumps on some multiple-unit systems through automatic valve switching.

Membranes require periodic chemical cleaning to remove fouling materials that are not displaced by backwashing. The term for the cleaning process is clean-in-place (CIP), since the membrane system(s) are shut down and the membranes are not removed from their locations. During CIP, the membranes are subject to intimate chemical contact through a series of operations. The operations may vary in their degree of automation depending on the nature of the system design. The different chemicals that may be used are proprietary agents, acids, alkalis, oxidants, chlorine and detergents, depending on the composition of the membrane fibres and the nature of the foulant. The membrane manufacturer's guidance should be followed.

The volume of chemical wastewater for CIP operations can be of the order 3 percent of the raw water flow rate during periods of high organic or metal salts loading on the membranes. The required frequency of this CIP will vary based on the raw water characteristics, operating flux<sup>3</sup> and the particular membrane material. A frequency of approximately once per month or longer should be attainable. The chemical cleaning solution in the tanks may be reusable if its strength does not deteriorate too significantly, but it is normally neutralised and discarded to waste.

An example of a CIP record sheet applicable to a MF system is presented in Table 14.4.

## Types of integrity testing

Integrity testing is required to ensure continuous and repeatable security that the membrane system is performing within its specifications. Integrity testing is also discussed in Chapter 8: Protozoa Compliance, sections 8.4.3.5, 8.6.2.3 and 8.6.2.4.

At present there are two classes of integrity testing:

- **direct integrity testing (DIT):** a physical test applied to a membrane unit in order to identify and/or isolate integrity breaches
- **continuous indirect integrity monitoring (CIIM):** monitoring some aspect of filtrate water quality (ie, turbidity, particle counts) that is indicative of the removal of particulate matter at a frequency of at least once every 15 minutes.

<sup>3</sup> The throughput of a pressure-driven membrane filtration system expressed as flow per unit of membrane area (eg, L/m<sup>2</sup>/h).

Currently there are two general types of DIT that are commercially available for use with membrane filtration plants:

- pressure-based tests (MF/UF)
- molecular marker-based tests (NF/RO).

The test used for a particular system depends upon the type of membrane filtration, target organism(s) and test sensitivity. The DWSNZ specify the compliance requirements within section 5.11 Membrane filtration – treatment compliance criteria, which should be referred to.

In addition to complying with the DWSNZ, the DIT method must be compatible with the particular membrane system. The membrane supplier should confirm whether the system is compliant or non-compliant.

Pressure (vacuum decay) tests are compatible with all the various types of membrane filtration that qualify under DWSNZ. The equipment required to conduct these tests is typically supplied with the proprietary membrane system. However, some types of DIT may not be available from a particular supplier. The test selection may also take account of site or system specific factors. For further details refer to the Membrane Filtration Guidance Manual (USEPA 2005) and the LT2ESWTR Final Rule (USEPA 2006). Membrane filtration is also discussed in Chapter 14 of the review draft LT2ESWTR Toolbox Guidance Manual (USEPA 2009).

## Control limits and transgression action guidance

The DWSNZ recommend upper control limits (UCL) set at, as a general rule, two-thirds of the appropriate compliance criterion, or MAV. For example, a membrane filtration system validated and certified to provide 4 log removal of protozoa requires an outlet (filtrate) turbidity of 0.10 NTU. Thus the control limit may be set at 0.07 NTU (and the outlet turbidity must always be less than the inlet turbidity). Turbidimeters must be specified to ensure resolution to this level. The water supplier may elect to specify upper and lower control limits (LCL) to give additional performance control and foresight of deteriorating performance.

Should the control limit be met for a period of 15 minutes, and assuming the backwash TMP trigger has not been met, it is recommended a backwash be initiated manually on the offending units. Should a CIIM instrument be located on each unit's filtrate, the offending unit should be backwashed. If a common instrument is used, each unit that the instrument monitors should be backwashed in a controlled sequence. Should the filtrate turbidity remain in excess of the control limit after the backwash, the unit must be taken out of service for direct integrity testing. This is preventive action as a transgression has not occurred (ie, not greater than 0.10 NTU). Note turbidity can exceed 0.10 NTU, but pass DIT.

## Setting the direct integrity test (DIT) test limit

The DIT is the principal means to assess membrane integrity where protozoal removal is the prime function of the membrane system. Test parameters and results can be linked to the particular treatment objectives to give a quantifiable and objective assessment of system performance.

Resolution, sensitivity and frequency needs for DIT are specified in the DWSNZ. For example, the resolution must be that a 3 µm particle (equivalent to the smallest *Cryptosporidium* oocyst) generates a test response. Thus, for pressure based DITs, the applied pressure must be great enough to overcome the capillary static forces that hold water in a breach of 3 µm in diameter in a fully wetted membrane thereby allowing air to escape (through a *Cryptosporidium* sized hole) and thus allowing the loss of air to be detected. A similar concept is applied to marker based tests.

Sensitivity is defined by the particular system performance validation and characteristics of the membrane system itself. The sensitivity must exceed that required to achieve the log credit. For example, 4 log credits must prove repeated 99.99 percent removal of protozoan species tested for. No generic limits can therefore be set.

The DIT limit must be defined and certified before the system enters service. As a minimum the DIT must quote the test threshold specified by the membrane manufacturer. The DIT must be carried out once every 24 hours of operating time.

## Interpreting continuous indirect integrity monitoring (CIIM) results

CIIM results are intended to provide an indication of system integrity between direct integrity test applications. The results are compared with the control limit that represents a potential integrity breach.

Caution should be noted as false negative and false positive results are possible with these methods. For example, false positive results may be created by the use of an air scour of the membrane surface as part of the backwash sequence and this may create artificially high results after the unit is returned to service. This may be overcome by running to waste until this known condition is resolved. In practice this may be a period of minutes per unit. Once the performance stabilises below the control limit, the unit is returned to feed forward service. This is more easily accommodated in multiple unit systems than systems with fewer units.

False negative results that arise may be more common than false positives when using CIIM. For example, turbidimeters are less sensitive than monitoring techniques used for direct integrity testing. This may be overcome by using more sensitive instrumentation, eg, laser turbidimetry, although this is more costly. The water supplier could increase the number of CIIM instruments. Each option should be evaluated for each application.

## Membrane repair/replacement

This applies to any component of the membrane unit that may allow an integrity breach should it fail, not just the membrane itself. The purpose of repairing the membrane is to prevent integrity breaches that may lead to performance transgressions.

The repair should take place whenever an integrity breach is detected, using DIT or CIIM methods. The source of the integrity breach, for example broken membrane fibre(s), should be located and repaired. The validation of the repair must be by a subsequent DIT, meeting the DIT limit for the system, to prove unit integrity has been restored before the membrane is returned to service.

As outlined previously, depending on the control limit set, integrity breaches leading to membrane repair/DIT may not necessarily represent a transgression. Proactive maintenance can therefore credit the system with maintaining compliance. The repair itself may take the form, for example, of pinning the fibre hole in each end of the membrane module. Thus two pins are inserted per fibre. Should a membrane module be subject to multiple repairs the operator may elect to replace the module itself, or insert a new module immediately to return the unit to service. Here, the repair may take place at the operator's leisure. This may be more cost-effective in terms of minimising plant outage.

The DWSNZ require direct integrity testing in accordance with section 5.11.1.

## General operations guidance

The operators should generate plant logs based on the plant operation and maintenance manuals (O&Ms). An example of a monitoring datasheet is presented in Table 14.3. In addition to data recorded online, for example by a SCADA system, this provides essential evidence of operations and plant performance and enables operators to become more knowledgeable of the features of the membrane plant.

The operator should review operational data regularly, such as the TMP, flow rates and the outlet turbidity. The operational staff should aim to detect any anomalies in the data and investigate them. This may lead to early detection of a problem. DIT data should be reviewed continually.

After a CIP, the operational staff should calculate the permeability, record the TMP immediately before and after in order to evaluate the magnitude of fouling that is removed, to determine how frequently cleaning is required and to estimate the long-term impact on membrane life. This information should be recorded in the operation log. Supplier consultation may be required should abnormal results be observed.

The outer colouring of the membrane fibres may be observed on submerged MF systems, however, little is visible on pressure systems. Should membrane change be required prematurely, the membrane supplier may offer biopsy services to help establish the nature of the failure. The end user should note the membrane supplier's warranty conditions as these are generally non-negotiable.

**Table 14.2: Typical design/operating criteria for MF/UF systems (guidance only)**

| Criteria   | Typical range for drinking-water application using MF/UF technology  |
|--|--|
| Flux rate – flow per unit of membrane filter area (recovery) | @ <2 NTU feed 50–90 L/m <sup>2</sup> /h (94–98%)<br>@ 2–10 NTU feed 40–60 L/m <sup>2</sup> /h (92–94%)<br>@ >10 NTU feed <50 L/m <sup>2</sup> /h (90% min) |
| Recovery   | 95–98%   |
| Flow control, maximum rate of change per minute              | 1.5–5%   |
| Backwash and chemical clean-in-place (CIP) intervals         | Backwash: 15–40 minutes<br>CIP: 30–40 days   |
| Membrane life  | >5 years   |

The calibration of any online instruments, for example turbidimeters, pH meters, should be performed on a weekly basis. If particle counters are used, calibrate in line with manufacturer’s recommendations.

Other operational checks should be conducted following the requirements of the validation, the DWSNZ and the manufacturer’s instructions.

## Membrane plant hydraulics

The membrane system should meet the hydraulic characteristics and constraints of the site and/or interfacing plant. This applies to both gravity (submerged) and pressure systems.

Where submerged systems are being designed, caution should be taken with respect to upstream buffering and lags at varied design flows. A hydraulic model should be constructed across the design envelope, for example, to size channels correctly and to determine if overflows are necessary.

Pressure systems are pumped and this design should default to the membrane supplier. Generally it is recommended that head is broken (filtrate side) from the membrane system, as opposed to feeding the next stage process directly. This avoids possible interference with the downstream process in terms of pressure variance or loss.

The operation sequencing of membrane systems should be considered carefully in terms of operation dynamics as this can be complex. The modes of operation, for example filtration, backwash, CIP, must be balanced to ensure operation risk is low. It is normal to provide standby membrane plant to securely meet the nominal design output. For example, for a submerged system, two standby cells may accompany an array of six operating cells.

**Table 14.3: Data log and check sheet**

| Unit model                                     | Site |
|--|------|
| <b>Backwash timer setting</b>                  |      |
| Date   |      |
| Time   |      |
| Hours run                                      |      |
| TMP <sup>(1)</sup> (kPa)                       |      |
| Temperature (°C)                               |      |
| pH   |      |
| Feed turbidity (NTU)                           |      |
| Filtrate turbidity (NTU)                       |      |
| Feed FFI (x 10 <sup>12</sup> m <sup>-2</sup> ) |      |
| Filtrate flow (L/h)                            |      |
| Feed flow totaliser (m <sup>3</sup> )          |      |
| Filtrate flow totaliser (m <sup>3</sup> )      |      |

1 TMP = feed pressure – filtrate pressure.

## Daily pressure decay test

Perform approximately five minutes after backwash.

| Filtrate pressure |           |
|-------------------|-----------|
| At 0 minutes      | _____ kPa |
| At 2 minutes      | _____ kPa |
| At 4 minutes      | _____ kPa |

**Table 14.4: Chemical cleaning log sheet – provided by membrane supplier**

| Chemical cleaning report |                       |
|--------------------------|-----------------------|
| Client                   | Location              |
| Membrane model           | Application           |
| Today's date             | Date of last cleaning |

| Parameters                | Before cleaning | After cleaning |
|---------------------------|-----------------|----------------|
| Flow rate                 |                 |                |
| Backwash interval         |                 |                |
| TMP                       |                 |                |
| Feed temperature          |                 |                |
| pH                        |                 |                |
| TMP rise between backwash |                 |                |

| Chemical | % conc | pH | Conductivity | Temperature |
|----------|--------|----|--------------|-------------|
|          |        |    |              |             |
|          |        |    |              |             |
|          |        |    |              |             |



| Cleaning scheme | Duration (minutes) |
|-----------------|--------------------|
| Recirculation   |                    |
| Aeration        |                    |
| Soak            |                    |

**Comments**

## 14.5 Cartridge filtration

The advantages of bag and cartridge filtration processes include low maintenance requirements, minimal operator skill and attention required, and low space requirements. The only routine maintenance required is filter replacement when a predefined terminal pressure drop or other operating parameter, such as filter age or volume treated, is reached. The operation of these systems is generally straightforward and requires little technical skill. In addition, the filter materials are relatively inexpensive and the housing system is not complex, resulting in relatively low capital costs.

An economic disadvantage of bag and cartridge filtration processes is that the filters must be replaced instead of being regenerated or washed. For larger flows, or water with higher particle loads, frequent filter replacement increases operation and maintenance costs. Additional pumps may be required to provide needed pressure.

A cartridge filtration plant consists of cylinders (or housings) packed with filter cartridges through which the water flows from the outside of the filter into a central collection duct. Cartridge filtration is used in other industries too, so care must be taken to ensure water supply filters are used, ie, the filtration units must comply with NSF/ANSI 53 Standard or similar standards.

A single filter unit or plant comprises the filter medium, its housing, and associated piping and valves. A housing may contain between 1–20 filters.

The particulate loading capacity of cartridge filters is low. Unless the raw water is very clean, these systems usually incorporate some form of pretreatment to remove the bulk of the particulate matter to extend the cartridge filter life. A rule-of-thumb guide is that the water entering the filter should have a turbidity of <3 NTU. If another cartridge filter is to be used upstream, it has been found that a 20–50 micron screening filter is quite effective, see sections 12.3.4 and 12.3.6 in Chapter 12: Treatment Processes, Pretreatment. A filter-to-waste component is recommended for any pretreatment pressure sand filters. At the beginning of each filter cycle and/or after every backwash of the prefilters a set amount of water should be discharged to waste before water flows into the bag/cartridge filter.

Some cartridge filters on the market are claimed to be able to be backwashed. This is not to be done because the washing process can progressively dislodge fibres from the medium, ultimately allowing more and more particles to pass through.

Cartridge types vary widely in size, cost and effectiveness. Testing has shown wide variations between different types. Unlike membrane filtration, there is currently no technique for direct integrity testing. For these reasons, the *Drinking-water Standards for New Zealand 2005, revised 2008* (DWSNZ) require a safety factor over their validated protozoa removal performance. For cartridges that are validated to achieve 3 log removal of *Cryptosporidium*, 2 log credits may be awarded. See Chapter 8: Protozoa Compliance, section 8.4.3.4 for information about validation or certification. Refer also to Chapter 8 of the review draft LT2ESWTR Toolbox Guidance Manual (USEPA 2009) which discusses issues related to cartridge filtration.

## Cartridge size

The standard size is 248 mm (9.75 inches) or 254 mm (10 inches) long and 64 mm (2.5 inches) in diameter. This size is used for most small applications. Some suppliers will provide dual housings that will fit two (or more) of these in parallel. Due to seating problems, it is not normally recommended to use cartridge filters in series. For example, instead of joining two cartridges together, it is better to purchase a double length unit, say 19.5 or 20 inches long.

There are larger sizes for applications producing higher volumes. The sizes vary according to the supplier; 150 mm (six inch) diameter is often the next step up. The length also increases in the larger cartridges: 20, 40 and 60 inch options are some common sizes on offer.

## Filtration size

Filters are rated on their ability to remove particles of a specific size from a fluid, but the problem is that a variety of very different test methods are applied to specify performance. Because cartridge filters are fixed barriers, their effectiveness is expressed by the size of the smallest holes. This is usually measured in microns or micrometres (1,000 microns being 1 mm). Pore size ratings refer to the size of a specific particle or organism retained by the filter to a specific degree of efficiency. A filter that is marked '10 micron' has some capability to capture particles as small as 10 microns. However, this is meaningless unless there is a description of the test methods and standards used to determine the filter rating. Cartridge filters are often classified by either a nominal or absolute rating.

- **Nominal rating:** is just that, it exists in name only. It is meant to represent the size (or more commonly mean size) of the particles which a filter will exclude, maybe with an efficiency as low as 60 percent! It does not guarantee to remove particles of the same size as the nominal pore rating. It is used only to give a comparison within the same manufacturer's range.

- **Absolute rating:** purports to provide some certainty (usually 100 percent or close to 100 percent) of removing particles of the size quoted. It is meant to represent the actual size of the pores of a filter. However, the material used in the testing may be different (for example, it may be more flexible) than the material being filtered. The test protocol needs to be checked before you can be sure of performance. Filters with an absolute rating are not usually ratified by an outside agency; the rating generally represents the manufacturer's own assessment.

The 'nominal' and 'absolute' ratings are irrelevant for cartridges used for protozoal removal. They vary so much that each filter must pass a challenge test, see Chapter 8: Protozoal Compliance, section 8.4.3.4 Cartridge filtration.

To remove protozoal (oo)cysts such as *Giardia* and *Cryptosporidium*, 3 microns absolute is required, testing to NZS4348 (1995) is required. This size will not remove clays or silts, so most dirty water will remain dirty. To reduce the turbidity due to silt, 0.5 microns absolute is normally needed. For clay turbidity, smaller sizes may be effective. In all cases, it will be necessary to try out different sizes to find the rating required for the material.

## Filter cartridge types

How the layers are arranged within the filter will affect how many solids can be held before the cartridge becomes too blocked to pass the flow. Wound or low cost pleated cartridges usually achieve at least 3 log removals in testing; it is usually the design of the physical construction of the housing or its assembly that causes the problems.

- **Pleated cartridges** have a single sheet of filter membrane folded to and fro in a zigzag fashion. These are common in air filters for car motors. A further refinement of these is folded pleats, where the folds overlap each other, as if they were too big to fit up and down only. Pharmaceutical grade cartridge filters are often pleated, usually with a cage around them to make them rigid, ie, less susceptible to damage. Low-cost pleated cartridges can be damaged easily without it being obvious to the user.
- **Depth cartridges** have material of a coarser weave on the outside and finer inside. This allows smaller particles to penetrate further into the filter, allowing more solids to be held before blockage occurs.
- **Wound cartridges** have a continuous thread wound around a core to provide flow paths between the windings. They look a little like oversized bobbins of cotton, and are usually made from polypropylene. The earliest designs used a string material which was decomposed by micro-organisms in the water! Wound cartridges are now less common because they are susceptible to discharging when operating in the stop/start mode.

## Filter material

Most cartridges now use polypropylene as the filter medium. Also used are glass fibre (bonded with a resin) and nylon. Various other compounds are also used, polyethersulphone is an example.

## Filter housings

The key quality control issue is fitting the cartridges properly into their housings. Most seat on to knife-edge moulded end plates. It is very important to ensure that these are fitted properly into the ends of the cartridge elements, because a leak across this interface will break the whole filtration barrier. Always inspect the filter housing seal and the cartridge seal when changing a cartridge. It is very important to ensure that the cartridge is installed the right way up.

A pressure relief valve should be incorporated into the filter housing, and an automatic air release valve shall be installed on top of the filter housing.

Fitting the cartridge into the housing is covered by the requirements in Chapter 8 of the review draft LT2ESWTR Toolbox Guidance Manual (USEPA 2009) which discusses issues related to cartridge filtration, or the cyst/oocyst reduction conditions of NSF/ANSI 53, or Chapter 4 of EPA/NSF ETV (2002, updated 2005), or a standard formally recognised by the Ministry of Health as being equivalent.

**Figure 14.3: Cutaway showing cartridge seal**



Picture courtesy of Filtec Ltd.

This picture shows typical cartridge seals: Note there are knife edge seals at both the top and bottom of the cartridge.

## Operating issues

- **Commissioning:** verifying the assembly of a certified cartridge filter when it has been installed should be performed by demonstrating that the operating parameters necessary to achieve the specified performance rating, which have been previously established by challenge testing, are being achieved on site. The procedure should be as specified by the supplier.

- **Start-up:** To allow the filtration process to settle down when starting up or restarting, it is strongly recommended to filter to waste for the first five minutes of the filter cycle. Record the initial headloss or pressure differential, and check that it lies within the manufacturer's specification. Note in a log book all relevant information that may help in training and trouble-shooting, especially the date that the new cartridge(s) is installed so that its length of service (preferably volume treated too) is recorded.
- **Pressure testing for leaks:** Correct installation of the cartridge needs to be demonstrated for each cartridge renewal. The most likely failure is a lack of proper seating, allowing flow to leak through the top or bottom seals. Another common cause for failure occurs when the cartridge bursts.

The way to demonstrate that the integrity of the unit has not been breached is to measure the pressure drop across it when operating at the maximum rate.

A major difficulty with this is the accuracy of the pressure gauge. Precise gauges are expensive, probably more expensive than the filter unit itself. A simple way to reduce costs is to arrange the pressure sample lines to feed back to the same gauge; this approach also allows the inaccuracy in the gauge to be cancelled out. See Figure 14.4.

The greater the number of cartridge filters in a housing, the more attention must be given to the pressure readings. One faulty cartridge could be passing (oo)cysts, but if it is one of several cartridges in the housing, its effect on the pressure drop may be slight.

The same gauge is used to measure both upstream and downstream pressures. After installation, the upstream pressure is measured by opening that valve and shutting the downstream valve. Then, with the flow unchanged, the downstream pressure is read. The pressure drop should not be greater than that advised by the cartridge supplier. If it is, there is probably a leak through one of the seals.

Record as much information on checking and general operation as possible in the log book.

**Figure 14.4: Suggested arrangement for reading pressure differential across a cartridge filter**

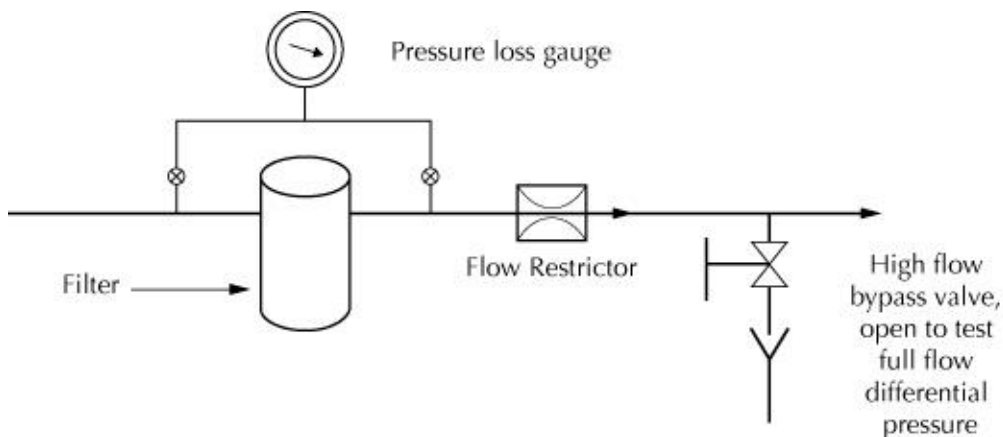

- **Pressure gauge recommendation**
  - Minimum size (4") 100 mm.
  - Accuracy 1 percent of readable scale, as per EN837.1 European standard.
  - Liquid-filled, this helps readability when vibrations are present.
  - Average cost \$150.
  - Maximum readability of 1 kPa cannot be met due to limitations on number of graduations that can be fitted into one 100 mm gauge.
- **Pressure testing for clogging:** If the clean cartridge pressure drop is recorded and the pressure drop is recorded during a filter run, the amount of clogging can be noted. The cartridge should be replaced when the pressure drop reaches or approaches the value advised by the cartridge supplier. Cartridge filters exhibit a knee shape curve of pressure drop over time; see Figure 14.5 (fictitious units). Cartridge filters do not load linearly; additional observation of the filter performance is required near the end of the filter run.

**Figure 14.5: Typical pressure drop across a cartridge during a filter run**

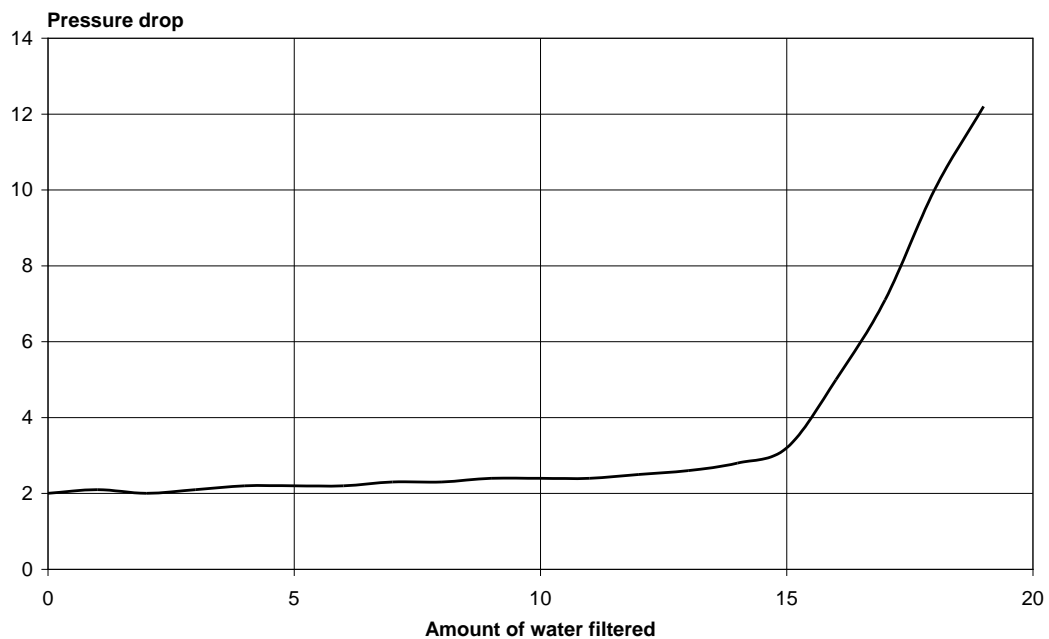

If a cartridge is not replaced at this point, the flow through it will be reduced. This may not be noticed at first if the flow is discharging into a tank or out through taps, because the change is not sudden or dramatic. Therefore, the pressure drop test should be repeated regularly, along with a simple flow test.

If the differential pressure is ever less than a previous reading, the cartridge must be assumed to have unloaded some of the trapped contaminants, and must be replaced, ie, the integrity of the filter has obviously failed.

- **Guarding against pressure changes:** Cartridges will release particles when bumped, by sudden pressure changes, or as a result of sudden changes in flow. For this reason, the valves connected to the filters should be of the slow opening/closing type such as screw-operated stopcocks, not bar-operated ball valves. Pumps cutting in and out will cause pressure surges so should not be connected directly to cartridges.

- **Flow control:** Cartridge filters must not be operated at flow rates above their stated design rate. If the installation is to meet the DWSNZ, flow control will be needed to limit flows above this. This may be an orifice or similar pressure-loss fitting, or the system may not be capable of excessive flows anyway. A simple flow test will demonstrate whether this is the case. Ideally, cartridge filters should be in continuous operation; restarting after a shutdown produces poorer quality filtrate for at least 30 minutes.

The filter plant should be designed to handle maximum day or maximum instantaneous flow. Prolonged operation at maximum flow clogs the filter faster than operating at lower flows. A minimum of two cartridge filter housings should be provided to ensure continuous water treatment in the event of failure in the filter operation and to allow for filter maintenance and replacement.

The flow through a cartridge filter should be as low as possible to lengthen filter run times and reduce surges. The filtrate should pass to a storage tank sized to cope with maximum demand, thus allowing the filter to operate at a near constant rate. On/off operation is not recommended; to avoid this, consider installing a recirculating pump that pumps treated water back to a point ahead of the cartridge filter. Care must be taken to make sure there is no cross-connection between the finished water and raw water.

- **Disinfection:** if the filter runs are very long, it will be advisable to check whether upstream chlorination is needed to prevent bacteria building up on, and subsequently sloughing off, the filter material and housing.

## Monitoring

The compliance monitoring parameters for cartridge filtration are differential pressure, flow and turbidity. The tests and their frequency depend on the population served; see section 5.12 of the DWSNZ and Chapter 8 of the Guidelines.

Very fine particles in the raw water will pass through the cartridge filtration system. If these predominate, the turbidity of the filtered water could be almost the same as the raw water. If the turbidity of the filtered water is greater than the raw or feed water for more than a few minutes, it must be assumed that the cartridge is discharging (unloading) some of its accumulated contaminants, and therefore the operating conditions must be corrected immediately, or the cartridge replaced.

Should any operational requirement be exceeded, the operator should check whether:

- the operating pressure across any one housing exceeded the manufacturer's limit, generally not more than 1.0 Bar (15 psi) difference between inlet to outlet, in which case the filtering medium may have ruptured
- a pressure differential reduction may be the result of damage to or bypass around the seal
- the raw water quality (or prefilter performance) has deteriorated
- there have been any flow surges or sudden pressure changes that may have dislodged particles
- the seals are no longer seated correctly: this could be indicated by the pressure differential no longer increasing.

If the plant experiences turbidity problems following cartridge replacement, consideration should be given to incorporating a flush-to-waste step, five minutes is usually chosen.

## 14.6 Bag filtration

Bag filters comprise a disposable bag fitted into a filtered water receiver vessel or housing. They can be pressure or open (gravity) versions. They are much like cartridge filters in operation, in that they present a single barrier filter. However, unlike most cartridges, the flow path is from the inside of the bag to the outside.

Bag filters are commonly used in industry to remove dust from air. Care must be taken to use filter bags manufactured for liquid applications only.

A single filter unit comprises the filter medium, housing, and associated piping and valves.

The particulate loading capacity of bag filters is low. Unless the raw water is very clean, these systems usually incorporate some form of pretreatment to remove the bulk of the particulate matter and extend the filter life. A rule-of-thumb guide is that the water entering the filter should have a turbidity of <3 NTU. However, even at the finest mesh size available, bag filters will not remove colloidal colour or dissolved chemicals.

Some bag filters on the market are claimed to be able to be backwashed. This is not to be done because the washing process progressively dislodges fibres from the medium, ultimately allowing more and more particles to pass through. Once the particulate loading capacity has been reached the bag filter is to be discarded.

Bags manufactured from needle felt, made from polyester, polypropylene or nylon, are suitable for pretreatment applications only. The nominal mesh size is from 1,000 microns to less than 1 micron nominal. See section 14.5 for comments on nominal and absolute ratings. Bag filters manufactured from melt blown polymers offer higher efficiencies and test results should be provided to support the supplier's claim of efficiency.

Bag filters may receive up to 1 log credit in the DWSNZ for protozoa removal. See Chapter 8: Protozoa Compliance, section 8.4.3.3 for information about certification requirements. The amount of log credit is less than has been achieved under test conditions because, as with cartridges, the chance of poor fitting and sealing is quite high. Also, as with cartridges, there is usually no continuous direct integrity test (although some have been installed with a turbidity monitor) so this potential loss of quality control has to be allowed for. Refer also to Chapter 8 of the review draft LT2ESWTR Toolbox Guidance Manual (USEPA 2009) which discusses issues related to bag filtration.

Bag filters are relatively common in industrial applications and have been used in some small water treatment plants, but are not common for larger towns. As at 2005 they are in use at Carterton, Pukekohe, and have been trialled at Okato (in Taranaki). The former sites are apparently operating reasonably well; the latter was not successful. Some trials fail due to a heavy load in the 3–10 micron range and low working head, resulting in reduced filter run times.



## Operating issues

Integrity and monitoring issues are the same as for cartridges (see section 14.5), and the following issues for cartridges apply also to bags.

- Filter cycling (starting and stopping of the pump or filter operation) can be problematic with bag filtration where the water is pumped directly from the source to the filter, and then out to the distribution system. In these situations, the filters operate on demand and the sudden increase in pressure across the filter causes premature wear and filter failure. Supplies using bag filters should consider the following recommendations for controlling the flow into the filter process to minimise filter cycling:
  - lengthen the filter runs by reducing the flow rate as much as possible through the filter
  - install or divert the flow to a storage facility (eg, pressure or storage tank) after the bag filtration process. The stored water can supply the frequent surges in demand and thus reduce the bag filter cycling
  - until a bag is replaced, the flow through it gradually reduces. This change is not sudden or dramatic; sudden changes indicate rupture or discharge of particles
  - the supplier sets the allowable pressure drop across the bag. If higher pressure drops are set up, the bag may rupture, creating a gap in the filtration barrier. Bag filters do not load linearly; additional observation of the filter performance is required near the end of the filter run
  - bags will release particles when bumped by sudden pressure changes due to sudden flow changes. Therefore, valves connected to the bags should be the slow opening/closing type. Pumps will cause pressure surges and should not be connected directly to bags. A pressure relief valve should be incorporated into the bag filter housing, and an automatic air release valve shall be installed on top of the filter housing
  - if the installation is to comply with the DWSNZ protozoa criteria, flow control is needed in order to limit high flows. This may be an orifice or similar pressure-loss fitting, or the system may not be capable of excessive flows anyway. Bag filters must not be operated at flow rates above their stated design rate. A simple flow test will demonstrate whether this is the case
  - to allow the filtration process to settle down when starting up, it is strongly recommended to filter to waste for the first five minutes of the filter cycle
  - ideally, bag filters should be in continuous operation; restarting after a shutdown produces poorer quality filtrate for at least 30 minutes.
- Very fine particles in the raw water will pass through the bag filter. If these predominate, the turbidity of the filtered water could be almost the same as the raw water. If the turbidity of the filtered water is greater than the raw or feed water for more than a few minutes, it must be assumed that the bag is discharging some of its accumulated contaminants, and therefore the operating conditions must be corrected immediately, or the bag replaced.

- The USEPA (2003d) found that different bags, even with the same stock and lot numbers, could exhibit a wide range of water treatment capacity. Some bags may treat many thousands of gallons of water while others may treat only a few hundred. Pore size gives only a general indication of a bag's capability. Common faults are related to rupture of the seams; gaps in heat welded bags; gasket integrity; and bypass, usually near the lid, typically shown by significant discolouration of the bag. Once a bag begins to foul at 5 to 10 psi differential, the time until the bag must be replaced quickly approaches; bag rupture is more likely near the end of the filter run.

## Monitoring

The compliance monitoring parameters for bag filtration are differential pressure, flow and turbidity, see section 14.5 for details. The tests and their frequency depend on the population served; see section 5.13 of the DWSNZ.

Should any operational requirement be exceeded, the operator should check whether:

- the operating pressure across any one housing exceeded the manufacturer's limit, in which case the filtering medium may be approaching rupture
- a pressure differential reduction may be the result of a rupture or bypass
- the raw water quality has deteriorated
- there have been any flow surges or sudden pressure changes that may have dislodged particles
- the seals are no longer seated correctly: this could be indicated by the pressure differential no longer increasing.

# 14.7 Adsorption processes

## 14.7.1 Activated alumina

Activated alumina based products have been used historically for the reduction of fluoride, arsenic and selenium. Point-of-use (POU) products using such media have been developed since the USEPA indicated acceptability of POU treatment as an alternative for small communities. Several types of media including unmodified activated alumina, manganese modified or iron modified alumina, and iron based granules are being investigated for use in a manner similar to granular activated carbon (GAC), packed into columns and inserted into housings. Some of these products are being tested for arsenic (V) reduction from 0.05 mg/L per the protocols recently incorporated into NSF/ANSI Standard 53 – Drinking water treatment units – Health effects.

A recent report (NSF 2005) describes the reduction of arsenic (V) from 0.025 mg/L to less than 0.002 mg/L using an activated alumina point-of-use treatment system. The unit shut down automatically after processing 800 gallons. The study found that the cost of POU treatment was less than the cost of operating a central treatment plant. The spent cartridges from the trial were tested for disposal safety according to the California Waste Extraction Test (WET) and EPA Toxicity Characteristics Leaching Procedure (TCLP) test. They passed both tests, indicating that disposal in the household refuse would be acceptable. Currently, there are 20 different products shown as certified for this capability on the NSF website.

While activated alumina primarily removes fluoride and As V (arsenate) and performs better at a lower pH (best between 5.6 and 6), iron-based media generally are more effective at removing both arsenic (III) (arsenite) and arsenic (V), although oxidation of arsenite to arsenate prior to filtration can increase its removal efficiency, depending on pH. In addition, activated alumina is more likely to experience interference affecting arsenic removal from competing ions such as silica, fluoride, phosphate, and sulphate than iron-based media. As with most column treatment systems, the granules can support the growth of micro-organisms. It has been reported that the bacteria can reduce arsenate to arsenite, thereby reducing the efficacy of the activated alumina.

Note that RO devices are certified under NSF/ANSI Standard 58 only for arsenate removal (USEPA 2006).

In New Zealand, geothermal or hydrothermal waters are the most likely to contain excessive fluoride levels; these waters usually contain high silica concentrations too. Arsenic V and silica are preferentially adsorbed by activated alumina media, so fluoride removal may not be very efficient. Fluoride removal is covered in USEPA (1984).

See Chapter 19: Small, Individual and Roof Water Supplies, section 19.3.4, for further discussion on point-of-use and point-of-entry treatment systems.

See USEPA (2003c) for a full discussion on arsenic removal technologies.

## 14.7.2 Solid block activated carbon (SBAC) filters

All types of carbon filters effect the removal of organic substances by adsorption on to the carbon surface. The filter in this device consists of extremely small particles of activated carbon that are fused together into a solid block with uniform pore size. If the carbon block configuration is constructed properly, the pore size may be uniformly 0.5 micrometre ( $\mu\text{m}$  or microns), which would be effective at removing asbestos fibres, protozoal (oo)cysts, and some bacteria. SBAC filters are less prone than GAC filters to channelling and can also be effective at removing organic contaminants such as some pesticides and chlorinated solvents. In addition, some SBAC devices are certified by NSF International for removal of methyl tert-butyl ether and selected disinfection by-products (DBPs) such as total trihalogenated methanes. They can also remove chlorine and can be formulated to remove metals such as mercury and lead.

With regard to limitations, SBAC filters typically will not remove most heavy metals, viruses, small bacteria, arsenic, fluoride, iron, or nitrate. These filters also tend to harbour bacteria that grow on trapped organic matter, and the bacteria can migrate from the filter to the water at a later time.

Most manufacturers recommend that the filters be replaced about every six months, even though the adsorptive capacity may not yet be totally exhausted. However, replacement may be required sooner depending on the quality of the incoming water and the amount of usage (USEPA 2006).

### 14.7.3 Granular activated carbon (GAC) filters

GAC is extremely porous and can have a surface area of about 1,000 square metres per gram. Many organic compounds, such as chlorinated and non-chlorinated solvents, naturally occurring organic matter, some gasoline components, and trihalomethanes, can be adsorbed on to the GAC surface. However, for some pesticides, such as atrazine and alachlor, GAC has a very low adsorptive ability.

This material is also effective for removal of chlorine and moderately effective for removal of some heavy metals and metals that are bound to organic molecules. Activated carbon processes show promise for removal of biotoxins and other potential organic contaminants of concern.

Regardless of the design, GAC filters are subject to clogging and, like all types of activated carbon filters, provide an environment for bacterial growth (see BAC below) which may present problems. Backwashing can improve long-term effectiveness for removal of organic compounds and provide some control of bacterial growth, but it does not improve radon removal efficiency. ANSI/AWWA (2012) has a Standard (B604-12) for GAC, and B605-13 covers its reactivation.

GAC is not effective at removing fluoride, chloride, nitrate, hardness, or most metal ions, and is not recommended at the point-of-use for removal of radon or VOCs. GAC is not as effective as SBAC, especially with regard to removal of chlorine, taste-causing substances, or halogenated organic compounds (USEPA 2006).

See Chapter 19: Small, Individual and Roof Water Supplies, section 19.3.4, and Chapter 18: Aesthetic Considerations, section 18.3 (under the heading of Taste and Odour), for further discussion on activated carbon treatment systems.

### 14.7.4 Biologically active filters (BAC)

These are normally granular active carbon filters (GAC) where the bacteria (and some other micro-organisms) are actually encouraged to develop on the granules. The carbon filter also removes some substances by adsorption. BAC filters develop layers of microbes, along with their associated exopolymers, on the surface of or within the granular medium matrix. This biologically active layer, called the *schmutzdecke* in conventional slow sand filters, retains microbes and often leads to their inactivation

and biodegradation. These microbes can also degrade natural organic matter and industrial organic chemicals. Ozone can be effective in partially oxidising organics in the water to biodegradable compounds that can be removed more readily by biological filtration. This increase in the biodegradable fraction of organic carbon occurs as a result of moderate to high levels of ozonation. These ozone levels are typical of the doses commonly applied for disinfection. But ozone may add undesirable compounds such as formaldehyde, NDMA and bromate.

WRF (2016) reported the results of an extensive study on the use of chemically enhanced biological filtration, defined as use of oxidants other than ozone, for increasing biological filtration effectiveness and decreasing disinfection by-product (DBP) formation potential. They trialled nutrient augmentation and a range of potassium permanganate dosages.

Upon start-up, an acclimation period ranging from weeks to months may be necessary for some contaminants. In general, biofiltration is more effective at temperatures greater than 15°C, dissolved oxygen levels greater than 3 mg/L, and within a pH range of 6-9. Increasing empty bed contact time (EBCT) beyond 10 minutes results in marginal improvement for contaminant removal by biofiltration, especially at temperatures greater than 15°C. However, at temperatures below 15°C, greater removal may be obtained with EBCTs longer than 10 minutes.

Adsorption processes are discussed in Chapters 9 and 13 of AWWA (1990). ANSI/AWWA B130-13 covers membrane bioreactor systems. Chapter 3 of USEPA (2004) is the Environmental Technology Verification (ETV) Technology Specific Test Plan for evaluation of drinking water treatment equipment utilising fixed bed adsorptive media for volatile organic chemical (VOC) removal.

## 14.8 Desalination

Desalination has been included in this section because at least some of the process can include membrane (reverse osmosis or RO) treatment. Distillation can also be used. Chapter 2 of WHO (2005) is titled *Desalination Guidelines Development for Drinking Water*. Chapter 12 is titled *Health Risks from Drinking Demineralised Water*. WHO (2011a) updates these and discusses related safety plans (WSPs).

WHO (2007) states that more than 12,000 desalination plants are in operation throughout the world producing about 40 million m<sup>3</sup> of water per day. The number is growing rapidly as the need for fresh water supplies grows more acute and technologies improve and unit costs are reduced. As at 2010, desalinated water provides about 20 percent of Israel's drinking water supply, and major expansions to cope with rising demand are predicted to increase this proportion to around 50 percent by 2020 (taken from WQRA (2011)).

Desalination plants use waters impaired with salts (seawater or brackish water) or other contaminants as their sources. About 50 percent of the capacity exists in the West Asia Gulf region. North America has about 17 percent, Asia apart from the Gulf about 10 percent and North Africa and Europe account for about 8 percent and 7 percent respectively, and Australia a bit over 1 percent.

The principal distillation systems include Multistage Flash (MSF) distillation, Multi-effect Distillation (MED) and Vapour Compression Distillation (VCD). Distillation plants can produce water in the range of 1 to 50 mg/L TDS. As a comparison, RO processes can produce water in the range of 10 to 500 mg/L TDS.

Common membranes are polymeric materials such as cellulose triacetate or more likely polyamides and polysulfones. Membranes are typically layered or thin film composites. The surface contact layer (rejection layer) is adhered to a porous support, which can be produced from the same material as the surface.

In electrodialysis-based treatment systems a direct current is passed through the water, which drives the ions (not the water) through membranes to electrodes of opposite charge. In electrodialysis reversal systems, the polarity of the electrodes is reversed periodically during the treatment process. Ion-transfer (perm-selective) anion and cation membranes separate the ions in the source water. Electrodialysis reversal systems do not provide any barrier against pathogens, and electrodialysis reversal is, therefore, rarely considered to serve as the main treatment barrier for drinking-water production.

Desalinated water is stabilised by adding lime and other chemicals, and/or by blending with other water, both to offer a balanced mineral content and to reduce corrosion effects.

Most of the inorganic components will be significantly removed in the desalination process, either thermal or RO, although some sodium chloride and bromide may be present in the treated water from membrane plants and possibly from some older distillation plants. In terms of key contaminants of direct interest for health and environment, the most important is probably boron, which can be of significance in reverse osmosis plants since the rejection ratio of boron (probably mostly as borate) is less than that for most other inorganic determinands. Bromide is initially present in seawater in relatively large amounts (~70 to 80 mg/L), so even high (eg, >95 percent) percentage removals will allow some bromide of the order of 1 to several mg/L to be present in the finished water.

RO has been shown to remove bacteria and larger pathogens and, depending on the membrane applied, to remove all or a large fraction of viruses. High-quality RO processes are good treatment barriers to pathogens if properly selected and maintained.

Most vegetative pathogens are inactivated under flash pasteurisation conditions (temperature of 72°C for 15 seconds). The condensate is unlikely to contain pathogens after the distillation process because of the killing impact of heat and because pathogens are unlikely to be entrained. However, reduced pressures are used in some desalination processes to reduce the boiling point and reduce energy demand. Temperatures as low as 50°C may be used which might not achieve the required inactivation targets. Inactivation levels expected at temperatures typical of distillation processes are considered sufficient to inactivate most pathogens since they are equivalent or in excess to those used for pasteurisation.

Chlorine in various forms (sodium hypochlorite, chlorine gas) is generally used for disinfection because of its recognised efficiency as a disinfectant and because of the reduced level of disinfection by-product precursors. Protozoa have generally been removed in the desalination process.

Desalinated water is initially more corrosive than many other drinking-water sources, and it is important that the water be stabilised to minimise its corrosive effect on pipes and fittings used in distribution and plumbing systems in buildings, and/or that the materials used in contact with the water be selected with care. The Israeli Ministry of Health has announced that it intends to require water providers to supplement desalinated water with magnesium in order to prevent the potential adverse effects of magnesium deficiency (taken from WQRA 2011). See Spungen et al (2013) for a discussion on health issues related to drinking desalinated water without supplementary calcium and magnesium.

## References

- American Society of Civil Engineers, Environmental Engineering Division. 1991. *Slow Sand Filtration*. GS Logsdon (ed). New York: ASCE. 0-87262-847-7, 230 pp.
- ANSI/AWWA B101-12. *AWWA Standard for Precoat Filter Media*.
- ANSI/AWWA B110-09. *AWWA Standard for Membrane Systems (9/4/2009)*.
- ANSI/AWWA B130-13. *AWWA Standard for Membrane Bioreactor Systems*.
- ANSI/AWWA B604-12. *AWWA Standard for Granular Activated Carbon*.
- ANSI/AWWA B605-13. *AWWA Standard for Reactivation of Granular Activated Carbon*.
- AS/NZS 4348:1995. *Water Supply: Domestic type water treatment appliances – Performance requirements*.
- AS/NZS 3497:1998. *Drinking Water Treatment Units: Plumbing requirements*.
- AWWA. 1990. *Water Quality and Treatment (4th edition)*. McGraw-Hill Inc.
- AWWA. 1995. *Precoat Filtration (2nd edition)*. Manual M30. Denver CO: American Water Works Association.
- AWWA. 1999. *Reverse Osmosis and Nanofiltration (1st edition)*. Manual M46. Denver CO: American Water Works Association.

AWWA. 2005. *Microfiltration and Ultrafiltration Membranes for Drinking Water*. Manual M53. Denver CO: American Water Works Association. Summarised in *J AWWA* 2008 100(12): 84–97.

Bonny E, Cameron D. 1998. Woodville's diatomaceous earth plant. *Water & Wastes in New Zealand* 101: 20–2.

Brown TS, Malina JF Jr, Moore BD. 1974. Virus removal by diatomaceous-earth filtration – Part 2. *Journal of the American Water Works Association* 66(12): 735–8.

Cotte, et al. 2005. Distributed Water Quality after Three Years of Nanofiltration, pp 143–56. *Water Quality in the Distribution System*. Denver CO: American Water Works Association.

Drinking Water Inspectorate (DWI). 2011. *List of Approved Products for Use in Public Water Supply in the United Kingdom*. London: Department for Environment, Food and Rural Affairs. See [www.dwi.gov.uk](http://www.dwi.gov.uk) or <http://dwi.defra.gov.uk/drinking-water-products/approved-products/solistcurrent.pdf>.

EPA/NSF ETV. 2002. *Protocol for Equipment Verification Testing for Physical Removal of Microbiological and Particulate Contaminants*. NSF International, Ann Arbor, MI for USEPA.

EPA/NSF ETV. 2005. *Protocol for Equipment Verification Testing for Physical Removal of Microbiological and Particulate Contaminants*. 40 CFR 35.6450. NSF International, Ann Arbor, MI for USEPA. <http://www.epa.gov/etv/pubs/059205epadwctr.pdf>.

Lang KP, et al. 1986. Diatomaceous earth filtration of *Giardia* cysts and other substances. *Journal of the American Water Works Association* 78(1): 76–84.

The New Zealand Ministry of Health's Guides for drinking-water supplies can be accessed as Word documents on the Ministry of Health website: <http://www.health.govt.nz/water> then select publications and Water Safety Plans.

Ministry of Health. *Public Health Risk Management Plan Guide PHRMP Ref: P6.2. Filtration – Slow Sand Filtration*. Wellington: Ministry of Health.

Ministry of Health. *Public Health Risk Management Plan Guide PHRMP Ref: P6.3. Treatment Processes – Cartridge Filtration*. Wellington: Ministry of Health.

Ministry of Health. *Public Health Risk Management Plan Guide PHRMP Ref: 6.4. Filtration – Diatomaceous Earth*. Wellington: Ministry of Health.

Ministry of Health. *Public Health Risk Management Plan Guide PHRMP Ref: P6.5. Treatment Processes – Membrane*. Wellington: Ministry of Health.

Ministry of Health. *Public Health Risk Management Plan Guide PHRMP Ref: P10. Treatment Processes – Pump Operation*. Wellington: Ministry of Health.

Ministry of Health. *Public Health Risk Management Plan Guide PHRMP Ref: P11. Treatment Processes – Plant Construction and Operation*. Wellington: Ministry of Health.

Ministry of Health. 2005. *Drinking-water Standards for New Zealand 2005, revised 2008*. Wellington: Ministry of Health.



NSF/ANSI 53-2002 (plus Addenda 1 and 2). *Drinking-water Treatment Units Health Effects*. Ann Arbor MI. Note that NSF are continually updating their standards. The latest version is: NSF/ANSI 53-2009e: *Drinking Water Treatment Units: Health effects* (23rd edition), 120 pp.

NSF. 2005. *Feasibility of an Economically Sustainable Point-of-Use/Point-of-Entry Decentralized Public Water System*. NSF International for USEPA. Available online at: [http://www.nsf.org/business/drinking\\_water\\_treatment/GrimesFinalReport\\_Dec05.pdf](http://www.nsf.org/business/drinking_water_treatment/GrimesFinalReport_Dec05.pdf).

Ogilvie D. 1998. Diatomaceous earth treatment. *Water & Wastes in New Zealand* 101: 17–18.

Ongerth J, Hutton P. 1997. DE filtration to remove *Cryptosporidium*. *J AWWA* 89(12): 39–46.

Schijven JF, et al. 2012. A mathematical model for removal of human pathogenic viruses and bacteria by slow sand filtration under variable operational conditions. *Water Research* 47: 2592–1602.

Schuler PF, Ghosh MM. 1990. Diatomaceous earth filtration of cysts and other particulates using chemical additives. *Journal of the American Water Works Association* 82(12): 67–75.

Spungen JH, et al. 2013. Desalination of water: nutritional considerations. *Israel Medical Association Journal* 15(4): 164–8.

USEPA. 1984. *Design Manual: Removal of fluoride from drinking water supplies by activated alumina*. Rubel and Hagler, Inc. under contract 68-03-2917 for USEPA ORD.

USEPA. 2003a.\* *Membrane Filtration Guidance Manual*. Proposal Draft, June. United States Environment Protection Agency. The draft version is/was available at: [http://www.epa.gov/safewater/lt2/pdfs/guide\\_lt2\\_membranefiltration\\_draft.pdf](http://www.epa.gov/safewater/lt2/pdfs/guide_lt2_membranefiltration_draft.pdf) see USEPA (2005) for latest version.

USEPA. 2005.\* Note: the final Guidance Manual (USEPA Office of Water, EPA 815-R-06-009) was published in November 2005 and can be accessed at [http://www.epa.gov/ogwdw/disinfection/lt2/pdfs/guide\\_lt2\\_membranefiltration\\_final.pdf](http://www.epa.gov/ogwdw/disinfection/lt2/pdfs/guide_lt2_membranefiltration_final.pdf) or go to <http://www.epa.gov/lawsregs/rulesregs/sdwa/lt2/compliance.cfm>.

USEPA. 2003b. *Long Term 2 Enhanced Surface Water Treatment Rule: Toolbox guidance manual*, Chapter 8: Bag and Cartridge Filters. Draft. EPA-815-D-03-009. Washington: United States Environmental Protection Agency. See USEPA (2009) for latest version.

USEPA. 2003c. *Arsenic Treatment Technology Evaluation Handbook for Small Systems*. USEPA, Office of Water, EPA 816-R-03-014. 151 pp. Available at: <http://water.epa.gov/lawsregs/rulesregs/sdwa/arsenic/compliance.cfm>.

USEPA. 2003d. *Small Drinking Water Systems Handbook: A guide to 'packaged' filtration and disinfection technologies with remote monitoring and control tools*. EPA/600/R-03/041. Office of Research and Development. Water Supply and Water Resources Division, United States Environmental Protection Agency. 73 pp. See: <http://www.epa.gov/ordntrnt/ORD/NRMRL/pubs/600r03041.html>.

USEPA. 2004. Protocol for Equipment Verification Testing of Volatile Organic Chemical Removal. Environmental Technology Verification Protocol (ETV). 04/9209/EPADWCTR. Prepared by NSF. 138 pp. <http://www.epa.gov/etv/pubs/049209epadwctr.pdf>.

USEPA. 2006. *Investigation of the Capability of Point-of-Use/Point-of-Entry Treatment Devices as a Means of Providing Water Security*. EPA/600/R-06/012, February 2006. 54 pp. USEPA, Office of Research and Development, National Homeland Security Research Center. See <http://www.epa.gov/nhsrsrc/pubs.html>.

USEPA. 2006a. *National Primary Drinking Water Regulations: Long Term 2 Enhanced Surface Water Treatment Rule: Final Rule*. (LT2ESWTR). Federal Register Part II, 40 CFR Parts 9, 141 and 142. Washington: National Archives and Records Administration. See <http://www.epa.gov/fedrgstr/EPA-WATER/2006/January/Day-05/w04a.pdf> <http://www.epa.gov/fedrgstr/EPA-WATER/2006/January/Day-05/w04b.pdf> <http://www.epa.gov/fedrgstr/EPA-WATER/2006/January/Day-05/w04c.pdf> or go to <http://www.epa.gov/lawsregs/rulesregs/sdwa/lt2/compliance.cfm>.

USEPA. 2009. *Long Term 2 Enhanced Surface Water Treatment Rule, Toolbox Guidance Manual Review Draft*. Go into <http://www.epa.gov/safewater/disinfection/lt2/> and then enter: toolbox guidance manual review draft in the 'search' box. See USEPA (2010) for Final.

USEPA. 2010. *Long Term 2 Enhanced Surface Water Treatment Rule, Toolbox Guidance Manual*. EPA-815-R-09-016. 375 pp. [http://www.epa.gov/safewater/disinfection/lt2/pdfs/guide\\_lt2\\_toolboxguidance\\_manual.pdf](http://www.epa.gov/safewater/disinfection/lt2/pdfs/guide_lt2_toolboxguidance_manual.pdf) or try <http://nepis.epa.gov/Exe/ZyPDF.cgi?Dockkey=P1009JLI.txt>.

WHO. 1974. *Slow Sand Filtration*. ISBN 92 4 154 037 0. 122 pp. Out of print. Available only in electronic form: [http://www.who.int/water\\_sanitation\\_health/publications/ssf/en/index.html](http://www.who.int/water_sanitation_health/publications/ssf/en/index.html).

WHO. 2004. *Guidelines for Drinking-water Quality* (3rd edition). Geneva: World Health Organization. Available at: [www.who.int/water\\_sanitation\\_health/dwq/gdwq3/en/print.html](http://www.who.int/water_sanitation_health/dwq/gdwq3/en/print.html) see also the addenda.

WHO. 2004a. *Water Treatment and Pathogen Control: Process efficiency in achieving safe drinking water*. MW LeChevallier, K-K Au. 136 pp. Published on behalf of WHO by IWA Publishing. Available at: [www.who.int/water\\_sanitation\\_health/publications/en/index.html](http://www.who.int/water_sanitation_health/publications/en/index.html).

WHO. 2005. *Nutrients in Drinking-water*. WHO/SDE/WSH/05.09, 210 pp. See Chapter 2: Health Risks from Drinking Demineralised Water. Available at: [http://www.who.int/water\\_sanitation\\_health/dwq/nutrientsindw/en/index.html](http://www.who.int/water_sanitation_health/dwq/nutrientsindw/en/index.html).

WHO. 2007. *Desalination for Safe Water Supply*. World Health Organization, Geneva. 173 pp. [www.who.int/water\\_sanitation\\_health/gdwqrevision/desalination.pdf](http://www.who.int/water_sanitation_health/gdwqrevision/desalination.pdf).

WHO. 2009. *Scaling Up Household Water Treatment Among Low-Income Populations*. 84 pp. [http://whqlibdoc.who.int/hq/2009/WHO\\_HSE\\_WSH\\_09.02\\_eng.pdf](http://whqlibdoc.who.int/hq/2009/WHO_HSE_WSH_09.02_eng.pdf).

WHO. 2011. *Guidelines for Drinking-water Quality 2011* (4th edition). Geneva: World Health Organization. Available at: [http://www.who.int/water\\_sanitation\\_health/publications/2011/dwq\\_guidelines/en/index.html](http://www.who.int/water_sanitation_health/publications/2011/dwq_guidelines/en/index.html).

WHO. 2011a. *Safe Drinking-water from Desalination: Guidance on risk assessment and risk management procedures to ensure the safety of desalinated drinking-water*. Geneva: World Health Organization. WHO/HSE/WSH/11.03. 34 pp.

[http://www.who.int/water\\_sanitation\\_health/publications/2011/desalination\\_guidance/en/index.html](http://www.who.int/water_sanitation_health/publications/2011/desalination_guidance/en/index.html).

WHO. 2017. *Guidelines for Drinking-water Quality: Fourth edition incorporating the first Addendum*. Geneva: World Health Organization. 631 pp.

[http://www.who.int/water\\_sanitation\\_health/publications/drinking-water-quality-guidelines-4-including-1st-addendum/en/](http://www.who.int/water_sanitation_health/publications/drinking-water-quality-guidelines-4-including-1st-addendum/en/).

WQRA. 2011. *HealthStream – Quarterly Public Health Newsletter of Water Quality Research Australia*. March issue. [www.wqra.com.au](http://www.wqra.com.au).

WRF. 2016. *Chemically Enhanced Biological Filtration to Enhance Water Quality and Minimize Costs*. [Project #4429A & B]. Water Research Foundation.

<http://www.waterrf.org/Pages/Projects.aspx?PID=4429>.

# Chapter 15: Treatment processes, disinfection

## Contents

|             |  |           |
|-------------|--|-----------|
| <b>15.1</b> | <b>Introduction</b>                      | <b>3</b>  |
| <b>15.2</b> | <b>Disinfection effectiveness</b>        | <b>5</b>  |
| 15.2.1      | C.t values                               | 7         |
| 15.2.2      | Disinfectant concentration               | 8         |
| 15.2.3      | Nature of the disinfectant               | 8         |
| 15.2.4      | Type of micro-organisms present          | 9         |
| 15.2.5      | pH                                       | 10        |
| 15.2.6      | Temperature                              | 10        |
| 15.2.7      | Water quality                            | 10        |
| 15.2.8      | Regrowth                                 | 11        |
| 15.2.9      | Disinfectant mixing and retention time   | 12        |
| <b>15.3</b> | <b>Choice of disinfectant</b>            | <b>15</b> |
| <b>15.4</b> | <b>Disinfection by-product formation</b> | <b>17</b> |
| 15.4.1      | Introduction                             | 17        |
| 15.4.2      | Formation                                | 18        |
| 15.4.3      | Toxicity                                 | 22        |
| 15.4.4      | Occurrence                               | 22        |
| 15.4.5      | Booster chlorination                     | 23        |
| 15.4.6      | DBPs found to date                       | 23        |
| 15.4.7      | Further reading                          | 28        |
| <b>15.5</b> | <b>Disinfection processes</b>            | <b>29</b> |
| 15.5.1      | Chlorine                                 | 29        |
| 15.5.2      | Chloramines                              | 35        |
| 15.5.3      | Chlorine dioxide                         | 41        |
| 15.5.4      | Ozone                                    | 46        |
| 15.5.5      | Ultraviolet disinfection                 | 54        |
| 15.5.6      | Bromine                                  | 67        |
| 15.5.7      | Iodine                                   | 68        |

|                   |  |           |
|-------------------|--|-----------|
| 15.5.8            | Potassium permanganate                 | 70        |
| 15.5.9            | Hydrogen peroxide                      | 71        |
| 15.5.10           | Silver and other metal ions            | 71        |
| 15.5.11           | Advanced oxidation processes           | 73        |
| 15.5.12           | Mixed oxidants (chlorine-based)        | 74        |
| 15.5.13           | Membrane technologies                  | 75        |
| 15.5.14           | Sunlight (solar disinfection or SODIS) | 75        |
| 15.5.15           | Heat                                   | 78        |
| <b>References</b> |  | <b>78</b> |

### List of tables

|              |   |    |
|--------------|---|----|
| Table 15.1:  | C.t value ranges for 99 percent (2 log) inactivation of various micro-organisms by disinfectants at 5°C | 9  |
| Table 15.2:  | Baffle factors for use in measuring detention time  | 13 |
| Table 15.3:  | Characteristics of different disinfectants  | 17 |
| Table 15.4:  | Disinfection by-products often present in disinfected waters  | 25 |
| Table 15.5:  | Chlorine C.t values for 99 percent inactivation (2 logs)  | 29 |
| Table 15.6:  | Variation of hypochlorous acid and hypochlorite ion with pH   | 30 |
| Table 15.7:  | Monochloramine C.t values for 99 percent inactivation (2 logs)  | 35 |
| Table 15.8:  | Chlorine dioxide C.t values for 99 percent inactivation (2 logs)  | 41 |
| Table 15.9:  | Ozone C.t values for 99 percent inactivation (2 logs)   | 47 |
| Table 15.10: | UV irradiation doses required for 99 percent inactivation (2 logs)                                      | 56 |
| Table 15.11: | UV dose (mJ/cm <sup>2</sup> ) for inactivation of protozoa and viruses                                  | 57 |

### List of figures

|              |  |    |
|--------------|--|----|
| Figure 15.1: | Baffle characteristics of a pipe and tank                                    | 14 |
| Figure 15.2: | The effect of chlorine to nitrogen ratios in producing chloramines compounds | 37 |
| Figure 15.3: | Distribution diagram for chloramine species with pH                          | 38 |

## 15.1 Introduction

To comply with the bacterial criteria of the *Drinking-water Standards for New Zealand 2005 revised 2008* (DWSNZ), all water supplies must be disinfected (section 4 of DWSNZ), except for bore waters that are shown to be secure (section 4.5 of DWSNZ). Refer to Chapter 3: Source Waters, section 3.2 for a discussion on demonstrating security of bore water. Some disinfection processes can also be used to achieve protozoal compliance.

The microbiological quality of drinking-water is the factor of most universal concern regarding the acceptability of a water for human consumption. The impact of poor microbiological quality on public health usually becomes evident to consumers much more rapidly than do the consequences of elevated levels of chemical contaminants of health significance. Consuming a glass of drinking-water containing disease-causing micro-organisms may affect one's health within a short time, whereas the chemical MAVs are based on the possible effects of an individual drinking two litres a day for 70 years.

Good microbiological quality of water at the consumer's tap is most reliably achieved by ensuring that the water entering the distribution system is microbiologically safe, and that there is a residual disinfectant in the distribution system to minimise the impact of any regrowth or contamination that enters the distribution system.

The ideal disinfectant should:

- effectively inactivate pathogens over a range of physical and chemical conditions
- produce a disinfectant residual which is stable and easily measured
- produce no undesirable by-products
- be easily generated, safe to handle, and suitable for widespread use
- be cost-effective
- be aesthetically acceptable.

No disinfectant presently in use meets all these requirements. Some compromises have to be made, and the characteristics of the particular supply and its water quality will govern the relative importance of these factors. Although secure bore waters do not need to be disinfected to ensure that safe water is entering the distribution system, without a disinfecting residual, the risk from subsequent contamination in the distribution system is increased. This increased risk is reflected in the criteria used for the allocation of grades during the water supply grading programme.

Where a water is treated by a disinfectant alone, total reliance is being placed on the disinfecting ability of that disinfectant to achieve safe drinking-water. More complete treatment takes advantage of other processes to aid in removing micro-organisms from the water, thereby increasing the number of barriers to infection and reducing the demands made on the microbial inactivation rates of the disinfectant. The benefit of multiple barriers is applied when allowing protozoal credits for some treatment processes to be added.

The most commonly used disinfectant, both in New Zealand and overseas, is chlorine, and the term chlorination is often used interchangeably with disinfection. The use of alternative disinfectants such as ozone, chlorine dioxide, and ultraviolet light has increased in recent years, mainly because they can also inactivate *Cryptosporidium* oocysts. These disinfectants will probably not displace chlorine because of the advantage in maintaining a FAC residual through the distribution system. They may also reduce the formation of the health-significant disinfection by-products associated with the use of chlorine in waters containing significant levels of natural organic matter. It is possible to maintain a chlorine dioxide residual throughout the distribution system, but often the dose required to do this results in the chlorite by-product exceeding its MAV of 0.8 mg/L, see section 15.5.3. WHO (2004b) discusses treatment processes suitable for pathogen control.

The EPA in Ireland (2011) produced their Water Treatment Manual: Disinfection. Water UK (2010) has summarised some check points for disinfection processes. DWI (2011) has prepared a list of disinfectants approved for use in water supplies in the UK.

The formation of disinfection by-products linked to chlorine can be reduced by improved chlorination practices, selection of different raw water sources, reduction in the levels of organic matter in the water prior to chlorination, or the use of alternative disinfectants. All disinfectants, except ultraviolet light, for which research has still to be undertaken, produce their own by-products of health significance. It is important, therefore, that the consequences of the use of an alternative disinfectant, especially with regard to its effect on the quality of the water to be treated, are investigated before resources are invested in its use.

In Peru (Anderson 1991) concerns about chlorine disinfection by-products led to the authorities discontinuing chlorination, which resulted in a major cholera epidemic spreading via the water supply. Regli et al (1993) concluded:

“the risk of death from known pathogens in untreated water is 100 to 1000 times greater than risk of cancer from known disinfection by-products in chlorinated drinking water, and the risk of illness from pathogens in untreated surface water is 10 000 to 1 000 000 times greater than risk of cancer from disinfection by-products in chlorinated drinking water”.

Note also that a microbiological problem can be caused in a matter of hours, whereas chemical MAVs are based on drinking 2 litres of water a day for a lifetime. Note further that turning a chlorinator off because of perceived issues related to oxidation of iron and manganese (for example), or the public's dislike of the taste/odour, is inviting microbiological problems.

Some process variation is normal and expected; however, too much variability can result in disinfection failures, leading to waterborne disease outbreaks. An objective of the DWSNZ, therefore, is to keep process variability within acceptable limits. Understanding the causes of process variations should prevent recurrences.

The following sections provide background information about disinfection and disinfectants that will act as a basic guide to their selection and use.

Risk management issues related to the disinfection processes covered in this chapter are discussed in the:

- MoH Public Health Risk Management Plan Guide PHRMP Ref: P7.1: Treatment Processes – Chlorine Disinfection
- MoH Public Health Risk Management Plan Guide PHRMP Ref: P7.2: Treatment Processes – Chlorine Dioxide Disinfection
- MoH Public Health Risk Management Plan Guide PHRMP Ref: P7.3: Treatment Processes – Ozone Disinfection
- MoH Public Health Risk Management Plan Guide PHRMP Ref: P7.4: Treatment Processes – Ultraviolet Irradiation Disinfection
- MoH Public Health Risk Management Plan Guide PHRMP Ref: P8.1: Treatment Processes – pH Adjustment
- MoH Public Health Risk Management Plan Guide PHRMP Ref: P11: Treatment Processes – Plant Construction and Operation.

Refer to Chapter 13: Treatment Processes: Coagulation and Filtration, section 13.1: Introduction, for a discussion on keeping records of all chemicals used in water treatment.

The 2008 DWSNZ include a new section, section 5.17: Alternative processes: treatment compliance criteria, whereby water suppliers may apply to the Ministry of Health to have other treatment processes assessed for a log credit rating. This approach, which is explained more fully in section 8.4.5 of the Guidelines, allows water suppliers to apply for a log credit rating (or a variation to the prescribed log credits) for a treatment plant or process:

- a) not covered in sections 5.1–5.16 of the DWSNZ
- b) that performs demonstrably better than its compliance criteria
- c) that performs to a lesser, but reliable, level than specified in its compliance criteria.

See <http://www.awwa.org/files/Resources/Standards/StandardsSpreadsheet.xls> for a list of AWWA Standards and Manuals covering disinfection, and the chemicals used for disinfection.

## 15.2 Disinfection effectiveness

A number of factors influence the effectiveness of disinfection. Some are applicable to all disinfectants, while others are more specific.

### Bacteria

Reliable testing of pathogenic bacteria is a slow and expensive process for monitoring the microbiological quality of a water on a frequent basis. Therefore an indicator bacterium is used to assess bacterial quality, see Chapter 5: Microbiological Quality: section 5.3 for information about indicator organisms. The maximum acceptable value (MAV) for bacteria is less than 1 *E. coli* per 100 mL.



Testing for *E. coli* performs checks on the effectiveness of bacterial disinfection. Although the presence of a disinfectant residual does not guarantee that the water is microbiologically safe, it does greatly improve the likelihood that the water will be satisfactory. Frequent monitoring of the disinfectant dosage and its residual is therefore important as it provides a rapid and cheap means of supplementing the results of the less frequent microbiological sampling. Accurate methods of measuring the disinfectant residual are therefore important, and these are discussed in each of the sections dedicated to the individual disinfectants.

Measurement of the chlorine (or chlorine dioxide) residual only where it leaves the treatment plant is insufficient. In most instances the residual continues to decay as the water passes through the distribution system. This is in part due to both on-going reactions with impurities in the water and with substances adhering to, or growing on, the distribution system pipes.

Chlorine (or chlorine dioxide) residual measurements therefore need to be made occasionally at the most distant point in the distribution system. This will allow residuals at the extremes of the distribution system to be estimated from residual measurements at the plant. Changes in the disinfectant demand of the raw water will upset this relationship, and free available chlorine (FAC) measurements at the distribution system extremities should be made more frequently when significant changes in water quality occur. Some allowance for water quality changes can be made by operating with an FAC near the top end of the acceptable range.

## Viruses

The DWSNZ do not have a MAV for viruses. However, it is considered that drinking-water with less than 1 *E. coli* per 100 mL and with a residual of at least 0.2 mg/L of free available chlorine (FAC) should be effective in inactivating viruses, see Chapter 7: Virological Compliance, section 7.6 for a limited discussion on C.t values.

## Protozoa

The drinking-water MAV for total pathogenic protozoa is less than 1 infective (oo)cyst per 100 litres. Checks on the effectiveness of protozoal disinfection cannot be performed routinely by testing for *Giardia* or *Cryptosporidium*. Therefore the DWSNZ have defined a set of criteria for each treatment process that is known to remove or inactivate protozoa, refer to Chapter 8: Protozoa Compliance. These include chemical coagulation with filtration, some filtration processes, and some disinfection processes. The coagulation/filtration and filtration processes are discussed in their relevant treatment chapters, Chapters 13 and 14. Disinfection processes used to inactivate protozoa are discussed in this chapter.

## 15.2.1 C.t values

In a good quality water (if the pH and temperature are fairly consistent, and if the disinfectant mixes with the water efficiently), the extent to which a microbial population is inactivated depends on the concentration of the disinfectant and the time the micro-organisms are exposed to it. After the water has been dosed with disinfectant the number of viable organisms remaining is expected to decrease exponentially with time. In practice, these ideal conditions are not maintained, and there are deviations from theoretical behaviour.

It has been found experimentally that the contact time,  $t$ , required to achieve a 99.6 to 100 percent inactivation of micro-organisms is related to the concentration,  $C$ , of disinfectant used, by the equation:

$$t = \text{constant} \times C^n$$

Reported values for  $n$  range from 0.5 to 1.8 for most aqueous disinfectants. Generally, however,  $n$  approximates 1, and the equation is simplified to:

$$C \times t = \text{constant.}$$

Although this relationship is an approximation, and there are deviations from it, an estimate of the constant, or C.t value, is useful:

- C.t values provide an indication of the strength of the disinfectant; for the same micro-organism, strong disinfectants possess low C.t values and poor disinfectants require high C.t values
- for the same disinfectant and different organisms, C.t values give a measure of the resistance of different organisms to that disinfectant
- required contact times to achieve the required percentage inactivation at a particular disinfectant concentration can be calculated from C.t values. Viewed differently, the concentration required to achieve inactivation within a target contact time can be calculated.

The C.t values for inactivation of *Cryptosporidium* by chlorine dioxide and ozone appear in Tables 5.5 and 5.6 respectively in DWSNZ 2005. C.t tables for chlorine and *Giardia* were in the DWSNZ 1995.

As an example of how to use C.t tables, consider the calculation for inactivating pathogenic protozoa using ozone. Table 5.6 in the DWSNZ shows that to earn 3 log credits using ozone at 15°C, the C.t value is 19 min.mg/L. That means if the retention time in the ozone reactor is 19 minutes, the residual at the point of measurement must be at least 1 mg/L ozone. Or for a retention time of 9.5 minutes, the residual must be 2 mg/L.

## 15.2.2 Disinfectant concentration

The higher the concentration of the disinfectant residual in the water the more rapidly inactivation is achieved. Using Table 5.5 in the DWSNZ for 3 logs inactivation of *Cryptosporidium* oocysts by chlorine dioxide, we see that the C.t value at 15°C is 536 min.mg/L. So if the residual leaving the treatment plant is 0.3 mg/L the contact time needs to have been about 30 hours (ie, 536/0.3 minutes), but this reduces to nine hours if the residual is 1.0 mg/L. Note that C is the residual, not the dose. Table 5.5 covers temperatures 1 to 25°C; USEPA (2009) includes <1 and 30°.

For disinfection efficiency, high disinfectant concentrations are desirable because they will ensure rapid microbial inactivation. However, the possible toxicity of the disinfectant, its impact on the taste and smell of the water, and any production of health significant by-products from its chemical reactions, need to be taken into consideration. Often, relatively long contact times are available that allow the use of low disinfectant concentrations and a reduction in the adverse effects of the disinfectant.

## 15.2.3 Nature of the disinfectant

The disinfecting power of a disinfectant varies with the disinfectant. Using C.t values for a qualitative estimation of disinfecting ability, the following order of disinfecting strength, from strongest to weakest, is generally true for most micro-organisms:

- 1 ozone
- 2 chlorine dioxide
- 3 chlorine
- 4 chloramines.

For UV disinfection, a parameter similar to C.t value provides an indication of disinfecting ability of the unit, but in this instance C is the UV dose (see section 15.5.5).

Table 15.1 (Hoff 1986, in WHO 2004), which summarises C.t values that have been determined for a number of micro-organisms and a series of disinfectants, demonstrates this approximate ranking. What is evident from the table is that the ranking is only approximate and that it may change with the organism concerned, and with temperature and pH.

**Table 15.1: C.t value ranges for 99 percent (2 log) inactivation of various micro-organisms by disinfectants at 5°C**

| Micro-organism               | Free chlorine<br>pH 6–7 | Pre-formed chloramine<br>pH 8–9 | Chlorine dioxide<br>pH 6–7 | Ozone<br>pH 6–7 |
|------------------------------|-------------------------|---------------------------------|----------------------------|-----------------|
| <i>E. coli</i>               | 0.034–0.05              | 95–180                          | 0.4–0.75                   | 0.02            |
| poliovirus 1                 | 1.1–2.5                 | 768–3740                        | 0.2–6.7                    | 0.1–0.2         |
| rotavirus                    | 0.01–0.05               | 3806–6470                       | 0.2–2.2                    | 0.006–0.6       |
| phage f <sub>2</sub>         | 0.08–0.18               | –                               | –                          | –               |
| <i>G. intestinalis</i> cysts | 47–>150                 | –                               | –                          | 0.5–0.6         |
| <i>G. muris</i> cysts        | 30–630                  | –                               | 7.2–18.5                   | 1.8–2.0         |

Later data have become available. Some C.t values are similar, others quite different. The values depend on the contact time, pH, temperature, turbidity, the age or condition of the organisms, the ammonia and natural organic matter concentrations in the water, and basic test methodology. A safety factor has been incorporated in some C.t values, being the difference between experimental data and compliance values. Some test results refer to bacteria or viruses without stating which species were tested; in these situations it is often data from the more resistant members of the group that are quoted. To update Table 15.1, some later data from WHO (2004) have been included in the relevant disinfectant sections. WHO states that their data apply to micro-organisms in suspension, not embedded in particles or in biofilm.

## 15.2.4 Type of micro-organisms present

There are three main groups of pathogenic (disease-causing) micro-organisms that are of importance in potable waters in New Zealand. These are bacteria, viruses, and protozoal cysts or oocysts. Generally speaking, the resistance of these organisms to disinfectants decreases in the order: (oo)cysts are more resistant than viruses, which are more resistant than bacteria. Resistance to disinfectants also varies from species to species in each group.

Certain bacteria show a high level of resistance to disinfection processes. Spore forming bacteria such as *Bacillus* or *Clostridium* are highly resistant when disseminated as spores. Acid-fast and partially acid-fast bacteria such as *Mycobacterium* and *Nocardia* can also be highly resistant to chlorine disinfection. One study showed that nearly all of the bacteria surviving chlorine disinfection were Gram positive or acid fast, possibly because Gram-positive bacteria have thicker walls than Gram-negative ones (WHO 2004b).

The disease caused by the micro-organisms is as a result of ingestion. Diseases caused by inhalation of water while showering or due to faulty maintenance in some air conditioning systems, can be caused by *Legionella*, but are not covered in the DWSNZ; these are covered by other legislation such as the Building Act. However, a datasheet has been prepared for *Legionella*.

Cyanobacteria can also cause illness due to ingestion of their toxins. It is generally inadvisable to employ disinfectants to control cyanobacteria as their cells break up on death resulting in the release of the toxins. Oxidising disinfectants can, however, be used to destroy toxins present in the water, after any cells have been removed, see Chapter 9: Cyanobacteria Compliance.

## 15.2.5 pH

The impact of pH on disinfection depends on the disinfectant. For some disinfectants, such as chlorine, disinfecting efficiency is strongly pH dependent because the form of the disinfectant in the water changes with pH, see section 15.5.1. This is why the DWSNZ refer to FACE (free available chlorine equivalent) when discussing inactivation of bacteria by chlorination in water leaving the treatment plant.

Tables 12.1–12.6 in *Drinking-water Standards for New Zealand 1995* took this into account by providing C.t values for a number of pH ranges, and it can be seen that much longer contact times are required for the same degree of inactivation of *Giardia* at high pH compared with low pH.

Slight pH effects are noted for other disinfectants, despite there being no chemical change in the disinfectant. In these cases, the pH level may affect the susceptibility of the organism to the disinfectant.

## 15.2.6 Temperature

Disinfection processes (chemical and UV light) behave in many respects as chemical reactions. Higher temperatures therefore bring about an increase in the effectiveness of disinfection, in the absence of complicating factors. Conversely, the high doses or contact times needed to inactivate protozoa in very cold water may render the process uneconomic. For example, to gain 3 log credits using ozone, the C.t at 5°C is four times that required at 20°C.

## 15.2.7 Water quality

Water quality can have a major impact on the disinfection process in a number of ways.

Micro-organisms are able to adsorb on to or become occluded in suspended particulate matter, which affords them protection from disinfecting agents. Treatment processes should therefore reduce turbidity to as low a level as possible before the disinfectant is added. That is why turbidity requirements are specified as part of the bacterial and protozoal compliance criteria for disinfectants in the DWSNZ.

Dissolved and particulate constituents in the water may consume the disinfectant. These constituents make up the chemical disinfectant demand. The disinfectant demand is important because it is the disinfectant residual in the water, eg, the concentration of free available chlorine, not the disinfectant dose that determines the efficacy of a disinfectant. Sufficient disinfectant must therefore be added to the water to allow for the disinfectant demand reactions to occur, and still ensure that an adequate disinfecting residual is present.

For chemical disinfectants that are not intended to operate with a residual entering the distribution system, ie, ozone, this increased demand still requires a high dose in order to satisfy the C.t.

Some dissolved and particulate constituents in the water may absorb or scatter UV light so that less UV reaches the intensity meter. This too requires an increased dose to compensate. Some substances eg, lime or iron and manganese, can plate out on the UV appliance, thereby reducing the amount of UV light that enters the water flowing through.

Disinfectant demand reactions may produce substances that are undesirable for health reasons but this should not be a reason for stopping disinfection (section 15.1 and 15.4), or they may adversely affect the power of the disinfectant by destroying it, or by converting it to a less biocidal compound, eg, the formation of chloramines (see sections 15.5.1 and 15.5.2).

Because of the bearing that the water quality has on the disinfection process, the point at which the disinfectant is added in the treatment process is important. As a general rule, the later in the process the disinfectant is added, the higher the quality of the water it will be treating and the fewer the accompanying problems. Disinfectant consumption is lower, and hence so are treatment costs. Further, disinfection by-products are minimised and tastes and odours should be reduced.

Algae may plague some treatment plants at certain times of the year, or there may be problems with the development of other microbiological growths in the plant. Under these circumstances pre-oxidation/disinfection may need to be used, but other ways of eliminating biological problems should be sought before turning to pretreatment with disinfectants, because of the possible release of toxins or taste and odour compounds from algae killed by the disinfectant.

## 15.2.8 Regrowth

Regrowth of micro-organisms in a distribution system may occur, even after disinfection. This is encouraged by nutrients in the water, elevated temperatures and long retention times. Some disinfectants, in their role as oxidants (eg, ozone), may exacerbate the problem of regrowth by converting complex natural organic matter in the raw water to smaller organic molecules that are more readily assimilated by micro-organisms.

The presence of a disinfecting residual is sometimes insufficient to control regrowth, see Chapter 16: The Distribution System. Micro-organisms adsorbed to the walls of distribution system pipes can be protected from disinfectant residuals in much the same way as organisms absorbed into or adsorbed on to turbidity particles. Adequate disinfectant residuals may be present in distribution systems, and bacterial counts in the bulk water generally low. However, occasionally, clumps of bacteria that are growing on the pipe walls may slough off into the bulk water and produce high, intermittent bacterial counts. See also Chapter 5: Microbiological Quality, section 5.5.

## 15.2.9 Disinfectant mixing and retention time

The effectiveness of the disinfection process is reduced if the hydraulics of the treatment plant do not allow adequate mixing of the disinfectant with the water, and hence with the micro-organisms. Poor mixing may result in the micro-organisms not being exposed to the disinfectant concentration, or for the required time, intended in the system design. Both will result in the inactivation rate being less than expected.

The disinfectant contact time ( $t$ ), also referred to as  $T_{10}$  in the *Guidance Manual for Compliance with the Filtration and Disinfection Requirements for Public Water Systems Using Surface Water* (USEPA 1991),<sup>1</sup> is an estimate of the detention time within a basin or treatment unit at which 90 percent of the water passing through the unit is retained within the basin or treatment unit.  $T_{10}$  can be determined through a tracer study (using dye, salt or lithium dilution testing) or estimated based on the theoretical detention time and baffling factor.

The theoretical detention time is the time that the water is in a basin, pipe, or unit process assuming perfect plug flow. Perfect plug flow assumes no short-circuiting within the basin, pipe, or unit process. The theoretical detention time is calculated by dividing the volume of the contact system based by the flow.

The volume of each contact basin, pipe, or unit process is used to calculate  $t$ . Some water treatment plants use the final water storage for some or all of the contact time. These can have fluctuating water levels that affect the volume. Allowance must be made for this. There are three options:

- 1 volumes can be based on the minimum volume that can occur in the treatment unit. This approach is the most conservative
- 2 volumes can be based on the actual volume realised in the treatment unit during peak hourly flow if adequate information is available to identify the actual volume
- 3 volumes can be based on the lowest volume realised in the treatment unit for that day.

<sup>1</sup> This reference was taken from the text of USEPA 2003d; another part of USEPA (2003) attributes it to AWWA 1991.

Tracer studies can be expensive so baffle factors have been developed that allow the detention time of a basin, pipe, or unit process to be estimated. Baffle factors were developed based on numerous tracer studies of basins with different sizes and configurations. Appendix C of the SWTR Guidance Manual covers this in detail. This was a 1991 publication; a lot of the same material was republished in the LT1ESWTR Disinfection Profiling and Benchmarking Technical Guidance Manual, which is available on the internet (USEPA 2003d); Chapter 4 and Appendix G are particularly useful.

**Table 15.2: Baffle factors for use in measuring detention time**

| Baffle condition       | Baffle factor | Baffle description  |
|------------------------|---------------|---|
| Unbaffled (mixed flow) | 0.1           | None, agitated basin, very low length to width ratio, high inlet and outlet flow velocities.              |
| Poor                   | 0.3           | Single or multiple unbaffled inlets and outlets, no intra-basin baffles.                                  |
| Average                | 0.5           | Baffled inlet or outlet with some intra-basin baffles.  |
| Superior               | 0.7           | Perforated inlet baffle, serpentine or perforated intrabasin baffles, outlet weir or perforated launders. |
| Perfect (plug flow)    | 1.0           | Very high length to width ratio (pipeline flow), perforated inlet, outlet, and intra-basin baffles.       |

From USEPA 2003d, see Figure 15.1 for pictorial examples.

The retention time (t, in minutes) can be calculated once the theoretical detention time (in minutes) and baffle factor are known:

$$\text{retention time (t)} = \text{theoretical detention time} \times \text{baffle factor}$$

Long lengths of pipe (plug flow) before the first consumer offer excellent conditions for an effective contact time, because the chance of short-circuiting is almost nil. Once the pipe widens to the dimensions of a tank, areas of low flow and dead space develop see Figure 15.1. This means that some existing tanks with a low length/width ratio need to have appropriately designed baffles fitted to attain the optimum effectiveness achievable with the available volume, also see Stevenson (1995).

Full, rapid mixing is especially important for short contact disinfectants such as ozone and UV light where there is no opportunity for prolonged contact to overcome poor initial mixing, as there is with disinfectants that provide a disinfecting residual.

There is the potential with an inadequately mixed chloramination process for taste and odour products to be formed, particularly dichloramine, see section 15.5.2.

An alternative approach to using lithium, salt or dye is to take advantage of chemicals already being used, such as fluoride or chlorine, either after the fluoride or chlorine had been turned off, or by monitoring a stepped change in dosage. The flow rate should be kept constant for the duration of the test. Ideally, tracer tests should be performed for a range of flow rates, and the duration of a tracer test is three times the theoretical hydraulic detention time. See USEPA (1999a) and EPA (2011) for further information. Appendix D in USEPA (1999a) includes a worked example of measuring contact time using fluoride dosage.



**Figure 15.1: Baffle characteristics of a pipe and tank**

**(a) Plug flow in a pipe – baffling factor = 1.0**

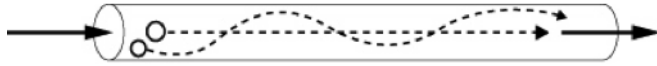

This pipe demonstrates a plug flow condition in which all of the material sent through the pipe discharges at the theoretical hydraulic detention time of the pipe.

**(b) A tank with no baffling – baffling factor = 0.1**

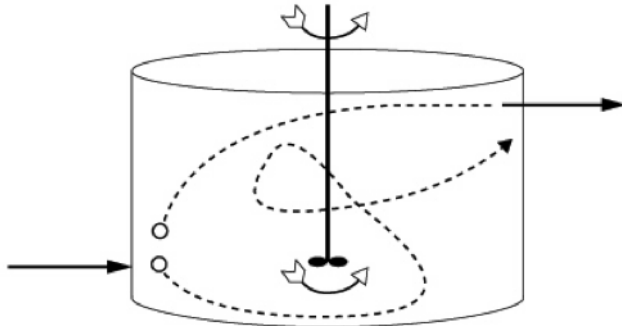

This unbaffled basin demonstrates short-circuiting in which some of the material entering the basin would come out almost immediately, while other material that enters at the same time will be detained for a longer period of time. Short-circuiting occurs in basins with poor baffling.

**(c) An average mixing tank**

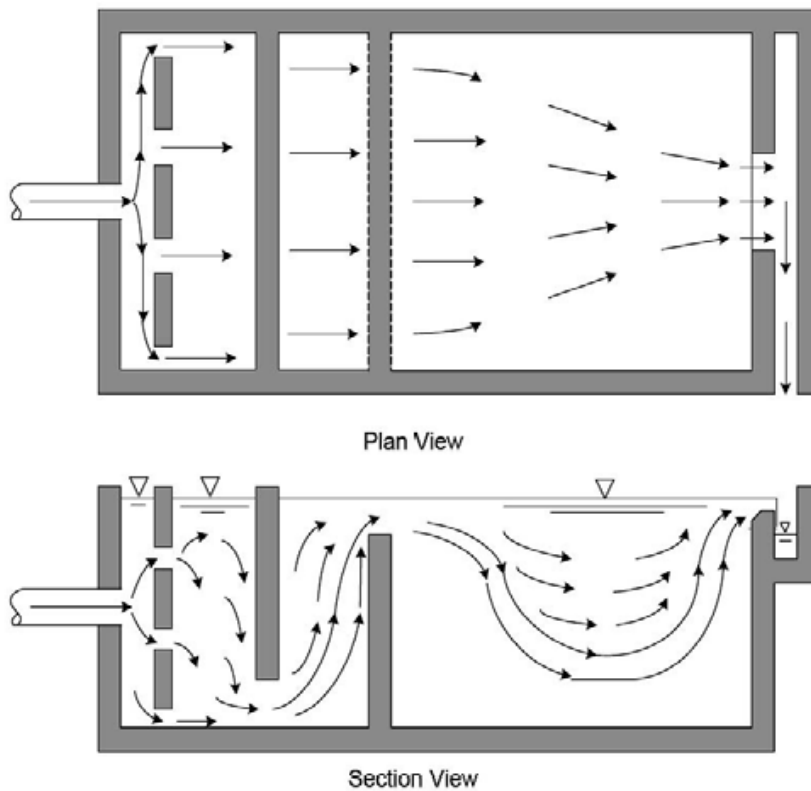

Average baffling conditions. A good contact tank will prevent jetting at the inlet, will distribute flow across the full width and depth, and prevent streaming at the outlet. From USEPA (1999a), which includes drawings and assessments of various designs of mixing tanks.

## 15.3 Choice of disinfectant

The choice of disinfectant depends on the source and quality of the raw water, any other water treatment processes installed, and the types of organisms that need to be inactivated. Some towns allow the public to influence the choice, usually on subjective issues.

The main disinfection process used in New Zealand is chlorination, for reasons of cost, reliability in inactivating bacteria (and most probably viruses), and its ability to provide a disinfectant residual throughout the distribution system. Other methods that are available include chloramine, chlorine dioxide, ultraviolet light, hydrogen peroxide, and ozone. Although not widely used in New Zealand, these alternative disinfectants have been used for one or more of the following reasons:

- improved disinfection efficacy
- reduction in the formation of disinfection by-products
- inactivation of protozoa
- other benefits to the treatment process (eg, reduction in taste and odours).

However, the choice of alternative disinfectants needs to be considered carefully as they all have advantages and disadvantages. For example ultraviolet light, hydrogen peroxide and ozone do not provide a residual disinfection effect, with the result that numbers of heterotrophic bacteria may actually increase after treatment. Heterotrophic bacteria are described in Chapter 5: Microbiological Quality, section 5.3.6: Indicators of general quality.

An understanding of the effects that the expected variations in water quality, such as temperature, pH, and the organic matter content, will have on the effectiveness of the disinfectant is imperative when planning and designing a disinfection system. All of these factors will affect system operations, such as disinfectant concentration/contact time and the mixing regime. Variations should be accounted for during design in order to maximise disinfection efficiency and to improve the aesthetic qualities of the water after disinfection.

Generally there is no disinfection system available that meets all of the ideal operational needs, so a compromise between certain features is required. Many supplies use two disinfectants: UV light for protozoa and chlorine for bacteria/viruses.

The most appropriate disinfectant for a water supply, and the accompanying treatment processes that are required, eventually have to be judged on a case-by-case basis. As a general guide, consideration should be given to the following:

- the need to augment the disinfection process with physical treatment or chemical coagulation to aid the removal of disinfectant-resistant organisms, and to reduce the levels of suspended particulate matter which may shield micro-organisms from disinfecting agents
- failing that, the ability of the disinfectant to satisfactorily inactivate pathogens known (or likely) to be present in the source water within the restrictions of acceptable disinfectant residual and available contact time

- the need to treat the water with chemical coagulation and subsequent filtration to reduce the levels of colloidal and dissolved matter that absorb or consume the disinfectant
- the need to treat the water to remove precursors from which disinfection by-products might be formed
- the impact of the disinfectant on the concentration of organic nutrients in the water, that might encourage regrowth in the distribution system
- the use of two oxidants: one to improve disinfection, or minimise disinfection by-product formation, and the second to provide the disinfecting residual
- the susceptibility of the distribution system to external contamination, and its impact on the importance of a disinfectant residual
- the availability of reliable supplies of electricity and any chemicals or other consumables required
- the ease and accuracy with which disinfectant residuals can be measured
- the use of the oxidising power of the disinfectant for the control of iron, manganese, and tastes and odours
- the operational and capital costs of the planned disinfection system
- whether the technology is appropriate for the water supply concerned
- the needs, wants and concerns of the community.

A summary of the characteristics of the predominant disinfection techniques is provided in Table 15.3.

**Table 15.3: Characteristics of different disinfectants**

|  | Chlorine           | Chloramination | Ozone        | Chlorine dioxide | UV light                     |
|--|--------------------|----------------|--------------|------------------|------------------------------|
| Size of plant                          | All sizes          | All sizes      | All sizes    | All sizes        | All sizes                    |
| Equipment reliability                  | Good               | Good           | Fair to good | Fair to good     | Fair to good                 |
| Relative complexity of technology      | Simple to moderate | Moderate       | Moderate     | Moderate         | Simple to moderate           |
| Safety concerns                        | Yes                | Yes            | Moderate     | Yes              | Minimal                      |
| Bactericidal                           | Good               | Good           | Good         | Good             | Good                         |
| Virucidal *                            | Moderate           | Poor           | Good         | Good             | Slight/moderate              |
| <i>Giardia</i>                         | Moderate           | Poor           | Good         | Good             | Good                         |
| <i>Cryptosporidium</i>                 | Nil                | Nil            | Good         | Moderate         | Good                         |
| By-products of possible health concern | Yes                | A few          | Yes          | Yes              | Nil? Significance unresolved |
| Persistent residual                    | Moderate           | Long           | None         | Long             | None                         |
| Contact time needed                    | Moderate           | Long           | Short        | Moderate         | Short                        |
| pH dependent                           | Yes                | Moderate       | Slight       | Slight           | No                           |
| Process control                        | Well developed     | Well developed | Developing   | Developing       | Developing                   |
| Capital costs                          | Low                | Moderate       | High         | Moderate         | Moderate                     |
| Operating costs                        | Low                | Moderate       | High         | High             | Moderate                     |
| Used in New Zealand                    | Extensively        | No             | Some         | No               | Quite common                 |

\* See Chapter 7 for further discussion about viruses. Some types of virus, mainly the adenoviruses, are more resistant to disinfection processes, particularly UV.

## 15.4 Disinfection by-product formation

### 15.4.1 Introduction

Trihalomethanes were first discovered in chlorinated drinking waters in the mid-1970s (Rook 1974, Bellar et al 1974). Since then, the practice of prechlorination (dosing chlorine into the raw water) has largely been replaced with post-treatment chlorination which has greatly reduced the production of disinfection by-products (DBPs). Also, alternative disinfectants have been used to reduce the concentrations of DBPs in treated waters.

Two things have become apparent since the first discoveries. Firstly, closer examination of chlorinated waters has shown that trihalomethanes are only one of a large number of types of disinfection by-products that can be formed. Secondly, the use of an alternative disinfectant may relieve the problem of trihalomethane formation, but for all disinfectants, except ultraviolet irradiation (research on this is yet to be completed), other undesirable disinfection by-products can be produced.

New Zealand's foremost concern, like other countries, is to provide microbiologically safe water. **The microbiological quality of the water must never be sacrificed just to minimise disinfection by-product formation.** This is not to say that efforts should not be made to keep disinfection by-product concentrations to a minimum.

Chemical and compliance issues are discussed in Chapter 10: Chemical Compliance, sections 10.2, 10.6 and 10.7. DBPs with MAVs include the trihalomethanes (THMs), haloacetic acids (HAAs) and haloacetonitriles (HANs).

## 15.4.2 Formation

This section provides a brief overview of the factors affecting disinfection by-product formation, and consequently what steps a water supplier might take to reduce the formation of disinfection by-products in their supply. Factors affecting the formation of the less significant (in terms of their concentration) disinfection by-products have yet to be fully studied. Section 15.4.5 lists the DBPs found to date.

Disinfection processes using chlorine and ozone tend to produce the most DBPs due to their high reactivity. Chloramines and chlorine dioxide produce fewer THMs so have had less reason for study. Chlorinated species usually dominate over brominated species, except in (rare) waters with a high bromide concentration.

The order of dominance is generally THMs>HAAs>HANs. Organic chloramines (N-chloramines) are formed when chlorine reacts with amines, amino acids, proteinaceous material and other forms of organic nitrogen involving amino groups or linkages. The general reaction of amino acids with chlorine in aqueous solution has been known for many years, and reviews have been published (for example, Glaze et al 1982). Amino acids of the type  $R-CH_2-CH(COOH)NH_2$  react readily with chlorine and initially form monochloramines ( $R-CH_2-CH(COOH)NHCl$ ) and, depending on the conditions, dichloramines ( $R-CH_2-CH(COOH)NCl_2$ ). Further reaction leads to nitriles ( $R-CH_2CN$ ) and/or aldehydes ( $R-CH_2CHO$ ). Organic chloramines are usually formed at slower rates than inorganic chloramines and are not considered to be effective disinfectants. While some organic chloramines are stable, others are not and degrade to many other by-products. Typically, high quality groundwater contains up to 1 mg/L (as organic carbon), river water contains 1 to 10 mg/L, while upland water may contain up to 20 mg/L (as organic carbon) which is almost entirely of natural origin (from humic substances) (IARC Monograph 52).

Factors affecting disinfection by-product formation include:

- the disinfectant, its dose, mixing efficacy and residual concentration
- impurities in the disinfectant
- natural organic matter (NOM) in the water being dosed (ie, precursors)
- other organic matter components (ie, precursors)
- pH of the water
- time that the disinfectant is in contact with the organic matter
- water temperature

- bromide ion concentration in the water, and to a lesser extent, iodide
- quality of the salt used for making chlorine, especially its bromide content
- age of hypochlorite solutions: see chlorate and perchlorate datasheets
- nitrite, or organic nitrogen concentration (applicable to chloropicrin formation)
- cleanliness of the distribution system.

These factors depend on both the water quality and the treatment process, hence variation in either water quality or treatment will create changes in disinfection by-product levels; these can vary seasonally as well. Health Canada (1995) found total trihalomethanes (TTHMs) and haloacetic acids (HAAs) were the major DBPs found in all facilities for all treatment processes and HAA levels often equalled or exceeded TTHM concentrations. Mean and median TTHM levels were higher in the summer than the winter and increased in the distribution system except for chlorine-chloramine treatment.

Generally, chloroform and bromodichloromethane are the most common THMs. There are up to nine chlorinated/brominated haloacetic acids, the main two being dichloroacetic acid and trichloroacetic acid; see datasheets.

An indication of the natural organic matter content can be gained by measuring the absorbance of the water at 254 nm in a silica cell. NOM matter contains compounds which disinfectants are able to react with to form disinfection by-products; the higher the organic matter concentration the greater the potential for disinfection by-product production. The major components of organic matter in water are humic and fulvic acids produced from the decay of vegetation. The concentration of organic matter in water may change markedly, and very rapidly, as the result of a rain event and even to the intensity of the rain, or more slowly on a seasonal basis. Most of the humic and fulvic acids that react with disinfectants to form disinfection by-products are small molecules, often with a molecular weight of less than 1,000. A lot of these are dissolved rather than colloidal, so are not removed to any significant degree by chemical coagulation. Despite this, chemical coagulation can achieve reductions in the formation of by-products well in excess of 50 percent (Reckhow and Singer 1990). The level of reduction depends on the chemical composition of the organic matter. Activated carbon should be more effective in removing low molecular weight humic substances.

Disinfectants can also react with chemicals not removed from the raw water, eg, with phenols, and with chemicals leached from plumbing and associated fittings, usually when made from plastics.

Unless groundwaters are in contact with buried organic matter, they generally contain low levels of organic matter due to the microbiological degradation and adsorption of organics, as the water percolates through subsurface strata.

Seasonal changes in water temperature can also cause changes in the concentrations of disinfection by-products formed. Chemical reaction rates increase with increasing temperature, hence, all other reaction conditions being the same, more disinfection by-products will be produced in warm water than cold water.

Disinfection by-product concentrations increase with increasing disinfectant concentration. The best-characterised relationship is between THM production and chlorine dose. There is a moderately steep increase in THM production as the chlorine dose is increased, until sufficient chlorine has been added to meet the full chlorine demand of the water. At doses beyond this value there is little increase in THM concentration as the chlorine concentration is increased.

The influence of pH on the concentration of disinfection by-products depends upon the category of disinfection by-product in question. Within the pH range of typical drinking-water, increasing the pH (up to pH 9.5) increases the concentrations of THMs, whereas the concentrations of trihaloacetic acids increase as the pH is decreased (maximum dichloroacetic acid production occurs at pH 7.0–7.5).

The production of disinfection by-products from organic matter is not instantaneous. The production of THMs, for example, may continue for weeks, although, at typical pH and temperature values, greater than 80 percent of the final concentration may be formed within 48 hours. Concentrations of trihalomethanes in a distribution system are therefore expected to be greater than the concentrations in the water leaving the treatment plant. The holding times in service reservoirs before the drinking-water enters the distribution system will have an influence on the disinfection by-product concentrations in the reticulated water; the longer the holding time in the reservoir, the higher the disinfection by-product concentrations entering the distribution system. However, it has been observed that haloacetic acids tend to exhibit higher concentrations near the treatment plant.

In light of the above discussion, it is not surprising that the concentrations of DBPs can vary considerably, even over a short time; Rizak in CRC (2002) noted one study that showed THM concentrations in samples collected every four hours from a continually running tap fluctuated as much as 44 percent.

Because there is no online monitoring tool that can be used to monitor for DBP formation potential reliably WRF (2016a) evaluated the effectiveness of new on-line monitoring tools and response systems that can be used to detect subtle changes in the character and amount of NOM and its effect on disinfection by-product (DBP) formation potential. They evaluated:

- advanced online instrumentation technology (eg, scan units) based on UV spectral derivatives
- specific excitation/emission matrix (EEM) pairings from the 3-D fluorescence monitoring
- the output of the online units with NOM properties discerned from characterisation methods including fractionation techniques based on NOM polarity, as well as examination of spectral properties, including generating 3-D fluorescence spectra and analysing absorbance spectral slopes.

Some techniques correlated moderately well for both THMs and HAAs.

## Brominated disinfection by-products

Brominated species form when using ozone due to free radical reactions; ozone's very high reactivity can rupture organic molecules, forming aldehydes, organic acids and ketones, not necessarily halogenated. Chlorine oxidises bromide to hypobromous acid (as below) which, like hypochlorous acid, is reactive:

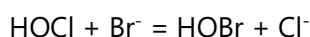

The presence of bromide in water can affect the concentrations of disinfection by-products and the types of disinfection by-products formed. A lot of the bromide in New Zealand waters is from aerosols blown inland from the sea; it also occurs in geothermal and hydrothermal waters. Chlorine and ozone are both able to oxidise bromide to bromine (or hypobromous acid or hypobromite ion depending on the pH of the water), and ozone can further oxidise the hypobromite ion to bromate. About half the bromide is oxidised to bromate by ozone. When bromine or its compounds are present in the water, bromination reactions similar to the chlorination reactions that produce the chlorinated organic disinfection by-products may occur. These reactions produce disinfection by-products containing bromine at the expense of those disinfection by-products containing only chlorine. The reactions resulting in the incorporation of bromine into organic matter are faster than those incorporating chlorine. As a result, quite low bromide levels in the raw water can lead to a significant fraction of the total disinfection by-products formed containing bromine. The presence of bromide therefore changes the relative concentrations of the different by-products. Without high bromide levels, chlorinated species dominate (eg, chloroform, trichloroacetaldehyde, tetrachloropropanone, dichloroacetonitrile, trichloronitromethane); with elevated bromide levels (eg, 1 mg/L), these shift to brominated species (eg, bromoform, tribromoacetaldehyde, tetrabromopropanone, dibromoacetonitrile, tribromonitromethane). Bromide concentrations are generally low in New Zealand.

## Iodinated disinfection by-products

The occasional detection of iodinated halomethanes is probably due to a similar mechanism involving iodides, which usually appear in drinking-water at even lower concentrations than bromide. DWI (2016) reports that during a US occurrence study the most iodine-containing THMs were found at a plant that treated a water source high in bromide (iodide was not measured) that used chloramines only or, on one occasion, used chlorine dioxide as a pre-oxidant. Plants that used chlorine only or ozone and chlorine typically produced some of the lowest levels of iodine-containing THMs.

DWI (2016) identified high risk sites for iodinated DBP formation in England and Wales. Iodide levels in boreholes in England and Wales from 2008 showed median values ranging from 1.0–15.1 µg/L. There was no single factor identified that contributes to high iodinated DBP formation but rather a combination of factors. These are listed below. Factors that contribute to higher iodinated DBP formation:



- high iodide concentration in raw water
- a shorter free chlorine contact time
- gentle pre-oxidation step in the water treatment process (eg, permanganate)
- lack of strong oxidation step in the water treatment process (eg, ozone)
- low bromide levels relative to iodide (low bromide:iodide ratio).

### 15.4.3 Toxicity

The UK Water Research Foundation (2009) analysed 66 USEPA priority drinking water disinfection by-products (DBPs) for their chronic cytotoxicity and acute genotoxicity in mammalian cells, and ranked the cytotoxicity and genotoxicity of the DBPs. They noted that the majority of DBPs have yet to be chemically characterised, and only a small fraction of DBPs have been evaluated for their biological and toxicological effects.

Some of their findings were:

- diiodoacetamide was the most cytotoxic agent and bromodichloromethane was the least cytotoxic
- the rank order from most cytotoxic to least cytotoxic for the DBP classes was haloacetaldehydes > haloacetamides > halonitromethanes > haloacetonitriles > > 2C-haloacids > haloacetic acids > halomethanes
- a majority (75.8 percent) induced significant levels of genomic DNA damage. In this group, iodoacetic acid was the most genotoxic. The least genotoxic was chlorodibromoacetic acid
- for induced genomic DNA damage, the rank order from the most genotoxic to the least genotoxic of the DBP classes was haloacetonitriles > haloacetamides > halonitromethanes > haloacetaldehydes > haloacetic acids > >2C-haloacids > halomethanes
- iodinated DBPs were more cytotoxic and genotoxic than their brominated and chlorinated analogues; note that iodinated DBPs are also usually the most rare
- in general, nitrogen-containing DBPs were more toxic than DBPs that did not contain nitrogen.

### 15.4.4 Occurrence

The USEPA has regulated two groups of organic DBPs, the trihalomethanes (THMs) and the haloacetic acids (HAAs). These two groups only represent a fraction of the DBPs formed in municipal drinking water systems, so there is interest in identifying and controlling exposure to non-regulated DBPs that may be deemed to be hazardous. To gather data a project in the US involved 13 sampling campaigns from 11 WTPs between January 2011 and June 2012. Samples were collected from about a dozen sites representing finished water; water with low, medium, and high water ages; and water from sites typically associated with nitrification or low chlorine residuals. Results indicated that concentrations of most unregulated DBPs were highly variable between different utilities and even across some service areas within a single system. There were no reliable or universal relationships between the regulated THMs and HAAs and the

non-regulated compounds. However, there were patterns that could be identified based on residual disinfectant type, pH, and treatment, especially the use of strong oxidants and long free chlorine contact times for systems using chloramines. Most water systems have bacteria with dehalogenase genes that are capable of biodegrading a wide range of DBPs. Proliferation of these organisms to the point that they actually depress DBP levels in the system is less common and seems to be related to areas prone to nitrification. Many non-regulated DBPs are subject to alkaline hydrolysis and abiotic degradation. Stability of these compounds in actual distribution systems is often greater than expected from simple laboratory experiments, suggesting protective mechanisms may be at play (WRF 2016c).

### 15.4.5 Booster chlorination

Typically, chemical disinfectants are added to treated drinking water at the treatment plant and is sufficient to maintain a residual up to the consumers' taps. However, where the distribution system is lengthy, it may be necessary to add or boost the disinfectant concentration in the network to maintain a residual throughout. DEFRA (2017) commissioned a study on the formation of DBPs during booster chlorination in the UK. The literature review found:

- THM concentration increases when more chlorine is added during booster chlorination
- the rate of chlorine decay and corresponding THM formation can be modelled using a second order decay model
- the concentration of free chlorine residual present in the water is not related to the level of THMs formed when free chlorine levels are less than 1 mg/L
- HAA concentration can increase or decrease or stay the same after booster chlorination
- HAA behaviour depends on the concentration of free chlorine residual in the water
- HAAs can be degraded if the chlorine residual is low and the correct type of bacteria are present in the water.

When considering all of the data collected over the study period, the increase in THMs after booster chlorination was statistically significant at the 95 percent confidence level when comparing the means; the increase was just over 10 percent. The change in HAAs after booster chlorination was not significant at the 95 percent confidence level.

### 15.4.6 DBPs found to date

Because chlorine is used extensively around the world, most studies have been directed towards chlorinated by-products.

UV light can convert nitrate to nitrite but this is only significant if both the UV dose and the nitrate content are high; also it has also been reported that aldehydes may be able to form. Reckhow et al (2010) report results of a study where chlorination followed UV disinfection. UV treatment of two sets of waters did not substantially change the tendency to form trihalomethanes, haloacetic acids, or total organic halogen under the conditions of these tests. Evidence was found of small reductions in the formation of these DBPs, but the decreases did not exceed 10%. Formation of chloropicrin and 1,1,1-trichloropropanone increased as a result of medium-pressure UV treatment but remained at levels well below those of the regulated DBPs. Low-pressure UV did not cause any detectable increase in chloropicrin formation.

Ozone can directly or indirectly react with bromide to form brominated ozone DBPs, including bromate ion ( $\text{BrO}_3^-$ ). In the presence of NOM, non-halogenated organic DBPs, such as aldehydes, ketoacids and carboxylic acids, are formed during ozonation, with aldehydes (eg, formaldehyde) being dominant. If both NOM and bromide are present, ozonation forms hypobromous acid, which, in turn, leads to the formation of brominated organohalogen compounds (eg, bromoform).

The major chlorine dioxide DBPs include chlorite ( $\text{ClO}_2^-$ ) and chlorate ions ( $\text{ClO}_3^-$ ), with no direct formation of organohalogen DBPs. Unlike the other disinfectants, the major chlorine dioxide DBPs are derived from decomposition of the disinfectant as opposed to reaction with precursors.

Use of chloramine as a secondary disinfectant generally leads to the formation of cyanogen chloride (CNCl), a nitrogenous compound, and significantly reduced levels of chlorine DBPs.

Table 15.4 summarises some individuals and groups of DBPs or impurities that have been observed; the degree of significance often depends on the composition of the raw water and treatment conditions – see individual datasheets.

Modern analytical instrumentation allows researchers to detect extremely low levels of an enormous range of chemicals, and when the concentration is higher in the treated water than in the raw water, these chemicals are often called disinfection by-products. It has almost become a competition to see who can 'discover' new DBPs; some of the newer DBPs have been called 'emerging DBPs'. Following Table 15.4 is an extensive listing; some of these chemicals have a datasheet. Concentrations are frequently no more than a few nanograms/L, and the effects at these levels are usually unknown or surmised.

**Table 15.4: Disinfection by-products often present in disinfected waters**

| Disinfectant                    | Significant organohalogen products  | Significant inorganic products  | Significant non-organohalogen products                                     |
|---------------------------------|---|---|--|
| Chlorine, and hypochlorous acid | chloral hydrate<br>chloroacetones<br>chlorophenols<br>chloropicrin<br>haloacetic acids (HAAs)<br>haloacetonitriles (HANs)<br>halofuranones (includingMX)<br>halogenated aromatics<br>halogenated hydrocarbons<br>halohydrins<br>N-chloramines<br>trihalomethanes (THMs) | chlorate (mostly from hypochlorite use)<br>dichloramine<br>monochloramine<br>perchlorate<br>trichloramine | aldehydes<br>cyanoalkanoic acids<br>nitrosamines                           |
| chlorine dioxide                |   | chlorite<br>chlorate  | unknown  |
| chloramine                      | chloral hydrate<br>chloramino acids<br>chloroacetones<br>cyanogen chloride<br>haloacetonitriles<br>N-chloramines  | chlorate<br>dichloramine<br>hydrazine<br>nitrite, nitrate<br>trichloramine                                | aldehydes<br>ketones<br>nitrosamines                                       |
| ozone                           | bromoform<br>cyanogen bromide<br>dibromoacetonitrile<br>dibromoacetone<br>haloacetic acids<br>halohydrins   | bromate<br>chlorate<br>epoxides<br>hydrogen peroxide<br>hypobromous acid<br>iodate<br>ozonates            | aldehydes<br>carboxylic acids<br>glyoxalic acid<br>ketones<br>pyruvic acid |

The following is a list of DBPs and CAS numbers that are not routinely monitored (Simmons et al 2002):

- 3,3-dichloropropenoic acid (3,3-dichloroacrylic acid)
- bromoacetonitrile [590-17-0]
- chloroacetonitrile [107-14-2]
- tribromoacetonitrile [75519-19-6]
- bromodichloroacetonitrile [60523-73-1]
- dibromochloroacetonitrile [144772-39-4]
- chloropropanone (chloroacetone) [78-95-5]
- 1,3-dichloropropanone (1,3-dichloroacetone) [534-07-6]
- 1,1- dibromopropanone (1,1-dibromoacetone)
- 1,1,3-trichloropropanone (1,1,3-trichloroacetone) [921-03-9]
- 1-bromo-1,1-dichloropropanone (1-bromo-1,1-dichloroacetone)
- 1,1,1,3-tetrachloropropanone (1,1,1,3-tetrachloroacetone) [16995-35-0]
- 1,1,3,3-tetrachloropropanone (1,1,3,3-tetrachloroacetone) [632-21-3]
- 1,1,3,3-tetrabromopropanone (1,1,3,3-tetrabromoacetone)

- 1,1,1,3,3-pentachloropropanone (pentachloroacetone)
- hexachloropropanone (hexachloroacetone) [116-16-5]
- dimethylglyoxal (2,3-butanedione)
- chloroacetaldehyde [107-20-0]
- dichloroacetaldehyde [70-02-7]
- bromochloroacetaldehyde
- tribromoacetaldehyde [115-17-3]
- 3-chloro-4-(bromochloromethyl)-5-hydroxy-2(5H)-furanone (BMX-1)
- 3-chloro-4-(dibromomethyl)-5-hydroxy-2(5H)-furanone (BMX-2)
- 3-bromo-4-(dibromomethyl)-5-hydroxy-2(5H)-furanone (BMX-3)
- (E)-2-chloro-3-(bromochloromethyl)-4-oxobutenoic acid (BEMX-1)
- (E)-2-chloro-3-(dibromomethyl)-4-oxobutenoic acid (BEMX-2)
- (E)-2-bromo-3-(dibromomethyl)-4-oxobutenoic acid (BEMX-3)
- 3-chloro-4-(dichloromethyl)-5-hydroxy-2(5H)-furanone (MX)
- 3-chloro-4-(dichloromethyl)-2-(5H)-furanone (red-MX)
- (E)-2-chloro-3-(dichloromethyl)-butendioic acid (ox-MX)
- (E)-2-chloro-3-(dichloromethyl)-4-oxobutenoic acid (EMX)
- 2,3-dichloro-4-oxobutenoic acid (mucochloric acid) [87-56-9]
- chloromethane (methyl chloride) [74-87-3]
- bromomethane (methyl bromide) [74-83-9]<sup>b</sup>
- dibromomethane [74-95-3]
- bromochloromethane [74-97-5]
- bromochloroiodomethane
- dichloroiodomethane
- dibromoiodomethane
- chlorodiiodomethane
- bromodiiodomethane
- iodoform [75-47-8]
- chlorotribromomethane
- carbon tetrachloride [56-23-5]
- 1,1,1,2-tetrabromo-2-chloroethane
- bromochloromethyl acetate
- chloroacetamide [79-07-2]
- bromoacetamide [683-57-8]
- dichloroacetamide [683-72-7]
- dibromoacetamide
- trichloroacetamide [594-65-0]
- bromonitromethane [563-70-2]
- chloronitromethane
- dibromonitromethane
- bromochloronitromethane
- dichloronitromethane

- bromodichloronitromethane
- dibromochloronitromethane
- tribromonitromethane (bromopicrin)
- 2-hexenal [505-57-7]; [6728-26-3]
- 5-keto-1-hexanal
- methylethyl ketone (2-butanone) [78-93-3]
- cyanoformaldehyde
- 6-hydroxy-2-hexanone
- benzyl chloride.

Chemical Abstracts Service (CAS) numbers listed when available.

Others referred to by Hrudey in CRC (2002) include:

- 1,1-dichloropropanone
- 1,1,1-trichloropropanone
- glyoxal
- 2-hexanal
- acetaldehyde
- formaldehyde
- isobutyraldehyde
- isovaleraldehyde
- 2-methylbutyraldehyde
- phenylacetaldehyde
- glyoxylic acid
- pyruvic acid
- ketomalonic acid
- 2-tert-butylmaleic acid
- acetate
- formate
- oxalate
- trichloroanisole
- nitrosodimethylamine (NDMA).

Note: halohydrin is a traditional term for alcohols substituted by a halogen atom at a saturated carbon atom otherwise bearing only hydrogen or hydrocarbyl groups (usually used to mean  $\beta$ -halo alcohols). Example:  $\text{BrCH}_2\text{CH}_2\text{OH}$  (ethylene bromohydrin or 2-bromoethanol),  $\text{ClCH}_2\text{CH}_2\text{CH}_2\text{OH}$  trimethylene chlorohydrin or 3-chloropropan-1-ol), and  $\text{PhCH}(\text{OH})\text{CH}_2\text{Cl}$  (styrene chlorohydrin or 2-chloro-1-phenylethanol); see IUPAC (1997).

As analytical techniques improve and detection limits lower, researchers record increasing numbers of chemical determinands in water, and in disinfected water. Simmons et al (2002) stated that more than 500 DBPs had been identified. See Goslan et al (2010) and Richardson (2005) for further developments. Kimura et al (2019) developed an enhanced technique for simultaneously measuring 39 currently unregulated compounds comprising four HALs, nine HKs, 10 HAMs, six HANs, four HNMs, and six I-THMs.

## 15.4.7 Further reading

The AWWA book entitled *Formation and Control of Disinfection By-Products in Drinking Water* contains a detailed compilation of the chemistry of DBP formation in Chapter 3 (Krasner 1999).

*Disinfectants and Disinfectant By-Products*, Environmental Health Criteria 216, was published under the joint sponsorship of the United Nations Environment Programme, the International Labour Organisation and the World Health Organization, and produced within the framework of the Inter-Organization Programme for the Sound Management of Chemicals (IPCS 2000).

The USEPA (2001) produced a guidance document on the control of disinfection by-products and microbial contaminants in drinking water.

Myllycangas (2004) studied several aspects of DBP production.

Then the USEPA (2006b) produced a series of manuals aimed to help water suppliers to identify distribution system locations with high concentrations of trihalomethanes (THMs) and haloacetic acids (HAAs).

USEPA (2007a) is a guide designed for small community water systems serving fewer than 10,000 people that are required to comply with the Stage 2 Disinfectants and Disinfection Byproducts Rule (Stage 2 DBPR); it has a large section on monitoring.

*Chlorination Disinfection By-products and Risk of Congenital Anomalies in England and Wales*. DWI (2007). This large national study found little evidence for a relationship between THM concentrations in drinking water and risk of congenital anomalies.

USEPA (2010) offers guidance in controlling disinfection by-products to water suppliers that receive their water from another authority, ie, from a bulk supplier.

DEFRA (2017) includes an excellent summary of current thinking about the production, occurrence and decay of THMs and HAAs in drinking water.

## 15.5 Disinfection processes

The Hazardous Substances and New Organisms (HSNO) Act 1996 now controls some aspects relating to the use of some chemicals used in water treatment, see Chapter 2: Management of Community Supplies, section 2.4.2 for further discussion.

### 15.5.1 Chlorine

The first recorded continuous use of chlorine as a disinfectant for a water was in Belgium just after the beginning of the 20th century. It is now the most widely used disinfectant throughout the world, including New Zealand, and this widespread use has been a major factor in reducing illness and deaths due to waterborne diseases.

Chlorine is really only used to inactivate bacteria, viruses and, if the dose/time is high/long enough, *Giardia*. *Cryptosporidium* requires a stronger disinfectant. Table 15.5 includes data from WHO (2004). See Table 15.1 for some earlier data. Table 15.5 presents conservative estimates of microbial reductions based on the more resistant or persistent pathogenic members of the group.

**Table 15.5: Chlorine C.t values for 99 percent inactivation (2 logs)**

| Micro-organism         | C.t values      | Conditions      |
|------------------------|-----------------|-----------------|
| Bacteria               | 0.08 mg.min/L   | 1–2°C; pH 7     |
|                        | 3.3 mg.min/L    | 1–2°C; pH 8.5   |
| Viruses                | 12 mg.min/L     | 0–5°C; pH 7–7.5 |
|                        | 8 mg.min/L      | 10°C; pH 7–7.5  |
| <i>Giardia</i>         | 230 mg.min/L    | 0.5°C; pH 7–7.5 |
|                        | 100 mg.min/L    | 10°C; pH 7–7.5  |
| <i>Cryptosporidium</i> | Not inactivated |                 |

Ex WHO 2004.

Chlorine has a drinking-water MAV of 5 mg/L. It is highly improbable that any water supply in New Zealand will contain anything like this concentration. See the datasheets for further information.

Figure 11.3 in WHO (2004a) was taken from Jacangelo (2002). It shows a comparison of the C.t values for 2-log inactivation of a range of micro-organisms by free chlorine. *Cryptosporidium* spp are by far the most resistant. Some other fairly resistant organisms are the mycobacteria and legionellae bacteria.

#### 15.5.1.1 Chlorine chemistry

Water supplies are chlorinated using chlorine gas (Cl<sub>2</sub>) liquefied under pressure in cylinders or drums, solid commercial calcium hypochlorite ('CaOCl<sub>2</sub>' or sometimes referred to by various trade names such as HTH), or a solution of sodium hypochlorite



(NaOCl). Sodium hypochlorite can be purchased, or made onsite, electrolytically, from salt. ANSI/AWWA Standard B200-12 covers sodium chloride.

Cyanuric acid, usually added to water as sodium dichloroisocyanurate, is commonly used in swimming pools, and is also used to disinfect drinking-water, primarily in emergencies. See datasheets.

Most chlorine products are derived from salt so the main impurity will usually be bromide which is oxidised to bromine, thence bromate; sodium hypochlorite used for water treatment should be checked for bromate (AWWA Standard B300). Low grade salt tends to foul the chlorine production process, so these days, impurity levels are quite low. Mercury and carbon tetrachloride used to be impurities in liquid chlorine but these are maintained at very low levels now.

Chlorine reacts with water to form hypochlorous acid (HOCl) and hydrochloric acid, reaction (i). In the pH range typical of drinking water, the hypochlorous acid molecule (disinfecting) dissociates, reaction (ii), to form the very weak disinfectant, hypochlorite ion (OCl<sup>-</sup>).



The relative concentrations of hypochlorous acid and hypochlorite ion are controlled predominantly by the pH (and to some extent by temperature). At low pH values, almost all of the chlorine exists as hypochlorous acid, while at high pH values, only the hypochlorite ion is present. Table 15.6 provides an indication of how the hypochlorous acid molecule and hypochlorite ion concentrations change with pH.

**Table 15.6: Variation of hypochlorous acid and hypochlorite ion with pH**

| pH  | Percentage of total chlorine    |                                |
|-----|---------------------------------|--------------------------------|
|     | Percentage of hypochlorous acid | Percentage of hypochlorite ion |
| 6.0 | 96                              | 4                              |
| 7.0 | 79                              | 21                             |
| 7.5 | 55                              | 45                             |
| 8.0 | 28                              | 72                             |
| 8.5 | 11                              | 89                             |
| 9.0 | 4                               | 96                             |

Table 15.6 shows that the relative concentrations of hypochlorous acid and hypochlorite ion change rapidly over the pH range usual for treated waters. This is also plotted in Figure 17.6 in Chapter 17: Monitoring, section 17.4.1. From these it is theoretically possible to calculate FACE, the free available chlorine equivalent, which is the FAC concentration that would have the same disinfecting power as the chlorine solution would have at pH 8. An easier approach is given in Chapter 6: Bacterial Compliance, section 6.3.7, Table 6.1.

The change in the form of the chlorine is important, because the hypochlorous acid molecule is a much more potent disinfectant than the hypochlorite ion. It is therefore necessary to measure both the chlorine concentration in the water and the pH, to

determine whether the water is being disinfected properly. For water leaving the treatment plant, FACE levels are measured after a contact of at least 30 minutes (see sections 4.3, 4.3.2.1 and Figure A1.1 of DWSNZ). Because water in the distribution system has had a much longer contact time, much of it at a pH less than 8.0, FAC measurements are considered to be a satisfactory indicator of disinfecting efficacy in the distribution system.

Chlorine is chemically very reactive and is consumed by reaction with inorganic and organic contaminants in water. The amount of chlorine destroyed by these substances is known as the chlorine demand. It is also destroyed by UV light, eg, sunlight.

For chlorine to be used most effectively as a disinfectant, the water must be dosed with enough chlorine to meet the demand, and still produce a residual. This is break-point chlorination. The residual of hypochlorous acid and hypochlorite ion is termed the free available chlorine (FAC), and it is the hypochlorous acid within the FAC that provides the disinfecting power.

The absence of a FAC residual indicates the absence of a satisfactory disinfectant. It is the responsibility of the water supplier to ensure that the treatment plant is suitably equipped to maintain an adequately disinfected water. It is the operator's responsibility to ensure that the equipment is properly maintained, and a supply of chlorine is always available. Standing the gas cylinder on scales will enable the operator to assess when the cylinder is likely to run out. Some water supplies have a 'change-over' panel which automatically switches from the cylinder in use when it empties to the reserve cylinder.

The characteristics of the source water of the supply need to be taken into account when the method of chlorine dose control is being selected. Waters in which the chlorine demand and the flow through the plant are almost constant can be chlorinated adequately by manual control. Where the water quality is fairly constant, but the flow rates change, a flow proportional controller is necessary.

Waters in which both the chlorine demand and the flow rate change require an automated system, with the dosing controlled by measurement of the FAC residual in the water. If unattended, neither manual nor flow proportional controls can alter their dose rates to match changes in raw water quality.

Chlorine's reactivity should be borne in mind when a disinfectant is being selected. It is a strong oxidant, and the majority of its reactions result in the oxidation of other substances in the water. In this role it aids in the removal of iron and manganese, and the reduction of some tastes and odours by destruction of the organic compounds from which they arise.

Chlorine reacts with any ammonia in the water to form chloramines, see next section. This reaction is often a major contributor to the initial or instantaneous chlorine demand. Normally the ammonia concentration is low enough and the chlorine dose high enough for break-point chlorination to occur, ie, all the ammonia is oxidised to nitrogen. If the FACE of the water entering the distribution system is more than 0.2 mg/L, bacterial compliance has been achieved, even if there is still a trace of monochloramine present, and compliance in the distribution system can be achieved by *E. coli* monitoring. In these situations, any ammonia present should not cause any problems. Chlorine can also react with amino compounds.

Higher concentrations of ammonia are often found in groundwaters. If a bore water is secure, no disinfection is needed. If the water supplier chooses to add chlorine (or chloramines) in order to maintain a residual in the distribution system, compliance can be measured by *E. coli* monitoring and FAC monitoring (see DSWNZ section 4.4).

If the bore water is not secure, some form of disinfection 'at the treatment plant' will be needed. Bacterial compliance of water leaving the treatment plant can be achieved by any of bacterial compliance criteria 1 to 5. If compliance criterion 2 is employed (chlorination) and the groundwater contains ammonia, at least some of the FAC will be converted to chloramines. Water suppliers will need to ensure that the combined residual disinfectants remain at an effective concentration throughout the distribution system.

Ammonia removal is expensive. If a groundwater contains a high concentration of ammonia, there may be an advantage in gaining bacterial compliance using criterion 1 (*E. coli* monitoring) or criterion 5 (UV disinfection). If maintaining a disinfecting residual in the distribution system is desired, chlorinating to form monochloramine should be satisfactory, but *E. coli* will need to be monitored.

Fairly large natural organic molecules, such as humic and fulvic acids, are usually present in surface waters, and may contribute to the chlorine demand. The oxidation of these compounds by chlorine (often slowly and therefore in the distribution system) can lead to their partial disintegration and the production of compounds which micro-organisms are able to use as a food source. The presence or production of these compounds in water entering distribution systems can enhance the regrowth of micro-organisms, particularly if there is little or no FAC.

Reactions that result in chlorine being incorporated into other compounds can also occur during chlorine's reactions, and these products may be undesirable. They can lead to chlorinated organic compounds that may be carcinogenic, and substances that can cause tastes and odours. Chlorine is also able to oxidise bromide to hypobromous acid and hypobromite, which, like their chlorine counterparts, hypochlorous acid and hypochlorite, will incorporate bromine into organic substances. The presence of bromide in waters undergoing chlorination is the source of disinfection by-products containing bromine and mixtures of chlorine and bromine.

The storage of high concentration hypochlorite solutions (sodium and calcium hypochlorite solutions) for extended periods of time should be avoided. At high concentrations, these chlorine solutions decompose with the production of chlorate and perchlorate. Sufficient chlorate can be produced for it to be detectable in the treated water.

Dry calcium hypochlorite is a powerful oxidant and is dangerous if mishandled. It should not be allowed to come into contact with heat, combustible materials, or reducing agents, and spillages should be washed away with large amounts of water. Follow the instructions on the containers.

### 15.5.1.2 Disinfection using chlorine

The difference in the disinfecting powers of hypochlorous acid and the hypochlorite ion make accurate pH measurement and its control during chlorination very important, refer Table 15.6. Hypochlorous acid is a strong disinfectant with excellent bactericidal properties. As with other disinfectants, it is not quite so effective against viruses and considerably less so against protozoa (particularly *Cryptosporidium*), and for these reasons, a multiple barrier approach to water treatment, using physical processes, produces a much more effective means of producing a safe water than disinfection alone.

In the absence of any virological compliance criteria in DWSNZ, it is suggested that to produce a water with a negligible viral risk, a water should be chlorinated to give a FAC residual equal to or greater than 0.2 mg/L after at least 30 minutes contact time, see Chapter 7: Virological Compliance, section 7.6. The water being disinfected should have a pH equal to or less than 8, and a turbidity less than 1 NTU.

A number of factors need to be taken into account when establishing a chlorine dose rate at the treatment plant. Generally, the first and most basic requirement is to achieve a minimum of 0.2 mg/L FACE after 30 contact time. In many cases, the chlorinator is set to match this residual, and the mean dose rate can only be determined by dividing the chlorine consumed by the volume of water treated. Many water supplies will want to achieve a higher residual leaving the treatment plant than 0.2 mg/L allowing a residual to pass to the extremities of the distribution system. The desired residual leaving the plant can only be determined by trial and error, the result of many FAC tests at many parts of the distribution system.

The difference between the chlorine dose and the point where the chlorine residual is measured is called the chlorine demand (between those two points). The chlorine demand of treated water varies seasonally due to water temperature and quality, and with water demand (ie, retention time), so the set point at the treatment plant will need to be changed accordingly. An observant operator will be aware of the chlorine demand and how it varies; if it increases fairly quickly, it may be a warning of a big change in source water quality, or even a treatment problem.

Chlorination of water with sufficient contact time has been shown to be effective against *Giardia*, but at the concentrations acceptable in drinking-waters it is ineffective against *Cryptosporidium*.

Despite chlorination being a well-established practice around the world, water suppliers may still lose control of the process; for example, across England and Wales DWI recorded on average one chlorination failure per month, the majority of which lasted less than 24 hours (median six hours) (DWI 2015).

### 15.5.1.3 Chlorine measurement

Many methods for measuring chlorine have been reported, but only a few are used to any great extent on a routine basis. Iodine-based methods, amperometric methods, methods using N,N-diethyl-p-phenylenediamine (DPD) and the syringaldazine method (FACTS) are described in *Standard Methods for the Examination of Water and*

*Wastewater* (APHA 2005, 21st edition). In New Zealand, DPD-based manual methods are the most widely used, while online methods usually use amperometric methods. ANSI/AWWA C670-09 covers online chlorine analysers.

All methods suffer from drawbacks. Some of these are worsened by the chemistry of the water to be treated, hence the water chemistry, and its influence on potential difficulties with the methods should be considered when selecting a method. Typical interferences arise from methods not being specific to chlorine. As a result, erroneously high chlorine results can arise from the presence of other strong oxidising agents, and *combined available chlorine* (CAC), also known as *total chloramines*, which are the products of reactions between chlorine and organic and inorganic nitrogen compounds. The chloramines are discussed more fully in the following section. Metals, such as manganese, can also interfere with these methods.

Iodine-based methods measure all oxidising agents in the water. This, together with their relatively low sensitivity, makes them of little use in routine potable water analysis.

Amperometric methods, while being more accurate than the DPD methods, are not as simple and require greater skill to perform. Amperometric methods are, therefore, generally less suitable for manual use at treatment plants. The amperometric titration endpoint is indicated instrumentally, which is an advantage over visual endpoint determination if the analyst experiences colour blindness, or is conducting the titration in poor lighting conditions.

DPD reacts with oxidising agents to produce a pink colour. In New Zealand this colour-forming reagent is used as the basis to measure chlorine by hand-held comparator or Nessleriser (colour matching by eye), by spectrophotometer (instrumental colour measurement), or by titration with ferrous ammonium sulphate (FAS). Chloramines can increase the FAC reading if high combined chlorine concentrations are present. These methods, without modification, may therefore be unsuitable for source waters with high ammonia or organic nitrogen concentrations. Ensuring that the FAC reading is obtained rapidly after mixing the reagents will minimise the interference of combined chlorine. Alternatively, the FACTS method is tolerant of much higher concentrations of CAC; however reagent solubility can create problems with this method.

The maximum chlorine concentration that can be measured reliably by the DPD/FAS titration is 5 mg/L as Cl<sub>2</sub>. Unreliable results will be obtained with chlorine concentrations higher than this, and at high enough concentrations chlorine will bleach the pink colour. Samples must be diluted with chlorine-demand free water if high chlorine concentrations need to be measured. To distinguish between an excess of chlorine and an absence of chlorine, first add a little of the water sample to the indicator, rather than adding the indicator to the sample. A high chlorine concentration will become apparent by the pink colour developing, then fading as it is bleached. The maximum concentration using colorimetric techniques depends on the method used.

Precautions, common to all methods, need to be taken to make the measurements as accurate as possible. These include immediate analysis on-site of the chlorine after sampling, performance of the measurements away from strong light, thorough rinsing of glassware after iodide has been used for combined chlorine measurements, and care that reagent solutions are changed regularly to avoid significant decomposition.

When field methods require colorimetric interpretation, all persons who have undertaken FAC tests must undertake the calibration exercise against the referee method. The identity of the person performing each field test must be recorded. The analyst making the measurement should be familiar with both the referee and field methods and possible causes of inaccuracy. Refer also to Chapter 6. DWI (2005) discusses a procedure for analytical quality control for chlorine field tests. A good feature of their Guidance is the use of stable iodate solutions in lieu of reactive chlorine solutions.

Because of chlorine's high reactivity and its destruction by UV light, ie, sunlight, care is required in selecting the sample site for checking online instruments. The sample taken for calibration should be collected immediately upstream of the point where the water flow enters the online instrument, and needs to be tested as soon as possible thereafter. As soon as the sample has been collected, the online instrument reading should be noted, this being as close as possible to the concentration of FAC that the online instrument is reporting to be in the sample.

It is normal to conduct titrations in triplicate, averaging the results. However, formal procedures are required (document in the WSP or other appropriate manual) for dealing with a result outside the expected range; see APHA (2005) and Chapter 17 of the *Guidelines*.

As noted above, the hypochlorous acid molecule and hypochlorite ion are the forms of chlorine present in drinking waters. Although Cl<sub>2</sub> does not exist in potable waters, for historical reasons FAC, CAC and total chlorine are still expressed as mg/L as Cl<sub>2</sub>.

## 15.5.2 Chloramines

Monochloramine is really only used to inactivate bacteria. Viruses, *Giardia* and *Cryptosporidium* require a much stronger disinfectant. A C.t of 1000 mg.min/L means 1 mg/L residual after 1000 minutes (16.7 hours) of contact, or 4 mg/L after 250 minutes (note that the MAV is 3 mg/L). The lack of practical experience in NZ conditions and the relatively poor inactivation of viruses by monochloramine are the main reasons why it is not offered in the DWSNZ as a means of achieving bacterial compliance of water leaving the treatment plant, ie, there is no equivalent to bacterial compliance criterion 2. Any plants using chloramines need to satisfy bacterial compliance criterion 1. Overseas, water leaving the treatment plant that has bacterial compliance is sometimes dosed with monochloramine in order to maintain a residual in the (usually large, and sometimes dirty) distribution system. See USEPA (2007) for a list of publications on chloramine.

Table 15.7 includes data from WHO (2004). See Table 15.1 for some earlier data. The table presents conservative estimates of microbial reductions based on the more resistant or persistent pathogenic members of the group.

**Table 15.7: Monochloramine C.t values for 99 percent inactivation (2 logs)**

| Micro-organism | Contact time (C.t) | Conditions |
|----------------|--------------------|------------|
|----------------|--------------------|------------|

|                        |                 |               |
|------------------------|-----------------|---------------|
| Bacteria               | 94 mg.min/L     | 1–2°C; pH 7   |
|                        | 278 mg.min/L    | 1–2°C; pH 8.5 |
| Viruses                | 1240 mg.min/L   | 1°C; pH 6–9   |
|                        | 430 mg.min/L    | 15°C; pH 6–9  |
| <i>Giardia</i>         | 2550 mg.min/L   | 1°C; pH 6–9   |
|                        | 1000 mg.min/L   | 15°C; pH 6–9  |
| <i>Cryptosporidium</i> | Not inactivated |               |

Ex WHO 2004.

The efficiency decreases under conditions of high pH and low temperature. For example, the inactivation of *E. coli* is approximately 60 times slower at pH 9.5 and temperatures of 2 and 6°C than at pH 7 and temperatures between 20 and 25°C (stated in USEPA 1999).

Figure 11.4 in WHO (2004a) was taken from Jacangelo (2002). It shows a comparison of the C.t values for 2-log inactivation of a range of micro-organisms by chloramine. *Cryptosporidium* spp are by far the most resistant. Some other fairly resistant organisms are the mycobacteria and legionellae bacteria, *Giardia* and poliovirus.

The monochloramine MAV of 3 mg/L can be expressed as 4.14 mg/L when measured as Cl<sub>2</sub>. It is highly improbable that any water supply in New Zealand will contain anything like this concentration. See the datasheets for further information.

Chloramines are the products of reaction between nitrogen-containing compounds and chlorine. The full family of compounds includes both organic and inorganic chloramines, but members of the group of inorganic chloramines are those of greatest interest in water disinfection. At present, chloramines are not known to be used intentionally in any water supplies in New Zealand. They may have a role in the disinfection of some supplies through their inadvertent production from the reaction of chlorine with ammonia naturally present in the water.

Users of kidney dialysis equipment are the most critical group that can be impacted by the use of chloramines. Chloramines can cause methemoglobinemia and adversely affect the health of kidney dialysis patients if chloramines are not removed from the dialysate water. Chloramines can also be deadly to fish. The residuals can damage the gill tissues, enter the red blood cells, and cause an acute blood disorder. Chloramine residuals should be removed from the water prior to the water contacting any fish. As such, fish hobbyists should be notified, along with pet stores and aquarium supply establishments (USEPA 1999).

### 15.5.2.1 Chemistry

Chloramines used for disinfection are produced by the reaction of chlorine with ammonia (or ammonium ion). ANSI/AWWA B305-06 and B306-07 cover ammonia. Three chloramines can be formed from this reaction depending upon the pH of the water and the ratio of chlorine to ammonia. They are monochloramine (NH<sub>2</sub>Cl), dichloramine (NHCl<sub>2</sub>), and trichloramine or nitrogen trichloride (NCl<sub>3</sub>).

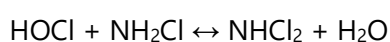

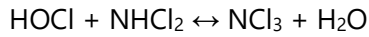

Chlorine also reacts with nitrogen containing organic compounds such as amino acids and proteinaceous matter to form organic chloramines (which have little biocidal activity), as in the following general expression:

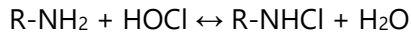

Water treatment conditions are controlled to preferentially produce monochloramine. Formation of the other two chloramines, particularly trichloramine, is undesirable because of aesthetic problems. Dichloramine can cause tastes and odours, and irritation of eyes and breathing passages can result from contact with trichloramine.

Increasing the chlorine to ammonia ratio favours the formation of the chloramines containing more chlorine, namely, dichloramine and trichloramine. Figure 15.2 (Figure 6-1 in USEPA 1999) shows why a ratio of around 4:1 is usually not exceeded in the production of monochloramine. The pH conditions that apply in Figure 15.2 are 6.5–8.5.

**Figure 15.2: The effect of chlorine to nitrogen ratios in producing chloramines compounds**

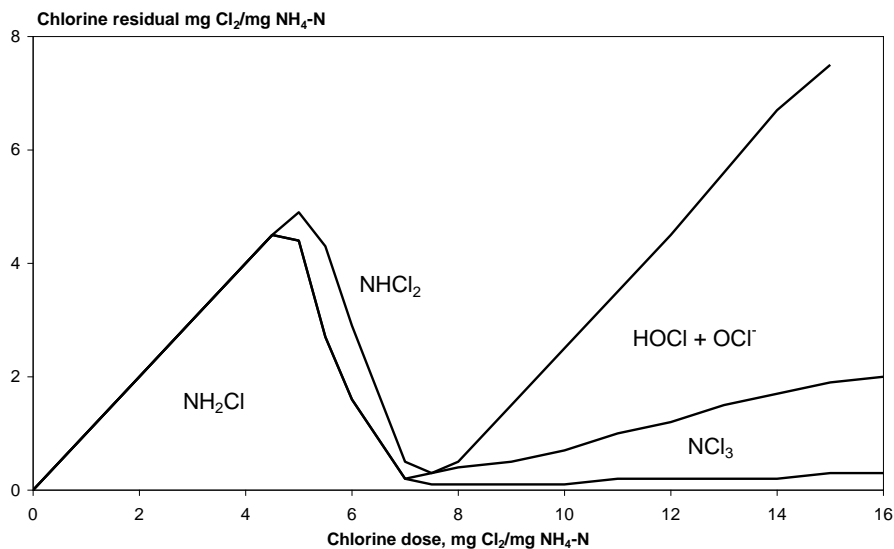

In practical disinfection conditions, it is generally considered that dosing at Cl<sub>2</sub>:N = 4:1 in the pH range 7.0–8.5 will produce a monochloramine residual with traces of dichloramine and no free chlorine. Considerable dichloramine formation can occur in poorly mixed systems. Figure 15.3 (Figure 6-2 in USEPA 1999) shows the effect of pH on chloramines production and why a low pH should be avoided, either directly or as a result of poor mixing.



**Figure 15.3: Distribution diagram for chloramine species with pH**

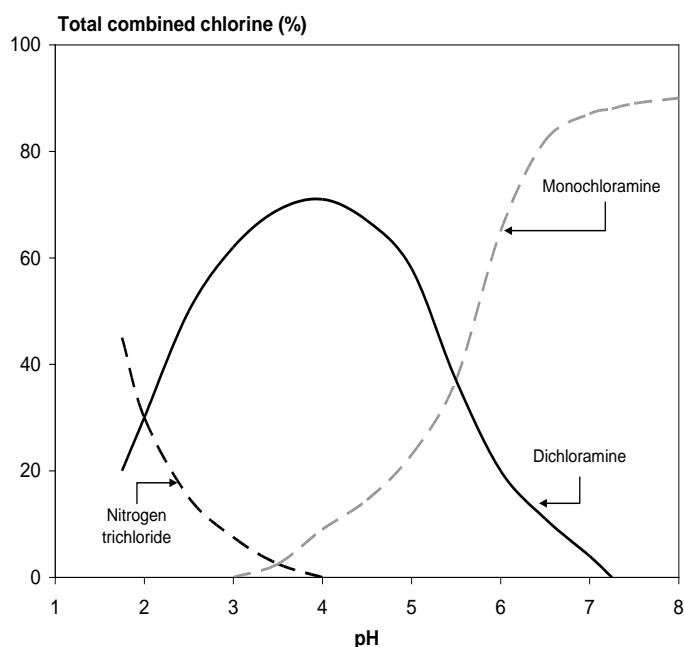

In Australia most water suppliers producing chloramine use gaseous chlorine; smaller authorities use 25 percent aqua ammonia, and bigger authorities use anhydrous ammonia. A low chlorine to ammonia ratio appears to produce fewer taste and odour problems and greater efficiency of monochloramine formation but increases the risk of nitrification due to higher levels of excess ammonia in the distribution system, where they can be oxidised to nitrite, and ultimately to nitrate (AWWA 2004). Three Australian authorities use a ratio 2:1, eight use 3:1, one uses 3.5:1, and three use 4:1. Chlorine dose rates vary from 0.7–0.9 mg/L up to 9.5 mg/L. Most authorities aim to achieve a monochloramine residual of 0.2–0.5 mg/L (as chlorine) at the extremity of the system (UWRAA 1990). Nitrification can result in increased concentrations of nitrite and nitrate, and if the ammonia content is particularly high, the nitrite MAV could be exceeded. Treatment to produce a monochloramine residual poses the risk of nitrite formation in the distribution system, especially in low-flow stagnant areas, because bacteria on surfaces and in deposits may nitrify any slight excess of ammonia (WHO 2004b).

The method by which the chloramines are generated has a bearing on the disinfection of the water and on the formation of disinfection by-products. Chlorination of the water followed by addition of ammonia offers the advantage of the disinfecting power of chlorine before it is converted into chloramines, which are much less effective disinfectants. However, it does allow the formation of the disinfection by-products associated with chlorination, albeit at lower concentrations, because of the brief contact time before ammoniation.

Adding the ammonia before chlorine also leads to some disinfection by-product formation, possibly because of competition between the ammonia and natural organic chemicals for reaction with the chlorine. The formation of disinfection by-products can be minimised by pre-forming the monochloramine offline. The rapid deactivation rate of bacteria and viruses produced by FAC is not available using either of these two approaches. If traces of phenolic substances are present, adding the ammonia first will avoid the formation of chlorophenols.

Chloramines, both inorganic and organic, can be formed unintentionally during the chlorination of waters containing ammonia, or organic nitrogen compounds that are naturally present in the water. The presence of these compounds complicates the important measurement of FAC, and may also lead to unpleasant tastes and odours. Their concentration should therefore be minimised by treatment adjustment.

Chloramines, when present as nuisance compounds, can be oxidised to nitrogen gas by chlorine and, to a small extent, to nitrate. This is achieved by ensuring that sufficient chlorine is added to the water to obtain a FAC residual. Dosing with insufficient chlorine will result in unnecessary chloramine production.

There are two reasons for the present interest in the use of chloramines for disinfection.

Firstly, it is chemically less reactive, and consequently a chloramine residual will last longer, maybe up to 20 days in the distribution system. This is an advantage in distribution systems where the maintenance of a chlorine residual is difficult because of either the extent or the condition of the network. It has been used increasingly in Australia where FAC has been unsuccessful in very long pipelines with high water temperatures, and in water that has often not undergone full treatment. In some cases chloramines have been abandoned in Australia due to biofilm problems, and when taste and odour problems could not be resolved (UWRAA 1990).

Secondly, chloramines create lower concentrations of chlorinated disinfection by-products than chlorine (except for cyanogen chloride, which is produced in higher concentrations by the chloramine process), so long as the method of generation minimises the contact between free chlorine and the water being treated (as noted above). Note however that recent studies have suggested that iodinated DBPs may be more toxic than the equivalent chloro- or bromo-BPBs. DEFRA (2009) stated:

There is evidence that the formation of iodinated DBPs is increased by chloramination and reduced by ozonation and that iodinated-THMs may be removed by GAC to some extent. Chloramination is not common in the UK, while ozonation and GAC are widely used. Taking all this information, together with modelling which estimates the formation of iodinated DBPs and limited monitoring data, it appears likely that the levels of iodinated DBPs in England and Wales will be no higher and will probably be lower than the low concentrations detected in the USA. It should be noted that the introduction of a standard for haloacetic acids in England and Wales may lead to an increased use of chloramination and if this occurred, further consideration of the concentration of iodinated DBPs in drinking water would be advisable.

Disinfection by-products are also discussed in Chapter 10: Chemical Compliance, sections 10.2.1, 10.2.2, 10.2.3, 10.2.5.3, 10.3.2 and 10.4.1, and in the individual datasheets.

### 15.5.2.2 Disinfection using monochloramine

Monochloramine is a much weaker bactericide than chlorine (dichloramine is somewhat stronger than monochloramine, and there are no data on the disinfecting

powers of trichloramine). Although dichloramine is expected to be a stronger virucide than monochloramine, some studies have shown the opposite.

Limited studies have shown that the sensitivities of a number of enteric pathogenic bacteria and the indicator organism, *E. coli*, to chloramines, are similar. Other studies have shown that some viruses are inactivated more slowly than *E. coli*. The use of *E. coli* as an indicator organism for bacteria would therefore appear to be sound, but the organism is an unreliable guide on which to judge the overall microbiological safety of a water disinfected with chloramines.

The efficacy of all disinfectants is temperature dependent, but the biocidal properties of chloramines are severely affected by low temperatures.

Because of its poorer disinfecting power, monochloramine requires longer contact times to achieve the same percentage inactivation as the equivalent concentration of chlorine. This should be kept in mind if chloramination is being considered for small distribution systems where contact times may be short. Chloramine concentrations of less than 2 mg/L as Cl<sub>2</sub> have been shown to take several hours to inactivate 99 percent of some virus species. See Table 15.7.

Nitrite can occur in the distribution system at higher concentrations when chloramination is used, but the occurrence is almost invariably sporadic. Nitrification occurs when bacteria oxidise ammonia to nitrite. Ammonia can appear in the raw water, can be produced as an end-product of the degradation of chloramine, or as an excess from chloramine production. The risk of methaemoglobinaemia therefore may become an important consideration. All water systems that practise chloramination should monitor their systems closely and regularly to verify disinfectant levels, microbiological quality and nitrite levels. If nitrification is detected (eg, reduced disinfectant residuals and increased nitrite levels), steps should be taken to modify the treatment process or water chemistry in order to maintain a safe water quality. Some trials have shown that dosing sodium chlorite as low as 0.1 mg/L can arrest the nitrification process (McGuire et al 2004). Efficient disinfection must never be compromised.

Chloramines are more toxic than chlorine to most aquatic organisms. In general, they are extremely toxic at low levels to all fish. The introduction of chloramines for disinfection may therefore create difficulties for private consumers or businesses using the reticulated water supply for keeping aquatic animals and organisms.

Chloraminated water is also unsuitable for renal dialysis patients. Removal of the chloramines from the water using activated carbon is necessary.

### 15.5.2.3 Measurement of chloramines

*Combined available chlorine*, or combined chlorine, is the chlorine present in chloramines. Any system that measures total chlorine is measuring FAC plus chloramines, see section 15.5.1.3. DPD methods can be used to measure combined chlorine, because the chlorine incorporated in these compounds can be released to develop the pink colour in the same way as chlorine. The measurement of combined chlorine is therefore a measure of the chloramines present either as a disinfectant or as

by-products of chlorination. At low combined chlorine concentrations the reaction with DPD is slow, but the speed of the colour development is increased by the addition of iodide to the reaction.

Methods using DPD have been reported for distinguishing between mono-, di- and trichloramine. These methods are prone to interference in waters containing organic nitrogen compounds, and manganese. As a result, trying to distinguish between the different inorganic chloramines in natural waters is of little value, and only combined chlorine as a total value need be reported. The monochloramine result can be falsely high if the reagents are not fresh. Refer to APHA (2005) and the datasheet for further information.

Chloramine concentrations, like the concentration of chlorine, are usually expressed in units of mg/L (as Cl<sub>2</sub>) where mg/L chloramine x 71/51.5 = mg/L as chlorine:

where:

- 71 is the molecular weight of chlorine (Cl<sub>2</sub>)
- 51.5 is the molecular weight of monochloramine (NH<sub>2</sub>Cl).

Because the success of chloramination depends on dosing two chemicals, both dosed at the correct rate and in the correct ratio, it is strongly recommended that the chloramine concentration be monitored continuously at the water treatment plant.

### 15.5.3 Chlorine dioxide

Chlorine dioxide (ClO<sub>2</sub>) was first used as a water disinfectant in the early years of the 20th century. Chlorine dioxide was used for some years in New Plymouth.

Chlorine dioxide is a stronger disinfectant than chloramines, equal or superior to chlorine on a mass-dose basis, is effective over a wider pH range, and can be used to inactivate protozoa, as well as bacteria and viruses. Unlike chlorine, it does not react (hydrolyse) with water to form a disinfectant such as or equivalent to hypochlorous acid; the gas chlorine dioxide is reasonably soluble in water, about 1000–2000 mg/L. Also unlike chlorine, it does not react with ammonia to form chloramines.

Chlorine dioxide cannot be purchased; it is made at the water treatment plant. Chlorine dioxide packs are available for travellers and for emergency use and can be purchased, for example, at sports shops.

Table 15.8 includes data from WHO (2004). See Table 15.1 for some earlier data. The table presents conservative estimates of microbial reductions based on the more resistant or persistent pathogenic members of the group.

**Table 15.8: Chlorine dioxide C.t values for 99 percent inactivation (2 logs)**

| Micro-organism | Contact time (C.t) | Conditions    |
|----------------|--------------------|---------------|
| Bacteria       | 0.13 mg.min/L      | 1–2°C; pH 7   |
|                | 0.19 mg.min/L      | 1–2°C; pH 8.5 |

|                        |              |              |
|------------------------|--------------|--------------|
| Viruses                | 8.4 mg.min/L | 1°C; pH 6–9  |
|                        | 2.8 mg.min/L | 15°C; pH 6–9 |
| <i>Giardia</i>         | 42 mg.min/L  | 1°C; pH 6–9  |
|                        | 7.3 mg.min/L | 25°C; pH 6–9 |
| <i>Cryptosporidium</i> | 40 mg.min/L  | 22°C; pH 8   |

Ex WHO 2004.

Note that the USEPA (2003a) C.t values (and as adopted by DWSNZ) for *Cryptosporidium* are much higher. The WHO value is a summary of results from laboratory studies. The USEPA C.t values have been developed for the real situation of reliably achieving x logs inactivation, within defined confidence bounds, in all types of water treatment plants, receiving a variety of raw waters. The units of concentration are as ClO<sub>2</sub>, not Cl<sub>2</sub>, see section 15.5.3.3.

Figure 11.7 in WHO (2004a) was taken from Jacangelo (2002). It shows a comparison of the C.t values for 2-log inactivation of a range of micro-organisms by chlorine dioxide. The most resistant organisms are *Cryptosporidium*, legionellae bacteria, mycobacteria, *Giardia* and calcivirus.

### 15.5.3.1 Chemistry

Chlorine dioxide (ClO<sub>2</sub>), a gas at normal temperatures, is unstable (air concentrations of 10 percent or greater are explosive) and cannot be compressed. It can be stored as a liquid for short periods below 4°C but it soon dissociates into chlorine and oxygen. For these reasons it has to be produced on-site, most frequently by the reaction of sodium chlorite and chlorine at low pH (reaction 1). The reaction of acid with sodium chlorite can be used to produce chlorine dioxide free of chlorine (reaction 2), therefore trihalomethanes will not form, but the process is less efficient for larger plants. Small plants may also add chlorite and persulphate (reaction 3). Equipment for generating chlorine dioxide is usually a proprietary product, which should be commissioned, operated, maintained and monitored according to the supplier's instructions.

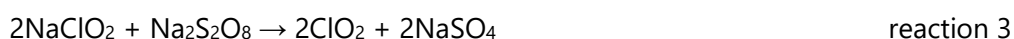
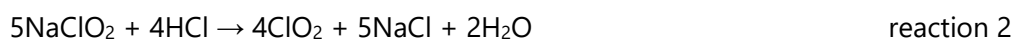

Chlorine dioxide production is somewhat dependent on reaction pH and reactor design (USEPA 1999). An excess of chlorine results from reaction 1, albeit generally less than 2 percent. Because FAC can be present with the chlorine dioxide produced by this process, the DWSNZ allow the sum of the two disinfectants to be used in bacterial compliance monitoring. However, for protozoal compliance, only the chlorine dioxide component can be reported. This requires the use of analytical techniques that can measure each disinfectant (in plants using reaction 1).

Recently, production of chlorine dioxide from sodium chlorate (NaClO<sub>3</sub>) has been introduced as a generation method where in NaClO<sub>3</sub> is reduced by a mixture of concentrated hydrogen peroxide (H<sub>2</sub>O<sub>2</sub>) and concentrated sulphuric acid. Only a few plants have been installed, all overseas.

Sodium chlorite is a powerful oxidant and, like solid hypochlorites, is dangerous if mishandled or stored incorrectly. It should not be allowed to come into contact with combustible materials, or reducing agents, and spillages should be washed away with large amounts of water. ANSI/AWWA Standard B303-10 covers sodium chlorite.

Unlike chlorine, which reacts with water, chlorine dioxide dissolves in water, but does not react with it. While it is readily soluble, it is extremely volatile and can be removed rapidly from solution by aeration. It is therefore important that systems handling chlorine dioxide are sealed to ensure that loss of the gas cannot occur throughout-gassing.

Chlorine dioxide is decomposed rapidly by sunlight and UV light, so a chlorine dioxide residual will quickly disappear from open reservoirs or sections of a treatment plant open to the sun.

Although chlorine dioxide is a compound of chlorine, it acts more as an oxidising agent than a chlorinating agent. It does not form trihalomethanes through reaction with natural organic matter, and this is one of the reasons why interest in its use has increased (apart from its ability to inactivate protozoa). However, chlorine is often used to generate chlorine dioxide, and small amounts of chlorine are usually present in the output from the generator. As a result, some formation of chlorinated organic by-products will still occur, although at much lower levels than if chlorine had been used as the disinfectant. Bromide is oxidised very slowly by chlorine dioxide, hence brominated disinfection by-products will not appear in significant concentrations when the chlorine dioxide used contains very little, or no, chlorine.

Changing to chlorine dioxide treatment to take advantage of its stronger oxidation potential can sometimes alleviate tastes that arise when chlorine is used. Oxidation by chlorine dioxide is also used to help in the oxidation of iron and manganese, although this is greatly hindered if the metals are complexed with organic matter.

The disinfection by-products of greatest concern resulting from the use of chlorine dioxide are the inorganic oxychlorine ions, chlorate and chlorite (both MAVs are 0.8 mg/L). Chlorate is an impurity formed during the generation of chlorine dioxide. Chlorite is formed from reactions with contaminants, such as natural organic matter; it may also appear as an excess of raw material. More toxicological information about chlorate and chlorite is contained in the datasheets for these compounds.

The chlorine dioxide dose is usually limited by the concentration of chlorite reaching its MAV of 0.8 mg/L. Chlorate production is less of a problem. Chlorine dioxide demand trials are needed to check the development of chlorite. USEPA (1999) reported the results of a trial dose of 1.4 mg/L chlorine dioxide. After three minutes the  $\text{ClO}_2$  concentration was 0.47 mg/L and chlorite was 0.76 mg/L. After 1 hour these were 0.11 and 1.11 mg/L respectively. Chlorate concentrations were around 0.06 mg/L throughout the trial.

Chlorine dioxide is consumed rapidly by reaction with organic matter. The use of chlorine dioxide as close to the end of the treatment process as possible reduces reaction with organic matter, and thereby minimises chlorite formation and improves the economics of treatment. Where raw waters are low in organic matter (and chlorite

formation will therefore be lower), pre-treatment with chlorine dioxide may be advantageous in the control of biological growth.

Unpleasant odours associated with the use of chlorine dioxide can arise. These appear to result from reaction between chlorine dioxide volatilising from tap water, and organic compounds in the air. The most frequently reported odours are described as being like cat urine, kerosene or new carpets.

### 15.5.3.2 Disinfection using chlorine dioxide

Bacteria are inactivated rapidly by chlorine dioxide, and it has been reported to be even more effective in inactivating viruses, although the results of different studies are conflicting. The ability to inactivate viruses appears similar to chlorine in acid and neutral conditions, but is superior at higher pH values. The effectiveness of chlorine dioxide in inactivating bacteria and viruses is generally equal, or superior, to that of chlorine on a mass-dose basis (ie, 1 mg of ClO<sub>2</sub>/L is equal to or superior to 1 mg of Cl<sub>2</sub>/L). It is a poorer disinfectant than ozone.

Chlorine dioxide is thought to inactivate micro-organisms through direct oxidation of tyrosine, methionyl, or cysteine-containing proteins, which interferes with important structural regions of metabolic enzymes or membrane proteins (taken from WHO 2004b, Chapter 3.3.3).

Cysts of *Giardia* and oocysts of *Cryptosporidium* can be inactivated by chlorine dioxide. It may be difficult to reach the required dose without exceeding the MAVs for chlorite and chlorate. It may be possible to overcome this problem by using a very long contact time in order to satisfy the C.t values for the various log removals (Table 5.5 of DWSNZ). For example:

For 3 log credits at 15°C, C.t = 536, therefore C = 536/t (in minutes), so:

for 4 hours' contact:  $C = 536/240 = 2.23 \text{ mg/L}$

for 48 hours' contact:  $C = 536/2880 = 0.19 \text{ mg/L}$ .

Note that C is the residual, not the dose; see section 15.2.9 for methods for calculating t.

To achieve the required C.t value, reliably covering periods with variations in flow, temperature or disinfectant demand, it is recommended that water suppliers establish a control limit. This should be documented in the WSP, along with actions that will prevent the situation worsening to the extent of transgressing the protozoa compliance criteria. The control limit, or margin of safety, will depend on the nature of the source water, the treatment processes, short-term flow fluctuations, and whether the contact tank has a constant volume.

There are conflicting reports about the pH dependence of the bactericidal properties of chlorine dioxide, although at low bacterial levels in natural waters the dependence appears to be slight. Inactivation of protozoa is not pH dependant.

See USEPA (1999) for a full discussion on the use of chlorine dioxide. Refer also to Chapter 10 of the review draft LT2ESWTR Toolbox Guidance Manual (USEPA 2009) which discusses issues related to the use of chlorine dioxide.

### 15.5.3.3 Chlorine dioxide measurement

During its reactions with other substances, chlorine dioxide can be converted to chlorite or chloride, depending on the pH and the substances with which it reacts. In the pH range expected in drinking-water treatment the predominant end-product is chlorite. The oxidising potential of this reaction is less than that of the reaction that converts chlorine dioxide to chloride.

These two processes by which chlorine dioxide can oxidise other substances complicate the reporting of results, and can lead to misunderstanding about the disinfecting powers of chlorine dioxide residuals. Confusion can arise in the expression of the chlorine dioxide concentration because many texts provide calculations from the raw test readings that express chlorine dioxide in mg/L as  $\text{Cl}_2$ , assuming that chlorine dioxide is fully reduced to chloride during its reactions. Expression of the concentration of chlorine dioxide in mg/L as  $\text{Cl}_2$ , and on the basis that it is converted to chloride (which it isn't), can give a false impression of the disinfecting capabilities of the chlorine dioxide residual and of the oxidising capabilities of the chlorine dioxide present in the water unless the method of measurement is clearly stated and its chemistry understood. These problems can be overcome largely by expressing the results of chlorine dioxide measurements as mg/L  $\text{ClO}_2$ . The chlorophenol red method referred to in the chlorine dioxide datasheet expresses its results directly as mg/L  $\text{ClO}_2$ . If either the APHA amperometric or DPD method referenced in the datasheet is being used for chlorine dioxide measurement, the factors provided in the method can be used to express the results in mg/L  $\text{ClO}_2$ .

The measurement of chlorine dioxide in water can be complicated, especially if chlorine and chloramines are also present, and if the concentrations of chlorite and chlorate are also required. Chloramines should not cause analytical problems if the ammonia content in the raw water is low. Iodometric, amperometric and DPD methods of measuring chlorine dioxide are documented.

The iodometric method given in *Standard Methods for the Examination of Water and Wastewater* (21st edition 2005, APHA, AWWA, WEF) can be used for measuring chlorine dioxide in pure solutions, ie, for temporary standards, but is of little value for field measurements.

The amperometric method is a modification of that used for chlorine measurement. The methods in APHA (2005) can produce results for FAC, chloramines, chlorite, chlorate and chlorine dioxide. These involve up to four separate measurements made under different test conditions, followed by a series of calculations. Requiring four measurements leads to a higher level of uncertainty.

If chlorine dioxide is produced by the acid/chlorite process, there should be no FAC or chloramines present, in which case the chlorine dioxide concentration can be measured directly; this allows continuous monitoring.

Being reactive, chlorine dioxide must be measured as soon as possible after collecting the sample. For bacterial and protozoal compliance testing, the DWSNZ require online measurement. To avoid the fairly high analytical uncertainty in the measurement of



chlorite and chlorate by the methods discussed above, they should be measured by ion chromatography for compliance purposes.

The DPD method is a modification of the chlorine method, in which any chlorine is neutralised by the addition of glycine. The chlorine dioxide measurement requires only one reading, but if chlorine is to be determined as well, the difference of two readings is required, and the determination of chlorite requires three readings.

The chlorophenol red method is reported to be a relatively simple, sensitive and specific method (no interference from chlorine, chlorite, chlorate or chloramines) for the measurement of chlorine dioxide. The chlorophenol indicator can be used as part of a colorimetric or titration method (Harp et al 1981).

A lissamine green/horseradish peroxidase spectrophotometric method was developed (USEPA 2005) for WTP monitoring.

## 15.5.4 Ozone

Note: The ozone section of the 1995 edition of the Guidelines contained only two pages, mainly because at that time, ozone was not used in New Zealand for disinfecting drinking-waters. By 2005, more detailed protozoa compliance criteria had been developed for the DWSNZ, based largely on treatment processes rather than monitoring protozoa in the water supply. The efficacy of ozone in inactivating protozoa suggests the process may be used more often in the future. Therefore this section has been expanded to 7–8 pages. Further information also appears in Chapter 8: Protozoa Compliance, section 8.4.4.2, which discusses compliance issues related to ozone, including a summary of how the USEPA derived the C.t values for 1, 2 and 3 log removals.

These Guidelines aim to provide the reader with a general understanding of the issues related to disinfection using ozone for disinfecting drinking-water in New Zealand. This section deals more with operational matters; Chapter 8 covers compliance issues. Because compliance is largely determined by assessing operational requirements (section 5.15 of the DWSNZ), inevitably there will be some overlap.

Although ozone was first used for water treatment near the turn of the century, its recent increased usage has stemmed from concerns over the disinfection by-products produced by chlorine, and due to its relative ease in inactivating protozoal (oo)cysts.

Ozone is a potent bactericide, a strong virucide and it can inactivate cysts/oocysts and spores. Cysts and spores are approximately ten times more resistant to ozone than viruses. Ozone is a more powerful disinfectant than chlorine for all classes of organism by factors ranging from 10 to 100. The germicidal efficiency changes only slightly over the pH 6.5 to 8, the range of interest in most potable waters. Table 15.9 includes data from WHO (2004). See Table 15.1 for some earlier data. The table presents conservative estimates of microbial reductions based on the more resistant or persistent pathogenic members of the group.

**Table 15.9: Ozone C.t values for 99 percent inactivation (2 logs)**

| Micro-organism         | Contact time (C.t) | Conditions   |
|------------------------|--------------------|--------------|
| Bacteria               | 0.02 mg.min/L      | 5°C; pH 6–7  |
| Viruses                | 0.9 mg.min/L       | 1°C          |
|                        | 0.3 mg.min/L       | 15°C         |
| <i>Giardia</i>         | 1.9 mg.min/L       | 1°C; pH 6–9  |
|                        | 0.63 mg.min/L      | 25°C; pH 6–9 |
| <i>Cryptosporidium</i> | 40 mg.min/L        | 1°C          |
|                        | 4.4 mg.min/L       | 22°C         |

Ex WHO 2004.

Figure 11.5 in WHO (2004a) was taken from Jacangelo (2002). It shows a comparison of the C.t values for 2-log inactivation of a range of micro-organisms by ozone. The most resistant organisms are *Cryptosporidium*, the mycobacteria and legionellae.

Table 7.7 in WHO (2017) shows the range of C.t values found for ozone for 2-log inactivation:

|          |   |
|----------|---|
| viruses  | 0.006 to 0.2 min mg/L at 0-10°C, pH 7–9 |
| bacteria | 0.02 min mg/L at 15-25°C, pH 6.5–7      |
| protozoa | 0.5 to 40 min mg/L.                     |

Ozone is used in drinking-water treatment for a variety of purposes including:

- disinfection
- oxidising inorganic compounds, including iron, manganese, and sulphide (see Chapter 18)
- oxidation of organic compounds for colour removal, increasing the biodegradability of organic compounds, reduction of disinfection by-products (DBPs) and reduction of chlorine demand
- oxidation of trace organic compounds, such as those producing taste and odour, phenolic compounds, and some pesticides.

In the majority of applications it is added as a disinfectant. Ozone is not dosed to remove a measurable, specific contaminant in the water (at least, not measurable on-site). An ozone dosing installation is operated under similar principles to that of a chlorine installation, ie, it is dosed to achieve a desired C.t after a given contact time (note that C.t is absolute hydraulic residence time, not contact time). As with chlorine, the contact time in a contactor will vary with plant flow and, consequently the rate of dosing ozone (in g/h) will vary. As with chlorine, the ozone demand can change too. The ozone dose rate is also varied to meet any change in demand. This is achieved by continuously monitoring the ozone concentration and altering the ozone dose rate to achieve the desired outlet concentration. Thus an ozone dosing installation maintains the required C.t by ensuring a minimum ozone dose is maintained through changes in flow (contact time) and ozone demand.

### 15.5.4.1 Ozone chemistry and production

Ozone, O<sub>3</sub>, is a toxic, unstable form of oxygen. It is a stronger oxidising agent than oxygen and one of the strongest of the oxidising agents used to treat water. As a result of its instability it has to be produced on-site. It is produced by the reaction between an oxygen atom and an oxygen molecule.

Ozone is produced by passing dry air, oxygen, or a mixture of the two, through two electrodes separated by a dielectric and a discharge gap. A high voltage is applied, resulting in a flow of electrons through the discharge gap. The electrons provide the energy required to dissociate the oxygen molecule, leading to the formation of ozone.

The four major components of an ozone treatment system are:

- gas feed
- ozone generator
- ozone contactor
- ozone off-gas destructor.

#### Gas feed

This is commonly high purity oxygen, air, or a mixture of the two. For a given ozone generator the rate of production is greater when oxygen is used as the feed gas.

Liquid oxygen feeds are relatively simple and consist of storage tanks, evaporators, filters and pressure regulators, required to limit the gas pressure for the ozone generators.

Air systems are reasonably complicated, as the air presented to the generator should be clean, free of contaminants and dry, with a maximum dew point of –60°C. An air preparation system consists of compressors, filters, desiccant dryers and pressure regulators. Filters are required to remove particles greater than 1 mm and oil droplets greater than 0.05 mm. Granular activated carbon filters are used to remove any hydrocarbons present in the feed gas. Moisture is removed to prevent arcing that can result in damage to the dielectrics.

#### Ozone generator

The most common ozone production method is by corona discharge. The yield of ozone varies according to voltage, the discharge gap width, frequency, and feed gas pressure. There are trade-offs in design and operating parameters. For example, as voltage is increased, the electrodes and dielectric material are more subject to failure.

The two configurations are parallel plates and concentric cylinders, with the parallel plate more commonly used in small systems. As most of the energy used in the generator is lost as heat, a cooling system is required to maintain generator efficiency. Whereas the parallel plate system can be cooled with air, the most common coolant used is water.

The most common ozone contactors are the bubble diffuser, injector and turbine mixer.

### Bubble diffuser contactors

The depth of water in the contact tank is typically 5–7 metres to achieve 85–95 percent efficiency in ozone transfer. They can be constructed in counter-current (water and ozone flowing in opposite directions), co-current (same direction) and alternating co-current/counter-current configurations. Most treatment plants use two or three chambers for ozone contact and for reaction.

Not all of the ozone is transferred to the water. The contact chambers are covered to contain the ozone gas above the water, from where it is transferred to an ozone destructor. Some designs take the off-gas from the main contactors to a contact chamber upstream to provide another ozonation stage in the process and also provide a more efficient use of the ozone generated.

WRF (2016b) reports a case study which provided full-scale evidence regarding the difference between ozone dissolution using fine bubble diffusion (FBD) versus side stream injection (SSI) with degas. The results are intended to further the understanding of design and operation of the systems by design engineers and utilities.

### Injectors

A venturi section is used to generate a negative pressure and ozone is injected under this partial vacuum. Additional contact time is required to meet the C.t requirements of the installation. This is normally provided in a plug flow reactor.

### Turbine mixer

The ozone gas is fed into a contactor and the turbine mixer is used to mix the ozone with the water. The chamber water depth can vary from about 2–4.5 m. As with injector mixers, there may not be sufficient contact time to meet C.t requirements and additional contact volume may be required.

### Off-gas destruction

As the ozone concentration in the off-gas will be much greater than the fatal concentration, the ozone has to be converted back to oxygen prior to release. These destructors can either be operated at high temperatures or use a catalyst to allow operation at lower temperatures. The off-gas is drawn through the contactor, creating a partial vacuum to reduce the risk of escape.

## 15.5.4.2 Disinfection using ozone

The rate at which organisms are inactivated by a disinfectant increases with increasing temperature, but this can adversely affect the overall efficiency of the ozonation process. This arises from a decrease in the efficiency of transfer of ozone into water as temperature increases.

Ozone is able to achieve disinfection with less contact time and at lower concentrations than chlorine, chlorine dioxide and monochloramine, but its instability and reactivity

means that it is unable to provide a disinfecting residual. Ozone is generally used as the primary disinfectant and oxidising agent, with a secondary disinfectant such as chlorine or monochloramine added downstream, to provide a residual.

Ozone in aqueous solution may react with microbes either by direct reaction with molecular ozone or by indirect reaction with the radical species formed when ozone decomposes. Ozone is known to attack unsaturated bonds, forming aldehydes, ketones or carbonyl compounds. Additionally, ozone can participate in electrophilic reactions, particularly with aromatic compounds, and in nucleophilic reactions with many of the components of the microbial cell. Carbohydrates and fatty acids react only slightly with ozone, but amino acids, proteins, protein functional groups (eg, disulphide bonds) and nucleic acids all react very quickly with it. It is likely, therefore, that microbes become inactivated through ozone acting on the cytoplasmic membrane (due to the large number of functional proteins), the protein structure of a virus capsid, or nucleic acids of micro-organisms. Free radicals formed by the decomposition of ozone are generally less effective for microbial inactivation than molecular ozone, because microbial cells contain a high concentration of bicarbonate ions that quench the free radical reaction, and many microbial cells also contain catalase, peroxidase, or superoxide dismutase to control the free radicals produced by aerobic respiration. Taken from WHO (2004b), Chapter 3.3.4.

When chlorine (or chloramine) is used as the secondary disinfectant, it should be added after the ozone residual has been reduced to zero. The reaction between ozone and chlorine/ chloramine would result in an increased chlorine/chloramine dose requirement. Further, the oxidation of chlorine can lead to the production of chlorates.

The stability of ozone decreases with increasing pH and temperature, so that at 15°C and a pH of 7.6 the lifetime of the residual is of the order of 40 minutes, but at higher temperatures it can be as low as 10–20 minutes.

The contactor should be designed to provide plug flow hydraulics. This will result in the minimum overall volume and maintain the required C.t value for the system. The volume is determined from the applied ozone dose, the disinfection C.t requirement and the estimated residual ozone concentration.

Generators should be checked daily when in operation and their maintenance requires skilled technicians. If trained maintenance staff is not available at the plant, the equipment manufacturer should do this work.

After a shutdown, dry air or oxygen should be passed through the generator to remove any moisture prior to energising the electrodes. At initial start-up and after long downtimes, this process may take up to 12 hours and usually longer when air is the feed gas. A small flow of dry air can be passed through the generator continuously when it is in standby mode to maintain the dry condition.

Filters and desiccant dryers in air preparation systems should be changed periodically, with the frequency depending on the quality of the inlet air and the number of hours in operation. Compressors require periodic service, depending on the type and operating time. Liquid oxygen tanks should be periodically pressure tested. Piping and contact chambers should be inspected periodically to check for leaks and corrosion.

## Disinfection by-product (DBP) control

The key variables that determine ozone's effect in the oxidation of DBP precursors, prior to chlorination, are dose, pH, alkalinity, and the nature of the organic material. At low pH levels, precursor destruction is quite effective; above some critical pH, ozone is less effective, and sometimes increases the amount of chlorination by-product precursors. For most humic substances the critical pH is 7.5, which is about the level at which decomposition of ozone to hydroxyl free radicals increases rapidly, thus increasing organic oxidation rates.

Higher alkalinities help reduce THM formation potential (THMFP). This is because alkalinity scavenges any hydroxyl free radicals formed during ozonation, leaving molecular ozone as the sole oxidant, which has a lower oxidation potential than the hydroxyl free radical. Given neutral pH and moderate levels of bicarbonate alkalinity, THMFP level reductions of 3–20 percent have been shown at ozone doses ranging from 0.2 to 1.6 mg ozone per mg carbon.

The formation of bromate ( $\text{BrO}_3^-$ ) as a disinfection by-product of ozone is of greater health significance than the formation of organic disinfection by-products. Bromate is formed by the oxidation of bromide in the water. Factors that lead to reduced bromate formation are: low bromide concentration, low pH, high NOM concentration, and a high ammonia concentration. This is because:

- 1 a low bromide concentration limits the amount of bromate that can form
- 2 low pH favours the formation of molecular  $\text{O}_3$  and reduces the formation of free radicals from ozone. It is the free radicals that are the primary route to bromate
- 3 high NOM acts as a sink for bromide. Bromide is initially oxidised to  $\text{BrO}^-/\text{BrOH}$ , which will react with NOM if it gets the opportunity. The higher the NOM concentration the greater the likelihood of this reaction taking place, and the less bromine there is available to go on to form bromate
- 4 ammonia provides another sink for bromide. Again, after the initial oxidation of bromide, the  $\text{BrO}^-/\text{BrOH}$  reacts rapidly with ammonia if it gets the opportunity, thereby stopping bromate formation.

Both 3 and 4 work by increasing the rate at which a process that competes with bromate formation occurs.

## By-products

Ozone can produce undesirable by-products. It can break down organic matter such as humic substances to small organic compounds that are assimilated more readily by micro-organisms. This can promote microbial regrowth in distribution systems. The increased assimilable organic carbon concentration can be reduced by filtration and by adsorption using granular activated carbon beds. This should be considered to minimise any regrowth problems that may be associated with ozone.

Ozone can oxidise any bromide present in the water to bromate. The oxidation reaction with bromide leads to the production of hypobromous acid and hypobromite. Hypobromite can be oxidised to bromate, a possible carcinogen. The hypobromous acid and hypobromite can react with organic matter present to form brominated organic compounds, similar to those formed by chlorine.

Ozone treatment is inadvisable for waters containing bromide, such as bore waters prone to seawater intrusion. One of the products of the reaction with chloride is chlorate, which has a MAV of 0.8 mg/L.

See section 15.4 and Chapter 10: Chemical Compliance, section 10.2, which also discuss DBPs. Some ozone disinfection by-products are listed in the Datasheets Index, section 3.2(a). Refer also to Chapter 11 of the review draft LT2ESWTR Toolbox Guidance Manual (USEPA 2009) which discusses issues related to the use of ozone.

### 15.5.4.3 Ozone measurement

The ozone process can be monitored, with manual control often used for small systems. Flow and ozone monitors can be used together, to match dose to water flow and ozone demand. Ozone generation can be controlled to meet these process demands.

The process is very reliable and can be highly automated, requiring only a modest degree of operator skill and time to operate an ozone system.

Instrumentation can play an important role in the safe and efficient operation of an ozone system. To maintain a safe working environment, gas phase ozone concentrations should also be measured:

- in workspaces where personnel routinely visit, such as ozone generator rooms
- on the outlet from the off-gas destructor, to ensure the destructor is achieving the correct ozone concentration in air being discharged to the environment.

These monitors should be linked to the ozone generator, shutting down in the event of raised ozone levels detected.

#### Ozone residual measurement: sampling

As the half-life of ozone in water is very short, from 1 to 40 minutes, the ozone concentration has to be measured very soon after the sample is taken. Online sampling should be designed to minimise the detention time. Separate sample ports should be provided at the outlet of each contact chamber to provide the maximum flexibility in measuring ozone in water residuals through the ozonation process. The sample pipe inlets need to be located in the main stream and be extended into the contactor chamber to ensure a representative sample is obtained. The inlet pipe requires to be designed to minimise the potential for picking up gas bubbles and also to prevent clogging, should there be solids present in the feed water. See Appendix C in the review draft LT2ESWTR Toolbox Guidance Manual (USEPA 2009).

#### Standardisation of online ozone residual monitors

Online analysers can be used to monitor continuously the ozone residual in water and provide C.t information for earning protozoa log credits, automatically. These analysers need to be standardised against grab samples on a regular basis, at least weekly. The water temperature is needed too.

USEPA (2009) states in section 11.4.1:

The concentration of ozone must be measured with the indigo colorimetric method, APHA Standard Method 4500-O<sub>3</sub> B ....

USEPA (2009) describes ozone residual measurement in Appendix C.

Checking by a Ministry of Health recognised laboratory is preferred, but if the analyser is checked using a field test method, the field test method should be calibrated against the referee method (Indigo Colorimetric Method, Standard Methods 4500-O<sub>3</sub>, APHA 2005, 21st edition) at least once every six months (DWSNZ section 5.15.3: Ozone analyser calibration) by a Ministry of Health recognised laboratory.

### Ozone residual measurement: testing (manual)

Because ozone is so reactive it is necessary to cross-check multiple samples, preferably five, using the following procedure:

- 1 Obtain an analyser reading while the grab sample is being collected, with an appropriate time delay to allow for flow time in the sample line.
- 2 Promptly measure the ozone residual concentration in the grab sample, using the indigo method.
- 3 Calculate the average grab sample ozone residual value and the average analyser ozone residual value.
- 4 Compare the average of the online and grab-sample results. The average of the online analyser should not deviate more than 10 percent or 0.05 mg/L (whichever is larger) from the grab sample average. If it is more than this, adjust the meter reading as per the manufacturer's instructions. It is important that the online analyser not record more than 10 percent or 0.05 mg/L greater than the grab samples. A negative deviation bias, while not affecting public health, may also be useful as an indication of a malfunctioning unit.
- 5 Allow the analyser to stabilise for a period of 30 minutes after adjusting the meter reading and repeat steps 1 to 4 until the difference calculated in step 4 is less than 10 percent of the grab sample average or less than 0.05 mg/L.

The indigo method assumes that high-purity reagents are used. Several reports have been published discussing a potential biasing where reported results could be significantly low. The potential biasing involves the value of the sensitivity factor used in the calculation. Water suppliers using this method should keep up-to-date with any developments.

### Process control: automatic

For automatic systems, the dose rate of ozone (usually in g/h) will be adjusted according to flow and ozone residual, possibly through computed C.t. Where ozone is dosed as a disinfectant downstream of other treatment processes, such as coagulation/clarification/filtration, the ozone demand is likely to be reasonably stable. Where there is no pre-treatment, the potential for a varying ozone demand is greater, for example, when specifying ozone on water subject to algae growth.



The process control should reflect the potential in not achieving the required C.t and, consequently, the desired log removal. This will mean operating at a slightly raised C.t to ensure that the conditions to meet the log credit undertaking are always being achieved. The operating design margin of safety is likely to vary according to the expected variations in ozone demand of the feed water, water temperature, efficacy of any upstream treatment process, short term variations in ozone generation and fluctuations in flow. This margin of safety is in effect a control limit, as required in the DWSNZ, and as such, the principles and potential follow-up actions must be documented in the WSP.

### Process control: manual

While systems under automatic control have the potential of not achieving the target C.t in a very small proportion of the daily throughput, manually controlled systems, by their nature, present a risk to a larger proportion of the daily throughput. The margin of safety allowed for in the design of ozone disinfection systems should reflect this potential risk. It may be cost-effective to install automatic control. Note that section 5.15 of the DWSNZ requires online measurement for bacterial and protozoal compliance.

## 15.5.5 Ultraviolet disinfection

Note: The UV section of the 1995 edition of the Guidelines contained only 2.5 pages, because at that time, UV was used mainly in a few small water supplies to inactivate bacteria. By 2005, more detailed protozoal compliance criteria had been developed for the DWSNZ, based largely on treatment processes rather than monitoring protozoa in the water supply. The recent acknowledgement of the efficacy of UV in inactivating protozoa suggests the process may be used more often in the future. Therefore this section has been expanded to over 10 pages. Further information also appears in Chapter 8: Protozoa Compliance, section 8.4.4.3, which discusses compliance issues related to UV, including a summary of how the USEPA derived the C.t values and operational criteria for 1, 2 and 3 log removals.

These Guidelines aim to provide the reader with a general understanding of the issues related to disinfection using ultraviolet light (UV) for disinfecting drinking-water in New Zealand. This section deals more with operational matters; Chapter 8 covers compliance issues. Because compliance is largely determined by assessing operational requirements (section 5.16 of the DWSNZ), inevitably there will be some overlap. A lot of excellent material appears in the *Ultraviolet Disinfection Guidance Manual for the Final Long Term 2 Enhanced Surface Water Treatment Rule* (USEPA 2006a). Note that in the UK, water suppliers are also recommended to use this USEPA publication (DWI 2010, 2016b). Refer also to Chapter 13 of the review draft LT2ESWTR Toolbox Guidance Manual (USEPA 2009) which discusses issues related to UV disinfection. ANSI/AWWA F110-12 is a Standard for Ultraviolet Disinfection Systems for Drinking Water. WRF (2015) reports on MP UV research since the 2006 UVDGM. The findings are likely to be incorporated into validation procedures. WRF (2016) reports possible improvements in the validation process by using Lagrangian actinometry using dyed microspheres.

UV light has been used for disinfection of drinking-water for many decades and large installations now exist or are underway in Europe and the United States. In New Zealand several of the largest water suppliers have committed to the installation of UV disinfection equipment in their water treatment plants (WTP).

Over the years the terminology and units have changed, not always similarly in Europe and the US. The International Ultraviolet Association has attempted to standardise these (Bolton 2000 and 2004).

There has been a recent growth in interest in UV disinfection. This interest has been driven by concerns related to disinfection by-products of chlorination processes, the resistance of certain protozoa such as *Cryptosporidium* to chlorine, and the identification that relatively low doses of UV can stop *Cryptosporidium* from being infective; at much lower doses than those required to kill the organisms.

While it is true that none of the disinfection by-products discussed in section 15.4 appear during ultraviolet disinfection, sunlight is known to degrade large humic molecules. Work has still to be done to characterise the effect of ultraviolet treatment on natural organic matter in water, and its health implications. DWI (2015a) reviewed the literature on the effects of UV disinfection on the chemical composition of water. They concluded that the potential formation of DBPs as a result of treatment by appropriately designed and maintained UV systems is low. The most significant DBPs are nitrite, and bromate formed from prechlorinated supplies containing bromide; the formation of both can be minimised by appropriate water treatment and UV system design. Nitrite is formed by reduction of nitrate at a wavelength of less than 230 nm. The formation of nitrite by MP lamps is minimised by the incorporation of quartz sleeves to remove the lower wavelength UV. Similarly, absorption of UV by natural organic compounds in water may also occur at lower wavelength, and any changes to water chemistry from this mechanism may influence DBP formation. No significant cytotoxicity or genotoxicity was observed with samples of raw reservoir surface water treated with UV at doses of 23 to 138 J/cm<sup>2</sup>. When UV at doses typically used for disinfection is followed by chlorination, the formation of:

- THMs and HAAs is unlikely to be affected but potentially may increase by c. 10 percent (LP or MP)
- aldehydes, carboxylic acids, TCP or HANs is unlikely to be affected
- chloropicrin and bromopicrin is likely to increase. The formation of both is promoted by higher concentration of nitrate, while the formation of bromopicrin is promoted by higher concentration of bromide
- cyanogen chloride is likely to increase
- chloral hydrate and halonitromethanes is likely to increase, at the single µg/L level (LP UV) or µg/L level (MP UV)
- nitrosamines is likely to be reduced.

When chlorination is followed by UV at doses typically used for disinfection:

- there is potential for bromate formation if bromide is present
- the chlorine decay rate may increase but this effect is unlikely to be of practical significance.

The use of UV for inactivation of protozoa has been recognised in the DWSNZ, where up to 3.0 log inactivation credits (99.9 percent reduction in infectivity) are allowed for protozoal compliance by using UV technology. This is consistent with the approach of the LT2ESWTR (USEPA 2003a and 2006).

The Ultraviolet Disinfection Guidance Manual for the Final Long Term 2 Enhanced Surface Water Treatment Rule, USEPA (2006) states:

Many microorganisms have enzyme systems that repair damage caused by UV light. Repair mechanisms are classified as either photo repair or dark repair. Microbial repair can increase the UV dose needed to achieve a given degree of inactivation of a pathogen, but the process does not prevent inactivation.

Even though microbial repair can occur, neither photo repair nor dark repair is anticipated to affect the performance of drinking-water UV disinfection, as described below:

- photo repair of UV irradiated bacteria can be prevented by keeping the UV disinfected water in the dark for at least two hours before exposure to room light or sunlight. Treated water typically remains in the dark in the piping, reservoirs, and distribution system after UV disinfection. Most water supplies also use chemical disinfection to provide further inactivation of bacteria and viruses and protection of the distribution system. Both of these common practices make photo repair unlikely to be an issue. One study showed that *Cryptosporidium* can undergo some DNA photo repair. Even though the DNA is repaired, infectivity is not restored
- dark repair is also not a concern because the required UV doses are derived from data that are assumed to account for dark repair.

Table 15.10 includes data from Table 7.6 in WHO (2004). See Table 15.1 for some earlier data. The table presents conservative estimates of microbial reductions based on the more resistant or persistent pathogenic members of the group. See next section why various standards require much more than 10 mJ/cm<sup>2</sup> for inactivation of *Cryptosporidium*.

**Table 15.10: UV irradiation doses required for 99 percent inactivation (2 logs)**

| Micro-organism         | Dose                  |
|------------------------|-----------------------|
| Bacteria               | 7 mJ/cm <sup>2</sup>  |
| Viruses                | 59 mJ/cm <sup>2</sup> |
| <i>Giardia</i>         | 5 mJ/cm <sup>2</sup>  |
| <i>Cryptosporidium</i> | 10 mJ/cm <sup>2</sup> |

A more complete table was compiled in DWI (2016a, Table C.1), and copied here as Table 15.11. Table C.2 in DWI (2016a) covers inactivation of many bacteria and their spores.

**Table 15.11: UV dose (mJ/cm<sup>2</sup>) for inactivation of protozoa and viruses**

| Target                          | Log <sub>10</sub> inactivation |     |     |      |     |       |     |      |
|---------------------------------|--------------------------------|-----|-----|------|-----|-------|-----|------|
|                                 | 0.5                            | 1.0 | 1.5 | 2.0  | 2.5 | 3.0   | 3.5 | 4.0  |
| <b>Protozoa</b>                 |                                |     |     |      |     |       |     |      |
| <i>Giardia</i>                  | 1.5                            | 2.1 | 3.0 | 5.2  | 7.7 | 11    | 15  | 22   |
| <i>Cryptosporidium</i>          | 1.6                            | 2.5 | 3.9 | 5.8  | 8.5 | 12    | 15  | 22   |
| <b>Viruses</b>                  |                                |     |     |      |     |       |     |      |
| "Viruses"                       | 39                             | 58  | 79  | 100  | 121 | 143   | 163 | 186  |
| Adenovirus type 40 <sup>2</sup> |                                | 56  |     | 111  |     | 167   |     |      |
| Poliovirus <sup>2</sup>         |                                | 7   |     | 15   |     | 22    |     | 30   |
| Adenovirus type 41 <sup>3</sup> |                                |     |     |      |     |       |     | 112  |
| Hepatitis A <sup>3</sup>        |                                |     |     |      |     |       |     | 21   |
| Coxsackie virus B5 <sup>3</sup> |                                |     |     |      |     |       |     | 36   |
| Poliovirus type 1 <sup>3</sup>  |                                |     |     |      |     |       |     | 27   |
| Rotavirus SA11 <sup>3</sup>     |                                |     |     |      |     |       |     | 36   |
| Murine norovirus <sup>4</sup>   |                                | 7.3 |     | 14.6 |     | 21.9  |     | 29.2 |
| Feline calicivirus <sup>4</sup> |                                | 6.3 |     | 12.5 |     | 18.8  |     | 25   |
| Echovirus 12 <sup>4</sup>       |                                | 7.4 |     | 14.8 |     | 22.23 |     | 29.6 |

1 USEPA (2006)

2 Hijnen WAM, Beerendonk EF and Medema GJ (2006)

3 Bolton JR and Cotton CA (2008)

4 Park GW, Linden KG and Sobsey MD (2011)

### 15.5.5.1 The UV disinfection process

#### Germicidal effects of UV light

UV light can be categorised as UV-A, UV-B, UV-C or vacuum-UV, with wavelengths ranging from about 40 to 400 nm. The UV light effective for inactivating micro-organisms (the germicidal range) is in the UV-B and UV-C ranges of the spectrum (200–310 nm), with maximum effectiveness around 265 nm. Thymine bases on DNA and ribonucleic acid (RNA) are particularly reactive to UV light and form dimers (thymine–thymine double bonds) that inhibit transcription and replication of nucleic acids, thus rendering the organism sterile, ie, a micro-organism cannot infect a host because it cannot replicate. Thymine dimers can be repaired in a process termed photo reactivation in the presence of light, or dark repair in the absence of light. As a result, the strategy in UV disinfection is to provide a sufficiently high dosage to ensure that nucleic acid is damaged beyond repair. Taken from WHO (2004b), Chapter 3.3.5.

All the light produced by low pressure UV lamps is within the germicidal range. Medium pressure lamps produce some light outside the germicidal range so require more electricity for a given duty compared with low pressure lamps. Three types of lamps are used:

- **Low-pressure (LP) lamp:** a mercury-vapour lamp that operates at an internal pressure of 0.13 to 1.3 Pa and electrical input of 0.5 watts per centimetre (W/cm). This results in essentially monochromatic light output at 254 nm. These are commonly used on smaller supplies. They have the highest energy efficiency of the three types of mercury vapour lamp, but another important characteristic, given the discontinuous usage pattern of the typical domestic water supply, is their relatively low operating temperature; lamps which run hotter are more dependent on continuous water flow to dissipate the heat generated; DWI (2016a).
- **Low-pressure high-output (LPHO) lamp:** low-pressure mercury-vapour lamps with heavy duty electrodes that operate under increased electrical input (1.5 to 10 W/cm), resulting in a higher UV intensity than low-pressure lamps. They also have essentially monochromatic light output at 254 nm. They run hotter than LP lamps. They are being used increasingly by the larger water suppliers.
- **Medium-pressure (MP) lamp:** a mercury vapour lamp that operates at an internal pressure of 1.3 to 13,000 Pa and electrical input of 50 to 150 W/cm. This results in a polychromatic (or broad spectrum <200 nm to >400 nm) output of UV and visible light at multiple wavelengths, including wavelengths in the germicidal range. MP lamps have a much higher output than LP lamps but are less efficient in converting electricity into germicidal UV. Fewer MP lamps are required for a given duty than LP or LPHO lamps because of the higher output. They are used by the bigger supplies when the higher electricity cost can be offset against lower capital cost (smaller plant, smaller building to house the plant) and lower maintenance cost (because of the lower number of lamps); DWI (2016a).

**LED (light emitting diode) technology** represents the most likely alternative to the mercury vapour lamp in the future. LEDs are configurable, switchable and don't require the warming up period of mercury vapour lamps. They are safer to handle (no glass or mercury). However, efficiencies are <10%, lifetimes limited to about 1,000 hours and production costs are high. Very small-scale LED UV devices (eg, for laboratory use) are available, but further development will be necessary for larger-scale devices to be both technically and economically viable (DWI 2016a).

### Dose (fluence)

The amount of inactivation that is achieved is a function of the amount of UV light that the micro-organisms receive. This is called the UV dose, or more correctly, the fluence. The SI units of UV dose are J/m<sup>2</sup>. The units of mJ/cm<sup>2</sup> are also used. One mJ/cm<sup>2</sup> is equal to 10 J/m<sup>2</sup>.

The dose is the product of the intensity of UV light and the time that the micro-organisms are exposed to it. The unit of intensity is watts (W). The unit of time is seconds (s). Consequently the dose is sometimes referred to as mW.s/cm<sup>2</sup> or W.s/m<sup>2</sup>. One mJ/cm<sup>2</sup> is equal to 1 mWs/cm<sup>2</sup>.

It has been shown (Buhkari et al 1999) in ideal laboratory collimated beam studies that UV light can provide a 4-log inactivation of *Cryptosporidium* at received UV doses less than 20 mJ/cm<sup>2</sup>. It is generally considered that a received UV dose of 12 mJ/cm<sup>2</sup> can produce a 3-log inactivation of *Cryptosporidium* (USEPA 2003a and 2006).

It is normally very difficult to assess the UV dose that is being provided by a UV reactor because there are many uncertainties. The uncertainties include hydraulic flow paths, the response of the sensor to different angles of light, different water qualities and variation in lamp output. Reactors are typically validated (or certified) to provide a reduction equivalent dose (RED). (The RED is a calculated dose for a flow-through UV reactor that is based on biosimetry). The dose required for a given log inactivation in the commonly used LT2ESWTR tier 1 approach, the German DVGW Technical Standard W294 approach and the Austrian ÖNORM M5873-1 approach, is at least three times greater than the received UV dose that is found in collimated beam studies (compare with data in Table 15.10). The much higher dose accounts for the uncertainty in the reactor and ensures that the required level of inactivation is achieved.

The dose required to inactivate adenoviruses in laboratory tests has been found to be an order of magnitude higher than the dose required for *Cryptosporidium*. For this reason UV disinfection is not currently considered to be effective for inactivation of all viruses. Table 1.4 in USEPA (2006) states that a dose of 39 mJ/cm<sup>2</sup> will only achieve 0.5 log inactivation of virus and that 3 logs require a dose of 143 mJ/cm<sup>2</sup>. Note however that the USEPA Table is based on adenovirus, the most resistant type. Figure 2.8 (Shapes of UV Dose-Response Curves), in the same manual shows a curve for rotavirus that implies that a dose of 40 mJ/cm<sup>2</sup> may achieve about 4 log inactivation of rotavirus. Figure 2.8 is followed by this paragraph:

Microbial response to UV light can vary significantly among micro-organisms. The UV sensitivity of viruses and bacteriophage can vary by more than two orders of magnitude (Rauth 1965). With bacteria, spore-forming and gram-positive bacteria are more resistant to UV light than gram-negative bacteria (Jagger 1967). Among the pathogens of interest in drinking-water, viruses are most resistant to UV disinfection followed by bacteria, *Giardia* cysts, and *Cryptosporidium* oocysts.

## A UV disinfection system

A typical system for drinking water disinfection will consist of the following elements:

- the shell of the pressurised UV reactor
- UV lamps
- quartz sleeves
- UV ballasts
- UV intensity sensors mounted inside the UV reactor
- a control panel
- a cleaning device.

UV disinfection of drinking-water is typically achieved in an enclosed, pressurised reactor (or appliance). While it is possible to use open channel UV disinfection, this approach is rare in drinking-water applications and is not discussed further.

The enclosed reactor contains UV lamps that produce photons of UV energy by applying a voltage across a mercury gas mixture. Low mercury vapour pressures of 0.001 to 0.01 torr (SI units: 0.13 to 1.3 Pa) and a temperature of 50–100°C will produce essentially monochromatic UV light at around 253.7 nm. At higher vapour pressures from 100–10,000 torr (SI units 13 – 1.3 x 10<sup>3</sup> kPa) and temperatures of 600–900°C the lamps will produce UV light over a broad spectrum and are commonly called medium pressure lamps. Low pressure lamps are further divided into historic low output lamps and the new high output (or intensity) lamp (LPHO). Most low pressure UV systems now use LPHO lamps and low intensity lamps are not discussed further.

UV lamps will degrade with time, producing less UV light per unit of electricity used. A lamp is usually considered to have reached the end of its life when the UV output has dropped to 70–80 percent of its output following burn-in. The elevated operating temperature of the lamp when it is running, and also the number of starts that the lamp has been through, cause the degradation. Manufacturers will provide a guarantee on the number of hours that a lamp will run before its output is reduced to 70 or 80 percent of the output achieved after around 100 hours of operation. The guarantee will normally specify a maximum number of starts per day for the lamp.

LPHO lamps are more efficient at turning electricity into germicidal light, so they have lower electricity costs. They operate at a lower temperature, so their expected lifetime is significantly longer and also they are not affected by fouling as much as medium pressure lamps.

The advantages of medium pressure lamps include higher UV output per lamp than lower pressure lamps, so fewer lamps, ballasts, and sensors need to be installed. It also means that the reactor will require less space. Fewer lamps can also mean there is less water pressure loss.

The choice between LPHO and medium pressure lamps is site-specific. Once manufacturers have guaranteed prices and lifetimes for all the items of equipment, a financial comparison between the two is possible. The site-specific issues that affect the decision include the temperature of the raw water, the chemicals that cause fouling in the water, and whether there is a certified/validated reactor that matches the required duty. Other site-specific issues such as the available space or water pressure may also influence this decision.

Quartz sleeves surround the lamps and separate them from the water. O-rings are used to seal the end of the quartz sleeves. The surface of the quartz sleeve that is exposed to water can become fouled. This is discussed below. Generally fouling occurs more rapidly on sleeves surrounding medium pressure lamps because they operate at a higher temperature, and solubility of CaCO<sub>3</sub> decreases with increasing temperature.

The ballasts regulate the power supply at the appropriate level needed for energising and driving the UV lamps. UV reactors may use electronic ballasts, electromagnetic ballasts or transformers. The benefits of different types of ballasts can be explored with the manufacturer.

The control panel may consist of a programmable logic controller (PLC) or a simpler device for recording and displaying the intensity and lamp status. Some control systems are capable of varying the output of the UV lamps to reduce the amount of electricity that is used. Large reactors that have more than one group of lamps may use the control system to turn off banks of lamps when low flows or high quality water mean that they are not all required.

The cleaning system needs to clean the outside of the quartz lamps and the window over the UV intensity sensor. There are two common types of cleaning devices. One uses mechanical cleaning by a rubber wiper that is automatically moved up and down inside the reactor. Some mechanical systems also have an acid in the wipers to assist the cleaning process. The second method is to isolate the reactor and then circulate an acid solution through the inside of the reactor. The acid cleans the internal surfaces, then drained from the reactor that is flushed and put back into service. The chemical method of cleaning requires the reactor to be taken out of service.

### 15.5.5.2 Water quality

A number of water quality factors can affect the performance of the UV disinfection process.

#### UV transmittance

Light emitted from a UV lamp that is absorbed by substances in the water flowing through the reactor is not available to inactivate micro-organisms. This loss of UV light is the most important water quality parameter for the design of UV disinfection systems. The quality of the water is defined by the amount of UV light at a wavelength of 254 nm that passes through a certain path length of water compared with the amount that passes through the same path length of distilled water. This is typically called the transmittance (T) of the water. The path length that is most commonly used is 10 mm and this is often shown with a subscript ie,  $T_{10}$ . For example if the water allows 94 percent of light at a wavelength of 254 nm to pass through a 10 mm path length then the UV transmittance is called 94 percent or  $T_{10} = 94$  percent, or  $UVT = 94$  percent in a 10 mm cell.

While transmittance is generally related to a 10 mm path length there are other ways of defining it. For example, it may be referred to as the spectral absorption coefficient (SAC) at a wavelength of 254 nm. This represents the absorbance over a one metre path length. The SAC can be converted to a transmittance over a 10 mm path length by the equation  $T_{10} = 10^{-(SAC/100)}$ . See Chapter 8, section 8.4.4.3, sub-heading UV transmittance for an example of converting from the European SSK unit; SAC is the English translation of SSK.

Another common source of confusion in New Zealand has been referring to the transmittance over a longer path length. The conversion from a transmittance over a path length of  $x$  ( $T_x$ ) to  $T_{10}$  can be achieved using the equation  $T_{10} = T_x^{(10/x)}$ . For example, a transmittance of 90 percent over a path length of 100 mm ( $T_{100} = 90\%$ ) is equal to  $T_{10} = 90\%^{(10/100)} = 98.95\%$ . For reasons of consistency, transmittance should really be reported for a path length of 10 mm.



The UV transmittance has a large effect on the size of the UV reactor required. A decrease of the UV transmittance from 92 percent  $\text{cm}^{-1}$  to 90 percent  $\text{cm}^{-1}$  will change the size of the required reactor by more than 25 percent. The large effect of UV transmittance on the size of the equipment required means that detailed knowledge of the water quality is required before purchasing a UV system. Ideally continuous UVT data of the water to be treated should be obtained over a 12-month period. If this is not possible then regular sampling must be carried out at different times of the day during different seasons and raw water conditions.

Transmission is sometimes measured as absorbance. Appendix A1.5.9 of the DWSNZ shows the conversion; the basic equation is  $\text{UV abs} = -\log_{10}T$ .

An indication of the UV absorbance or UVT likely to be found in different waters follows (all based on measurements at 254 nm with a 10 mm path length):

| UVT  | UV abs | Typical raw water   |
|------|--------|---|
| 1.00 | 0      | Distilled water; maybe rainwater                                    |
| 0.98 | 0.009  | Lake Taupo; clean bore water  |
| 0.94 | 0.027  | Clean stream water; water after alum coagulation and filtration     |
| 0.90 | 0.046  | River water when not in flood                                       |
| 0.85 | 0.071  | Lake water when catchment not heavily bushed                        |
| 0.80 | 0.097  | Lake water from bush catchment                                      |
| 0.75 | 0.125  | Lake water from heavily bushed catchment; streams from beech forest |

Section 5.16.1 of the DWSNZ specifies the UVT requirements. Chapter 8, section 8.4.4.3 of the Guidelines discusses compliance requirements in more detail.

### Water treatment chemicals that lower the UV transmittance (ie, raise the absorbance)

Most water treatment chemicals do not significantly impact UV transmittance. Those that may, include hypochlorite ions, ferric ions, permanganate and ozone. The effect of hypochlorite ions is minimal and a free available chlorine concentration of 3.5 mg/L will only reduce the  $T_{10}$  by around 1 percent (Cushing et al 2001). Care should be taken to ensure that permanganate and ozone are not present at the point where UV disinfection is going to be installed. A concentration of 0.057 mg/L ferric iron will reduce the UVT by 1 percent, ie, raise the UV absorbance from 0.041 to 0.046 in a 1 cm cell (USEPA 2006a).

The lime dosing point should not be immediately upstream of the UV reactors as it may raise the turbidity.

### Turbidity

Turbidity is the most common indicator of water quality used in New Zealand. The effect of turbidity on UV disinfection is related to the shielding and shading effects that limit potential inactivation of micro-organisms. The DWSNZ require that water being

disinfected with UV light has a turbidity of less than 1.0 NTU for 95 percent of the time and never has a turbidity of more than 2.0 NTU.

## Temperature

Low temperatures affect the output of UV lamps. This effect is greater for LPHO lamps than for medium pressure lamps. In most applications the temperature of the water will be warm enough that there is no noticeable effect on the output of the lamps. The effect of water temperatures less than 10°C should be discussed with UV lamp manufacturers. Many New Zealand water supplies are less than 10°C for a lot of the year.

## Chemicals that cause fouling of quartz sleeves

Many substances cause coatings or deposits to form on surfaces when water containing them flows past. The deposition can occur more rapidly if the surface has a higher temperature. The surface of the quartz sleeve is submerged in water and is at an elevated temperature due to the operating temperature of the lamps. The deposition of solids on the outside of the quartz sleeve can absorb or reflect UV light, thereby reducing the effectiveness of disinfection. Once the absorption of light reaches a level where the intensity measured by the UV intensity sensor is too low, the sleeves must be cleaned using a cleaning system such as those described above.

Water quality parameters that can increase the rate of build-up on quartz sleeves include high levels of:

- calcium
- alkalinity
- hardness
- iron
- pH (an indirect effect)
- natural organic matter.

## Information to UV manufacturers

Information on the above parameters should be provided to manufacturers when specifying the requirements for a UV system. The end-user should specify the design water quality parameters. This should include an absolute statement of the design UV transmittance but percentile values should be provided for other parameters. The end-user must define the design UV transmittance based on operational requirements and the acceptable risk of off-specification water.

Raw water quality information should cover all possible conditions, preferably spanning at least one year for surface water supplies. Any other available water quality data should also be supplied. The additional data may not be used, but provision of information to all parties can only benefit the final installation.

## Performance validation/certification

Refer to Chapter 8: Protozoa Compliance, section 8.4.4.3.

### 15.5.5.3 Design, installation and commissioning issues

The installation of a UV reactor must comply with its own technical requirements, interact correctly with the other aspects of the treatment process and comply with the conditions for which the reactor was validated. The following are some guidelines for the design of installation of UV reactors.

#### Redundancy

Good engineering practice should be followed with redundancy for UV reactors. Redundancy should consider the effect of shut-down of the reactor system for routine cleaning (if required) and for changing of lamps. Redundancy also needs to consider the failure of the equipment and the time required for operators to attend to repair the equipment. Spares should be carried onsite. UV systems are relatively easy to service.

#### Hydraulics

It is very important that the upstream, and to a lesser degree, downstream hydraulic flow conditions are at least as good as those under which the reactor was validated. Better hydraulic flow conditions provide a more even cross-sectional velocity distribution and provide more efficient and reliable disinfection. The hydraulic conditions that were used in the validation procedure need to be identified so that the installation can be designed appropriately.

If there is to be more than one duty UV reactor to treat a given flow of water then the splitting of the flow between the reactors must be considered to lower the maximum instantaneous flow rate that will go through one reactor. Flow splitting can be achieved passively by providing equal restriction to flow in parallel routes between two points of equal pressure or can be achieved using flow meters and control valves. If a control valve is being used for flow modulation it should be installed downstream of the UV reactor.

The pressure drop across the UV reactor will normally be 150–1000 mm of water head. The exact drop needs to be incorporated into the hydraulic profile of the WTP. The headloss associated with valves, pipe-work bends, expansions, contractions etc also needs to be considered.

UV reactors must be completely full. If not, overheating of the casing and lamps may occur, one possible outcome being release of mercury. This can be achieved by ensuring that the downstream discharge is higher than the highest point on the UV reactor. Low level switches and temperature sensors on the top of the UV reactor can also be installed to safeguard the reactor against operation without full flow. When appropriate, air valves should be installed on the high point of UV reactors to release entrained gases.

Most UV reactors, especially medium pressure reactors, require flow at all times to ensure that sufficient cooling is supplied to the lamps. The designer should consult with the manufacturer to determine the length of time that flow can be stopped without overheating the system.

The system can be designed with a means to stop off-specification water from reaching the reticulation. Different ways to achieve this can include starting a standby reactor, or bank within a reactor, upon failure of a UV reactor and diverting water to waste if it is detected as off specification. The implication of any reduction in water supply needs to be considered.

UV reactors will only be rated for operation with a certain pressure of water. The allowable operating pressure should be checked with the manufacturer.

Isolation valves are required for UV reactors. Automatic isolation can be included to minimise the production of off-specification water. The implications of automatic flow isolation and flow restriction on the hydraulic grade and operation of the WTP must be considered.

### Start-up and cool-down

All UV reactors require time for lamps to heat up before they can produce their rated UV light output. Generally this is about five minutes. Some lamps need to cool before they can restart. Both conditions should be confirmed with the manufacturer. The implications of the delay for start-up and cool down need to be incorporated into the UV system design, particularly in terms of continuity of power supply and reaction to off-specification water.

### Electrical design

If there are voltage variations in the power supply, lamps may lose their arc and need to restart. This can take 10–20 minutes. The quality of the power supply must be checked to ensure that this will not happen. Outages of power will stop the UV system and require the cool down and start-up process. The likelihood and effect of a power loss should be considered, and if required an un-interruptible power supply may need to be installed.

The end-user must determine the requirements of the control system to operate the UV reactors. The control system may conduct such functions as controlling the output of UV lamps, changing the number of banks that are in operation, monitoring of instrument readings, sending alarms to operators, recording lamp run hours, monitoring lamp status.

### Alarms

Section 4.3.3 of the USEPA UV Guidance Manual breaks alarms into three classes:

- A minor alarm generally indicates that a UV reactor requires maintenance but that the UV reactor is operating in compliance. Minor alarms also can be set for conditions just short of failure conditions so that major alarm conditions are not reached. For example, a minor alarm would occur when the UVT is within 1 percent UVT of the minimum allowed UVT or when the end-of-lamp-life based on hours of operation is reached, indicating the possible need for lamp replacement.
- A major alarm indicates that the UV reactor requires immediate maintenance (eg, the UV sensor value has dropped below the validated setpoint) and that the unit

may be operating off-specification. Based on the water supply's disinfection objectives, this condition may also be handled as a critical alarm.

- A critical alarm typically shuts the unit down until the cause of the alarm condition is remedied. An example of a critical alarm is the UV reactor's temperature exceeding a pre-determined maximum value, resulting in automatic shut-down to prevent overheating and equipment damage.

To maintain reactor integrity and compliance with the DWSNZ, the designer needs to decide which conditions require a visual or audible type of alarm, or set off a pager, or shut the system down. Alarm conditions should be recorded, and their causes reported.

#### 15.5.5.4 Operational activities

Operational staff should carry out daily checks of the UV system. These checks should be fully described in the operation manuals. These checks should include a visual inspection of the reactors and piping and a check of the status of the system and lamps. The operator should also manually purge from the top of the UV reactors at regular intervals to determine if there is any air build-up.

The commonest causes for poor disinfection include using lamps beyond their prescribed life, poor upstream treatment, and build-up of film or sediment in the appliance, often caused by clay, iron, manganese or lime. Inadequate attention to these matters readily causes the system to fail. *E. coli* were often found in small water supplies using UV disinfection during the 1990s, giving the process an undeserved bad reputation.

The operator should regularly review operational data such as the UV intensity, the flow rate, the UV transmittance and the electricity usage. If variable output lamps are installed the operator should also review the lamp output that is being selected by the control system. Operational staff should aim to detect any anomalies in the data and investigate them. This may lead to early detection of a problem.

Chemical cleaning of the reactors should be conducted initially three-monthly. The operational staff should record the intensity immediately before and after a cleaning event in order to evaluate the magnitude of fouling that is removed and to determine how frequently cleaning is required. This information should be recorded in the operation and maintenance manuals. If there is little build-up on the sleeve surfaces then the cleaning frequency could be reduced.

Operational staff could track the degradation of lamp output by observing the intensity that is recorded after cleaning events. When doing so the effect of UV transmittance will need to be taken into account. In addition the operator should frequently review the lamp run time and compare the hours run with the hours expected to the end of lamp life output.

The ballast cooling fans should be inspected at regular intervals to check their operation and ensure there is no build-up of dust.

The operational staff should check to ensure that algae are not growing in the light provided by the UV. This will not be a problem if a chlorine residual is carried through the UV reactors; however, this is not normal practice.

The standardisation of any online UV transmittance monitors should be checked using grab samples of the water on a weekly basis.

Other operational activities will include replacement of lamps and calibration of the UV intensity sensors. These activities should be conducted following the requirements of the validation, the DWSNZ, and the manufacturer's instructions.

### Control limits

The process control limits (or parameters that must be monitored to ensure that the dose is being delivered) are the UV intensity or dose, the flow through each reactor, and the UV transmittance. The UV intensity and the flow are limits because they are directly related to the dose delivered. The UV transmittance is a limit because it can affect the sensitivity of the UV intensity sensor. The values for these control limits are defined in the certification procedure. Operational staff should monitor these process control limits and record any transgressions.

Staff should also establish operational control limits that act as an early warning that disinfection conditions are approaching the stage where some adjustment may be needed, thereby avoiding transgressions, and to ensure that these do not become a non-compliance. Measures that can be taken, and recommended actions, should be itemised in the WSP.

### Safety

UV light is dangerous. The manufacturer's instructions must be followed.

Lamp breakages in reactors may result in a risk to human health through exposure to mercury in the water supplied. Lamps and sleeves may both be liable to break as a result of:

- the impact of debris in the water
- excessive water hammer
- differential or over-heating
- mechanical forces such as wiper jams.

Correctly applied operating procedures should be in place to minimise the risk of breakages and appropriate monitoring should be in place to detect breakages. Water suppliers are expected to have documented action plans for identifying and responding to on-line lamp breakages. DWI (2016b).

## 15.5.6 Bromine

The decision on whether bromine can serve as a disinfectant for drinking-water and wastewater treatment is likely to be a balance between the dose required to achieve efficacy, its advantages over other disinfectants, particularly chlorine, aesthetic impacts, preventing potential adverse health effects from chronic exposure, and cost. Any potential risk of adverse effects should be considered in context of the benefit of water

disinfection which should always take precedence. Bromine disinfection is superior to chlorine for microbiological inactivation when applied to low quality water containing ammonia and other nitrogenous components. This may give support for the use of bromine as a potential alternative to chlorine in disaster relief scenarios, however, further investigations would be required. Also, these potential benefits should be balanced with the significant issues surrounding the ease and safety of bromine generation and its subsequent use for water purification purposes. Practical handling of free bromine is a safety issue; it is usually combined with dimethylhydantoin (DMH), an organic carrier (WHO 2018).

Bromine is a good germicidal agent with disinfecting powers similar to chlorine at the same pH. In a similar way to chlorine, bromine reacts with ammonia to form bromamines. Unlike the chloramines, which are much poorer disinfectants than chlorine, monobromamine and bromine have similar germicidal properties. Ammonia in the water, therefore, does not have the adverse impact it does for chlorine.

Bromine appears to be effective against cysts of the protozoan parasite *Entamoeba histolytica*, and there is some evidence of limited effectiveness against oocysts of *Cryptosporidium parvum*; studies on the efficacy of bromine against *Giardia* cysts were not available (WHO 2018).

Elemental bromine was evaluated in a series of batch tests where it was found that a dose of at least 1 mg/L and a contact time of 1 hour was required to achieve 5 log reductions of *E. coli* (Patil et al 2013).

The datasheet for bromine covers health issues. Toxicity studies in humans or animals for bromine per se via ingestion are very limited; this is mostly due to the corrosiveness and high reactivity of bromine; it quickly forms bromide in living tissues. The greatest potential concern to humans from using bromine as a drinking-water disinfectant may stem from the generation of brominated DBPs. The formation of brominated DBPs during water disinfection with chlorine has been well studied. There are toxicity data in some of these studies that indicate that brominated DBPs may be more toxic in some respects than their chlorinated analogs. Currently the potential for formation of brominated DBPs from the use of bromine as an alternative drinking-water disinfectant in POU devices has not been comprehensively addressed, although some devices have been shown to produce minimal amounts of brominated products (WHO 2018).

Bromine is rarely used to disinfect potable waters because of its cost and the difficulties in handling the very corrosive bromine liquid. Compounds containing active bromine, such as the dibromo- and bromochloro-methylhydantoins (eg, N-bromo-N-chloro-5,5-dimethylhydantoin) or dibromocyanuric acid are used to treat swimming pools. See datasheets.

## 15.5.7 Iodine

Iodine-based disinfection of water has a long history: iodine in concentrations between 2.5 to 7 mg/L have been used for potable water treatment since the early 1900s, especially for military operations. Also, in more recent times, iodine (and bromine) has become attractive for particular applications. Elemental iodine is used, for example, as

a drinking-water disinfectant aboard space vessels at a residual concentration of approximately 2 ppm. The more general use of iodine is impeded, however, by the potential for excess iodine intake, cost and the possibility of the formation of toxic DBPs. Iodine may provide superior disinfection to chlorine for water of poor quality. The reduced overall reactivity of iodine prompts slower reactions with organic material and thus a lower disinfectant demand. The low reactivity with organic nitrogenous contaminants results in improved maintenance of residual iodine concentrations (WHO 2018).

Iodine, like two other halogens, chlorine and bromine, is a good disinfectant, but is rarely used in potable water treatment, except in some instances for the treatment of very small supplies. The main drawbacks to its use are its cost, the iodine taste it imparts, and the possible health effects associated with its long-term use. See datasheets. It can be used for emergency disinfection. Its disinfecting power is pH sensitive. Iodine is not effective against *Cryptosporidium*, and needs a longer contact time to inactivate *Giardia* than when used to inactivate bacteria. It has some effectiveness against viruses. A fairly common form of commercially available iodine is tetraglycine hydroperiodide.

Iodine, as a 2 percent tincture, was evaluated in a series of batch tests where it was found that a dose of at least 0.5 mg/L and a contact time of 30 minutes was required to achieve 5 log reductions of *E. coli* (Patil et al 2013).

The Utah State Government has deemed that iodine disinfection is no longer allowed in public water supplies because of adverse health implications for the public.

The World Health Organization (WHO 2005) states that iodine use (to disinfect water) over a long period of time is not recommended for infants or pregnant women, those with a history of thyroid disease, and those with known hypersensitivity to iodine. Excess iodine can interfere with the functioning of the thyroid gland. Travellers intending to use iodine daily for all water consumed for more than 3–4 weeks should consult their physician beforehand, and not use it in excessive amounts when treating drinking-water. Remove excess iodine by carbon filtration. It may be possible to purchase iodine taste and odour neutralising tablets (usually ascorbic acid) – follow the instructions.

Health Canada states that iodine disinfection of drinking water should be reserved for emergency and occasional use (eg, at a weekend cottage or in recreational vehicles). Iodine should not be used for long-term continuous disinfection because it is physiologically active, and ingestion in excessive amounts may be harmful.

The US Army (USAPHC) issued iodine-based tablets to American Soldiers in 1952 and continues to provide the tablets in addition to other emergency field drinking water products. Iodine-based products can be divided into two categories; iodine solutions and iodine resins.

Iodine solutions are made by adding iodine (eg, tincture of iodine, a 2 percent iodine solution), or by adding a tablet containing iodine along with carrier and stabilising agents to enhance dissolvability. Iodine resins are solid-phase iodine disinfectants. Iodine resins are used by passing water through the resin where disinfection occurs through direct contact of the microorganism and the iodine sorbed on to the resin.



Iodine resins are generally considered demand-release disinfectants; they generally produce a dilute iodine residual.

When iodine is added to water, it may remain unchanged or it may hydrolyse into five different species depending on pH and the initial iodine concentration. The main reaction is:



At pH levels above 8, biocidal capability may drop sharply because HOI becomes unstable and decomposes to iodate and iodide, which are not effective biocides. In addition to the formation of hypiodous acid (HOI) and iodide ion ( $I^-$ ), hypiodite ion ( $OI^-$ ), triiodide ion ( $I_3^-$ ), and iodate ( $HIO_3$ ) may be formed. Under typical concentrations used in drinking water disinfection, and at typical pH ranges for natural water sources, hypiodite ion, triiodide ion, and iodate are not considered to be formed at any appreciable concentrations. Only iodine and hypiodous acid are capable of biocidal activity. Iodine is up to three times more cysticidal and six times more sporocidal than hypiodous acid. Hypiodous acid, on the other hand, is 40 times more virucidal and up to four times more bactericidal than iodine.

Preparation of iodine resins involves binding polyiodide ions to a strong-base anion resin, creating a positively charged resin. Most microorganisms are negatively charged at typical pH levels encountered in natural waters. These opposite charges produce an electrostatic attraction that helps bring the microorganism into direct contact with the iodine resin. There are generally two types of iodine resins produced for drinking water treatment, a triiodide ( $I_3^-$ ) and a pentaiodide ( $I_5^-$ ) resin; pentaiodide resin has been shown to have better biocidal capabilities than triiodide resin. Resins do not appear to be as affected by pH or low temperature.

Most manufacturers of iodine solution systems recommend dosages between 4 and 16 mg/L with contact times ranging from 20–35 minutes, resulting in C.t.s of 80–560 mg-min/L. The use of POU devices using iodine should be appropriately approved or certified to ensure efficacy and safety.

See Chapters 7 and 8 for the effect of iodine on viruses and protozoa.

## 15.5.8 Potassium permanganate

Potassium permanganate is a moderately strong oxidant sometimes used as a pre-oxidant to aid in the removal of iron and manganese, and tastes and odours. It may oxidise some organic substances that would otherwise react with chlorine to form disinfection by-products. Its disinfecting ability however is poor, and is strongly influenced by the pH. High pH levels severely reduce its germicidal properties. High pH enhances the oxidation of organic matter. Potassium permanganate might be used in emergencies, but even then only in small supplies.

Potassium permanganate is used as a pretreatment before physical treatment processes, because the insoluble brown, or brown-black manganese oxides produced from it have to be removed before the water passes into the distribution system. Care

must be taken not to overdose permanganate, as it imparts a pink colour to the water, hence it is impracticable to maintain a disinfecting residual.

Refer to the Alternative Disinfectants and Oxidants Guidance Manual USEPA (1999) for further information.

## 15.5.9 Hydrogen peroxide

Hydrogen peroxide has been used as a general disinfecting agent for more than a century, but its use in the treatment of potable water has been very limited. This is in part due to its instability in storage and the difficulty in preparing concentrated solutions. It is a strong oxidising agent, but a poor disinfectant achieving little or questionable inactivation of bacteria, protozoa and viruses. It might be used in emergencies, but even then only in small supplies.

Hydrogen peroxide, as a 30 percent solution, was evaluated in a series of batch tests where it was found that a dose of at least 1000 mg/L and a contact time between 0.5 to 1 hour was required to achieve 5 log reductions of *E. coli* (Patil et al 2013). At this dose it would be very expensive.

Although of little value itself, hydrogen peroxide has been used in conjunction with other disinfectants to achieve improved oxidation of organic matter. Its use with ozone and ultraviolet light (see section 15.5.11) produces increased concentrations of hydroxyl radicals. These are short-lived, very strongly oxidising chemical species, which react with the organic matter.

## 15.5.10 Silver and other metal ions

Metal ions exhibit low biocidal activity, and are poor oxidising agents, unlike the more commonly used water disinfectants. However, silver has been known to have antibacterial properties since Roman times. The increased use of nanosilver in a range of (as yet largely) experimental drinking-water treatment systems, its use in conjunction with ceramic filters, and its perceived potential to be a water disinfectant that does not result in disinfection by-products in the treated water, have raised the profile of this chemical (WHO 2018). See also datasheet for nanoparticles.

The slow rate of inactivation of micro-organisms by silver requires long contact times to achieve adequate disinfection. Synergistic effects that improve the efficacy of metal ions as disinfectants have been reported in mixes of metal ions (eg, silver and copper, Pyle et al 1992) or mixes of peroxy-compounds and metal ion (eg, silver and hydrogen peroxide, Armon et al 2000). Although the rates of disinfection achieved by these mixtures are still low compared with those of the halogens and their compounds, and ozone, they produce long-lasting residuals that provide some control of biofilms.

Silver, as a solution of silver nitrate, was evaluated in a series of batch tests where it was found that a dose of at least 20 mg/L and a contact time of two hours was

required to achieve 5 log reductions of *E. coli* (Patil et al 2013). A dose of 10 mg/L was possible when using nano-silver.

The World Health Organization (WHO 2005) states that, contrary to widespread perception, silver is not an effective disinfectant (particularly so regarding *Cryptosporidium*) and is thus not recommended for water disinfection. Its presence in some filters is intended only to extend the life of the filter by retarding growth of non-disease causing bacteria that may plug filter pores.

The biocidal efficacy of silver is decreased by low pH and high dissolved solids concentrations, particularly the presence of phosphate. It is not satisfactory for disinfecting drinking-waters because of its slow action, and although it is effective against some bacteria, it is ineffective against others and against viruses. WHO (2018) notes that in the one study on protozoan parasite reduction by silver, there was only limited effectiveness on *Cryptosporidium* infectivity and a log<sub>10</sub> reduction was not documented. For silver ions and nanoparticles, only one study on bacteriophage reduction in water has been reported, with effective log<sub>10</sub> reduction (ie, 3–4 log<sub>10</sub> reductions) by ions and 'biogenic' silver (zerovalent silver nanoparticles on a bacterial carrier matrix) but not by chemically-produced nanoparticles.

It is difficult to draw any strong conclusions about the efficacy of silver (ionic silver and silver nanoparticles) in drinking-water treatment because of the wide range of approaches used in the various studies reviewed. The studies have used different types of silver (silver salts versus silver nanoparticles; capped silver nanoparticles versus bare silver nanoparticles; differently sized silver nanoparticles; silver nanoparticles created using different synthesis methods), different methodologies, different cells and microorganisms, different concentrations of test organisms and exposure for different time periods. Based on the current available evidence, which is particularly limited for viruses and protozoa, silver does not appear to meet the WHO minimum performance recommendations for POU treatment products, which require effectiveness for two of the three pathogen classes (WHO 2018).

A combination of copper and silver ions can inactivate bacteria and viruses, although contact times may be long (hours to days). Low levels of chlorine (0.1 mg/L) combined with silver (0.038 mg/L) and copper (0.38 mg/L) resulted in more than 5-log inactivation of *E. coli* in tap water within 120 seconds.

Silver (0.03 mg/L) and hydrogen peroxide (0.03 mg/L) together provided a long-lasting residual effect capable of more than 5-log inactivation of *E. coli* in phosphate buffer (pH 6.8) after one hour exposure (taken from WHO 2004b, Chapter 3.4.3). Trade literature implies that a dose of 30 mg/L hydrogen peroxide (as H<sub>2</sub>O<sub>2</sub>) plus 0.03 mg/L silver is effective for biofilm control; that sounds rather expensive. One worker considered that the combination was no more effective than hydrogen peroxide on its own, but that maybe the silver stabilised the solution.

A fairly new range of biocides, eg, bismuth-2,3-dimercaptopropanol, are in production, primary for use in water supplies in buildings to control biofilms and slime build up in hot water systems.

Copper has been used in conjunction with SODIS: see section 15.5.6.9.

## 15.5.11 Advanced oxidation processes

Advanced oxidation processes (AOP) generate highly reactive hydroxyl free radicals to oxidise various compounds in the water. Hydroxyl radicals are produced during the spontaneous decomposition of ozone. By accelerating the ozone decomposition rate, the highly reactive hydroxyl radical concentration is elevated, which increases the oxidation rate. This procedure increases the contribution of indirect oxidation over direct ozone oxidation.

Several methods have been used to increase ozone decomposition to produce higher concentrations of hydroxyl radicals. One of the most common of these involves adding hydrogen peroxide to ozonated water, a process commonly referred to as peroxone. Similar results are expected from other advanced oxidation processes such as ozone plus UV, ozone at high pH, hydrogen peroxide plus UV, UV in combination with titanium dioxide (TiO<sub>2</sub>) and other combinations. A wide range of organic and potentially inorganic disinfection by-products are formed.

The UK WRc for DWI (2018) identified 14 AOPs with actual or potential application for drinking water treatment, the main eight being:

|                                  |   |                     |  |
|----------------------------------|---|---------------------|--|
| UV/H <sub>2</sub> O <sub>2</sub> | O <sub>3</sub> /H <sub>2</sub> O <sub>2</sub> | O <sub>3</sub> /UV  | O <sub>3</sub> /UV/H <sub>2</sub> O <sub>2</sub>   |
| UV/Cl <sub>2</sub>               | UV/S <sub>2</sub> O <sub>8</sub>              | UV/TiO <sub>2</sub> | UV/TiO <sub>2</sub> /H <sub>2</sub> O <sub>2</sub> |

Their literature review of the above AOPs identified a total of 78 DBPs, nine of which were prioritised for high level risk assessment. Those where adverse health effects cannot be excluded were (datasheets prepared):

|                               |                             |
|-------------------------------|-----------------------------|
| 2-hydroxy-5-nitrobenzoic acid | 2-methoxy-4,6-dinitrophenol |
| 4-hydroxy-3-nitrobenzoic acid | 4-nitrocatechol             |

The others were (no datasheets):

|                              |                           |
|------------------------------|---------------------------|
| 2-nitrohydroquinone          | 3,5-dinitrosalicylic acid |
| 4-nitrobenzene-sulfonic acid | 4-nitrophthalic acid      |
| 5-nitrovanillin              |                           |

At the time of the study, the only WTPs in the UK using AOP were also using GAC which is likely to have reduced the concentrations of these DBPs.

### a) Peroxone (ozone + hydrogen peroxide)

Research has been carried out into the use of peroxone to control organics and to oxidise taste and odour compounds (eg, geosmin and 2-methylisoborneol [MIB]) while providing sufficient levels of molecular ozone to guarantee C.t values and primary disinfection.

A key issue with the use of peroxone as a disinfection process is that the process does not provide a measurable disinfectant residual. Whereas ozone residuals may persist for 5–10 minutes, hydroxyl radicals are very short-lived. It is therefore not possible to calculate C.t values similar to the use of other disinfectants. While no credit can be given for hydroxyl free radicals because they cannot be measured directly, some credit may be considered for any detected ozone in peroxone systems. Peroxone does provide

pathogen inactivation, but equivalent C.t values or methods of calculating equipment C.t credits have not been established at the date of publication of the guidance document, *Alternative Disinfectants and Oxidants Guidance Manual* (USEPA 1999).

The key difference between ozone and peroxone is in the primary oxidation mode; that is, direct oxidation or hydroxyl radical oxidation. The reactivities of these compounds create a different effect in the reactions with water constituents and, thus, disinfection effectiveness. The peroxone process is a good disinfection process, not as effective as ozone on its own, and can only receive C.t credit if it has a measurable ozone residual.

### b) Ozone + UV light

The USEPA (2003) evaluated a combined UV/O<sub>3</sub> system for disinfecting small supplies. They concluded that the combined system by far achieved the highest removal rates for bacterial contamination, presumably in comparison with chlorine, UV and ozone. A table in their handbook shows that the UV/O<sub>3</sub> system achieved an extra log removal of *Cryptosporidium* too. This may be due to the ozone component increasing the UVT (ie, reducing the UV absorbance).

The combined system is also more effective in removing organic contaminants such as MTBE than using ozone on its own. The handbook did not discuss the effect of varying the relative doses of the UV light and ozone.

DWI (2015a) stated that disinfection doses for UV are typically about 40 mJ/cm<sup>2</sup>, whereas AOP doses are at least an order of magnitude higher.

### c) UV peroxide

A UV peroxide plant was installed at Invercargill's Branxholme WTP for T&O control, followed by a GAC contactor for residual peroxide quenching. The UV peroxide system was able to achieve up to 1.7 log removal of 2-MIB during a peak taste and odour event. The hydrogen peroxide (as a 50 percent solution) dose was about 4 mg/L and the UV dose up to 800 mJ/cm<sup>2</sup>. Plants at Paeroa and Waihi have been in operation over the 2017/18 summer (Stevenson and Zipfel 2018).

## 15.5.12 Mixed oxidants (chlorine-based)

The use of mixtures of oxidants for microbial inactivation has gained attention as a way to maximise the efficiency of current disinfectants, or as some may say, making use of the impurities in the raw ingredients. The chemistry of mixed oxidant production is complex, resulting in a solution of free chlorine, chlorine dioxide, ozone and various oxidation states of chlorine. Using lower grades of salt is likely to generate a range of bromine by-products too. The oxidants can be produced from a sodium chloride brine in an electrolytically generated cell.

Venczel et al (1997) examined the inactivation of *Cryptosporidium* oocysts and *Clostridium perfringens* spores in oxidant demand-free water at pH 7 and 25°C using a disinfectant dose of 5 mg/L and contact times up to 24 hours. Free chlorine produced no measurable inactivation of *Cryptosporidium parvum* oocysts after exposure for

4–24 hours, although *Clostridium perfringens* spores were reduced by 1.4 logs after four hours. In contrast, a mixed oxidant solution resulted in more than 3-log inactivation of both oocysts and spores with four hours' exposure. Other researchers, however, have found the mixed oxidant process equivalent to free chlorine for inactivation of biofilm samples (Crayton, Camper and Warwood 1997).

Additional research is needed to improve the understanding of the chemistry of seemingly incompatible oxidants within the mixed oxidant reaction (taken from WHO 2004b, Chapter 3.3.6). Proponents of mixed oxidant disinfection rarely seem to define the product in detail. One such product occasionally marketed in New Zealand is called MIOX.

### 15.5.13 Membrane technologies

Membrane technology (also see Chapter 14: Treatment Processes, Filtration and Chapter 19, section 19.3: Individual supplies) includes processes such as nanofiltration, reverse osmosis and ultrafiltration. These technologies are receiving increased attention for the treatment of water. They do not achieve disinfection by chemical inactivation of the micro-organisms, but by physically removing them from the water. The efficiency with which smaller micro-organisms are removed depends on the characteristics of the membrane and the size and filterability of the cells or (oo)cysts. If membrane technologies were to be used as the sole disinfecting process, a membrane process ideally must be selected that would ensure virus removal. RO is claimed to be able to do that.

Microfiltration also removes micro-organisms, but being coarser, cannot be relied upon to remove a high proportion of micro-organisms smaller than the protozoa, ie, the bacteria and viruses.

When microbial growth that will foul the membrane is not a problem, chemical disinfectants are not required and the formation of disinfection by-products is not a concern. However, many waters may require the use of chemical disinfectants to control biofouling of the membranes. Disinfection by-products may be formed in these cases.

Like UV treatment, this physical means of disinfection does not provide a disinfecting residual. Depending on the technology used, and the pore size of the membrane, very high percentages of rejection of the natural organic matter from which disinfection by-products are formed, can be achieved. Post-disinfection to maintain a residual in these instances will not lead to significant disinfection by-product formation.

### 15.5.14 Sunlight (solar disinfection or SODIS)

Section 3.4 of WHO (2009) states:

Laboratory tests showed that at a water temperature of 50°C, only a quarter of the ultraviolet light required at 30°C is necessary to kill the same level of faecal coliforms. Householders should fill 1 to 2 litre clear, plastic polyethylene

terephthalate (PET) bottles with water, place them on their roofs for at least 6 h during the daytime and store the water in the bottles until it is actually consumed. Under cloudy conditions, the length of exposure must be increased; for simplicity, solar disinfection users are told to keep bottles on the roof for 1 sunny day or 2 days if cloudy. As suspended solids may block the ultraviolet radiation, water with high levels of turbidity (> 100 NTU) must undergo some process (filtration, flocculation or simple sedimentation) to reduce particulate prior to use.

Solar disinfection has been subject to rigorous testing, both in the laboratory and under field conditions, and evaluated for effectiveness and cost-effectiveness in preventing diarrhoeal disease. While such testing has included permanently mounted panels and other configurations (Kang, Roy and Balraj 2006), the solar disinfection bottle system has been particularly well documented. Testing in both the laboratory and the field has shown the approach to be effective against a variety of faecal pathogens (Wegelin et al 1994; Heaselgrave et al 2006) and in reducing diarrhoeal disease (Conroy et al 1996, 1999, 2001; Lijima et al 2001; Rose et al 2006). *Giardia* and *Cryptosporidium* have both shown susceptibility to sunlight (McGuigan et al 2006). A cost-effectiveness analysis reported that the mean cost of implementing the intervention in 13 countries, including hardware (new bottles) and programme costs, was US\$0.63 per person per year, just below the US\$0.66 cost attributed to the SWS and far less than the US\$3.03 for ceramic filters and US\$ 4.95 for flocculant-disinfectant sachets (Clasen et al 2007a).

The summary of the same WHO publication states:

Solar disinfection, which synergistically applies the biocidal action of heat and ultraviolet radiation, has also been shown to be effective, both microbiologically and in reducing diarrhoeal disease and cholera. Although continuous commercial systems are used in some settings, the approach that has gained the largest traction among low-income populations consists simply of filling clear plastic bottles with water and placing them on the roof to expose the water to sunlight for at least six hours. Like boiling, this method is fundamentally a behaviour change strategy more than a product and thus has little commercial potential. Accordingly, it is promoted exclusively by governments and NGOs. Despite these limitations, solar disinfection reported more than 2.1 million users as of the end of 2007. While the delivery strategy and low cost may overcome some of the disparities in uptake that are more likely to impact market-driven HWTS products, scaling up solar disinfection widely has thus far met challenges in acceptability and longer-term use, partly due to some resistance in gaining credibility among potential users, some inconvenience, its inability to deliver improvements in water aesthetics and its lack of aspirational appeal. These are, however, many of the same challenges that boiling has had to overcome.

Due to concerns of chemicals leaching from plastic bottles, a study by Asiimwe et al (2013) found that glass bottles are as effective as PET bottles for inactivating *E. coli*.

See also WHO (2011a). The efficacy of the process is dependent on oxygenation, sunlight intensity, exposure time, temperature, turbidity and size of water vessel (depth of water).

Because the pasteurising effect of elevated temperature is an important component of the disinfection process, it is suggested that the bottles be placed on a dark surface. See [www.sodis.ch](http://www.sodis.ch) for an extensive bibliography.

The WHO Guidelines (2004) state:

Where there is a concern about the quality of drinking-water in an emergency situation that cannot be addressed through central services, then the appropriateness of household-level treatment should be evaluated, including, for example:

- bringing water to a rolling boil and cooling before consumption
- adding sodium or calcium hypochlorite solution, such as household bleach, to a bucket of water, mixing thoroughly and allowing to stand for about 30 minutes prior to consumption; turbid water should be clarified by settling and/or filtration before disinfection
- vigorously shaking small volumes of water in a clean, transparent container, such as a soft drink bottle, for 20 seconds and exposing the container to sunlight for at least six hours
- applying products such as tablets or other dosing techniques to disinfect the water, with or without clarification by flocculation or filtration
- end-use units and devices for field treatment of drinking-water.

The inactivation of four *Salmonella* serovars was examined in sunlit and dark microcosms. First order decay was observed in sunlit microcosms; the time until 90 percent inactivation was of the order of 10 minutes. A significant shoulder, of the order of one hour in length, was observed in the freshwater microcosms during which concentrations were stable. Serovar Mdandaka decayed more slowly than other serovars in both seawater and freshwater. The serovars were extremely stable in the dark microcosms showing little to no decay over 53 days (Boehm et al 2012).

The effect of sunlight on viruses in water PET bottles was reported by Carratalà et al (2016). Good inactivation of MS2 virus was achieved with >6 log units for a fluence of 1.34 kJ/cm<sup>2</sup> (corresponding to the recommended six hours of sunlight) in Swiss tap water at 22°C. In the dark controls for only 2-log inactivation was observed after an equivalent exposure time. In contrast, no inactivation of the  $\phi$  X174 virus was observed after exposure to a fluence of 1.34 kJ/cm<sup>2</sup>. The inactivation rate constant did not vary statistically from zero and was the same as the inactivation rate constant in the dark experiments. For HAdVs about 3 log inactivation occurred at a fluence of 1.34 kJ/cm<sup>2</sup>. The inactivation rate constant for HAdV dark controls was similar to that observed under simulated sunlight and therefore exposure to light seems not to contribute significantly to the inactivation of HAdV during SODIS. For EV about 1.5 log inactivation was achieved after exposure to a fluence of 1.34 kJ/cm<sup>2</sup>. There was no significant inactivation observed for the dark controls. The authors conclude that SODIS application procedures recommended for bacterial inactivation do not apply to enteric viruses. However, removal of viruses during SODIS may still be substantial for reactive (oxygen) species-susceptible viruses (such as enteroviruses), especially if the water temperature is high and the organic matter content of the source water is low.

The potentially wide application of SODIS has led to studies which may enhance the process. McLaughlin et al (2016) found that adding copper wire to the PET bottle was



effective in inactivating *E. coli*, while earlier studies had shown that storing water overnight in copper pots eliminated a range of pathogenic bacteria (Sudha et al 2012). Sudha had also shown that copper pots were effective in eliminating rotavirus.

## 15.5.15 Heat

It is generally accepted that water that has been brought to a 'rolling' boil should be safe to drink, from a bacteriological, virological and protozoal point of view.

What is less well known is the effect of sub-boiling water. WHO (2015) is a Technical Brief "Boil Water" which includes a table summarising studies that have examined thermal inactivation in liquids at temperatures approaching 100°C. Bacteria are particularly sensitive to heat, and rapid kills – less than one minute per log (90 percent) reduction – are achieved at temperatures above 65°C. Viruses are inactivated at temperatures between 60°C and 65°C, but more slowly than bacteria. However, as shown for poliovirus and hepatitis A, as temperatures increase above 70°C, a greater than 5 log inactivation (99.999 percent reduction) is achieved in less than one minute. *Cryptosporidium parvum* oocysts are inactivated in less than one minute once temperatures exceed 70°C. The data for *Giardia* cysts are more limited, but inactivation at temperatures ranging from 50°C to 70°C has been reported.

## References

- Anderson C. 1991. Cholera epidemic traced to risk miscalculation. *Nature* 354: 255.
- ANSI/AWWA B300-10. *AWWA Standard for Hypochlorites* (10/16/2009).
- ANSI/AWWA B301-10. *AWWA Standard for Liquid Chlorine* (10/16/2009).
- ANSI/AWWA B305-06. *AWWA Standard for Anhydrous Ammonia*.
- ANSI/AWWA B306-07. *AWWA Standard for Liquid Ammonia*.
- ANSI/AWWA B303-10. *AWWA Standard for Sodium Chlorite*.
- ANSI/AWWA B200-12. *AWWA Standard for Sodium Chloride*.
- ANSI/AWWA C670-09. *AWWA Standard for Online Chlorine Analyser Operation and Maintenance*.
- ANSI/AWWA F110-12. *Standard for Ultraviolet Disinfection Systems for Drinking Water*.
- APHA, AWWA, WEF. 2005. *Standard Methods for the Examination of Water and Wastewater* (21st edition). Washington: American Public Health Association, American Water Works Association, Water Environment Federation.
- Armon R, Laot N, Shuval H, et al. 2000. Controlling biofilm formation by hydrogen peroxide and silver combined disinfectant. *Water Science and Technology* 42: 187.

Asiimwe JK, et al. 2013. Field comparison of solar water disinfection (SODIS) efficacy between glass and polyethylene terephthalate (PET) plastic bottles under sub-Saharan weather conditions. *Journal Water and Health* 11(4): 729–37.

AWWA. 2004. *Problem Organisms in Water: Identification and Treatment*. Manual of Water Supply Practices, AWWA Manual M7. Denver: American Water Works Association.

AWWA Manual. *M20 Water Chlorination/Chloramination Practices and Principles*. Denver CO: American Water Works Association.

AWWA Manual. *M56 Fundamentals and Control of Nitrification in Chloraminated Drinking Water Distribution Systems*. Denver CO: American Water Works Association.

AWWA C670-09. *Online Chlorine Analyzer Operation and Maintenance* (8/7/2009).

Bellar TA, Lichtenberg JJ, Kroner RC. 1974. The occurrence of organohalides in chlorinated drinking water. *J AWWA* 66: 703.

Boehm AB, Soetjipto C, Wang D. 2012. Solar inactivation of four *Salmonella* serovars in fresh and marine waters. *J Water & Health* 10(4): 504–10.

<https://doi.org/10.2166/wh.2012.084>.

Bolton JR. 2004. Fundamentals of ultraviolet treatment: terms and definitions do matter! *IUVA News* 6(3): 27. IUVA: 628 Cheriton Crescent, NW, Edmonton, AB, Canada T6R 2M5.

Bolton JR. 2000. Terms and definitions in ultraviolet disinfection. *Proceedings, Disinfection 2000: Disinfection of Wastes in the New Millennium*, 15–18 March. New Orleans, LA: Water Environment Federation (WEF).

Buhkari Z, Hargy TM, Bolton JR, et al. 1999. Medium-pressure UV for oocyst inactivation. *Journal AWWA* 91(3): 86–94.

Carratalà A, et al. 2016. Solar disinfection of viruses in polyethylene terephthalate bottles. *Applied and Environmental Microbiology* 82(1): 279–88.

Collette TW, Richardson SD, Thruston AD. 1994. Identification of bromohydrins in ozonated waters. *Applied Spectroscopy* 48(10): 1181–295.

Crayton C, Camper AK, Warwood B. 1997. Evaluation of mixed-oxidants for the disinfection and removal of biofilms from distribution systems. *Proceedings of the American Water Works Association Water Quality Technology Conference*. Denver, CO: American Water Works Association.

CRC. 2002. *Disinfection By-products and Health Effects*. Seminar and workshop conducted by the Cooperative Research Centre for Water Quality and Treatment and the Water Services Association of Australia. [www.waterquality.crc.org.au](http://www.waterquality.crc.org.au) or <http://www.waterra.com.au/publications/document-search/?download=31>.

Cushing RS, Mackey ED, Bolton JR, et al. 2001. Impacts of common water treatment chemicals on UV disinfection. *Proceedings of the AWWA Annual Conference and Exposition*, 17–21 June, Washington DC.

DEFRA. 2009. *Review of the Current Toxicological and Occurrence Information Available on Iodinated Disinfection By-Products*. WRc Ref: DEFRA 7883.03 DWI Ref: 70/2/233.

104 pp. [http://dwi.defra.gov.uk/research/completed-research/reports/DWI70\\_2\\_233.pdf](http://dwi.defra.gov.uk/research/completed-research/reports/DWI70_2_233.pdf).

DEFRA. 2017. *Formation of DBPs during Booster Chlorination*. Defra Project WT1291; DWI Project 70/2/297. Department: Water, Environment and Energy. 109 pp. <http://dwi.defra.gov.uk/research/completed-research/reports/DWI70-2-297.pdf>.

DVGW W294. *Deutsche Vereinigung des Gas- und Wasserfaches (German Association for Gas and Water)*. This is the German standard for UV disinfection.

DWI. 2005. *DWI Guidance on Calibration and AQC for Residual Chlorine Measurements*. Drinking Water Inspectorate, DEFRA, London. 8 pp. <http://dwi.defra.gov.uk/stakeholders/guidance-and-codes-of-practice/> or <http://dwi.defra.gov.uk/stakeholders/guidance-and-codes-of-practice/AQC%20for%20residual%20chlorine%20measurements.pdf>.

DWI. 2007. *Chlorination Disinfection By-products and Risk of Congenital Anomalies in England and Wales*. 38 pp. [http://dwi.defra.gov.uk/research/completed-research/reports/DWI70-2-161\\_Chlorination.pdf](http://dwi.defra.gov.uk/research/completed-research/reports/DWI70-2-161_Chlorination.pdf).

DWI. 2010. *Guidance on the Use of Ultraviolet Irradiation for the Disinfection of Public Water Supplies*. 16 pp. London: Drinking Water Inspectorate, DEFRA. <http://dwi.defra.gov.uk/stakeholders/guidance-and-codes-of-practice/uvirradiation.pdf>.

Drinking Water Inspectorate (DWI). 2011. *List of Approved Products for Use in Public Water Supply in the United Kingdom*. London: Department for Environment, Food and Rural Affairs. See [www.dwi.gov.uk](http://www.dwi.gov.uk) or <http://dwi.defra.gov.uk/drinking-water-products/approved-products/soslistcurrent.pdf>.

DWI. 2015. *Risk Assessment of VTEC Infections in English and Welsh Drinking Water*. Contract DWI/70/2/256. 82 pp. <http://dwi.defra.gov.uk/research/completed-research/reports/DWI70-2-256.pdf>.

DWI. 2015a. *Effect of UV on the Chemical Composition of Water including DBP Formation: Final Report*. Report No. Defra 10459.04. 137 pp. <http://dwi.defra.gov.uk/research/completed-research/reports/DWI70-2-300.pdf>.

DWI. 2016. *Identification of High Risk Sites for Iodinated DBP Formation*. Project No.: DWI 70/2/291. 50 pp. <http://dwi.defra.gov.uk/research/completed-research/reports/DWI70-2-291.pdf>.

DWI. 2016a. *Comparison of Private Water Supply and Public Water Supply Ultraviolet (UV) Systems: Final Report*. Report Reference: DEFRA10932.05. 177 pp. <http://dwi.defra.gov.uk/research/completed-research/reports/DWI70-2-306.pdf>.

DWI. 2016b. *Guidance on the Use of Ultraviolet (UV) Irradiation for the Disinfection of Public Water Supplies*. 17 pp. <http://dwi.defra.gov.uk/stakeholders/guidance-and-codes-of-practice/uv-irradiation.pdf>.

DWI. 2018. *Potential for Formation of Disinfection By-products from Advanced Oxidation Processes*. Report DWI 12852.02. 260 pp. <http://dwi.defra.gov.uk/research/completed-research/reports/DWI70-2-317.pdf>.

- EPA Ireland. 2011. *Water Treatment Manual: Disinfection*. 200 pp. Environmental Protection Agency, Office of Environmental Enforcement.  
[http://www.epa.ie/pubs/advice/drinkingwater/Disinfection2\\_web.pdf](http://www.epa.ie/pubs/advice/drinkingwater/Disinfection2_web.pdf).
- Goslan, et al. 2010. A comparison of disinfection by-products found in chlorinated and chloraminated drinking waters in Scotland. *Water Research* 42(18): 4698–706.
- Harp DL, Klein RL, Schoonover DJ. 1981. Spectrophotometric determination of chlorine dioxide. *JAWWA* 73(7): 387–8.
- Health Canada, Communications and Consultation Directorate. 1995. *A National Survey of Chlorinated Disinfection By-Products in Canadian Drinking Water*. Copyright Minister of Supply and Services Canada. See: [http://recherche-search.gc.ca/s\\_r?t3mpl1t34d=1&s5t34d=health&l7c1l3=eng&S\\_08D4T.1ct57n=search&S\\_S20RCH.p1r1m3tr5cF53lds=hcyar%2Chcsubject%2Chctype%2Chcsource%2Chccollection&S\\_S20RCH.p1r1m3tr5cS7rt=ReverseAlphabetical&S\\_08D4T.s3rv5c3=basic&S\\_m5m3typ3.sp3c5f53r=INDEX&S\\_m5m3typ3.t3xt6p3r1t7r=OR&S\\_m5m3typ3.v1l93=html%2Fhtml&S\\_S20RCH.d7csP3rP1g3=20&S\\_F8LLT2XT=A+National+Survey+of+Chlorinated+Disinfection+By-Products+in+Canadian+Drinking+Water&submit=Search&S\\_S20RCH.l1ng91g3=eng](http://recherche-search.gc.ca/s_r?t3mpl1t34d=1&s5t34d=health&l7c1l3=eng&S_08D4T.1ct57n=search&S_S20RCH.p1r1m3tr5cF53lds=hcyar%2Chcsubject%2Chctype%2Chcsource%2Chccollection&S_S20RCH.p1r1m3tr5cS7rt=ReverseAlphabetical&S_08D4T.s3rv5c3=basic&S_m5m3typ3.sp3c5f53r=INDEX&S_m5m3typ3.t3xt6p3r1t7r=OR&S_m5m3typ3.v1l93=html%2Fhtml&S_S20RCH.d7csP3rP1g3=20&S_F8LLT2XT=A+National+Survey+of+Chlorinated+Disinfection+By-Products+in+Canadian+Drinking+Water&submit=Search&S_S20RCH.l1ng91g3=eng).
- Hoff JC. 1986. *Inactivation of Microbial Agents by Chemical Disinfectants*. Report EPA/600/2-86/067. Cincinnati, OH: Water Engineering Research Laboratory, USEPA.
- IARC. 1991. Chlorinated drinking-water; chlorination by-products; some other halogenated compounds; cobalt and cobalt compounds. *IARC Monographs on the Evaluation of Carcinogenic Risks to Humans* 52.  
<http://monographs.iarc.fr/ENG/Classification/index.php>.
- IPCS. 2000. Disinfectants and disinfectant by-products. *Environmental Health Criteria* 216. A WHO Task Group Report.  
<http://www.inchem.org/documents/ehc/ehc/ehc216.htm>.
- IUPAC. 1997. *Compendium of Chemical Terminology* (2nd edition) (The Gold Book). AD McNaught, A Wilson. Oxford: Blackwell Scientific Publications.  
<http://goldbook.iupac.org/H02727.html>.
- Jacangelo JG, Patania NL, Trussell RR, et al. 2002. *Inactivation of Waterborne Emerging Pathogens by Selected Disinfectants*. Denver, AWWA Research Foundation and the American Water Works Association 1–145.
- Kimura SY, et al. 2019. The DBP exposome: Development of a new method to simultaneously quantify priority disinfection by-products and comprehensively identify unknowns. *Water Research* 148: 324–33. doi: 10.1016/j.watres.2018.10.057.
- Krasner SW. 1999. Chemistry of disinfection by-product formation (chapter 3). In PC Singer (ed) *Formation and Control of Disinfection By-products in Drinking Water*. Denver CO: American Water Works Association.
- McGuire MJ, Pearthree MJ, Blute NK, et al. 2004. *Tucson Nitrification Control Pilot Study: A significant advance in the state-of-the-art of implementing chloramines in a desert environment*. Mesa, AZ: 77th Annual Conference of the Arizona Water & Pollution Control Association.

McLaughlin, et al. 2016. Inactivation of *E. coli* by copper and silver wire in the presence of synthetic sunlight for safe drinking water. *J Water, Sanitation and Hygiene for Development* 6(4).

[https://www.researchgate.net/publication/310472461\\_Inactivation\\_of\\_E\\_Coli\\_by\\_copper\\_and\\_silver\\_wire\\_in\\_the\\_presence\\_of\\_synthetic\\_sunlight\\_for\\_safe\\_drinking\\_water](https://www.researchgate.net/publication/310472461_Inactivation_of_E_Coli_by_copper_and_silver_wire_in_the_presence_of_synthetic_sunlight_for_safe_drinking_water).

The New Zealand Ministry of Health's Guides for drinking-water supplies can be accessed as Word documents on the Ministry of Health website:

<http://www.health.govt.nz/water> then select publications and Water Safety Plans.

Ministry of Health. *Public Health Risk Management Plan Guide PHRMP Ref: P7.1. Treatment Processes – Chlorine Disinfection*. Wellington: Ministry of Health.

Ministry of Health. *Public Health Risk Management Plan Guide PHRMP Ref: P7.2. Treatment Processes – Chlorine Dioxide Disinfection*. Wellington: Ministry of Health.

Ministry of Health. *Public Health Risk Management Plan Guide PHRMP Ref: P7.3. Treatment Processes – Ozone Disinfection*. Wellington: Ministry of Health.

Ministry of Health. *Public Health Risk Management Plan Guide PHRMP Ref: P7.4. Treatment Processes – Ultraviolet Irradiation Disinfection*. Wellington: Ministry of Health.

Ministry of Health. *Public Health Risk Management Plan Guide PHRMP Ref: P8.1. Treatment Processes – pH Adjustment*. Wellington: Ministry of Health.

Ministry of Health. *Public Health Risk Management Plan Guide PHRMP Ref: P11. Treatment Processes – Plant Construction and Operation*. Wellington: Ministry of Health.

Ministry of Health. 2005. *Drinking-water Standards for New Zealand 2005, revised 2008*. Wellington: Ministry of Health.

Myllycangas T. 2004. *Prevention of Bromine-Containing Disinfection By-products During Drinking Water Treatment*. National Public Health Institute, Department of Environmental Health Laboratory of Chemistry, Kuopio, Finland and University of Kuopio Department of Environmental Sciences. 161 pp.  
[www.ktl.fi/attachments/suomi/julkaisut/julkaisusarja\\_a/2004a3.pdf](http://www.ktl.fi/attachments/suomi/julkaisut/julkaisusarja_a/2004a3.pdf).

ÖNORM. 2001. *Plants for the Disinfection of Water Using Ultraviolet Radiation: Requirements and testing*. ÖNORM 5873-1. Osterreichisches Normungsinstitut, A-1021 Wien. Available at: <http://www.on-norm.at>.

Patil, et al. 2013. Comparative study of disinfectants for use in low-cost gravity driven household water purifiers. *Jnl of Water and Health* 11(3): 443–56.

Pyle BH, Boadaway SC, McFeters GA. 1992. Efficacy of copper and silver ions with iodine in the inactivation of *Pseudomonas cepacia*. *Journal of Applied Bacteriology* 72: 71.

Rechhow DA, Singer PC. 1990. Chlorination by-products in drinking waters: from formation potentials to finished waters concentrations. *J AWWA* 82: 173.

Rechhow, et al. 2010. Effect of UV treatment on DBP formation. *JAWWA* 102(6): 100–13.

Regli S, Berger P, Macler B, et al. 1993. Proposed decision tree for management of risks in drinking water: Consideration for health and socioeconomic factors. In GF Craun (ed)

*Safety of Water Disinfection: Balancing chemical and microbial risks*. ILSI Press, Washington DC.

Richardson SD. 2005. New disinfection by-product issues: emerging DBPs and alternative routes of exposure. *Global NEST Journal* 7(1): 43–60.

[http://gnest.org/Journal/Vol7\\_No1/7\\_1\\_Richardson-320\\_43-60.pdf](http://gnest.org/Journal/Vol7_No1/7_1_Richardson-320_43-60.pdf).

Rook JJ. 1974. Formation of haloforms during chlorination of natural waters. *Water Treat Exam* 23(2): 234.

Simmons, et al. 2002. Development of a research strategy for integrated technology-based toxicological and chemical evaluation of complex mixtures of drinking water disinfection by-products. *Environmental Health Perspectives* 110(Suppl 6): 1013–24. See

<http://www.ncbi.nlm.nih.gov/pmc/articles/PMC1241286/>.

Stevenson DG. 1995. The design of disinfection contact tanks. *J Chart Inst Water & Env Mgmt* 9(2): 146–52.

Stevenson D, Zipfel H. 2018. UV peroxide – a New Zealand approach. Paper to Water NZ 2018 Conference, 14 pp.

[https://www.waternz.org.nz/Attachment?Action=Download&Attachment\\_id=3373](https://www.waternz.org.nz/Attachment?Action=Download&Attachment_id=3373).

Sudha, et al. 2012. Storing drinking-water in copper pots kills contaminating diarrhoeagenic bacteria. *J Health Population and Nutrition* 30(1): 17–21.

[https://www.researchgate.net/publication/224822827\\_Storing\\_Drinking-water\\_in\\_Copper\\_pots\\_Kills\\_Contaminating\\_Diarrhoeagenic\\_Bacteria](https://www.researchgate.net/publication/224822827_Storing_Drinking-water_in_Copper_pots_Kills_Contaminating_Diarrhoeagenic_Bacteria).

USAPHC. March 2006, updated January 2011. *Iodine Disinfection in the Use of Individual Water Purification Devices*. Technical Information Paper #-31-005-0211, prepared by: Steven H Clarke, Environmental Engineer. US Army Public Health Command. 15 pp.

<http://phc.amedd.army.mil/PHC%20Resource%20Library/Iodine%20Disinfection%20in%20the%20Use%20of%20Individual%20Water%20Purification%20Devices.pdf>.

USEPA. 1991. *Guidance Manual for Compliance with the Filtration and Disinfection Requirements for Public Water Systems Using Surface Water*. (Also known as SWTR.) 580 pp. <http://water.epa.gov/lawsregs/rulesregs/sdwa/swtr/index.cfm>.

USEPA. 1999. *Alternative Disinfectants and Oxidants, Guidance Manual*. EPA 815-R99-014. 346 pp. <https://www.epa.gov/dwreginfo/guidance-manuals-surface-water-treatment-rules>.

USEPA. 1999a. *Disinfection Profiling and Benchmarking Guidance Manual*. EPA 815-R-99-013. 192 pp.

<https://nepis.epa.gov/Exe/ZyPDF.cgi?Dockey=20002249.txt>.

USEPA. 2001. *Controlling Disinfection By-Products and Microbial Contaminants in Drinking Water*. Office of Research and Development. Document EPA/600-R-01-110. 330 pp. See: <http://www.epa.gov/nrmrl/pubs/600r01110.html>.

USEPA. 2003. *Small Drinking Water Systems Handbook*. A guide to 'packaged' filtration and disinfection technologies with remote monitoring and control tools. United States Environmental Protection Agency, Office of Research and Development, Water Supply

and Water Resources Division. EPA/600/R-03/041. 73 pp. Available at:  
<http://www.epa.gov/nrmrl/pubs/600r03041.html>.

USEPA. 2003a. Long term 2 enhanced surface water treatment rule: proposed rule (draft). *National Primary Drinking Water Regulations*, 40 CFR Parts 141, 142, 11 August.  
[www.epa.gov/safewater/lt2/pdfs/fr\\_lt2\\_full.pdf](http://www.epa.gov/safewater/lt2/pdfs/fr_lt2_full.pdf) – see USEPA (2006) for Final Rule.

USEPA. 2003b. Long term 2 enhanced surface water treatment rule: proposed rule (LT2ESWTR), *Toolbox Guidance Manual*, Chapter 11: Ozone, draft.  
[www.epa.gov/safewater/lt2/pdfs/guide\\_lt2\\_toolbox.pdf](http://www.epa.gov/safewater/lt2/pdfs/guide_lt2_toolbox.pdf). NOTE see USEPA (2009), but still called a 'draft'.

USEPA. 2003c. Long term 2 enhanced surface water treatment rule: Proposed rule (LT2ESWTR). *Ultraviolet Disinfection Guidance Manual* (draft). EPA 815-D-03-007.  
[www.epa.gov/safewater/lt2/pdfs/guide\\_lt2\\_uvguidance\\_draft.pdf](http://www.epa.gov/safewater/lt2/pdfs/guide_lt2_uvguidance_draft.pdf) – see USEPA (2006a) for final version.

USEPA. 2003d. *LT1ESWTR Disinfection Profiling and Benchmarking Technical Guidance Manual*. EPA 816-R-03-004. 210 pp. Available at:  
<http://www.epa.gov/safewater/mdbp/pdf/profile/lt1profiling.pdf> or go to  
<http://water.epa.gov/lawsregs/rulesregs/sdwa/mdbp/lt1/lt1eswtr.cfm>.

USEPA. 2005. *Determination of Chlorine Dioxide and Chlorite Ion in Drinking Water using Lissamine Green B and Horseradish Peroxidase with Detection by Visible Spectrophotometry*. Method 327.0. 30 pp.  
[http://permanent.access.gpo.gov/lps92531/met327\\_0\\_1\\_1.pdf](http://permanent.access.gpo.gov/lps92531/met327_0_1_1.pdf).

USEPA. 2006. *National Primary Drinking Water Regulations: Long term 2 enhanced surface water treatment rule: final rule*. (LT2ESWTR). Federal Register Part II, 40 CFR Parts 9, 141 and 142. Washington: National Archives and Records Administration. See  
<http://www.epa.gov/fedrgstr/EPA-WATER/2006/January/Day-05/w04a.pdf>  
<http://www.epa.gov/fedrgstr/EPA-WATER/2006/January/Day-05/w04b.pdf>  
<http://www.epa.gov/fedrgstr/EPA-WATER/2006/January/Day-05/w04c.pdf>.

USEPA. 2006a. *Ultraviolet Disinfection Guidance Manual for the Final Long Term 2 Enhanced Surface Water Treatment Rule*. EPA 815-R-06-007. Available at:  
[www.epa.gov/safewater/disinfection/lt2/pdfs/guide\\_lt2\\_uvguidance.pdf](http://www.epa.gov/safewater/disinfection/lt2/pdfs/guide_lt2_uvguidance.pdf).

USEPA. 2006b. *Initial Distribution System Evaluation Guidance Manual for the Final Stage 2 Disinfectants and Disinfection Byproducts Rule*. Several manuals accessible via:  
[http://water.epa.gov/lawsregs/rulesregs/sdwa/stage2/compliance\\_idse.cfm](http://water.epa.gov/lawsregs/rulesregs/sdwa/stage2/compliance_idse.cfm).

USEPA. 2007. *Information about Chloramine in Drinking Water*. US Environmental Protection Agency.  
[http://water.epa.gov/lawsregs/rulesregs/sdwa/mdbp/chloramines\\_index.cfm](http://water.epa.gov/lawsregs/rulesregs/sdwa/mdbp/chloramines_index.cfm).

USEPA. 2007a. *Complying with the Stage 2 Disinfectant and Disinfection Byproducts Rule: Small Entity Compliance Guide*. EPA 815-R-07-014. 57 pp.  
[http://www.epa.gov/ogwdw/disinfection/stage2/pdfs/guide\\_st2\\_stepguide\\_small\\_entitycomplianceguide.pdf](http://www.epa.gov/ogwdw/disinfection/stage2/pdfs/guide_st2_stepguide_small_entitycomplianceguide.pdf).

USEPA. 2009. *Long Term 2 Enhanced Surface Water Treatment Rule: Toolbox guidance manual*. Review Draft. EPA-815-D-09-001. 340 pp. Washington: United States Environmental Protection Agency. Go into

<http://www.epa.gov/safewater/disinfection/lt2/> and then enter: toolbox guidance manual review draft in the 'search' box. See USEPA (2010a) for Final.

USEPA. 2010. *Stage 2 Disinfectants and Disinfection Byproducts Rule, Consecutive Systems Guidance Manual*. EPA 815-R-09-017. 74 pp.

[http://water.epa.gov/lawsregs/rulesregs/sdwa/stage2/upload/guide\\_stage2\\_consecutive\\_systems\\_mar2010\\_v3.pdf](http://water.epa.gov/lawsregs/rulesregs/sdwa/stage2/upload/guide_stage2_consecutive_systems_mar2010_v3.pdf).

USEPA. 2010a. *Long Term 2 Enhanced Surface Water Treatment Rule, Toolbox Guidance Manual*. EPA-815-R-09-016. 375 pp.

[http://www.epa.gov/safewater/disinfection/lt2/pdfs/guide\\_lt2\\_toolboxguidance\\_manual.pdf](http://www.epa.gov/safewater/disinfection/lt2/pdfs/guide_lt2_toolboxguidance_manual.pdf).

UWRAA. 1990. *Chloramination of Water Supplies*. PM Thomas (ed). Melbourne: Urban Water Research Association of Australia, Research Report No. 15.

Venczel LV, et al. 1997. Inactivation of *Cryptosporidium parvum* oocysts and *Clostridium perfringens* spores by a mixed-oxidant disinfectant and by free chlorine. *Applied and Environmental Microbiology* 63: 1598–601.

Water Research Foundation. 2009. *Mammalian Cell Cytotoxicity and Genotoxicity of Disinfection By-Products*. Project 3089. Summary in

[http://prod2010.waterrf.org/ExecutiveSummaryLibrary/91249\\_3089\\_profile.pdf](http://prod2010.waterrf.org/ExecutiveSummaryLibrary/91249_3089_profile.pdf).

Water UK. 2010. *Water Treatment – Disinfection. Technical Guidance Note 8*. 4 pp.

<http://www.water.org.uk/home/policy/publications/archive/drinking-water/principles-of-water-supply-hygiene>.

White GC. 1999. *Handbook of Chlorination and Alternative Disinfectants* (4th edition). Wiley & Sons Inc.

WHO. 2004. *Guidelines for Drinking-water Quality 2004* (3rd edition). Geneva: World Health Organization. Available at:

[www.who.int/water\\_sanitation\\_health/dwq/gdwq3/en/print.html](http://www.who.int/water_sanitation_health/dwq/gdwq3/en/print.html) see also the addenda. Edited 2006.

WHO. 2004a. *Pathogenic Mycobacteria in Water: A guide to public health consequences, monitoring and management*. 237 pp. Published by IWA Publishing on behalf of the World Health Organization, ISBN 92-4-156259-5 (WHO), ISBN 1-84339-059-0 (IWA Publishing). See:

[http://www.who.int/water\\_sanitation\\_health/emerging/pathmycobact/en/index.html](http://www.who.int/water_sanitation_health/emerging/pathmycobact/en/index.html).

WHO. 2004b. *Water Treatment and Pathogen Control: Process efficiency in achieving safe drinking water*. MW Le Chevallier, K-K Au. IWA Publishing. 136 pp. Available at:

[www.who.int/water\\_sanitation\\_health/publications/en/index.html](http://www.who.int/water_sanitation_health/publications/en/index.html).

WHO. 2005. *Preventing Travellers' Diarrhoea: How to make drinking-water safe*.

WHO/SDE/WSH/05.07. 7 pp. Available at:

[http://www.who.int/water\\_sanitation\\_health/hygiene/envsan/sdwtravel.pdf](http://www.who.int/water_sanitation_health/hygiene/envsan/sdwtravel.pdf).

WHO. 2009. *Scaling up Household Water Treatment among Low-income Populations*.

WHO/HSE/WSH/09.02. Geneva: World Health Organization. 84 pp.

[http://www.who.int/household\\_water/research/household\\_water\\_treatment/en/index.html](http://www.who.int/household_water/research/household_water_treatment/en/index.html).



WHO. 2011. *Guidelines for Drinking-water Quality* (4th edition). Geneva: World Health Organization. Available at:

[http://www.who.int/water\\_sanitation\\_health/publications/2011/dwq\\_guidelines/en/index.html](http://www.who.int/water_sanitation_health/publications/2011/dwq_guidelines/en/index.html).

WHO. 2011a. *Evaluating Household Water Treatment Options: Health-based targets and microbiological performance specifications*. 68 pp.

[http://www.who.int/water\\_sanitation\\_health/publications/2011/evaluating\\_water\\_treatment.pdf](http://www.who.int/water_sanitation_health/publications/2011/evaluating_water_treatment.pdf).

WHO. 2015. *Boil Water*. Technical Brief. WHO/FWC/WSH/15.02. 2 pp.

[http://www.who.int/water\\_sanitation\\_health/dwq/Boiling\\_water\\_01\\_15.pdf?ua=1](http://www.who.int/water_sanitation_health/dwq/Boiling_water_01_15.pdf?ua=1).

WHO. 2017. *Guidelines for Drinking-water Quality: Fourth edition incorporating the first Addendum*. Geneva: World Health Organization. 631 pp.

[http://www.who.int/water\\_sanitation\\_health/publications/drinking-water-quality-guidelines-4-including-1st-addendum/en/](http://www.who.int/water_sanitation_health/publications/drinking-water-quality-guidelines-4-including-1st-addendum/en/).

WHO. 2018. *Alternative Drinking-water Disinfectants as a Drinking-water Disinfectant*.

[http://www.who.int/water\\_sanitation\\_health/publications/alternative-disinfectants/en/](http://www.who.int/water_sanitation_health/publications/alternative-disinfectants/en/).

WRF. 2015. *Guidance for Implementing Action Spectra Correction with Medium Pressure UV Disinfection*. Water Research Foundation, US Environmental Protection Agency, American Water Works Association. 150 pp.

<http://waterrf.org/PublicReportLibrary/4376.pdf>.

WRF. 2016. *UV System Validation by Lagrangian Actinometry Using Dyed Microspheres*. Project #4217 (Summary). 5 pp.

[http://www.waterrf.org/ExecutiveSummaryLibrary/4217\\_ProjectSummary.pdf](http://www.waterrf.org/ExecutiveSummaryLibrary/4217_ProjectSummary.pdf).

WRF. 2016a. *Advanced Techniques for Monitoring Changes in NOM and Controlling DBPs under Dynamic Weather Conditions*. [Project #4422]. Water Research Foundation.

<http://www.waterrf.org/Pages/Projects.aspx?PID=4422>.

WRF. 2016b. *Effect of Ozone Dissolution on Bromate Formation, Disinfection Credit, and Operating Cost – Project 4588*. Water Research Foundation. 111 pp.

<http://www.waterrf.org/Pages/Projects.aspx?PID=4588>.

WRF. 2016c. *Fate of Non-Regulated Disinfection By-products in Distribution Systems*.

Web Report #4242. 240 pp. Water Research Foundation (US) and Drinking Water Inspectorate (UK). <http://www.waterrf.org/PublicReportLibrary/4242.pdf>.

# Chapter 16: The distribution system

## Contents

|                        |  |           |
|------------------------|--|-----------|
| <b>16.1</b>            | <b>Introduction</b>  | <b>2</b>  |
| 16.1.1                 | Critical points in a distribution system                               | 3         |
| <b>16.2</b>            | <b>Components of a distribution system</b>                             | <b>5</b>  |
| 16.2.1                 | Service reservoirs   | 6         |
| 16.2.2                 | Distribution network   | 7         |
| 16.2.3                 | Pump stations  | 8         |
| 16.2.4                 | System monitoring and control  | 8         |
| 16.2.5                 | Design issues affecting water quality                                  | 9         |
| 16.2.6                 | Permeation, leaching, intrusion and pressure drop                      | 11        |
| <b>16.3</b>            | <b>Operations and maintenance</b>                                      | <b>18</b> |
| 16.3.1                 | Service reservoir operation  | 18        |
| 16.3.2                 | Reticulation operation   | 20        |
| 16.3.3                 | Maintenance of disinfection residual                                   | 29        |
| 16.3.4                 | Barriers against recontamination during maintenance                    | 30        |
| <b>16.4</b>            | <b>Aesthetic considerations</b>  | <b>35</b> |
| 16.4.1                 | Wholesomeness  | 35        |
| 16.4.2                 | Consumer complaints  | 40        |
|                        | <b>References</b>  | <b>41</b> |
| <b>List of figures</b> |  |           |
| Figure 16.1:           | Typical reticulation system  | 4         |
| Figure 16.2:           | Reservoir short-circuiting: severe (left) vs moderate short-circuiting | 7         |
| Figure 16.3:           | Fire hydrant standpipe being used to flush a water main                | 22        |
| Figure 16.4:           | Commissioning a backflow prevention device                             | 24        |
| Figure 16.5:           | Example of corroded water pipe   | 37        |
| Figure 16.6:           | Structure of a biofilm   | 40        |

# 16.1 Introduction

The introduction in WHO (Water Safety in Distribution Systems 2014) includes:

The integrity of well managed distribution systems is one of the most important barriers that protect drinking-water from contamination. However, management of distribution systems often receives too little attention. Distribution systems can incorrectly be viewed as passive systems with the only requirement being to transport drinking-water from the outlets of treatment plants to consumers.

There is extensive evidence that inadequate management of drinking-water distribution systems has led to outbreaks of illness in both developed and developing countries. The causes of these outbreaks and the range of chemical and microbial hazards involved are diverse. Between 1981 and 2010 in the USA, 57 outbreaks were associated with distribution system faults, leading to 9,000 cases of illness. The most common faults were cross-connections and back-siphonage; other faults included burst or leaking water mains, contamination during storage, poor practices during water main repair and installation of new water mains, pressure fluctuations and leaching from pipework; a significant proportion of faults are unknown. Elsewhere, outbreaks of illness have been associated with low water pressure and intermittent supply.

The most common causes of illness were enteric pathogens, including bacteria (*Salmonella*, *Campylobacter*, *Shigella*, *Escherichia coli* O157), protozoa (*Cryptosporidium*, *Giardia*) and viruses (norovirus). Chemicals, including copper, chlorine and lead, were associated with eight outbreaks (14 percent).

Outbreaks are the most noticeable outcome of distribution system failures, but represent only a small fraction of contamination events. Cross-connections, leaks and water main breaks and transient low water pressures are common events; although most do not cause reported outbreaks, it is likely that some could cause sporadic cases of illness that go undetected.

The transmission of water from the source or water treatment plant to the various consumers is usually done in two stages, distribution and reticulation. The former term is generally used to describe the system of bigger (or trunk) mains, reservoirs and, in some situations, pumping systems. In bigger systems such as in cities, the distribution function is well-defined and often operated separately. In large systems or where water is delivered to separate water suppliers, the initial delivery can be through bulk or trunk mains. The term reticulation is normally used to describe the street mains and connections to properties. However, use of these terms does tend to be interchangeable.

The distribution system is designed to:

- reliably distribute bulk water supplies to the suburbs, or supply points
- provide water at the correct elevation and/or pressure
- buffer the diurnal peaks in demand from the consumers
- maintain the water quality.

To achieve these objectives, particular combinations of reservoir storage, ring mains and pumping arrangements are used, depending upon the system topography and size.

A distribution system may also be made up of distribution zones. A distribution zone is a part of the distribution system in which all consumers receive drinking-water of identical quality, from the same or similar sources, with the same treatment and usually at the same pressure and is usually clearly separated from other parts of the network, generally by location, but in some cases by the layout or composition of the pipe network. In these Guidelines the term distribution system is used to include specific zones.

## 16.1.1 Critical points in a distribution system

Critical points are those points where procedures for equipment failure would lead to a public health hazard. Specific critical points are discussed in this chapter to highlight and differentiate the types of risk that are present in a distribution system. There are two types of critical points in the distribution system, those critical to continuity of supply and those critical to water contamination.

Water contamination is an obvious and direct risk to public health. It can occur directly by intrusion of contaminants into the system or by chemical reactions within the system (such as chemical reactions with the pipe structure). The contamination of water within the distribution system is discussed in detail in this chapter. Procedures for dealing with mains installation and repair are discussed in section 16.3.4.

Supply loss is also a critical point for public health, but is not the subject of these Guidelines. For the initial time (say several hours), the risks to the community are not those of thirst, they are those of fire fighting, minimal interruptions to industry, inadequacy of water for flushing away sewage, and for personal hygiene. The factors that could lead to supply loss include:

- loss of source water supply
- treatment failure
- water main failure
- service reservoir valve operation: inlet fails to open, drain fails to close
- water contamination, meaning supply must be stopped.

Emergency storage is required in order to continue supply when the inlet main is broken, during upstream system maintenance, or during some other loss of supply situation.

In practice, most supply losses involve a dual failure: a mechanical/electrical defect or human error that occurs **and** an alarm system that fails to provide warning in time to take corrective action. Therefore the alarm system needs regular testing and valves need regular working and testing, and staff needs regular training. Situations that can lead to loss of supply should be addressed in the water safety plan (WSP – formerly known as a public health risk management plan, PHRMP) or other appropriate manual.

**Figure 16.1: Typical reticulation system**

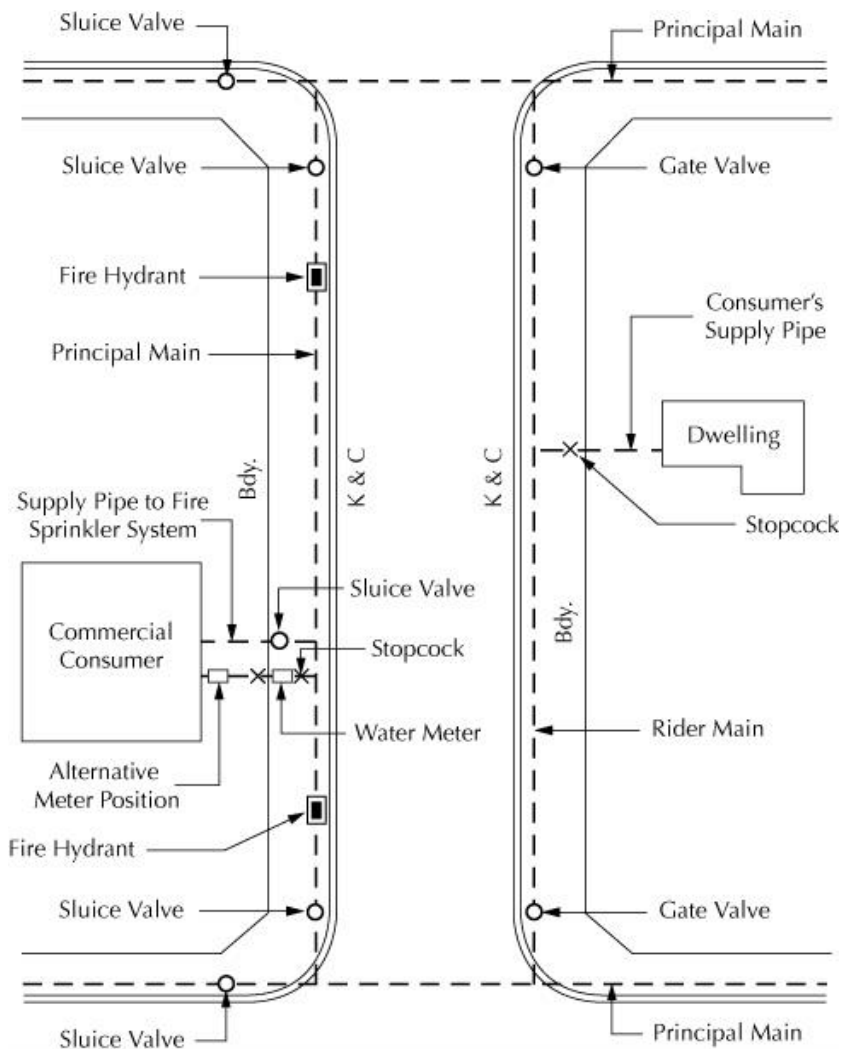

Risk management issues related to the distribution system are discussed in the:

- MoH Public Health Risk Management Plan Guide PHRMP Ref: P2: Treatment Processes – Water Transmission. Ministry of Health, Wellington.
- MoH Public Health Risk Management Plan Guide PHRMP Ref: P10: Treatment Processes – Pump Operation. Ministry of Health, Wellington.
- MoH Public Health Risk Management Plan Guide PHRMP Ref: D1: Distribution System – Post-Treatment Storage. Ministry of Health, Wellington.
- MoH Public Health Risk Management Plan Guide PHRMP Ref: D2.1: Distribution System – Construction Materials. Ministry of Health, Wellington.
- MoH Public Health Risk Management Plan Guide PHRMP Ref: D2.2: Distribution System – System Pressure. Ministry of Health, Wellington.
- MoH Public Health Risk Management Plan Guide PHRMP Ref: D2.3: Distribution System – Operation. Ministry of Health, Wellington.
- MoH Public Health Risk Management Plan Guide PHRMP Ref: D2.4: Distribution System – Backflow Prevention. Ministry of Health, Wellington.

WHO (2004) produced an excellent publication entitled *Safe Piped Water: Managing Microbial Water Quality in Distribution Systems*. This publication is available on the internet at [http://www.who.int/water\\_sanitation\\_health/dwq/924156251X/en/](http://www.who.int/water_sanitation_health/dwq/924156251X/en/) and then select the chapter. The chapters are titled:

- Contents, foreword, acknowledgements, acronyms and abbreviations [pdf 132kb]
- The microbiology of piped distribution systems and public health [pdf 119kb]
- Minimising potential for changes in microbial quality of treated water [pdf 256kb]
- Design and operation of distribution networks [pdf 157kb]
- Maintenance and survey of distribution systems [pdf 119kb]
- Precautions during construction and repairs [pdf 88kb]
- Small animals in drinking-water distribution systems [pdf 291kb]
- Risk management for distribution systems [pdf 182kb]
- Index [pdf 56kb].

USEPA (2006a) discusses in some detail several indicators and procedures that may be useful for assessing the quality of drinking water within potable water distribution systems. USEPA (2006b) discusses inorganic contamination in potable water distribution systems.

Water UK (2010) includes seven Technical Guidance Notes related to issues concerning the distribution system.

WHO (2011b) discusses issues related to water quality in buildings.

See <http://www.awwa.org/files/Resources/Standards/StandardsSpreadsheet.xls> for a list of AWWA Standards, many of which cover aspects of distribution systems. They have a large range of technical manuals covering distribution practices too ([www.awwa.org](http://www.awwa.org)).

## 16.2 Components of a distribution system

The general components of a water distribution system and their influence on water quality are described in this section. A more detailed description of the components themselves can be found in other Ministry of Health resources such as the Water Assessor Training Notes, which are available online. The AWWA (USA) has prepared manuals on various aspects of the distribution system (see references). Effective operation of the components to maintain water quality is discussed in Chapter 16.3.

## 16.2.1 Service reservoirs

A water reservoir or tank is normally a structure that allows a different inflow and outflow at any given time. When inflow is less than outflow, water is being drawn from storage. Peak attenuation storage allows the treatment plant to produce water at more consistent treatment rates, thereby enhancing treatment performance; it also reduces the cost of building or upgrading a water treatment plant (Beca 2010). Some reservoirs or tanks have a common inlet/outlet. Unless the reservoir volume is small in relation to the water flows, this is not good design because it can lead to stale water accumulating on the far side.

Important entry points to a reservoir for contaminants include wildlife access and human access. Reservoirs should also be designed to keep the water fresh and to prevent the carry-over of sediment. Features designed to maintain water cleanliness include:

- reservoirs must have a secure lid and manhole covers designed to prevent surface runoff entering
- controls against non-authorized people gaining access. These may consist of security fences, locked manhole covers, and/or architectural constraints (tall walls with no footing/grips). Non-authorized access falls into two groups: casual/curious, and malicious. The former include children and casual passers-by; the latter may include vandals and, rarely but possibly, active saboteurs
- constraints against environmental vectors. Reservoirs are required to allow air in and out as the water level changes so they must be ventilated to the atmosphere. However, the ingress of small animals, birds and mosquitoes should be prevented. Wind carried debris and fumes should be excluded, as should surface or underground natural water which may carry contaminants. Buried tanks present a potential problem if the water table is higher than the reservoir water level. If a buried reservoir is grassed, animals should not be allowed to graze above the roof
- timber tanks should have an impermeable liner beneath the roof
- circulation systems should be built into reservoirs. There is a natural tendency for water to rotate due to the spin of the earth but this should not be relied upon to stir and mix inflows. If the reservoir does not have internal partition walls to encourage plug flow, the inlets should be sited on the far side to the outlets, and the inlets should discharge at an angle to promote circulation, see Figure 16.2. Inlets are often placed above the water surface to provide an air gap to avert back flows. Outlets are obviously placed near the bottom
- the outlet should be designed to avoid picking up any sediment that may settle out in the reservoir
- if the outlet for draining the reservoir discharges to a sewer or stormwater system, an air gap or other suitable backflow prevention must be provided
- water sampling provisions should be incorporated in the early design phase.

Figure 19.2 in Chapter 19: Small and Individual Supplies shows some design features aimed to prevent contamination of a water tank. These features apply to service reservoirs too.

**Figure 16.2: Reservoir short-circuiting: severe (left) vs moderate short-circuiting**

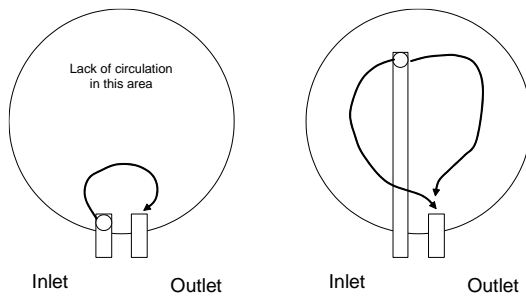

## 16.2.2 Distribution network

Water mains are broken down into a number of categories based on function:

- trunk mains: are those that connect treatment plants to reservoirs and, in some instances, reservoirs to demand areas. They are likely to have control valves and can often be taken out of service for several hours without interrupting general supply. Trunk mains rarely have customer connections and often do not have fire hydrants
- reticulation mains: are used to supply consumers directly and thus have service connections made to them. They are usually fitted with fire hydrants at about 135 m spacing. Reticulation mains may be supplied from reticulation (or service) reservoirs or, in some systems, by control valves (often pressure reducing) from trunk mains
- service connections: are where customers connect to the main. They fall into three categories: household services, multiple/commercial/industrial services and fire services.

One of the important factors influencing water quality is the effect of the various materials that come into contact with the water (see section 16.2.6). The potential effect becomes more critical as the size of the system decreases from reticulation to plumbing systems, and the residence time in contact with these systems increases. AS/NZ Standard 4020 (2002) provides a means to test such materials in order that achieving the appropriate national recommended water quality values are not jeopardised. Materials used in potable waters should comply with AS/NZS 4020, and coatings and jointing compounds should be applied and cured correctly. In the UK there is a list of products and processes that have been approved for use in their water supplies following testing (under DWI 2011). Information is also available by contacting NSF (see references). For example, NSF/ANSI Standard 61: Drinking Water System Components – Health Effects, which contains procedures to evaluate products that come into contact with drinking-water and to screen out those which might contribute excessive levels of contaminants into drinking-water.

Water distribution system materials are required to have corrosion resistance to the water inside them, not only so they do not collapse, but so that problematic materials don't pass into the water. This is discussed further in section 16.4.

Materials must also be resistant to adverse ground chemistry, the aggressiveness of the supply, and to breakages. A poor choice of materials can lead to deterioration in water quality as well as increased maintenance and early replacement.



Some pollutants such as hydrocarbons and phenols may diffuse through some plastic piping materials so attention should be given to the location of water mains in some cases. Intrusion is most likely to appear as a taste and odour issue (see section 16.2.6).

### 16.2.3 Pump stations

A pump station is installed where water must be lifted from a low level to a high level. The flow may also be pressurised to a higher hydraulic grade instead of installing a high level reservoir. Virtually all pumps used to lift water more than a few metres are centrifugal pumps.

Most pump sets comprise two pumps: one set to duty and the other on standby. This arrangement means that if the duty pump fails to start, the standby can be used to avoid production loss. To avoid accumulation of very old water in the standby system, the allocation of the duty and standby pumps should be alternated from time to time. This will also ensure that the standby pump remains functional and will spread the wear over both (or all) pump sets. Where possible, pumps should start up slowly to reduce the scouring effect of a sudden increase in water velocity that may lead to dirty water.

The lubricant used in water supply pumps should be suited to the application. Where there is any risk of contamination of the water supply, an oil designed for potable applications should be considered. There is no New Zealand standard for lubricants for use in potable applications. As a guide the lubricant should be listed under the New Zealand MAF Food Assurance Authority C15 or the United State Department of Agriculture Category H-1.

### 16.2.4 System monitoring and control

SCADA (Supervisory, Control and Data Acquisition) systems are installed on many distribution systems to monitor and control the operation of the system. Chapter 17 provides further details on how these systems work.

Typical monitoring of a water reticulation system will include:

- reservoir levels
- pump operation
- system flows at key points (perhaps into and out of reservoirs)
- system pressure
- alarm systems set to warn when action is required
- online monitoring of free available chlorine (FAC).

A key requirement of monitoring is to set operator notification limits, there is no point in recording that a system is failing if no alarm rings! The limits, and actions to be followed when reached, need to be specified in the WSP.

SCADA provides a powerful tool for checking on design information and how well a section of the system is working. For example, monitoring how full a reservoir is and how often the pump starts/stops may reveal that the storage is too small or that the on/off probes are set too close together.

### **Instruments used in the distribution system**

**Flow metering:** metering in the reticulation can occur at several locations for different reasons. Reservoir outflow meters, or meters on large primary distribution mains are used to monitor the total demand over a significant area. They are usually installed as part of the system management concerned with supplying and treating enough water. Individual property meters are small and must detect all the water drawn by the customer.

**Pressure:** proper water line pressure ensures enough supply for customers and for fire fighting, while protecting treated water from ingress of untreated groundwater. For this reason pressure is usually measured at strategic points in the distribution system.

**Level:** is measured in reservoirs as a part of a level control system and to activate alarms if the water level strays beyond acceptable bounds.

**Free Available Chlorine (FAC):** is measured in the network to ensure that a residual is maintained under all flow conditions.

## 16.2.5 Design issues affecting water quality

### Regulations covering design

Design of the distribution system should comply with current legislation for the protection of the quality of water. This is covered by the Health Act 1956 and the Health (Drinking Water) Amendment Act 2007 (HDWAA), and by the Building Act 1991 (BA).

The First Schedule of the Building Regulations made under the BA is the New Zealand Building Code (NZBC). A building with a water supply designed to AS/NZS 3500 (2003) will meet the requirements of the Building Code. AS3500.1: Plumbing and Drainage. Part 1: Water Services is called up as a verification method in the New Zealand Building Code Clause G12/AS1, and this method includes individual protection, zone protection, and containment protection. Containment protection will meet the requirements of the water supplier if a backflow preventer is installed at the boundary (also see 69ZZZ of HDWAA).

### Installation

Poor workmanship is a principal cause of water main failure and recontamination. It is important to liaise with the personnel responsible for the laying and maintenance of the distribution system to minimise any likely sources of contamination due to defective installation methods. This includes ensuring that pipes are cleaned and the ends covered while in storage and being laid. This is described more fully in section 16.3.2.

## Service reservoirs

Common inlet/outlet pipes are not recommended because they tend to allow water to become stale. Inclusion of baffle or partition walls will help reduce short-circuiting. Collection of samples for *E. coli* testing through manholes may lead to contamination, so including sample taps at the design stage is advisable. Also refer to section 16.2.1.

## Reticulation

Dead end pipes are not recommended. In areas that experience persistent dirty water, it may be possible to join dead end pipes by using right-of-ways.

## Choice of materials

Water can corrode metallic materials. The composition of the water determines the rate of corrosion. Corrosion can damage the asset and contaminate the water. The principal corrosion contaminants may include aluminium, antimony, arsenic, bismuth, cadmium, copper, iron, lead, nickel, organolead, organotin, selenium, tin, and zinc.

Lead may leach into potable water from lead pipes in old water mains, lead service lines, lead in pipe jointing compounds and soldered joints, lead in brass and bronze plumbing fittings, and lead in goosenecks, valve parts or gaskets used in water treatment plants or distribution mains. DWI (2016) conducted a study into lead leaching from the introduction of water meters, concluding that installation of meters or other fittings into lead pipes can lead to transient increases in lead concentration in the water. These elevated concentrations, mainly of particulate lead, can last for about three days and can be effectively removed by flushing.

Copper is used in pipes and copper alloys found in domestic plumbing. Copper alloys used in potable water systems are brasses (in domestic fittings) and gunmetals (in domestic plumbing valves). Brasses are basically alloys of copper and zinc, with other minor constituents such as lead and arsenic. Brass fittings are also often coated with a chromium-nickel compound. Gunmetals are alloys of copper, tin and zinc, with or without lead.

Galvanised pipes will release zinc, since they are manufactured by dipping steel pipes in a bath of molten zinc. Galvanised pipes can also be sources of cadmium and lead, since these materials are present as impurities. When the zinc has gone the steel corrodes.

Corrosion is discussed in several sections of Chapter 10. It is also covered in Health Canada (2009).

DWI (2016) summarises research into improving the understanding of the long term leaching behaviour of lead and nickel from the brass fittings. Overall project conclusions were:

- brass fittings can cause compliance failures for lead and nickel after initially being installed but leaching of these metals diminishes dramatically by 30 days in service with the flushing protocols used in this research

- all low lead fittings tested showed significantly less lead and nickel leaching compared with their leaded brass counterparts
- neither seasonal, nor stagnation temperatures, appeared to contribute significantly to the leaching for the metals of interest in the project
- phosphate dosing is effective and considerably reduces the leaching of lead and nickel from the brass fittings tested
- when phosphate dosing is stopped there is a short-lived period, of less than a day, prior to leaching commencing once more
- the yields from combinations of several brass fittings (“under the sink” and “in the road”) are capable of causing lead and nickel compliance failures in certain circumstances, significantly contributing to their concentration in water
- the use of low lead brass fittings would reduce the likelihood of currently sold brass fittings contributing significantly to the compliance of UK households
- other metals of interest such as copper, zinc, aluminium, manganese and cadmium did not cause compliance failures, from either individual or cumulative test fittings
- phosphate dosing can also suppress the leaching of zinc and copper in both hard and soft water.

## 16.2.6 Permeation, leaching, intrusion and pressure drop

Water quality can be affected by the types of materials used in the distribution system and for the plumbing, and on the design and condition. Water quality can also be affected by the nature of the ground in which the pipes are buried, or by substances discharged to the soil. ANSI/AWWA have produced Standards for a wide variety of pipe types, fittings, tanks and water meters.

Permeation is a phenomenon in which contaminants migrate through the pipe wall into the water. Three stages are involved in physico-chemical process of permeation:

- a) organic chemicals present in the soil partition between the soil and plastic wall
- b) the chemicals diffuse through the pipe wall
- c) the chemicals partition between the pipe wall and the water inside the pipe (Kleiner 1998).

Leaching is the process whereby chemicals enter the water supply from the materials used in the distribution system and plumbing, other than by corrosion processes. The AFNOR XP P41 250, EN 1420-1 and BS 6920-2.2.1 are migration/leaching testing standards used in France, Europe, and Britain respectively. All products used for the transport of water intended for human consumption are meant to be subject to these testing standards. Pre-testing and certification of materials does not always guarantee that taste and odour problems caused by leaching of organic compounds will not occur. Significant problems may also arise from improper installation of approved materials.

Intrusion occurs when contaminants are drawn into the pipework through holes.

## a) Permeation

Permeation can occur either from the vapour or aqueous phase. With respect to potable water mains, the contaminants of interest include highly volatile hydrocarbons and organic solvents. Therefore, both water mains and fittings installed in the vadose and saturated zones are susceptible to contamination by permeation. Thermodynamic theory indicates that hydrostatic pressure within the pipeline provides negligible resistance to permeation at the pressure range commonly found in the distribution system.

More than 100 incidents of drinking-water contamination resulting from permeation of subsurface mains and fittings have been reported in just the United States (Glaza and Park 1992). The majority of these incidents were associated with gross soil contamination in the area surrounding the pipe. The occurrence of permeation incidents was equally split between high risk locations such as: industrial areas; former sites of fuel stations; near underground storage tanks; and low-risk locations such as residential areas. The sources of contamination for the low-risk areas included disposal and accidental leaking of gasoline, diesel fuel, oil, paint thinner products or solvents, Holsen et al (1991). A property next to a service station in Mt Albert, Auckland, experienced bad tastes and odours in their drinking-water in the early 1980s.

Pipes composed of polymeric materials (ie, plastics) were involved in 98 percent of the US incidents. The materials included polybutylene, polyethylene, polyvinyl chloride (PVC), and acrylonitrile-butadiene-styrene (ABS). No reported incidents of permeation through metal-based pipe were identified.

The contaminants most likely to permeate plastic are lipophilic and non-polar in nature. Diesel and petroleum products (mainly benzene and ethylbenzene) were involved in 89 percent of the incidents, while volatile chlorinated solvents accounted for 5 percent of the incidents. Other contaminants that exhibited high rates of permeation included (simple) chlorinated aromatics, chlorinated and unchlorinated straight-chain aliphatic hydrocarbons, and phenolic compounds. The taste or odour of ethylbenzene and xylenes are detectable before they reach concentrations of health concern; however, for most other chemicals that permeate the pipes, the opposite applies.

New PVC pipes exhibit lower permeation rates than new polyethylene or polybutylene pipes, primarily due to differences in the material matrices. PVC is an amorphous glassy polymer, while polyethylene and polybutylene are semi-crystalline rubber. At low solute activities, PVC is virtually impermeable. However, when exposed to high activity (eg, saturated) organic conditions, such as those that would occur during gross chemical spillage, PVC pipe can be softened to the point of failure.

WHO (2014) includes some interesting examples of permeation in Appendix 10.

## b) Leaching

ANSI/NSF Standard 61: *Drinking Water System Components – Health Effects* establishes minimum health effects requirements for the chemical contaminants and impurities that are indirectly imparted (via leaching) to drinking-water from products, components, and materials used in drinking-water systems.

Tombouliau et al (2004) listed the chemicals found by NSF to have leached from various water system components into the water, as below. Datasheets have been prepared for many of these compounds.

### Cement/concrete pipes/lining

2,4,6-tribromoanisole; 2,4,6-tribromophenol (Bromol); 2,4,6-trichloroanisole (Tyrene); 2,4,6-trichlorophenol; antimony; calcium carbonate; calcium sulphate; chromium; diethanolamine; diethylene glycol; dioxin (TCDD); dipropylene glycol; dipropylene glycol-*t*-butyl ether; furan; iron oxide; magnesium oxide; melamine-sulfonate; naphthalene-sulfonate; *o*-phenylphenol; phenoxypropanol; tetracalcium trialuminumosulfate; tetraethyl diphosphate; triethanolamine; vanillin.

### PVC/CPVC pipes

1,3-butadiene; antimony; calcium carbonate; calcium stearate; carbon black; chlorophenol; cyclohexanone; dibutyltin; diethylhexylphthalate; disononyl phthalate; ethyl acrylate; formaldehyde; monobutyltin; paraffin wax; polyethylene wax; titanium dioxide; tributyltin; vinyl chloride.

### Polyethylene, HDPE, PEX pipes/lining

acetophenone; 2,4-bis (dimethylethyl)phenol; benzene; benzothiazole; bis-(dimethylethyl)benzene; bisphenol A; BHT (methyl di(*t*-butyl)phenol); carbon disulphide; cyclohexadienedione; cyclo-hexanone; cyclopentanone; diazadiketocyclo-tetradecane; dicyclopentylone; dimethylhexanediol; di-*t*-butyl oxaspirodecadienedione; hydroxymethylethylphenyl ethanone; isobutylene; methanol; methyl butenal; methyl di-*t*-butyl hydroxyphenyl propionate; methyl (di-*t*-butylhydroxy-phenyl)propionate; methylbutenol; nonylcyclopropane; phenolics; phenylenebis-ethanone; propenyloxymethyl oxirane; *t*-butanol; tetrahydrofuran; trichloroethylene. Skjevraak et al (2003) found 2,4-di-*tert*-butylphenol (2,4-DTBP) which is a known degradation product from antioxidants used in HDPE pipes.

They also identified a range of esters, aldehydes, ketones, aromatic hydrocarbons and terpenoids leaching from HDPE pipes, the main ones being methyl and ethyl tertiary-butyl ether. Durand and Dietrich (2007) identified 2-ethoxy-2-methylpropane leaching from PEX pipes at 0.02 to >0.1 mg/L; panellists were able to smell the chemical at 0.005 mg/L.

## Polyurethane coatings and liners, flexible fabric-reinforced polyurethane piping

1,4-butanediol; 4,4'-methylenedianiline; bis(2-ethylhexyl) phthalate; bisphenol A diglycidyl ether; butyl benzyl phthalate; diphenyl(ethyl)phosphine oxide; di-*t*-butyl methoxyphenol; ethylhexanol; tetramethyl piperidinone; toluene diamine. DWI (2011a) reports results of a leaching study of flexible fabric-reinforced polyurethane piping. Only low levels of leaching were observed from the original liners that had been in use for many years. Chemicals were still detected in stagnation samples several weeks after new liners were installed. This suggests that it would not be practical or effective for the manufacturer to rinse the risers as part of the manufacturing process. Concentrations of leached chemicals in samples taken after flushing tended to be low. The major unknowns were identified as a series of oligomers (compound intermediate between a monomer and a polymer, normally having up to about ten monomer units) having molecular weights of 288, 360, 432, 504 and 576. These compounds are likely to be oligomeric cyclic ethers. The chemicals were still detected in stagnation samples several weeks after the liners were installed.

## Epoxy coatings and liners

1,1-dichloroethene; 1-methoxy-2-propanol; 4,4'-methylenedianiline; benzaldehyde; benzidine; benzyl alcohol; bisphenol A; bisphenol A diglycidyl ether; bisphenol F; butoxyethanol; diethylenetriamine; diphenyl ether; epichlorohydrin; ethylbenzene; ethylhexanol; isobutyl acetate; isopropoxy propanol; methylisobutyl ketone; *n*-butanol; *n*-butyl acetate; nonylphenol; phenol; toluene; tripropylene glycol; styrene. DWI (2007) reported 2,4-di-*tert*-butylphenol leaching from one brand of epoxy (now withdrawn from sale), the maximum concentration was 0.0022 mg/L.

## Joining and sealing materials (adhesives, caulk, flux)

diethyl phthalate; ethanolamine; lead; methacrylic acid; organotins.

## Nitrile-butadiene rubber gaskets and O-rings

1-phenylethanone; 2-(2-butoxyethoxy)ethanol; 2,4,5-trichlorophenol; 2-ethyl hexanol 2-phenyl-2-propanol; acrylonitrile; benzothiazole; benzothiazolethione; benzothiazolytiomorpholine; bis-(ethylbenzyl) ester; butadiene; butoxyethoxy ethanol; carbon disulphide; cyclooctadiene; dicyclohexyl urea; dimethyl carbamic chloride; dimethyl cyclohexyl urea; dimethyl dithiocarbamate propionitrile; dimethylethyl phenol; diphenyl guanidine; isocyanatocyclohexane; isothiocyanatoethane; mercapto-benzothiazole; methoxybenzene; tetramethylthiourea; tetramethylurea; tri(butoxyethyl) phosphate; tripropenyl triazinetrione.

## Styrene butadiene rubber gaskets and O-rings

1,2-dichloropropane; 2,4,5-trichlorophenol; acetophenone; alpha-methylstyrene; benzothiazole; dimethyl benzene methanol; diphenyl guanidine; di-*t*-butylhydroxy-methyl cyclohexadienone; methylene chloride; methyl octanoate; phenylbenzenediamine; 1-phenylethanol; phenylethylphenol isomers; styrene; tetrabutyl urea; trimethyl quinoline.

## Lubricants (grease, silicones, primers, sealants)

3-chloro-1,2-propanediol; cyclohexanone; *p*(*t*-butyl)phenyl glycidyl ether; silicones.

## Solder

copper; antimony.

## Thread compound

benzaldehyde; diacetone alcohol; ethoxylated bisphenol A dimethacrylate; lead; methacrylic acid; methanol; phenolics; tetrachoroethane; tetramethylene glycol dimethacrylate.

Polyvinyl chloride (PVC) mains manufactured prior to 1977 contained elevated levels of vinyl chloride monomer, which were prone to leaching. Water quality samples collected from a rural water system in Kansas, which had installed over 100 miles of pre-1977 PVC, contained as much as 0.014 mg/L of vinyl chloride (MAV = 0.0003 mg/L). Sadiki (1998) found organotin compounds in a water supply increased to health-significant levels as it passed through a PVC distribution system in Canada. Lead and zinc have been found to leach as well.

In a study reported in USEPA (2002), the installation of 7200 feet of cement-mortar lined ductile iron pipe caused aluminium levels in a water supply to increase from 0.005 mg/L to 0.69 mg/L over the course of two months. More than two years later, aluminium continued to leach from the lining and produced water with over 0.10 mg/L of aluminium. This was attributed to several illnesses and a 32 percent mortality rate at a receiving dialysis centre.

Alkyl benzenes and PAHs have been found frequently in drinking-water where bituminous, asphaltic and coal tar linings have been used in pipes and tanks (USEPA 2002).

Solvents used in epoxy resins, mainly xylenes and isobutyl ketone (MIBK), have been found in drinking-water a month after application; longer curing periods produced more stable linings.

The UK DoE (1990) reported a degradation product, 2,6-di-*tert*-butyl-*p*-benzoquinone, to be a common contaminant in water distributed by MDPE pipe. They also found phthalimide which proved to be an impurity related to the blue pigment copper phthalocyanine. DoE also reported that a range of phthalates and styrene were amongst a wide range of organic chemicals that leach from GRP pipe.

The chemicals detected in drinking-water can vary depending on the composition of the water, particularly pH. The presence and concentration of free chlorine and chloramine in the drinking-water can modify the chemicals being leached. Higher temperatures usually increase the leaching rate. Materials made by different manufacturers can result in different levels of taste and odour. Some materials such as cross-linked polyethylene are manufactured by distinctly different processes, eg, PEX (a), PEX (b) and PEX (c), and these leach differently, largely based on the different chemicals used as reaction initiators, reaction conditions, and antioxidants.



Durand (2005) studied the impact of pipe materials on the odour, disinfectant residual and TOC levels in drinking-water. She found domestic plumbing materials to have the potential to affect water quality characteristics such as TOC concentrations, residual disinfectant and odour when newly installed in homes, especially during the first weeks of service. Aqueous TOC concentrations increased as much as 1 mg/L for some materials. The increased TOC observed for many plumbing materials was consistent with the presence of a distinct odour or a high flavour profile analysis (FPA) intensity rating. The descriptors most consistently used to describe odours from both plastic and metallic pipes were: plastic, oily, chemical and solvent. Galvanised iron produced the worst odours that were consistently described as motor oil, with FPA intensity ranging from 4–6. This material generated the most intense odours, which were still very noticeable after 177 days. Polyethylene generated more intense plumbing associated odours than PEX or cPVC plastic material. The least odorous materials were chlorinated polyvinyl chloride and copper. Both copper pipe and epoxy-lined copper consumed residual chlorine and chloramines. Understanding the interaction of materials and water quality is a complex task.

### c) Intrusion

Edwards (2004) referred to various studies that showed contaminants can be drawn into distribution systems through holes in pipes during pressure transients caused by surge or water hammer. Likewise, contaminants can enter below ground level aqueducts and service reservoirs by gravity. The volume of soil water that can enter the pipework has been estimated to range from a few mL to hundreds of gallons. Therefore leakage control and watermain repair programmes also have a water quality protection component.

LeChevalier describes a cause of transient pressure (from USEPA 2002):

Consider a pipeline on which an open valve is located at a distance downstream from a reservoir. If the valve is closed instantaneously, water will decelerate to zero velocity and the kinetic energy will be converted into pressure. The transient wave will travel upstream and downstream from the valve and ultimately reach the ends of the pipe. If the pressure wave in the pipe is not relieved (as in a surge tank), it will travel in the reverse direction back to the valve. Because the valve is closed and there is no relief for this flow, a negative pressure wave (suction) will be created at the valve. This wave will travel back and forth until the kinetic energy is dissipated by friction. The process will occur both upstream and downstream from the valve. However, the initial pressure will be positive on the upstream side and negative on the downstream side.

Pressure transients can be caused by main breaks, sudden changes in demand, uncontrolled pump starting or stopping, opening and closing of fire hydrants, power failures, air valve slam, flushing operations, fire flow, feed tank draining and other conditions including venturi effects. Intrusion can occur through leakage points, submerged air valves, faulty seals, or other openings. The report shows many instances of negative pressure.

Having an understanding of what leaks out of a reticulation network gives an indication of the risk of contaminants that could potentially enter it during a low pressure or maintenance situation. The Infrastructure Leakage Index (ILI) for the majority of New Zealand municipal suppliers is in the moderate (2.0–4.0) to high (4.0–6.0) criteria by international comparison. Ofwat recently fined Thames Water £120 million for not meeting their water leakage rate reduction target; they had a leakage rate of 14.4 percent. By comparison New Zealand suppliers are typically >20 percent with some recording 38 percent. The World Bank suggests:

**Table 2.3 World Bank Institute Bands for Leakage Management in Developed Countries**

| Band | ILI Range    | Guideline Description of Real Loss Management Performance Categories for Developed Countries   |
|------|--------------|--|
| A    | < 2.0        | Further loss reduction may be uneconomic unless there are shortages; careful analysis needed to identify cost-effective leakage management                 |
| B    | 2.0 to < 4.0 | Possibilities for further improvement; consider pressure management, better active leakage control, better maintenance                                     |
| C    | 4.0 to < 8.0 | Poor leakage management, tolerable only if plentiful cheap resources; even then, analyse level and nature of leakage, intensify reduction efforts          |
| D    | 8.0 or more  | Very inefficient use of resources, indicative of poor maintenance and system condition in general, leakage reduction programs imperative and high priority |

Mains breakage rates could be seen as an indicator for network condition. Many developed countries measure this and have established what they consider to be a reasonable target. It is probable that very few New Zealand water suppliers record this information at present.

#### d) Pressure drop

There is evidence emerging from the United States that changes in water pressure alone is sufficient to induce ingress of extraneous material into a water main. Such changes might be short term providing a pulse of contamination that will not be detected by monitoring. Work has been done by Mark LeChevalier for the American Water Works Association Research Foundation using high speed pressure recorders to show that a number of transient negative pressure events can occur. Soil lining the outside of a water main has been shown to contain total coliforms, faecal coliforms and enteric viruses. Pressure drop is of such concern in some states (eg, Ohio) that if pressure sensors indicate that water pressure has fallen below 20 psi, a boil order is issued (from DWI 2002a).

The reduction of pressure in a pipe or zone can occur in a number of ways, ie:

- high localised demand (including firefighting)
- zones with challenging geographical conditions
- pumps starting and stopping
- valves turned off in parts of a zone for maintenance
- low reservoir levels
- flow rates exceeding design capacity
- power failure for pressurised pumped zones.

Ideally water suppliers will have a distribution system management plan to address the above issues, also covering mains installation and repair (section 16.3.4). With respect to pressure, it is recommended that:

- where hydraulic modelling indicates possible risk of pipe pressure going below 10 m static head, continuous online pressure monitoring and alarms are installed at that location
- each zone has, as a minimum, one continuous online pressure monitoring and alarm installed at a convenient place near the highest risk location (furthest from the reservoir or water source).

## 16.3 Operations and maintenance

Because the distribution system is the final stage before the drinking-water is consumed, there are no further barriers between the entry of a contaminant and the consumer, so particular care is required.

Proper training and supervision of the maintenance workers responsible for the distribution system is essential. This includes sanitary training and clearance (refer section 16.3.4).

Full and detailed documentation of the distribution system and its components will be undertaken in a fully comprehensive manner by most operating authorities when asset management systems are put into operation, International Infrastructure Asset Management Manual published by ALGENZ. These can be used as a tool in identifying maintenance requirements and potential trouble spots.

Some general information is also available in the Ministry of Health's PHRMP Guide: Distribution System – Operation. The AWWA (USA) has produced standards for the disinfection of water treatment plants, water mains, and water storage facilities, and a standard for distribution systems operation and management, see ANSI/AWWA references.

### 16.3.1 Service reservoir operation

Water quality can be influenced by periods of storage. To minimise the effects, good operating practices and regular maintenance are required.

#### Mixing and turnover

Reservoir operation should encourage turnover of water at least every few days. If a reservoir is filled and remains so, it is likely that fresh water is going directly to the users while the water in the reservoir sits for considerable time. This situation is common where the inlet and outlet mains are the same pipe, often supplied by a pump.

The reservoir should draw down to ensure mixing and renewal is occurring. The flow-balancing feature of a reservoir (allowing constant treatment plant operation, attenuation of peak flows, etc) requires the volume to change. The minimum operating level to allow for emergency storage should be assessed and the reservoir operated accordingly.

Quality may deteriorate rapidly if the water in a reservoir is not kept fresh. The chlorine will either combine with any residual organic material in the water to form mono-, di- and tri-chloramines, or dissipate into the atmosphere. The former may result in poor taste and odour (complaints will be received at about 0.05 mg/L of trichloramine). Dissipation will result in inadequate chlorine residual to prevent regrowth of micro-organisms.

Some service reservoirs or tanks are designed to provide flow to high areas during peak summer demand. Consequently, the water may sit there for many months. Procedures for dealing with this should be documented in the WSP.

## Reservoir inspection

Reservoir inspection can be classified into the following categories:

- inspection of hydraulic controls
- inspection of cleanliness and security
- inspection of structural condition. The underside of the roof of buried reservoirs needs to be inspected for drips entering the reservoir through cracks in the roof material or breaks in the jointing material. The sound resulting from leaks tend to come from a consistent area, whereas the sound from condensation drips tends to be more random. Leaks often occur where roots can be seen to have penetrated the roof.

Hydraulic controls should be part of a routine maintenance programme. Typical frequency of inspection that valves are functioning correctly would be quarterly.

Cleanliness and security should also be checked routinely, typically at least quarterly depending upon both the access security risk and the testing programmes in place. The water surface should be examined for floating objects. Thistledown is an indicator that wind-blown objects are able to get into the water, and feathers or nesting material is evidence that birds have found a wee gap. Oil slicks and road dust have been found on the water surface of service reservoirs near busy roads. The clarity of the water should be adequate to examine the bottom of the reservoir with the aid of a reasonable torch or similar. In many situations, a clean piece of PVC pipe will be useful to stir the bottom to give an indication of sediment build-up. Divers may be used, provided cleanliness procedures are followed. They will provide a better picture of how much sediment is present, and in performing structural checks (floor displacement, joint sealant positions, deterioration etc) than is possible from above the water surface. They may also be used without disruption to the supply.

A person experienced in detecting cracking, corrosion, and foundation stability should check structural integrity regularly. This may be the system operator or an engineer (who may further train the operator).

## Reservoir maintenance cleaning

Water reservoirs can act as sedimentation tanks. Over time it is usual for sediment to accumulate on the floor of the reservoir. It is also possible that slimes, algae (if light can penetrate), or chemical deposits will accumulate on the interior walls. Eventually the accumulated material can adversely affect the quality of the water.

The initiation of a reservoir cleaning procedure may be due to any one of:

- customer complaints about taste, odour or appearance
- water quality testing showing quality degradation
- random checking showing a clean is due
- the sludge depth is reaching the height of the outlet
- planned maintenance procedures or design modifications.

If the procedure has been initiated by customer complaints or finding *E. coli*, the problem is urgent and should be attended to directly.

Planned maintenance frequency requires the accumulation of experience of the particular reservoir; there is no golden rule for how often any particular reservoir should be cleaned. The frequency is likely to be around six months to four years, rather than some shorter time interval. A regular inspection programme, coupled with water quality testing, is the best way to assess this frequency. A key variable is the quality of the incoming water; if it is of low quality, more sediment will be trapped and more organic growths may be expected.

Reservoir cleaning will involve time and cost and may cause disruption of supply to customers. These factors make a lower frequency preferable to frequent cleaning. In assessing the frequency, the bottom line is minimising risk to public health. The free available chlorine content of the water after refilling should be at least 0.30 mg/L and ideally this residual should exceed 0.20 mg/L 24 hours later; any lower residual suggests that the reservoir was refilled while still dirty. Samples from different depths should be collected for *E. coli* testing. Supplementary chlorination will be required if the chlorine dissipates more rapidly than expected, or if *E. coli* are found. The procedure for reservoir cleaning and restoration to service should be documented in the WSP.

### 16.3.2 Reticulation operation

The main causes of recontamination of water in the distribution system are poor mains laying, the use of inappropriate types of distribution pipe/fittings, poorly planned and coordinated maintenance systems, and inadequate training/supervision of staff or contractors. These can be overcome by good system design, a good asset management system, writing and following a suitable WSP, and appropriate training systems.

Distribution systems are generally designed to ensure hydraulic reliability, which includes adequate water quantity and pressure for fire flow, as well as domestic and industrial demand. In order to meet these goals, large amounts of storage are usually incorporated into system design, resulting in long residence times, which in turn may contribute to water quality deterioration. Section 16.2.6 discusses water quality issues that can result from leaks and poor pressure control.

Should a main break require some significant time to repair, a temporary bridge between fire hydrants may provide some continuity of supply. This, coupled with tanker delivery, may provide a sufficient quantity of drinking-water. Public notices (eg, radio or leaflet drop) advising whether boiling the water is needed and advice on water conservation will be required. The procedures to be adopted following main breaks should be covered (or referenced) in the WSP.

Some pump stations are designed to provide pressure to high areas during peak summer demand. Consequently, the water may sit in the associated pipework for many months. Procedures for dealing with this should be documented in the WSP.

The most direct sources of contamination of reticulated water supplies arise from:

- older style ball hydrants that will open of their own accord under loss of system pressure
- open fire hydrants during mains repairs or hydrant or pressure checking
- direct entry into broken mains or services
- backflows from individual properties.

Most authorities have replaced the old ball hydrants. The few that remain may be at points that are difficult to shut down to allow their replacement.

Figure 16.3 shows how dirty the water can be during flushing. When testing hydrants, or when flushing a main, it is important to continue the flushing procedure until the water appears to be clean. For example, grit has been known to block consumers' water meters and Ajax valves. WRF (2015b) provides an in depth discussion on the removal of manganese from water mains. Hydrant testing guidelines are outlined in NZ Fire Services Firefighting Water Supplies Code of Practice, SNZ PAS 4509:2008.

Fire hydrant contaminant entry after draining down for repair can be minimised by the use of standpipes on the hydrants. This restricts the level of the water drained from the main and is thus unpopular with service personnel. This is primarily a training and attitude matter – most service trucks carry a standpipe. Direct contamination entry during repair is also essentially a training and attitude issue.

During small-scale repairs, individual properties may be supplied from a neighbour's garden tap, often to the garden tap of the property without a supply. In such cases, the loss of integrity and use of non-disinfected piping may compromise the safety of the water. Suitable warnings should be issued about potability. Suppliers should have documented procedures for informing customers of interruption to supply and ensure that all staff complies with these. There is a natural tendency to stop the flow (completely!) and pump out a hole to see what is going on. To do otherwise requires training.

**Figure 16.3: Fire hydrant standpipe being used to flush a water main**

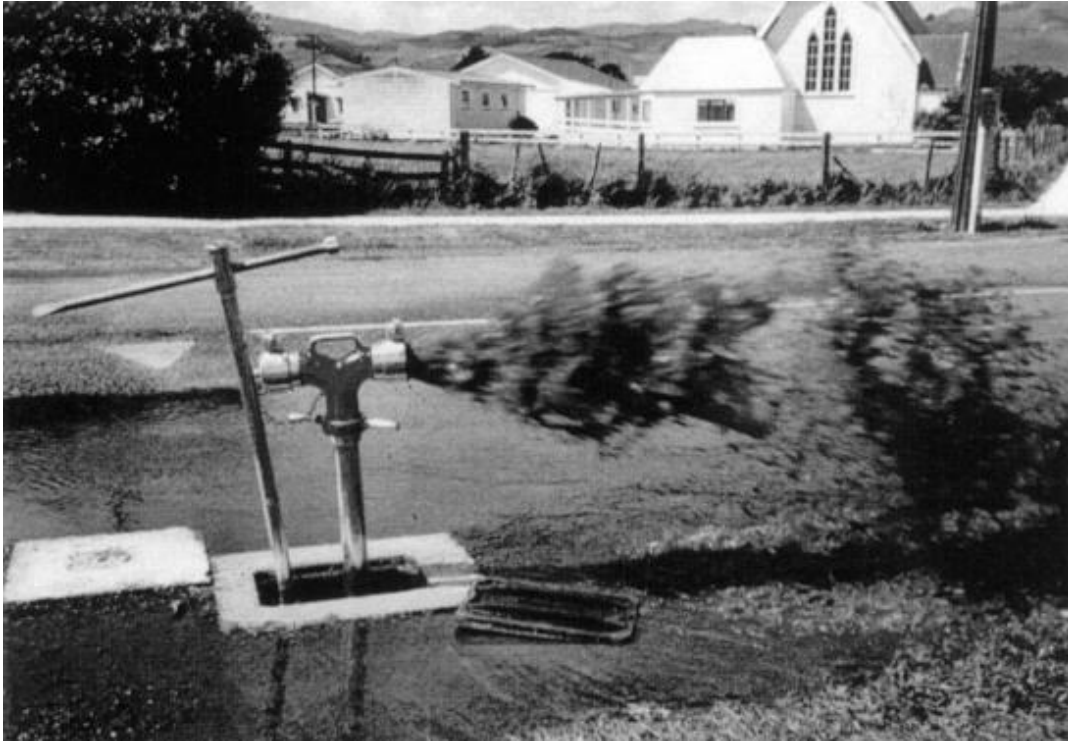

## Backflow prevention

Backflows are defined as the flow of (possibly contaminated) water from the consumer's premises into the public supply.

Backflow and backsiphoning events are more common than most water suppliers and consumers realise or acknowledge. Overseas studies have indicated about 12,000 incidents per annum in a population of 1,200,000, a frequency of about 1 incident per year per hundred people served. Studies have not been reported in New Zealand but are probably similar. Not all of these events result in illness, but all represent a potential incident.

From 1981 to 1998, the CDC documented 57 waterborne outbreaks related to cross-connections, resulting in 9734 detected and reported illnesses. The USEPA compiled a total of 459 incidents resulting in 12,093 illnesses from backflow events from 1970 to 2001. The situation may be of even greater concern because incidents involving domestic plumbing are even less recognised (WSTB 2005).

The Australian Plumbing Code Development Research Report (2015) summarised cases of backflow incidents and cross-connections which occurred predominantly in the USA, with some in Australia, between the years 1933 and 1990:

- the most common premises type was colleges and schools (18 percent), followed by 'not recorded' (10 percent), and shipyards (8 percent). Apartment buildings, houses, farms, and 'chemical plants' each accounted for 3 percent of the cases



- main breaks and pressure drops (fire service drawdown, etc) were involved in 29 percent of cases. The most common specific cause was human error (39 percent), followed by equipment failure (31 percent); accidents/natural disasters (12 percent), then sub-standard work (6 percent)
- backsiphonage (43 percent) was more common than backpressure (18 percent); accidental cross-connection accounted for 25 percent of cases
- the most common pollutants were sewage (14 percent), fire-fighting water (10 percent), and corrosion-inhibitors (8 percent).

The American Backflow Prevention Association estimated the extent of backflow incidents in the USA to be around 100,000 per day where some type of contaminant infected a municipal water supply, including those where no harm was caused. The most common cross connections reported were from irrigation, followed by fire systems, garden/washdown hoses, and boilers.

It is necessary for the water supplier to ensure that there is sufficient positive pressure through the pipes to prevent any backflow or inflow that could contaminate the supply. The network must be monitored to ensure that this is so. This is particularly important when pipes are buried in areas where the water table is high. DWI (2008 and 2011) discuss the effects of abnormal pressures on water quality in some detail. Their main recommendations were:

- 1 Additional proactive measures are not required to minimise an already low probability of very low pressures occurring.
- 2 The practice of designing distribution systems with alternative routes to most customers (ie, with loops) should continue.
- 3 Good practice should be followed with respect to:
  - opening and closing valves and hydrants slowly
  - running hydrants at the lowest necessary flow
  - returning mains to service (disinfection)
  - disinfecting local mains which have drained as a consequence of work on other mains
  - implementing soft start and stop for pumps
  - maintaining PRVs and maintaining pressures during maintenance.

The network should also be modelled in some way to ensure that the necessary capacities and water pressure criteria are met under all conditions. This may be done by hand, or, more commonly, by computer modelling. The most powerful method for modelling distribution networks is by the use of purpose specific software packages.

For their part, the customer must also prevent backflow into the system by the installation of specific devices to prevent it. Backflow prevention requirements were set out in the Water Supply Protection Regulations 1961, which have been superseded by the HDWAA; backflow is covered in 69ZZZ.



The Building Act (2004) *Approved Document for New Zealand Building Code Water Supplies* Clause G12 (2nd edition) section 3.41 states that backflow protection shall be provided wherever it is possible for water or contaminants to backflow into potable water supply systems. There have been many accounts of faulty installation (eg, installed back-to-front) and inadequate servicing (eg, the annual inspections are often overlooked). Figure 16.4 shows a backflow prevention device being commissioned. The objective is to safeguard the health of people within the building by installing a backflow device at each source of possible contamination. Approved methods are set out in this Act and include:

- air gaps reduced
- pressure zone devices
- double check valves
- vacuum breakers.

Further information is available in the *Cross-Connection Control Manual* (USEPA 2003). The manual includes discussion on a series of well-illustrated case histories.

An appropriate device is required for the hazard level. G12 has definitions of the hazard levels, High, Medium and Low, and lists of possible examples for each. As well as protecting the internal water supply system, G12 section 3.1 requires that water drawn from the water main shall be prevented from returning by avoiding cross-connections or backflow.

**Figure 16.4: Commissioning a backflow prevention device**



Backflow prevention programmes are in place for new service connections but a high percentage of properties in New Zealand have supply connections predating the Building Act 1991.

The Backflow Special Interest Group of NZWWA, in consultation with the Building Industry Authority (BIA), produced Backflow Prevention for Water Suppliers, Code of Practice (updated 2006, revised 2013), in response to the Ministry of Health Public Health Risk Management Plan (PHRMP) Guide – Distribution System – Backflow Prevention.

Once a water supplier has undertaken the risk assessment as part of the WSP process, then the code of practice (CoP) provides a best practice approach to reducing the risk of backflow.

The primary focus of the CoP is on containment (boundary protection) and the protection of the public water supply. As a result, there is a need for the development of policies and the risk assessments in order to support this focus. The CoP can be incorporated into water suppliers' water bylaws.

The biggest question of concern for most water suppliers when developing a policy is that of the ownership of containment devices. Ownership in the CoP is primarily with the water supplier outside the boundary or upstream of the defined point of supply. Devices and testing is at customers' cost through connection charges and supply agreements.

There are benefits to the water supplier owning the containment devices in terms of better asset management and not coming into conflict with the Building Act (2004). If the water supplier chooses not to own the containment devices then a building consent is required. In both cases the water suppliers and customers' responsibilities are detailed including payments of costs, enforcement, change of use, record keeping, etc.

Testable containment devices are recommended for all non-domestic connections. A New Zealand testing standard has been produced (Master Plumbers 2018). The device selection and specification is the responsibility of the water supplier regardless of ownership, and guidelines are provided in the CoP. All domestic connections should include at least a dual check device, under the hazard level of very low introduced in the WSP. Fire supplies are covered in detail. In consultation with fire industry specialists it was deemed best practice for fire sprinkler systems that the containment device is located in the valve house as per the G12.

The CoP states that the person undertaking the annual testing of containment devices shall have passed a 40 hour backflow testers' course. Surveying of existing sites is covered in the CoP. Persons who survey existing buildings to assess the overall hazard level and if the current backflow prevention is adequate, must also have the appropriate qualifications.

Metrowater found discrepancies in backflow test results during an audit of Auckland City's public water supply. This prompted a request that all backflow test kits used by IQPs (Independent Qualified Persons) within the Auckland Metrowater zoned area be recalibrated and certified (as per the NZWWA Backflow Prevention for Drinking Water Suppliers Code of Practice 2003). One Telarc Registered Laboratory found that 97 percent of the kits they tested failed. Test kits that fail require repair and recalibration before they can be certified. Certification of backflow testing equipment is of vital importance to the accuracy of the tests being carried out and ultimately the

protection of the water supply. It is therefore recommended that test kits be recertified every 12 months by a Telarc registered laboratory.

NZWWA in conjunction with the Master Plumbers, Gasfitters and Drainlayers NZ Inc have formed a committee to assist Standards New Zealand produce a new standard 'Field testing of backflow prevention devices and verification of air gaps'; a draft appeared in 2010. This new standard is being developed as a replacement for AS 2845 Water supply – backflow prevention devices, Part 2 Registered air gaps and registered break tanks, and Part 3 Field testing and maintenance of testable devices. It will be more suitable for use in New Zealand as it will reflect the regulatory environment and the procedures currently in use.

Backflow and backsiphoning are discussed in WHO (2006, Chapter 15).

WRF (November 2016): Automatic Meter Reading (AMR), and Advanced Metering Infrastructure (AMI) systems have shown that numerous meter communicating systems exist to detect reverse flows and transmit data from residential meters to utilities. Data collected from over 60 districts in the American Water system from September 2012 to August 2013 were used to create a large database (over 1,000,000 individual meter reads). This showed over 14,500 separate reports of reverse flows, with monthly occurrence ranging from a low of 535 reports in September 2012 to a high of 1,761 in March 2013. With the advent of a new meter data management system at American Water, instituted during 2015, a more comprehensive analysis that distinguished between major (10 gallons or more) and minor backflows was conducted to cover all activity during 2015. This showed that the vast majority of backflows are minor in nature. The data from major backflows were organised in spreadsheet form from the meter data management system and covered several months. Data were then used to detect the categories of backflows and prioritise subsequent investigations. These spreadsheets were later augmented by graphic displays of data that aided in rapid identification of possible operational issues from multiple backflows in neighbourhoods (meter routes) and individual locations with repeated backflow events over time.

## Mains cleaning

Water mains gradually accumulate sediments and corrosion products, particularly where flow velocity is low. In some cases biofilms will form that must be cleaned off (biofilms are discussed in section 16.4.1). There are two main methods for cleaning mains: flushing and pigging.

Flushing, by running the main at a high velocity (ideally 1.5–2 m/s) to waste, will generally control the rate of accumulation. Flushing must continue until satisfactory clarity is obtained. This is a routine task that may need to occur every few months, or only once every two or three years. Problem dead-end mains may require weekly flushing. Some water suppliers only flush their pipes on an as needed basis. The procedure and programme should be documented in the WSP or other appropriate manual. Inclusion of air can improve the flushing performance.

The flushing water is typically disposed of to the stormwater drain. Water with significant chlorine levels has the potential to kill fish, and/or the organisms on which they feed. It may be necessary to neutralise the chlorine. When this is done with chemicals such as sodium thiosulphate, they should not be overdosed, as they will also damage the receiving environment.

Pigging involves passing a fluid-propelled object through an isolated section of the pipe. A foam plug is often used as the pig. It is normally the same diameter or slightly larger than the water main and is shaped like a torpedo. Care should be taken to isolate the service connections so that poor quality water and pieces of pig are contained.

When foam pigs are used then the type of pig, the distance travelled, time used, and its efficiency should be recorded in order to appraise the cleaning operation. If a scraper is to be used then notice should be taken of the type and quality of the lining inside the pipes, so the integrity of the lining and joints is not compromised. This may lead to the reapplication of interior linings.

Asbestos cement mains and mains less than 150 mm diameter are not normally pigged.

CCTV pipe inspection may be needed before and after cleaning.

WRF (2016a) reports the findings of an extensive study into the accumulation and release of metals in the distribution system, and evaluates mains cleaning methods.

### **Reticulation system records**

**Record plans:** Most community water supply plans start out with initial construction plans showing where and how the original mains were laid. These plans are still used as part of contract drawings for most construction work.

There is generally a requirement for as-built plans to be completed showing departures (if any) from the original design and position.

These construction plans, whilst giving key details of many items, are not suitable for the primary records purpose of what is buried where, and how the whole system is linked.

To provide this function, most communities have indexed records plans of underground services, including water mains, on a street basis, normally organised into sheets. The sheet will often list construction drawing numbers for detailed information if needed.

Many water suppliers use geographic information systems (GIS) to record the location and other attributes of their underground pipe networks. Further software is used for assessment management systems (AMS) with the most common in current use called MIT-Hansen 'PAMS' (pipe AMS). These systems allow maintenance records and other relevant data to be stored as well as total asset evaluation for accounting purposes. Asset Management is described in detail in the *International Infrastructure Asset Management Manual* published by ALGENZ.

**Fire flow records:** Most communities that have fire hydrants to provide fire protection also have a fire brigade. A routine brigade task is to flow test the hydrants in their area, partly for the flow information, but also to check markers are present, etc. In some areas, this data is logged by the council on the PAMS; in others it may be available as a paper copy of the fire brigade hydrant sheets. It is very useful data on the reticulation system performance and will highlight problem areas.

## Mains relining

As water mains become old and reach the end of their useful lives, their performance diminishes gradually, resulting in high maintenance costs, deterioration of water quality, loss of hydraulic capacity, and a significant increase in customer complaints. Cleaning and lining of a poorly performing water main will decrease customer complaints and will improve water quality, flow, and pressure significantly. This will improve the long-term performance of the pipe and improve the reliability of the system. Rehabilitation of water mains using cleaning and lining results in significant cost savings compared to replacement. In North America, most of the water main rehabilitation is conducted using cement-mortar lining. Alternatives to cement-mortar lining of water mains are epoxy lining and polyurethane lining.

The Water Research Foundation (WRF 2015) with WERF and USEPA produced guidelines for water main inspection, repairs and maintenance. Chapter 6 is titled "Pipe lining system selection and design".

In the United Kingdom, epoxy has been used as the preferred lining material in rehabilitation of water pipelines. In the last few years, however, polyurethane has become the most widely used lining material in the UK. WRF (2010) reports results of a series of tests.

The impact of cement-mortar material on alkalinity in general terms was the same for all four test waters increasing it to 600 mg/L as CaCO<sub>3</sub> and then stabilising at 100 mg/L after day 19 of the test. The background alkalinity of the test waters was 35 mg/L.

The pH after the first day in contact with the cement mortar was 12.4. After 30 days in contact with the cement mortar and nine changes of water, the pH was 11.5.

Increased levels of calcium were measured over a 14-day period, after which calcium stabilised and remained at 7 to 9 mg/L as calcium, slightly below the background concentration of 11.5 mg/L.

Aluminium increased from day 1 to 9, then decreased significantly at day 11, probably due to a lower contact time of two days. The concentrations of aluminium exceeded the drinking water secondary maximum contaminant level of 0.2 mg/L for the first nine days of the test.

Chromium concentrations increased to 0.07 mg/L in 24 hours, but decreased significantly on day 9. Cement-mortar lining increased consumption of chlorine. The total solids concentrations increased up to 1500 mg/L on the first day and declined substantially after day 9.

In the presence of polyurethane, the pH was reduced from 8 to about 6. The pH drop was observed within 24 hours and persisted for 30 days. Polyurethane consumed chlorine. The consumption rate decreased over time, but still persisted at the end of 30 days of testing.

Organic carbon (TOC) was leached from polyurethane, with a greater amount leached in the presence of chlorine than in its absence. Leached total organic carbon reacted with free chlorine to form up to 30 µg/L of five regulated haloacetic acids (HAA5), but no trihalomethanes were detected; traces of chlorophenyl isocyanate were detected. The low pH of 6 would favour HAA5 formation over THM formation. None of the THM or HAA5 concentrations exceeded the drinking water standard of 80 µg/L and 60 µg/L, respectively. Weak to moderate odour intensities were released from the polyurethane and it persisted for the 30 days of the study.

Epoxy exposed to each of the three water types produced significant concentrations of TOC (3.5 to 6.3 mg/L) during the first 24 hours of exposure to water. By the second 24-hour exposure period the TOC decreased substantially. By the end of the 30 days, each of the water types exposed to epoxy had TOC present in concentrations between 0.5 and 1.7 mg/L, with chlorinated water having the highest TOC concentration.

Epoxy reduced the concentrations of chlorine. Mature pipe samples lined with epoxy also reduced the disinfectant residual concentrations.

Water exposed to epoxy showed some increase in the THM and HAA5 concentrations, but none of these increases exceeded the drinking water standards. The increases in THM and HAA5 concentrations were greatest in the chlorinated water. Bisphenol A was detected in substantial concentrations (22 to 33 µg/L) in all three water types exposed to epoxy. Concentrations were greatest during the initial 24 hours and were highest in both chlorinated and chloraminated waters. Bisphenol A decreased significantly by day 4, but trace concentrations were still detected on both day 9 and 14. No other SVOCs were detected in the samples.

### 16.3.3 Maintenance of disinfection residual

Most water supplies in New Zealand maintain a residual of free available chlorine throughout their distribution system. This is generally acknowledged to offer a good initial kill of most bacteria and viruses, and a long-lasting residual able to continue disinfecting within the distribution system, which helps limit regrowth, and to assist in countering any low level microbiological contamination. However, most contamination events in the distribution system will probably be too large for low levels of FAC to deal with; most ingress is likely to be as a result of a mains break or serious backflow. Therefore a major benefit of maintaining FAC is that it acts as an indicator of system security as large/sudden changes in FAC residuals would indicate ingress or

contamination of some kind. Regrowth of organisms in the distribution system is discussed in WHO (2003, 2004).

The DWSNZ specify requirements for sampling of *E. coli* and free available chlorine levels within each distribution zone. In most cases there is only one point where chlorine is dosed, usually at the treatment plant. If the distribution zone covers an extensive area or is an area of elongated shape, a high chlorine residual may be needed near the plant in order to get the required residual at the most remote locations. Alternatively, supplementary chlorination can be installed to boost the residual at strategic points in the network.

Free available chlorine levels in the network are typically in the range 0.2 to 1.0 mg/L. Higher concentrations are resisted due to cost and taste and odour concerns. Free available chlorine (FAC) has a noticeable flavour that increases with concentration. Most taste and odour complaints relate to the formation of inorganic and organic chlorine compounds, often in relation to pipes with biofilms, deposits, or corrosion products, particularly when the water temperature increases. Also refer to Chapter 18: Aesthetic Considerations.

In addition to biofilm, the rate of loss of the chlorine residual after the dosing point also depends on:

- the retention time
- compounds that react slowly with chlorine remaining in the water following treatment
- contaminants entering the water in the distribution system
- the state of the water mains
- water temperature.

This is why some *E. coli* monitoring is still required even when the water contains FAC.

The DWSNZ (section 4.4.6 for compliance criteria 6A and 6B, and section 4.4.7.5 for compliance criteria 7A and 7B) require that remedial action be taken in the case of *E. coli* contamination of a drinking-water supply distribution zone. These actions include doing an *E. coli* count, increasing disinfection, undertaking a sanitary survey, target sampling and informing the drinking water assessor or other Ministry of Health designated officer.

## 16.3.4 Barriers against recontamination during maintenance

Water leaving a well-designed and operated treatment plant will contain very few micro-organisms. Therefore, any significant microbiological contamination of the drinking-water received by the consumer will probably have occurred in the distribution system.

The main barrier against the recontamination of water supplies in the distribution system is a sound, well-designed maintenance regime. It is important that operational procedures cover all aspects of the maintenance of water quality from the treatment plant, through the distribution system, to the consumer's tap. These should be addressed in the WSPs, along with possible remedial actions for when problems have been identified. See section 16.2.6 for possible issues related leakage and pressure problems.

Operational procedures (work instructions if part of a quality management system) should be produced covering (refer section 16.3.2):

- new mains disinfection, mains cleaning and repairs
- backflow prevention
- overcoming quality problems induced by the distribution system (eg, dead ends, pressure variations, build-up of corrosion products)
- updating as-built drawings
- service reservoir maintenance and operation
- consumer complaints relating to the quantity and quality of drinking-water (details and action taken)
- leak detection, see NZWWA (2002) and WHO (2001).

Maintenance programmes should include the recording of the time and type of various repairs and cleaning options used.

Staff working on water reticulation systems and their equipment offer potential sources of contamination. The following general guidelines are recommended most strongly to minimise these risks:

- operators and maintenance workers should work only on the water supply, and not alternate between water supply and sewerage
- staff and contractors need to be trained to use the appropriate hygienic practices at courses such as run by the Water ITO. Regular refresher courses are desirable
- vehicles and tools used on water supply work must be kept totally separate from those used in sewerage work
- a high standard of cleanliness must be adhered to in maintenance vehicle interiors
- ablution facilities must be available, and used
- operators and maintenance workers should report any gastrointestinal illness, have faecal specimens taken for analysis at the outbreak of such illness, and be placed on work not involving handling water supply system components until a medical certificate of clearance is obtained following such illness
- prior to employment on the water supply system, and on an annual basis thereafter, or following overseas travel to countries with a significant level of endemic waterborne disease, operators and maintenance workers should obtain a medical clearance from being carriers of potentially waterborne disease. The clearance required under this and the previous guideline is likely to be obtained from a laboratory evaluation of faecal specimens taken over three consecutive days and tested for the presence of *Shigella*, *Salmonella*, *Campylobacter*, hepatitis A virus, and *Giardia*, *Cryptosporidium* spp or antibodies



- the Water Supplies Protection Regulations (1961) required the disinfection of new mains and mains repairs to the satisfaction of the Medical Officer of Health in situations where significant contamination potential exists. Under the HDWAA, this is now to be covered in the water supplier's WSP. Drinking-water assessors must approve WSPs
- for further guidance, refer to the MoH PHRMP Guides (see References); for example, Appendix 1 in Guide D3 discusses Good Hygiene Practices for Staff Working on Drinking Water Supplies, and Appendix 2 covers Cleaning and Disinfection of Mains.

Chapter 5 (Precautions during Construction and Repairs) in WHO (2004) states:

Engineering work on distribution systems presents risks of widespread contamination of water supplies. The risks depend on factors such as the degree of pollution at the construction or repair site, the method of construction or repair, the ability to contain potential contamination by valving and, most importantly, the cleanliness of personnel, their working practices and the materials employed. The following activities may present risks of contamination with pathogenic micro-organisms:

- construction of new pipework or the abandonment of existing pipework
- renovation work using either structural or non-structural linings, such as polyethylene slipliners or spray-on coatings
- repairs, either emergency or planned, that involve pressure loss or breaking into the inside of a pipe
- reconnecting a water main after it has been taken out of service for an extended period.

See also section 8 in WHO (2014). Section 8.1.8 discusses making connections to the mains. Section 8.1.10 itemises procedures that need to be addressed in standard operating procedures or water safety plans for repairing mains. Section 8.1.11 covers construction of new mains.

The USEPA (2002) prepared a paper on *New or Repaired Water Mains*. It refers to ANSI/AWWA Standards 600-606 which address pipe installation procedures, as well as guidelines on inspection, trench construction, pipe installation, joint assembly, flushing, pressure and leakage testing. It also refers to AWWA Standard C651 for Disinfecting Water Mains.

Emergency repairs present the greatest risks: locating valves, dealing with consumers and traffic, the presence of adjacent services and the need to restore an essential supply all create difficulties when the location and timing are unplanned. Minimising the risks arising from both emergency and planned engineering work depends on:

- having documented protocols
- adopting general precautionary working practices
- using health criteria to select personnel
- implementing effective procedures for cleaning and disinfection
- assessing the risks and monitoring the effects of both planned and emergency engineering work.

Earthquakes can cause breakages in the distribution system, leading to contamination. In the month following the February 2011 Christchurch earthquake, over 5000 samples were collected for *E. coli* testing; 155 contained *E. coli*. Mapping the results indicated the areas with the greatest need for flushing.

WHO (2004) addresses each of the above topics. Water suppliers will find those 14 pages will provide an excellent basis for preparing their water mains installation and repair manual. WHO (2011a) provides technical notes covering a range of emergency situations. Excess pressure can lead to mains breaks. The breakage rate needs to be monitored to find out if it is excessive. A survey conducted in North America reported an average of seven breaks per 100 km of water main per year; in Australia in 2011–2012, the rate was 13 breaks per 100 km of water main; reported in WHO (2014).

Earlier, three cities in the Auckland region proposed a code of practice (Utting et al 1993). This has not eventuated yet. They used two main reports in preparing their paper: AWWA (1990) and WAA (1988).

They considered that the code should cover three situations, and they then offered some suggestions:

- new mains
- repairs maintained under positive pressure
- repairs where there is pressure loss or full draining of the line.

## New mains

- Chain of cleanliness established for all equipment and fittings prior to use.
- Thoroughly flush or swab mains to remove debris.
- Disinfect to achieve a minimum chlorine C.t value of 5,000 mg/L.minutes.
- Flush chlorinated water to waste, with prior neutralisation and discharge approvals if required.
- Sample for *E. coli* at at least two locations.
- Commission mains when results <1 *E. coli* per 100 mL.

## Repairs maintained under positive pressure

(Generally limited to small diameter pipes and wrap-around clamps.)

- Chain of cleanliness applied to repair equipment and fittings.
- Good standard of work and equipment.

## Repairs where pressure is lost or line drained

- Chain of cleanliness applied for all equipment and fittings prior to use.
- Isolate the section of main and drain (or pump) the water from the break.
- Excavate below the main to create a sump that can be dewatered.
- Apply chlorine solution to trench walls, pipe and fittings.

- If contaminated water is likely, apply chlorine to a C.t value of 500 mg/L.minutes, or notify consumers to boil water,<sup>1</sup> or supply drinking-water.
- Thoroughly flush main and affected consumer connections before restoring service.
- Sample for *E. coli* randomly for low risk situations, and mandatory for all other cases.

WSTB (2006) includes: the following summary shows results of a survey of distribution system workers at three different utilities (eastern US, western US, and western Canada) on the potential for external contamination to occur during water main repair and replacement activities. Given that the average number of water main repairs a year for a single utility ranges from 66 to 901 (which corresponds to 7.9–35.6 repairs per 100 miles of pipe per year), it is clear that exposure of the distribution system to contamination during repair is an inescapable reality.

| Activity   | Responses (%) from workers, 3 different utilities (A, B, C) |     |    |                  |    |    |
|--|---|-----|----|------------------|----|----|
|  | Occurs often  |     |    | Occurs sometimes |    |    |
|  | A   | B   | C  | A                | B  | C  |
| Broken service line fills trench during installation | 46  | 75  | 56 | 39               | 25 | 33 |
| Pipe gets dirty during storage before installation   | 53  | 75  | 22 | 43               | 25 | 33 |
| Trench dirt gets into pipe during installation       | 24  | 100 | 39 | 37               | 0  | 44 |
| Rainwater fills trench during installation           | 20  | 25  | 5  | 60               | 75 | 83 |
| Street runoff gets into pipe before installation     | 30  | 0   | 11 | 61               | 38 | 67 |
| Pipe is delivered dirty                              | 4   | 25  | 17 | 33               | 63 | 22 |
| Trash gets into pipe before installation             | 24  | 0   | 0  | 56               | 50 | 11 |
| Vandalism occurs at the site                         | 15  | 0   | 0  | 35               | 0  | 5  |
| Animals get into pipe before installation            | 0   | 0   | 0  | 11               | 0  | 11 |

Source: Reprinted, with permission, from Pierson et al 2002. © 2002 by American Water Works Association.

DWI (2015) includes the statement: *By some estimates, there are over 700 water main breaks in the United States every day that require repair.* This document states that as part of the Risk Management Strategy, four categories of breaks and responses can be developed and summarised.

- Type 1: positive pressure maintained during excavation and repair
- Type 2: positive pressure maintained during excavation, followed by controlled shut down for repair
- Type 3: loss of pressure at break site/possible local depressurisation
- Type 4: catastrophic failure, loss of pressure at break site, and widespread depressurisation.

They then present their Table ES which tabulates responses for different main break types. This excellent summary was developed by the UK Drinking Water Inspectorate in conjunction with the Water Research Foundation (previously AWWA Research Foundation in the US).

<sup>1</sup> Chapter 6 includes an Appendix: Boil Water Notices.

A study of 69 incidents in five water supplies in Sweden found that a significantly elevated risk of gastrointestinal illness, especially vomiting and AGI, was linked to incidents in the drinking water distribution with children in the 2–5 year age group at the highest risk. The results give support to the hypothesis that pathogens causing gastrointestinal illness originate from an external source, such as sewage, as an elevated risk of vomiting and AGI was associated with drinking water pipelines being on the same level as sewage pipes in trenches. In contrast to other studies, this study showed that there was still an elevated risk of gastrointestinal illness after flushing was used as a safety measure. Additional safety measures should therefore be considered as current safety measures and routines may not be sufficient for reducing the risk of gastrointestinal illness (Säve-Söderbergh et al 2017).

## 16.4 Aesthetic considerations

There are many constituents that affect the taste, odour, colour, clarity or general appearance of the water. Some of these are listed in Table 2.5 of DWSNZ. Chapter 18 of the Guidelines discusses this topic in more detail. Datasheets have been prepared for a large number.

In some circumstances, the aesthetic quality of the water can deteriorate in the distribution system. See section 16.2.6 for a discussion on chemicals that can impart tastes and odours by permeation through or leaching from the pipework.

The impact and detection of aesthetic problems are detectable by consumers, whereas the more serious chemical and microbiological contaminants are not. Aesthetic considerations are covered in more detail in Chapter 18.

### 16.4.1 Wholesomeness

Note that the HDWAA states in 69W “Every water supplier must take reasonable steps to ensure that the drinking water supplied by that drinking water supplier is wholesome”. And in 69G, “wholesome, in relation to drinking water, means:

- a) being potable, and
- b) not containing or exhibiting any determinand in an amount that exceeds the value stated in the guideline values for aesthetic determinands in the DWSNZ ...”.

Aesthetically poor water quality in the distribution system can be caused by a number of factors. In some cases the quality of the water can deteriorate to the point where it affects compliance with the DWSNZ.

## Construction causes

The installation of pipes should maintain cleanliness, particularly from plugs of mud or similar which will be detected by customers as cloudy water. Some construction materials can also impart taste and odour to water, such as solvent odours from some reservoir linings, and these may react with chlorine to impart tastes and odours. Plastic pipes should not be laid in land contaminated by chemicals.

## Hydraulic causes

Water that is retained in the distribution system may go stale. The reasons for water standing in sections of water pipelines include: small areas fed from a large service reservoir or tank, large-sized dead end mains for fire flows with very low flows, large-sized mains installed for future growth but supplying only a few properties, and dead spots in ring mains (a balance point of zero flow under most flow conditions). The most common solution to stale water is to flush the main regularly, weekly is normally adequate.

Stale water can affect water quality in the following ways:

- Residual chlorine will dissipate with time, leading to the loss of consumer protection.
- Chlorine may form chloramines with any organics or ammonia present. There is a link between water with elevated colour levels and trichloramine formation at low pH. Complaints relating to trichloramine (albeit rare) will usually be of excessive chlorine smells because the trichloramine breaks down on release to air, giving off free chlorine. The remedies to these problems are to remove more of the organics in the treatment process and/or flush water to waste at frequent intervals, less than weekly.
- Harmful disinfection by-products such as THMs and HAAs can form with prolonged exposure of treated water to free chlorine. This issue is discussed separately in Chapters 10 and 15.
- Alkalinity and pH levels may increase due to the dissolving of cement based pipe lining. This is a particular problem with aggressive water and asbestos cement and concrete lined steel or ductile iron pipes. This problem eases with time (a few years) but initially can be very severe: pH levels may exceed pH 10. This can lead to reports of 'green coffee', a drying or burning sensation in the mouth, and an absence of lather when shaving, etc.

Sediments, in some cases including precipitates of alum floc, iron, and manganese, or fine sand from hydrated lime or groundwater, can collect in the system, only to be dislodged by reverse flows or higher flows (for example fire flows). Regular flushing will help to control this.

## Chemical causes

Water quality may be affected by interactions with the reticulation pipework. These interactions may be divided into those with soft (aggressive) water and those with hard water. The chemistry of water is described in Chapter 10. Plastic pipes and fittings should be those approved for water supply use, see section 16.2.6.

## Soft, aggressive water

The most direct result of poor water chemistry is corrosion of the pipe materials, particularly the metal components. Consumers easily notice oxidised iron (eg, from the pipe in Figure 16.5) and copper products, but lead also corrodes out of some fittings. In severe cases the concentration of the corrosion products can exceed the MAVs in the DWSNZ. This is discussed further in Chapter 10. Many corrosion issues in water supply are discussed in AWWA (1990) and AWWA (1996). Corrosion products also reduce the water flow through the distribution system.

**Figure 16.5: Example of corroded water pipe**



The problems will be worsened by unstable or inappropriate water pH. A stable pH is essential for developing and maintaining effective passivating layers on metallic pipe surfaces. The pH of water leaving treatment will normally be controlled. The pH of the water can change in the distribution system, such as when carbon dioxide is evolved from some groundwaters, or if the water is rechlorinated.

Consumers detect corrosion products as follows:

- Rust from cast iron water mains is normally dark red to black and may be any size from several millimetres to a very fine sediment. Iron typically appears as orange/brown rusty stains, streaks or spots on laundry. Stains from taps also appear on baths and sinks. Iron can clog pipes and damage the internal parts of appliances. Iron can also appear after the protective zinc layer has corroded from galvanised steel pipework.

- The concentration of copper in the water can increase to levels that cause a bitter metallic taste. Blue-green water or bluish cloudy water may discharge from cold taps. There may also be a build-up of crystals or blue stains on basins or the back of the toilet bowl. In some cases the corrosion will damage household plumbing, including hot water cylinders. Copper corrosion mechanisms can be complex and the causes (apart from simple dissolution due to carbon dioxide) are generally difficult to isolate. Copper materials (including brasses and bronzes) are affected by low pH water and/or water with high sulphate contents; as a general rule, the sulphate level should not exceed twice the bicarbonate level.
- Asbestos cement pipe corrosion will lift the pH for many years and release fibres into the water. However the fibre release into drinking-water is not readily detectable by consumers, and is not a health problem. For further information, see NZWWA (2001), DWI (2002) and datasheet.

## Hard water

Hard water is not common in New Zealand. Examples of major (city) supplies with fairly hard water are the groundwater supplies to Napier, Hastings, Wanganui, Gisborne's Waipaoa River supply, and parts of Palmerston North.

Hardness may lead to the build-up of calcium carbonate in pipelines. The deposition of scale in household kettles from temporary hardness is more common. Clothes washed in hard water may look dingy and feel harsh and scratchy. Dishes and glasses may be spotted when dry. Hard water may cause a film on glass shower doors, shower walls, bathtubs, sinks, faucets, etc. More soap is needed for cleaning and hair washed in hard water may feel sticky and look dull.

Hardness can be reduced by treatment but this is unusual on large New Zealand supplies. Hard water has few of the problems with corrosion by-products experienced in soft water supplies. Hardness can be a problem in high pressure boilers.

## Silica

Silica is the second most abundant mineral on Earth. High silica levels may cause post treatment precipitates that may form plaque deposits inside pipework under certain conditions. Under certain conditions it can distil across in steam generators staining (for example) vehicle windows with a milky film; otherwise its main problem is in boilers.

## Temperature

As the water temperature increases, corrosion rates increase, biofilm growth rates increase, chemicals can leach more rapidly from materials used in the pipework and plumbing, tastes and odours may become more detectable, and residual chlorine dissipates more quickly. Apart from natural seasonal effects, the water temperature can increase in service reservoirs (particularly if unburied, and if the water sits there for a few days), and in water mains and service pipes that are too close to the surface (or even laid on the ground!). People generally prefer to drink cool water. Water in a low-use reservoir in Auckland has been measured at about 30°C!

## Biofilms

A biofilm is a collection of organic and inorganic, living and dead material, attached to a surface. It may be a complete film, or, more commonly in water systems, it is a small patch on a pipe surface. Biofilms in drinking-water pipe networks can be responsible for a wide range of water quality and operational problems. Biofilms contribute to loss of distribution system disinfectant residuals, increased bacterial levels, reduction of dissolved oxygen, taste and odour changes, red or black water problems due to iron- or sulfate-reducing bacteria, microbial influenced corrosion, hydraulic roughness and reduced material life. Micro-organisms in biofilms can include bacteria (including coccoid [round], rod-shaped, filamentous and appendaged bacteria), fungi and higher organisms, such as nematodes, larvae and crustaceans. Although viruses and *Cryptosporidium* do not grow in a biofilm, they can attach to biofilms after a contamination event. See WHO (2003, Chapter 10) for further information.

Biofilms (Figure 16.6), or slimes, can become established in static areas, sediments, corrosion tubercles and storage tanks. This may occur in the network or in the customer's pipework and hoses. The biofilm may host pathogens, general heterotrophic micro-organisms (that can reach high population densities in the summer) with uncertain health-effects, and biologically oxidised precipitates of substances such as iron and manganese, and may lead to taste and odour. Where anaerobic activity develops, odorous sulphur compounds such as hydrogen sulphide can be produced. Biofilms are therefore very undesirable; they can even affect the flow.

Where nutrient levels are very low and the water is chemically stable, biofilms should only occur as a result of inadequate chlorine residual. However, if significant biofilms develop on pipe walls, then even a high chlorine residual will not effectively penetrate the biofilm. In these cases it will be necessary to flush the lines regularly at high velocity to shear off the biofilm and apply chlorine at higher concentrations. The pH value also is important in dislodging biofilm as detachment can occur more rapidly at higher pH values.

In extreme cases, air scouring, mechanical scouring (pigging) or swabbing may be needed to remove the biofilm; see WSTB (2006) for more details. WRF (2015b) provides an in depth discussion on the removal of manganese from water mains.



**Figure 16.6: Structure of a biofilm**

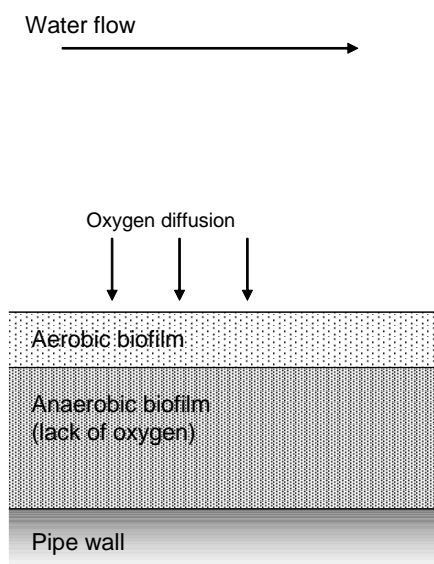

In the longer term, the growth of biofilms in corrosion tubercles, etc can be reduced by the manipulation of water chemistry to reduce corrosivity. Microbial nutrients should be limited as far as possible. Ammonia can be a marked contributor to biofilms, partly due to its reaction with chlorine. Organic carbon, nitrogen, phosphorus, sulphur compounds, trace metals and salts can all contribute to biofilm growth.

Most information about the microbiology of drinking water is obtained by examining water samples taken from taps. This type of monitoring is not representative of attached microbial communities, and it is known that biofilms represent more than 95 percent of the biomass in the distribution system. Extensive biofilms can exist even in supplies that have very low HPC or coliform levels in tap water. This can be because the biofilm does not readily slough off, or because the biofilm microorganisms are difficult to culture on commonly used media. Douterelo et al (2015) describe a study of biofilm formation and composition.

WRF (2015a) describes sampling and analytical techniques for examining biofilms. Characterisation of sampled biofilms has moved beyond simple quantification of biomass and metabolic activity to high-throughput molecular methods for identifying microbial composition which do not depend on the ability to grow an organism in culture.

## 16.4.2 Consumer complaints

Things can go wrong in any system. If they do, it is often customers who are the first to notice, so an effective way to capture information, respond to complaints, mitigate issues, and collect data so that overall service and reliability is improved should be a documented and monitored procedure. This should be covered in the water supplier's policy statement, and addressed where applicable in more detail in the WSP. See Chapter 18: Aesthetic Considerations.

The obligations of the water supplier to customers should be laid out in a customer charter, on the supplier website, or through a similar medium. These should include response times, prioritising complaints, and where the responsibility of the water supplier stops and starts.

Staff responsible for distribution will have to:

- investigate consumer complaints within an agreed timeframe. These typically relate to water pressure, volume, seepage, leakage, taste/odour and discolouration
- perform field tests as necessary
- advise the consumer of possible solutions to the problem
- fix the problem (where this is practical and within the terms of the customer contract)
- record the complaint and subsequent action on a register so performance measures and system reliability information can be assessed
- periodically examine and analyse the list of complaints for any discernible trends that may require remedy at the system/asset management level.

Performance measures include the general consumer complaint rate, frequency of repeat callouts, the justified consumer complaint rate, the response time to consumer complaints, and recurrence frequency.

## References

American Water Works Association Research Foundation. 1996. *Internal Corrosion of Water Distribution Systems*. Denver CO: AWWA and AWWA Research Foundation.

ANSI/AWWA. 2011. *Disinfection of Water Storage Facilities*. ANSI/AWWA Standard C652-11. Denver CO: American Water Works Association.

ANSI/AWWA. 2013. *Disinfection of Water Treatment Plants*. ANSI/AWWA Standard C653-13. Denver CO: American Water Works Association.

ANSI/AWWA. 2009. *Distribution Systems Operation and Management*. ANSI/AWWA Standard G200-09. Denver CO: American Water Works Association.

ANSI/AWWA. 2005. *Disinfecting Water Mains*. ANSI/AWWA Standard C651-05. Denver CO: American Water Works Association.

AWWA. 1989. *Steel Pipe: A guide for design and installation* (4th edition). AWWA Manual M11. Denver CO: American Water Works Association.

AWWA. 1990. *Recommended Practice for Backflow Prevention and Cross-connection Control* (2nd edition). AWWA Manual M14. Denver CO: American Water Works Association.

AWWA. 1990. *Water Quality and Treatment* (4th edition). McGraw-Hill Inc.

AWWA. 1995. *Concrete Pressure Pipe* (2nd edition). AWWA Manual M9. Denver CO: American Water Works Association.

- AWWA. 1996. *Fiberglass Pipe Design* (1st edition). AWWA Manual M45. Denver CO: American Water Works Association.
- AWWA. 1998. *Steel Water Storage Tanks* (1st edition). AWWA Manual M42. Denver CO: American Water Works Association.
- AWWA. 2001. *Rehabilitation of Water Mains* (2nd edition). AWWA Manual M28. Denver CO: American Water Works Association.
- AWWA. 2002. *PVC Pipe: Design and Installation* (2nd edition). AWWA Manual M23. Denver CO: American Water Works Association.
- AWWA. 2003. *Ductile-iron Pipe and Fittings* (2nd edition). AWWA Manual M41. Denver CO: American Water Works Association.
- AWWA. 2005. *Water Quality in the Distribution System*. AWWA Trends in Water Series. Denver CO: American Water Works Association.
- AS/NZS 4020. 2002. *Testing of Products for Use in Contact with Drinking Water*.
- AS/NZS 3500.1. 2003. *Plumbing and Drainage*. Part 1 – Water Services.
- BECA. 2010. Drinking Water Standards New Zealand Cost Benefit Analysis – Engineering Input. Prepared for the Ministry of Health by CH2M Beca. 103 pp. [http://www.health.govt.nz/system/files/documents/publications/drinking-water-standards-nz-cost-benefit-analysis\\_0.pdf](http://www.health.govt.nz/system/files/documents/publications/drinking-water-standards-nz-cost-benefit-analysis_0.pdf).
- DoE. 1990. *Effect of Water Supply Distribution Systems Survey on Organic Contaminants in Potable Water* (HET 9155). Final report to the Department of the Environment DoE 2215-M/1 Report No DWI0032. <http://www.fwr.org/dwpage4.htm>.
- Douterelo I, Jackson M, Solomon C, et al. 2015. Microbial analysis of in situ biofilm formation in drinking water distribution systems: implications for monitoring and control of drinking water quality. *Applied Microbiology and Biotechnology*, DOI 10.1007/s00253-015-7155-3.
- Drinking Water Inspectorate (DWI). 2011. *List of Approved Products for Use in Public Water Supply in the United Kingdom*. London: Department for Environment, Food and Rural Affairs. See [www.dwi.gov.uk](http://www.dwi.gov.uk) or <http://dwi.defra.gov.uk/drinking-water-products/approved-products/soslistcurrent.pdf> (regularly updated).
- Durand ML. 2005. *Disinfectants and Plumbing Materials: Effects on sensory and chemical characteristics of drinking water*. Thesis submitted to the faculty of the Virginia Polytechnic Institute and State University in partial fulfilment of the requirements for the degree of Master of Science in Environmental Engineering. 90 pp. <http://scholar.lib.vt.edu/theses/available/etd-11302005-121845/unrestricted/ThesisMoniqueDurand2.pdf>.
- Durand ML, Dietrich AM. 2007. Contributions of silane cross-linked PEX pipe to chemical/solvent odours in drinking water. *Water Science and Technol* 55(5): 153–60.
- DWI. 2002. *Asbestos Cement Drinking Water Pipes and Possible Health Risks Review for DWI*. 10 pp. [http://dwi.defra.gov.uk/research/completed-research/reports/DWI70\\_2\\_135\\_asbestos%20cement%20pipes.pdf](http://dwi.defra.gov.uk/research/completed-research/reports/DWI70_2_135_asbestos%20cement%20pipes.pdf).

- DWI. 2002a. *Future Regulatory Parameters: Implications for the UK*. Final report for Phase 1. DWI 70/2/145. 105 pp. [http://dwi.defra.gov.uk/research/completed-research/reports/DWI70\\_2\\_145\\_para%20implications.pdf](http://dwi.defra.gov.uk/research/completed-research/reports/DWI70_2_145_para%20implications.pdf).
- DWI. 2007. *The Long Term Migration of Substances from In-situ Applied Epoxy Resin Coatings*. 100 pp. DWI 7369/1. <http://dwi.defra.gov.uk/research/completed-research/reports/0850.pdf>.
- DWI. 2008. *A Review of Research on Pressure Fluctuations in Drinking Water Distribution Systems and Consideration and Identification of Potential Risks of such Events Occurring in UK Distribution Systems* (WT1205 / DWI 70/2/220). 52 pp. [http://dwi.defra.gov.uk/research/completed-research/reports/DWI70\\_2\\_220.pdf](http://dwi.defra.gov.uk/research/completed-research/reports/DWI70_2_220.pdf).
- DWI. 2011. *Investigation of Instances of Low or Negative Pressures in UK Drinking Water Systems: Final report*. Defra Ref: WT1243/DWI 70/2/245. 95 pp. <http://dwi.defra.gov.uk/research/completed-research/2000today.htm>.
- DWI. 2011a. *An Investigation of Leaching from Flexible Rising Mains Leading from Borehole Pumps*. DWI 8102/3. 175 pp. <http://dwi.defra.gov.uk/research/completed-research/2000today.htm>.
- DWI. 2015. *Effective Microbial Control Strategies for Main Breaks and Depressurization*. DWI 70/2/261. Executive summary: <http://dwi.defra.gov.uk/research/completed-research/reports/DWI70-2-261exsum.pdf>.
- DWI. 2016. *Brass Fittings: A source of lead and nickel in drinking water*. Stage 3 long term testing, April 2015 to March 2016. Executive summary. UK Water Industry Research Limited. 3 pp. <http://dwi.defra.gov.uk/research/completed-research/reports/DWI70-2-309exsum.pdf>.
- DWI. 2016a. *Assessing the Effect of Water Meter Installation on Exposure to Lead in Water*. Report Reference: DEFRA10511.03. 121 pp. <http://dwi.defra.gov.uk/research/completed-research/reports/DWI70-2-282.pdf>.
- Edwards M. 2004. Controlling corrosion in drinking water distribution systems: a grand challenge for the 21st century. *Water Science and Technol* 49(2): 1–8.
- Glaza EC, Park JK. 1992. Permeation of organic contaminants through gasketed pipe joints. *J AWWA* 84(7): 92–100.
- Health Canada. 2009. *Guidance on Controlling Corrosion in Drinking Water Distribution Systems*. Water, Air and Climate Change Bureau, Healthy Environments and Consumer Safety Branch, Health Canada, Ottawa, Ontario. (Catalogue No. H128-1/09-595E). 92 pp. <https://www.canada.ca/content/dam/canada/health-canada/migration/healthy-canadians/publications/healthy-living-vie-saine/water-corrosion-eau/alt/water-corrosion-eau-eng.pdf>.
- Holsen TM, Park JK, Jenkins D, et al. 1991. Contamination of potable water by permeation of plastic pipe. *JAWWA* 83(8): 53–6.
- Kleiner Y. 1998. *Risk Factors in Water Distribution Systems*. British Columbia Water and Waste Association, 26th Annual Conference, Whistler, BC, Canada.

Master Plumbers. 2018. *New Zealand Backflow Testing Standard: Field testing of backflow prevention devices and verification of air gaps*. Master Plumbers, Gasfitters and Drainlayers NZ Inc and Water New Zealand. 54 pp.

The New Zealand Ministry of Health's Guides for drinking-water supplies can be accessed as Word documents on the Ministry of Health website:

<http://www.health.govt.nz/water> then select publications and Water Safety Plans.

Ministry of Health. *Public Health Risk Management Plan Guide PHRMP Ref: P2. Treatment Processes – Water Transmission*. Wellington: Ministry of Health.

Ministry of Health. *Public Health Risk Management Plan Guide PHRMP Ref: P10. Treatment Processes – Pump Operation*. Wellington: Ministry of Health.

Ministry of Health. *Public Health Risk Management Plan Guide PHRMP Ref: D1. Distribution System – Post-Treatment Storage*. Wellington: Ministry of Health.

Ministry of Health. *Public Health Risk Management Plan Guide PHRMP Ref: D2.1. Distribution System – Construction Materials*. Wellington: Ministry of Health.

Ministry of Health. *Public Health Risk Management Plan Guide PHRMP Ref: D2.2. Distribution System – System Pressure*. Wellington: Ministry of Health.

Ministry of Health. *Public Health Risk Management Plan Guide PHRMP Ref: D2.3. Distribution System – Operation*. Wellington: Ministry of Health.

Ministry of Health. *Public Health Risk Management Plan Guide PHRMP Ref: D2.4. Distribution System – Backflow Prevention*. Wellington: Ministry of Health.

Ministry of Health/Otago Polytechnic. 2002. *National Diploma in Drinking-Water Assessment. Tutor Notes and Home Assignment for Unit Standard 18458 – Drinking Water Supply Reticulation Systems*. Wellington: Ministry of Health.

Ministry of Health/Otago Polytechnic. 2002. *National Diploma in Drinking Water Assessment. Tutor Notes and Home Assignment for Unit Standard 18459 – Describe Drinking Water Reticulation System Management and Management of Critical Points*. Wellington: Ministry of Health.

Ministry of Health. 2005. *Drinking-water Standards for New Zealand (revised 2008)*. Wellington: Ministry of Health.

New Zealand Building Act (BA). 2004. *New Zealand Building Code (Clause G12/AS1)*. Approved document for *NZ Building Code, Water Supplies*, Clause G12 (2nd edition), 2001. Building Industry Authority. See <http://www.dbh.govt.nz/UserFiles/File/Publications/Building/Compliance-documents/G12-water-supplies-3rd-edition-amendment-8-rp.pdf>.

NSF International, 148 Avenue. Grandchamp 1150, Brussels, Belgium. Email: [brussels@nsf.org](mailto:brussels@nsf.org). Tel: +32 2 7713654. Or look at <http://www.nsf.org/>.

NZWWA. 2001. *New Zealand Asbestos Cement Water Main Manual*. Wellington: New Zealand Water and Wastes Association.

NZWWA. 2002. *Benchmarking of Water Losses in New Zealand*. Wellington: New Zealand Water and Wastes Association.

NZWWA. 2006. *Backflow Prevention for Drinking Water Suppliers, Code of Practice*. Wellington: Backflow Special Interest Group, New Zealand Water and Wastes Association. Since revised, see:

NZWWA. 2013. *Boundary Backflow Prevention for Drinking Water Suppliers*. 41 pp. Wellington: New Zealand Water and Wastes Association. <http://www.waternz.org.nz>.

Sadiki AI. 1998. A study of organotin level in Canadian drinking water distributed through PVC pipes. *Chemosphere* 38(7): 1541–8.

Säve-Söderbergh M, Bylund J, Malm A, et al. 2017. Gastrointestinal illness linked to incidents in drinking water distribution networks in Sweden. *Water Research* 122: 503–11.

Skjevrak I, Due A, Gjerstad KO, et al. 2003. Volatile organic components migrating from plastic pipes (HDPE, PEX and PVC) into drinking water. *Wat Res* 37(8): 1912–20.

Thompson C, Jenkins P. 1987. *Review of Water Industry Plastic Pipe Practices*. Denver CO: AWWARF.

Tomboulia P, Schweitzer L, Mullin K, et al. 2004. Materials used in drinking water distribution systems: contribution to taste-and-odor. *Water Science and Technology* 49(9): 219–26. Available on the Internet via <http://www2.oakland.edu/chemistry/faculty.cfm?ID=4616>.

USEPA. 2002. *Permeation and Leaching*. Prepared for US Environmental Protection Agency, Office of Ground Water and Drinking Water, Standards and Risk Management Division, Washington DC. Prepared by AWWA, with assistance from Economic and Engineering Services, Inc. The paper is available at the TCR website at: <http://water.epa.gov/lawsregs/rulesregs/sdwa/tcr/upload/permeationandleaching.pdf>.

USEPA. 2002a. *The Potential for Health Risks from Intrusion of Contaminants into the Distribution System from Pressure Transients*. Office of Ground Water and Drinking Water Distribution System Issue Paper. By M. LeChevalier et al. 20 pp. <http://water.epa.gov/lawsregs/rulesregs/sdwa/tcr/upload/thepotentialforhealthrisksfromintrusionofcontaminants.pdf>.

USEPA. 2002b. *New or Repaired Water Mains*. Office of Ground Water and Drinking Water Distribution System Issue Paper. 15 pp. <http://water.epa.gov/lawsregs/rulesregs/sdwa/tcr/upload/neworrepairedwatermains.pdf>.

USEPA. 2003. *Cross Connection Control Manual*. EPA 816-R-03-002. 52 pp, [http://water.epa.gov/infrastructure/drinkingwater/pws/crossconnectioncontrol/crossconnectioncontrol\\_manual.cfm](http://water.epa.gov/infrastructure/drinkingwater/pws/crossconnectioncontrol/crossconnectioncontrol_manual.cfm) or <http://www.epa.gov/safewater/pdfs/crossconnection/crossconnection.pdf>.

USEPA. 2006a. *Distribution System Indicators of Drinking Water Quality*. Total Coliform Rule Issue Paper. 100 pp. <http://www.epa.gov/safewater/disinfection/tcr/index.html>.

USEPA. 2006b. *Inorganic Contaminant Accumulation in Potable Water Distribution Systems*. Total Coliform Rule Issue Paper. 93 pp. <http://www.epa.gov/safewater/disinfection/tcr/index.html>.

Utting P, Taylor R, Urquhart T, et al. 1993. *Contamination, What Contamination?* Paper presented at the NZWWA Annual Conference.

Water Authorities Association. 1988. *Operational Guidelines for the Protection of Drinking Water Supplies*. United Kingdom.

*Water Supplies Protection Regulations (WSPR)*. 1961. Wellington: Ministry of Health.

Water UK. 2010. *Principles of Water Supply Hygiene Document*. Technical Guidance Notes 1–10. 17 pp.

<http://www.water.org.uk/home/policy/publications/archive/drinking-water/principles-of-water-supply-hygiene>.

WHO. 2001. *Leakage Management and Control: A best practice training manual*. WHO/SDE/WSH/01.1. World Health Organization. 169 pp. Available on the internet at: [http://www.who.int/water\\_sanitation\\_health/hygiene/om/leakage/en/index.html](http://www.who.int/water_sanitation_health/hygiene/om/leakage/en/index.html).

WHO. 2003. *Heterotrophic Plate Counts and Drinking-water Safety: The significance of HPCs for water quality and the human health*. Published on behalf of World Health Organization by IWA Publishing. 271 pp. Available on the internet at: [http://www.who.int/water\\_sanitation\\_health/dwq/hpc/en/index.html](http://www.who.int/water_sanitation_health/dwq/hpc/en/index.html).

WHO. 2004. *Guidelines for Drinking-water Quality* (3rd edition). Geneva: World Health Organization. Available at: [www.who.int/water\\_sanitation\\_health/dwq/gdwq3/en/print.html](http://www.who.int/water_sanitation_health/dwq/gdwq3/en/print.html) see also the addenda.

WHO. 2004. *Safe Piped Water: Managing microbial water quality in distribution systems*. 147 pp. Available at [http://www.who.int/water\\_sanitation\\_health/dwq/924156251X/en/index.html](http://www.who.int/water_sanitation_health/dwq/924156251X/en/index.html) and then select the chapter.

WHO. 2006. *Health Aspects of Plumbing*. Published jointly by the World Health Organization and the World Plumbing Council. ISBN 92 4 156318 4. 139 pp. Available on the internet: [http://www.who.int/water\\_sanitation\\_health/publications/plumbinghealthasp/en/](http://www.who.int/water_sanitation_health/publications/plumbinghealthasp/en/).

WHO. 2011. *Guidelines for Drinking-water Quality* (4th edition). Geneva: World Health Organization. Available at: [http://www.who.int/water\\_sanitation\\_health/publications/2011/dwq\\_guidelines/en/index.html](http://www.who.int/water_sanitation_health/publications/2011/dwq_guidelines/en/index.html).

WHO. 2011a. *WHO Technical Notes on Drinking-water, Sanitation and Hygiene in Emergencies*. [http://www.who.int/water\\_sanitation\\_health/hygiene/envsan/technotes/en/](http://www.who.int/water_sanitation_health/hygiene/envsan/technotes/en/) and then select the chapter. Revised 2013: [http://www.who.int/water\\_sanitation\\_health/publications/technotes/en/](http://www.who.int/water_sanitation_health/publications/technotes/en/).

WHO. 2011b. *Water Safety in Buildings*. Geneva: World Health Organization. 164 pp. [www.who.int/water\\_sanitation\\_health/publications/en/index.html](http://www.who.int/water_sanitation_health/publications/en/index.html).

WHO. 2014. *Water Safety in Distribution Systems*. WHO/FWC/WSH/14.03. 147 pp. [http://www.who.int/water\\_sanitation\\_health/publications/Water\\_Safety\\_in\\_Distribution\\_System/en/](http://www.who.int/water_sanitation_health/publications/Water_Safety_in_Distribution_System/en/).

WHO. 2017. *Guidelines for Drinking-water Quality: Fourth edition incorporating the first Addendum*. Geneva: World Health Organization. 631 pp.  
[http://www.who.int/water\\_sanitation\\_health/publications/drinking-water-quality-guidelines-4-including-1st-addendum/en/](http://www.who.int/water_sanitation_health/publications/drinking-water-quality-guidelines-4-including-1st-addendum/en/).

WRF. 2010. *Impacts of Lining Materials on Water Quality*. Water Research Foundation and Drinking Water Inspectorate. 218 pp. <http://dwi.defra.gov.uk/research/completed-research/2000todate.htm> or <http://www.waterrf.org/PublicReportLibrary/4036.pdf>.

WRF. 2015. *The Assess-and-Fix Approach: Using Non-Destructive Evaluations to Help Select Pipe Renewal Methods*. 176 pp.  
<http://www.waterrf.org/PublicReportLibrary/4473.pdf>.

WRF. 2015a. *Assessing Performance of Biofilm Sampling Approaches*. Water Research Foundation in conjunction with USEPA. 148 pp.  
<http://www.waterrf.org/PublicReportLibrary/4368.pdf>.

WRF. 2015. *Legacy of Manganese Accumulation in Water Systems*. PDF Report #4314. Water Research Foundation. 193 pp.  
<http://www.waterrf.org/PublicReportLibrary/4314.pdf>.

WRF. 2016. *Case Studies to Identify Occurrence, Accuracy and Causes of Reverse Flow Using Meter Systems*. November. Project Number: 4384.  
<http://www.waterrf.org/resources/magazine/Pages/Current-Issue.aspx>.

WRF. 2016a. *Metals Accumulation and Release within the Distribution System: Evaluation and Mitigation* [Project #4509]. Water Research Foundation.  
<http://www.waterrf.org/Pages/Projects.aspx?PID=4509>.

WSTB. 2005. *Public Water Supply Distribution Systems: Assessing and reducing risks – first report*. Water Science and Technology Board. 58 pp.  
[http://books.nap.edu/catalog.php?record\\_id=11262](http://books.nap.edu/catalog.php?record_id=11262).

WSTB. 2006. *Drinking Water Distribution Systems: Assessing and reducing risks*. Water Science and Technology Board. 404 pp.  
[http://www.nap.edu/catalog.php?record\\_id=11728](http://www.nap.edu/catalog.php?record_id=11728).



# Chapter 17: Monitoring, water treatment and drinking-water

## Contents

|             |  |           |
|-------------|--|-----------|
| <b>17.1</b> | <b>Introduction</b>  | <b>3</b>  |
| 17.1.1      | Test methods   | 3         |
| <b>17.2</b> | <b>Sampling</b>  | <b>4</b>  |
| <b>17.3</b> | <b>Monitoring for process control</b>                      | <b>8</b>  |
| 17.3.1      | Planning a monitoring programme                            | 8         |
| 17.3.2      | Installation   | 11        |
| 17.3.3      | Standardisation  | 12        |
| 17.3.4      | Process control  | 14        |
| <b>17.4</b> | <b>Continuous monitoring for compliance</b>                | <b>20</b> |
| 17.4.1      | Priority 1 determinands                                    | 20        |
| 17.4.2      | Priority 2 determinands and indirect indicators            | 23        |
| 17.4.3      | Control limits   | 24        |
| 17.4.4      | Recording and storing results                              | 25        |
| <b>17.5</b> | <b>Testing</b>   | <b>26</b> |
| 17.5.1      | Introduction   | 26        |
| 17.5.2      | Appropriate testing  | 27        |
| 17.5.3      | Online monitoring  | 28        |
| 17.5.4      | Quality assurance, quality control and testing proficiency | 31        |
| 17.5.5      | Accuracy, precision, uncertainty of measurement            | 33        |
| 17.5.6      | Referee methods, standards and traceability                | 35        |
| 17.5.7      | Calibrating a method against the referee method            | 38        |
| 17.5.8      | Reporting the results                                      | 39        |
| 17.5.9      | Records  | 40        |

|             |  |           |
|-------------|--|-----------|
| <b>17.6</b> | <b>Comparing test results against a MAV</b>                      | <b>42</b> |
| 17.6.1      | Uncertainties of measurement                                     | 42        |
| 17.6.2      | Comparison of a measurement with a fixed value                   | 44        |
| 17.6.3      | Approaches considered in developing the method used in the DWSNZ | 45        |
| 17.6.4      | Approach adopted in the DWSNZ                                    | 47        |
| 17.6.5      | Detection  | 47        |
|             | <b>References</b>  | <b>50</b> |

### List of tables

|             |   |    |
|-------------|---|----|
| Table 17.1: | Process control monitoring by treatment stage in a conventional process                 | 9  |
| Table 17.2: | Instruments and examples of their application   | 10 |
| Table 17.3: | Drinking-water Standards for New Zealand: requirements for continuous online monitoring | 26 |
| Table 17.4: | Types of precision associated with test results   | 34 |
| Table 17.5: | Suggested report form   | 40 |

### List of figures

|              |   |    |
|--------------|---|----|
| Figure 17.1: | Typical standard curve applicable to most test parameters       | 12 |
| Figure 17.2: | Closed loop control – a flow paced lime pump with pH correction | 14 |
| Figure 17.3: | An example of a distributed control arrangement                 | 17 |
| Figure 17.4: | An example of a SCADA arrangement                               | 18 |
| Figure 17.5: | A telemetry system arrangement                                  | 19 |
| Figure 17.6: | Hypochlorite ion vs hypochlorous acid at various pH values      | 23 |
| Figure 17.7: | Example of use of control limits                                | 24 |

## 17.1 Introduction

Monitoring involves sample collection, delivery, storage, testing, and recording and reporting the results.

GIGO (garbage in, garbage out) is as true for water monitoring as it is for any other endeavour, perhaps more than many.

One cannot expect to obtain good data if a sample is taken incorrectly (or even inappropriately), no matter how good the laboratory procedures are. This issue is made all the more important when we recognise that many of the determinands we are looking for in water are often at very low concentrations, particularly for finished drinking-water.

Generally there is a lot of information on analytical techniques, and when a doubtful result is obtained it is a natural reaction to check the test procedure.

However, in the analysis of errors, it is not unusual to find that the reporting process is often the cause. Common causes include poor handwriting, entering results in the wrong column (ie, transcription errors), and calculation errors. Reporting procedures also require a quality assurance step. A sound approach is to get someone else to check all calculations and data entries. Whatever process is used, it should be documented.

Risk management issues related to monitoring are discussed in the MoH Public Health Risk Management Plan Guide PHRMP Ref: G2: General – Monitoring.

### 17.1.1 Test methods

Standard Methods (APHA, AWWA, WEF) includes most methods commonly used in water laboratories.

The USEPA regularly updates their *Analytical Methods Approved for Compliance Monitoring under the Enhanced Surface Water Treatment Rule*. See: [http://www.epa.gov/safewater/methods/pdfs/methods/methods\\_swtrules.pdf](http://www.epa.gov/safewater/methods/pdfs/methods/methods_swtrules.pdf).

The USEPA has a document titled *Chemical/Name Index to EPA Test Methods* which can be found at <http://www.epa.gov/region1/info/testmethods/pdfs/testmeth.pdf>. This gives access to details of many USEPA methods.

Going to <https://www.nemi.gov/home> and clicking on 'browse all methods' (run by USGS and USEPA) allows access to the details of many analytical procedures, although not Standard Methods (APHA, AWWA, WEF).

## 17.2 Sampling

Sampling is an integral part of drinking-water quality management and is discussed frequently throughout the DWSNZ and these *Guidelines*. This section discusses sampling in a fairly general manner. More detailed references to sampling appear in the specific chapters, as follows:

- Chapter 1: Appendix: Statistical issues in drinking-water standards
- Chapter 2: Management of community supplies
  - Section 2.4: Compliance
- Chapter 3: Water sources
  - Section 3.2.2: The quality of groundwater
  - Section 3.2.4: Establishing the security of an aquifer
- Chapter 4: Selection of water source and treatment
  - Section 4.4: Evaluating the sources
- Chapter 6: Bacteriological compliance (*E. coli*)
  - Section 6.2: Monitoring for *E. coli*
  - Section 6.3: Microbiological compliance
  - Section 6.4: Sampling and testing
- Chapter 8: Protozoa compliance
  - Section 8.2: Source water
  - Section 8.6: Sampling and testing for protozoa and substitute tests
- Chapter 9: Cyanobacteria compliance
  - Section 9.5: Sampling and testing
- Chapter 10: Chemical compliance
  - Section 10.4: Sampling procedures and techniques
- Chapter 12: Treatment processes, pretreatment
  - Section 12.2.3: pH Adjustment
- Chapter 18: Aesthetic considerations
  - Section 18.4: Monitoring programme design
- Chapter 19: Small, individual and tankered supplies
  - Section 19.2.4: Water quality monitoring

Section 17.5.6 of this chapter discusses chain of custody procedures.

Care must always be exercised to see to it that:

- the appropriate container is used (generally glass, or approved plastic bottles with leak-free sealing). High-density polyethylene and Teflon™ bottles are commonly used for collecting natural water samples for routine analysis. Appendix 2 of DWSNZ includes a recommendation on sample containers, and whether the sample should be collected at the treatment plant or from the distribution system
- the container is clean (ie, free of the determinand before the sampled water is deposited). Laboratories should have documented procedures for bottle washing and storage

- there is no contamination of the sample by its inappropriate handling. Those collecting water samples should not make contact with samples. Smoking (of cigarettes, etc) is known to contaminate samples by elevating concentrations of ammonia, for example. People sampling for microbiological tests need to be trained in aseptic technique
- a sufficient volume is taken; different determinands (and analytical methods) can require very different volumes, eg, 100 mL for an *E. coli* test, and 100–400 L for a protozoan (oo)cyst assay of drinking-water
- the sample has been collected from the correct place, and if collected for compliance testing, includes the site identification code as listed in the *Register of Drinking-water Suppliers and Supplies in New Zealand*
- the sample container is unambiguously labelled, and in a fashion such that the label is still readable at the end of the laboratory procedures
- the sample is transported to the laboratory in reasonable time (especially for microbiological assays). Analytical laboratories should be consulted in advance about what is a reasonable period between sample collection and arrival at the laboratory, and about preservation measures (eg, storing samples in the dark and on ice) is usually acceptable for a wide range of determinands; other may have to be stabilised on site
- samples are stored in the laboratory in a suitable manner while the tests are being conducted
- samples are stored, for the time agreed with the client, after the results have been reported, so that any apparent discrepancies can be checked.

The safety and wellbeing of the sampling staff needs to be protected (eg, sampling environmental waters in high flow conditions, sampling water mains under pressure, sampling from pits, tunnels, valve chambers, boats, etc).

Given the broad sweep of issues that such considerations invoke, a list cannot be provided here of the all the issues and procedures. Details should appear in the water suppliers' WSPs or sampling manual, and/or laboratory documentation, or other appropriate manual(s). This should cover routine sampling and for responses to transgressions. Fortunately, there are three ready sources of information that should be used.

First, always contact in advance the laboratory that is to perform the analysis, so that correct and clean sample containers are used, in the correct manner. This contact should also elicit any special care that needs to be taken in performing the sampling (eg, protozoal assays may require that the sample be filtered in the field). At the same time, there should be a discussion with the laboratory about the detection limit that is desired for the analysis. This issue deserves careful attention if the usual detection limit is close to the MAV. In such cases it is much better to analyse the compounds with a method that has a lower limit of detection, reducing the number of measurements if budgets are limited.

Second, detailed advice can be obtained from texts and standards. Pre-eminent amongst these is *Standard Methods for the Examination of Water and Wastewater* (APHA, AWWA, WEF). The UK Water Research Centre has also published detailed guidance on many issues for water quality analysis (Hunt and Wilson 1986). BS 8550 (2010) is a standard for those involved in testing water and making it safe for use; it

provides an audit protocol to monitor conformity with declared, or assumed, practices in all areas of water quality sampling.

Third, the Drinking Water Inspectorate (DWI 2016) produced a manual for chemical and microbiological sampling.

Water suppliers will generally not always have ready access to the first two documents, but water laboratories will; yet another reason to consult with the laboratory before sampling.

Closer to home is the AS/NZS 5667 (1998), Water Quality – Sampling. Relevant publications comprise:

- Part 1: Guidance on the design of sampling programs, sampling techniques and the preservation and handling of samples
- Part 4: Guidance on sampling from lakes, natural and man-made
- Part 5: Guidance on sampling drinking water and water used for food and beverage processing
- Part 6: Guidance on sampling rivers and streams
- Part 7: Guidance on sampling of water and steam in boiler plants
- Part 8: Guidance on sampling wet deposition
- Part 11: Guidance on sampling of groundwaters.

Another matter to be considered in sampling is the location and time of sampling. These matters are addressed in Chapter 4: Selection of Water Source and Treatment, section 4.4, and Chapter 16: The Distribution System, section 16.2. And many are specified in the relevant compliance conditions in the DWSNZ.

Sections 4.3.8.1 and 4.4.4 of the DWSNZ refer to the need to collect samples for *E. coli* analysis on different days of the week. Water supplies are delivered seven days a week so suppliers need to know that the water quality is equally satisfactory on all seven; two conditions could make it not so:

- a) the treatment process or its monitoring is different during weekends/public holidays due to a lower staffing level
- b) the quality of the raw water varies due to some cyclic activity in the catchment.

Some examples of cyclic activities include:

- stock sale/auction day
- milking operations that lead to pulsed discharges of dairy shed wastes
- truck cleaning on (say) Friday afternoons or Saturday mornings
- factories that operate five days per week
- factories that perform different functions on one or more days
- vegetable growers that pick/wash produce in time for weekend or Monday markets
- holiday homes, motels and camping grounds that attract weekend visitors
- school holidays and weeks with statutory holidays
- Wednesday or Saturday horse race or sports meetings

- seasonal spraying, topdressing, ploughing activities, burn-offs
- irrigation or 'muck spreading'
- ski fields with high weekend patronage, etc.

The extent and duration of these effects will vary depending on whether the source is surface water or groundwater, and on the size, flow time and mixing conditions of the source, and the type of waste treatment (if any) employed by the above.

Standard Methods (APHA 2005) no longer has a procedure for protozoal assays. The DWSNZ (section 5.2.2.2) requires the use of a modified USEPA method (method 1623, a method that enumerates both *Cryptosporidium* oocysts and *Giardia* cysts). Sampling requirements for this method must be checked with the laboratory. Use accredited laboratories for compliance monitoring.

Sampling techniques are specialised, depending on the determinand and the site. It is recommended that sampling instructions be written up in a procedure manual or equivalent. See Sinton (1986) and Sundaram et al (2009) for discussion on groundwater sampling. Bottle washing, preservation, and storage requirements of collected samples should be included. Sample sites need an unambiguous descriptor so there is no confusion when different personnel are involved.

Training courses are available, such as: NZQA unit standards: 17891 Demonstrate knowledge of quality sampling techniques and programme design for a water treatment site (Level 4) (5 credits) and 29999 Undertake sampling and site testing procedures for drinking water treatment (Level 4) (6 credits). Contact Ministry of Health, Water NZ for further information, or <https://opusetc.co.nz/water-treatment-training>.

Automatic sampling can present a labour saving option, especially if samples are needed overnight or for a long period. Battery operated models are on the market, and samplers may be available for hire. Flow-proportional samplers are more common when sampling wastewaters. Matters that require consideration include:

- ensuring that the sample suction point is appropriate
- that the sampler can lift the water from the suction point to the bottles
- sample lines are not too long or too wide, ie, not allowing substances like algae, aluminium, iron, manganese and turbidity to settle out or adhere to the pipe surface
- the velocity through the sample tubing should exceed 0.6 m/s, for the same reason
- whether a composite sample or discrete samples are required or are more appropriate
- what sample volumes are required
- the frequency and duration of sampling
- whether the determinand(s) are stable during the collection and delivery period
- whether the samples should be stored refrigerated
- whether the sample bottles should contain a preservative.

## 17.3 Monitoring for process control

Control of all the processes used in water treatment is an important part of ensuring good water quality. Good control allows a process to be optimised. As a result, excessive dosing can be avoided, any carry-over of chemicals may be reduced, chemical costs are minimised, and problems become easier to solve.

Therefore good process control monitoring is needed to keep the process operating correctly or optimally. These process control tests contrast with the regulatory tests that produce data to demonstrate compliance, eg, with the Drinking-water Standards for New Zealand (DWSNZ). Regulatory testing is discussed in section 17.4.

For a particular plant, the type and amount of process control that should be used is determined by a balance of the requirements of the DWSNZ, raw water quality, the manufacturer's recommendations, the water supplier's policy, operator capability, complexity of the system, sensitivity of the process to optimisation, potential labour savings, and cost.

Good documentation of monitoring records can provide helpful information for when unusual raw water conditions recur.

### 17.3.1 Planning a monitoring programme

The monitoring undertaken at a water treatment plant will be a mix of manual and automatic monitoring. Automatic (online) monitoring is becoming increasingly common and results can be used to modify/control the process. Automatic monitoring minimises labour requirements and allows large amounts of data to be collected so trends can be examined and occasional changes in performance can be picked up and the process improved. Automatic monitoring can be expensive so is not always practical. In these cases either regular samples are collected and analysed in a laboratory, or the determinand is measured manually on-site using an instrument.

An excellent way to arrive at an appropriate level of process monitoring and control is by the compilation of a Water Safety Plan (WSP – formerly known as a Public Health Risk Management Plan, PHRMP). This process is described briefly in Chapters 1 and 2. Whether or not a WSP is undertaken, these risk management principles should be used when deciding how each determinand is to be measured and how often.

Table 17.1 shows examples of where process monitoring is commonly installed online or undertaken manually at a water treatment plant. In some cases monitoring is specifically required by the DWSNZ.

The ability to measure different contaminants is steadily improving with the development and refinement of new instruments.

Particularly in larger plants, important variables may be measured online by two identical instruments so that the values may be compared (dual validation). An alarm is raised if the measured value varies between the two instruments by more than a set



amount. In some systems, values are measured by three identical instruments (triple validation). In these systems, if one value varies from the other two by more than a set amount, it is assumed that this value is in error and the process continues to operate using the two agreeing values.

Often it is sufficient to install a second, cheaper type of instrument to give an alarm at very high or low levels. A common example is the installation of a level switch at high-high level (above normal high level) to activate an alarm if an ultrasonic level meter fails.

A great deal of data can be generated by monitoring systems. Where applicable, it is important that the data is stored in a manner that allows demonstration of compliance as required in section 3.2 of the DWSNZ. This should be taken into account when purchasing monitoring equipment. Some advice appeared in Colton (2015).

The monitoring of aspects of equipment condition is also recommended as part of the careful management of water treatment plant assets. This information can usually be obtained from the manufacturer. The AWWA Manual (M2, 3rd edition, 2001) covers instrumentation and control.

**Table 17.1: Process control monitoring by treatment stage in a conventional process**

| Determinand                    | Stage of treatment |             |               |            |                                   |
|--------------------------------|--------------------|-------------|---------------|------------|-----------------------------------|
|                                | Raw water          | Coagulation | Clarification | Filtration | Disinfection and water to supply* |
| Turbidity                      | R                  | O           | R             | S          | S                                 |
| Temperature                    | O                  |             | O             |            | O or S                            |
| pH                             | O                  | R           | O             |            | S                                 |
| Dissolved oxygen               | O                  |             |               |            |                                   |
| Colour (or UV <sub>254</sub> ) | O                  |             |               |            | R or S                            |
| Organic carbon                 | O                  |             | O             |            | O                                 |
| Conductivity                   | O                  |             |               |            | O                                 |
| Aluminium                      |                    |             | O             | R          |                                   |
| Alkalinity                     | O                  | O           | O             |            | R                                 |
| Chemical dose                  |                    | R           |               |            | R                                 |
| Sludge level/density           |                    |             | O             |            |                                   |
| Flow rate                      | R                  | R           | R             | R          | R                                 |
| Head loss/run time             |                    |             |               | R          |                                   |
| Disinfectant C.t               |                    |             |               |            | S                                 |
| Disinfectant residual          |                    |             |               |            | S                                 |
| Fluoride                       |                    |             |               |            | S                                 |
| Water level/volume             | R                  |             |               |            | R                                 |
| Pressure                       |                    |             |               |            | R                                 |

\* Monitoring requirements depend on disinfection process used.

Notes: See turbidity row if using particle counting. S refers to DWSNZ for specific minimum requirements. R means recommended. O means optional.

Some of the more common instruments used in water treatment plants are listed in Table 17.2.

**Table 17.2: Instruments and examples of their application**

| Variable                                | Examples of application  |
|---|--|
| Equipment status (on/off)               | Confirmation of correct starting/stopping of equipment   |
| Position switch                         | Confirmation of correct valve opening/closing  |
| Temperature (process or equipment)      | Temperature compensated filter back wash flow rate<br>Monitoring for disinfection efficiency, c.t value  |
| Voltage or current draw                 | Confirmation of condition of pumps and other motorised equipment   |
| Pressure/head loss                      | Indication of a blockage in a component of the plant<br>Differential pressure across a filter indicating head loss development<br>Pressure in distribution system  |
| Flow rate                               | Recycle return rate<br>Control of processes such as flow proportional dosing of chemicals<br>Drinking-water production rate<br>Accurate flow splitting (eg, to settling tanks or filters)<br>Control of rate of change of flow to flow sensitive processes |
| Level                                   | Warning of overflow<br>Indication of filter head loss development<br>Indication of storage volume (and time for c.t value)<br>Control of pump wells  |
| pH                                      | Control of pH adjusting chemicals<br>Monitoring for effect on coagulation<br>Monitoring for effect on disinfection<br>Monitoring for effect on water aggressiveness  |
| Alkalinity                              | Monitoring for effect on coagulation<br>Monitoring for effect on water aggressiveness  |
| Conductivity                            | Can indicate raw water changes not detected by other instruments   |
| Streaming current                       | Control of coagulant dose  |
| Sludge level/density                    | Operation of sedimentation tanks   |
| Disinfectant residual concentration     | Control/confirmation of disinfectant dose and residual   |
| UV intensity                            | Control/confirmation of UV disinfectant dose   |
| Fluoride                                | Control/confirmation of fluoride dose, final concentration   |
| Aluminium                               | Control of coagulation; individual filter performance  |
| Dissolved oxygen                        | Monitoring condition of raw water (eg, aeration of groundwater)<br>Can affect oxidation state of metals in raw water   |
| Turbidity/particle count                | May be used as indicator of coagulant requirement<br>Quality of recycle water<br>Measuring performance of coagulation/sedimentation/filtration<br>Disinfection efficacy<br>Indicates contaminant (eg, protozoa) breakthrough from filters                  |
| Colour/organic carbon/UV <sub>254</sub> | May be used as indicator of coagulant requirement/performance<br>May be used to indicate DBP potential in treated water<br>Transmittance/absorbance needed for UV disinfection   |
| Hour run meter                          | Various, eg, pumps, UV lamps, filter run   |
| Direct integrity test                   | Membrane filtration status/compliance  |
| Weight                                  | For example monitoring the rate of consumption of chlorine   |

## 17.3.2 Installation

Where a water treatment plant is fitted with continuous monitoring, instruments should always be installed in a way that they:

- measure samples that are representative of the full flow of water past a given point
- measure samples taken from the optimum point in the process, eg, raw water should be measured before any chemicals or recycle flows are added
- are accessible for maintenance and standardisation.

Many instruments have samples piped to them. In this case the installation should:

- not introduce excessive lag time or where this will affect process control or alarms (this can occur through the use of long sampling lines or excessively large air traps)
- not allow adsorption or precipitation in the sample line (a continuous flow greater than 0.6 m/s through the sample line should prevent this)
- allow for the safe disposal of analyser waste, particularly where buffers and other chemicals are added and where wastewater is returned for treatment
- not be sited where there may be electrical interference, in direct sunlight, or where there is excessive vibration
- allow the flow to analysers to be regulated and checked. Other uses on the sample line should be restricted so there are no variations of flow. Normally the drain from the analyser should be visible so that the continuity of flow can be observed easily.

The location of an instrument or sampling tap on a pipe can also be important. For example, a sample collected from the crown of the pipe can contain entrained air that will lead to false high results for determinands such as turbidity. Samples taken from near the bottom of a tank might include uncharacteristic amounts of grit or silt.

Most instruments have their own specific installation requirements. An inexperienced instrument installer might be caught out by common issues such as:

- flow to a turbidimeter should not be pumped as this will break up particles and may change the turbidity. Air bubbles need to be excluded as they can cause false high turbidity readings. A bubble trap is often used to control air bubbles
- light shining on sample lines or cell/sensor housings can result in algal growth which can affect readings such as turbidity
- conventional magnetic flowmeters are well known for being very sensitive to turbulent flow. For this reason they are always installed in a straight section of pipe. Variable conductivity in the water (such as from hydrated lime that has not been dispersed fully) can also severely disrupt accuracy
- the extremely low conductivity found in some waters can cause erroneous pH readings. Many manufacturers supply electrodes designed specifically for low conductivity waters.

As is the case with any equipment, the installation should always be in accordance with the manufacturer's recommendations.

### 17.3.3 Standardisation

Values measured by instruments often drift away from the true value as a sensor accumulates dirt or is affected by use in some other way. As a result it is important to check the value regularly. This is essential in the case of variables that are monitored for compliance.

Standardisation is usually achieved by comparing the instrument reading against standards. Standards are solutions (usually), of a known (traceable) concentration.

Most instruments must be checked regularly against a zero reference. Generally this is achieved by running a sample through the unit that is known to be at the zero level (eg, distilled water) then re-setting the zero reading. Some instruments also require an electrical zero check.

Then the feed is changed to a sample with a known concentration, ideally at the high end of the measuring range to set the span. The high end should be just above the maximum readings expected. For most instruments used at a water treatment plant this two-point calibration would be adequate, provided the standard curve is known to be a straight line. The standardisation procedure for each instrument should be documented in the WSP or other appropriate manual. When deciding how, and how often, to standardise, guidance should be sought from the manufacturer's instructions and, when relevant, from the DWSNZ. If the instrument standardisation shows that frequent readjustment is needed, checks (and/or servicing) will be needed more frequently.

**Figure 17.1: Typical standard curve applicable to most test parameters**

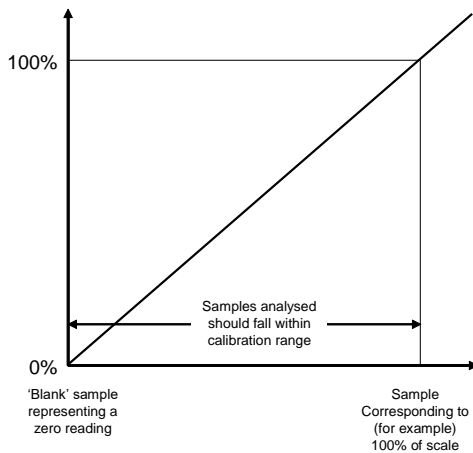

Between standardisations, the meter reading should be checked (verified) by an alternative method such as testing a control sample, or comparing the reading against a standardised hand-held meter. If this check is outside acceptable limits, the instrument should be restandardised. Acceptable limits need to be defined, eg, by the instrument manufacturer, and the procedure should be documented in the WSP. The control sample check is generally performed at least weekly depending upon the environment, operating conditions and manufacturer's instructions, but generally no less frequently than monthly.

A permanent record, eg, a standardisation book, of checks (standards and control samples) is needed. Information should show the concentrations checked, the concentration the instrument read for these, the time and date, the person doing the work, and a comments column for entering actions such as adjustments made to the instrument, or whether it was repaired or parts replaced. If the instrument needs to be adjusted, it should be restandardised to show that it was adjusted correctly.

Details relating to the preparation of standards need to be recorded as well, eg, when standardising ferrous ammonium sulphate for chlorine titrations using DPD. Section 10.5 of the *Guidelines* discusses measurement of pH.

Standards should be stored carefully, and be dated, either the date prepared or date received, and they should also show the expiry date. When standardising with a new standard for the first time, compare it against the readings of the old standards. This will show whether the old standard has been deteriorating at a faster rate than expected, or may show that the new standard is incorrect – it happens! When there is doubt, the process control instrument can be checked against a laboratory instrument.

Appendix A2.4 of the DWSNZ specifies the requirements for standardising turbidimeters used for compliance testing. It also discusses verification of the turbidimeter, which is equivalent to using a control sample as discussed above. Further information appears in section 8.6.2.1 of the *Guidelines*.

Generally, standards are prepared (or purchased) with a known uncertainty (see section 17.5.5), and the instrument reading is taken at face value. For example, if a 0.40 mg/L FAC standard with an uncertainty of measurement of 0.03 mg/L used to calibrate an online chlorine analyser reads 0.38 or 0.42 mg/L, the instrument is operating acceptably. If it reads 0.36 or 0.44 mg/L it would need to be restandardised. See Chapter 8: Protozoa Compliance, section 8.6.2.1 for further discussion relating to calibration of turbidimeters.

Although the previous paragraph stated that 'the instrument reading is taken at face value', the DWSNZ state (in Appendix A1.2.3) that 'equipment used to demonstrate compliance must be suitable for the purpose'. The DWSNZ could not be more precise than that because of the large number of possible determinands and the large number of techniques available for measuring them. For example, an online chlorine analyser with an uncertainty of measurement of 10 percent at the 0.2 mg/L level would be suitable for compliance monitoring. A turbidimeter with an uncertainty of measurement of 10 percent at the 0.50 NTU level would also be suitable for most purposes. But that same turbidimeter may have an uncertainty of measurement of 50 percent at the 0.10 NTU level, and this would not be suitable for use at such low turbidities.

## Instrument condition assessment

The condition of the instrument and any supply tubing should be checked as part of standardisation procedure. Transparent supply tubing will need replacing if there are growths or deposits developing that could affect results. The flow rate of the sample and any other requirements (eg, buffer supply) should be confirmed as part of the check. The sample flow rate may vary depending on the head available at the sampling point so check the flow at high and low water levels.

Chemical cleaning will be needed if a sensor has been coated by chemical deposits. For example, alum floc, lime, iron and manganese in water can cause chemical build-up that is often removed with a mild acid (check instrument operating manual first). In the case of raw water monitoring, there may be an accumulation of sediment in the unit that needs cleaning, particularly when raw water turbidity is high.

## 17.3.4 Process control

The value of a measured variable may be used as an input to a controller (usually a Programmable Logic Controller or PLC).

Controllers for automatic operation are usually designed to:

- control critical tasks (eg, the use of flow and target alum dose to control alum dosing pump speed and/or stroke)
- minimise tedious repetitive tasks (eg, at a certain time or head loss, operate valves and pumps to carry out a filter backwash)
- provide a tool for process supervision (eg, measure/record pH, turbidity, free available chlorine, etc).

**Figure 17.2: Closed loop control – a flow paced lime pump with pH correction**

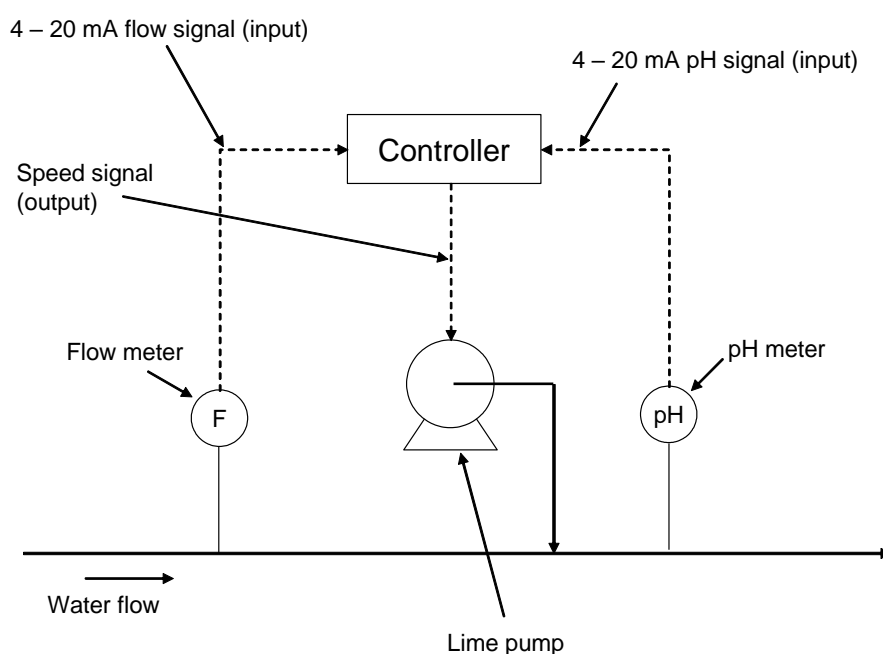

Many PLCs are programmed to control a number of processes. However, in some situations an instrument or sensor may have a built-in controller, or it may be connected to a single controller that is dedicated to the process. The number of inputs and outputs is fewer than for a centralised controller, and they can be located in the field close to the process.

When a sensor measures a variable, the measured value must be transmitted to the controller in some way. Similarly the controller output signal must be transmitted to the actuator (a controlled device such as a valve actuator or variable frequency drive). These signals may be transmitted over a very short distance or over thousands of metres.

Process control may be either feed-forward, where information from the process is measured before the process is acted on to correct the controlled variable (ie, predictive), or feedback control, in which information from the process is used to correct the controlled variable after the process has been acted on.

A feedback controller needs only measure the process variable, determine if it has deviated too far from the setpoint, apply the necessary corrective action, wait to see if the error goes away, and repeat as necessary. This closed-loop control procedure will eventually have the desired effect provided the controller parameters match the process reaction time.

On the other hand, a controller that tries to eliminate errors too quickly can end up over-correcting to the point that the process variable overshoots the setpoint, causing an error in the opposite direction. Process oscillations can go on forever as the process variable will always be too high or too low; this is referred to as hunting. Worse still, the oscillations can sometimes grow in magnitude until tanks start overflowing or equipment fails.

Control can be made more or less aggressive by adjusting the proportional (P), integral (I), and derivative (D) gains; this is referred to as 3-term control.

## Electrical signals

The most common transmission system is an electrical 4–20 mA signal. A screened twisted pair (STP) of copper wires is used to form a DC current loop. A 4–20 mA transmission system can be used for analogue signals. Alternatively, fibre optic cable that transmits a light signal is being used increasingly, although usually more expensive. For a water treatment process there may be a need for thousands of twisted pair cables. The use of modern fieldbus devices can minimise cable requirements.

## Pneumatic signals

Pneumatic control is still common and is often preferred on membrane systems due to the number of valves and low cost. Many water suppliers remain standardised on pneumatic control. Pneumatic transmission may be used over shorter distances than for electrical transmission. The controlled variable is measured and converted to air pressure at the sensor. A transmitter sends the air pressure through a single tube to a receiver in the controller where the pressure is converted into a movement of bellows

or a diaphragm. Pneumatic control creates lags with long distances as the air pressure is transmitted through a tube. Typical pressure control ranges are 20–100 kPa.

## Hydraulic control

Alternatively, some systems may still use hydraulic control, either water or oil, to transmit the signals. This form of control still exists on many older plants. An application of hydraulic control in water systems is the diaphragm valve that has smaller control valves connected to it to allow pressure and flow control functions to operate on the main valve.

Hydraulic control systems require that water used in the hydraulic system be clean, to prevent clogging of the pilot valves and the control lines. Hydraulic control lines must be protected where there is a danger of freezing.

## Digital data links

There has been increasing emphasis to remove the need for thousands of twisted pair cables to transmit signals that were previously transmitted as a 4–20 mA current. To do this an analogue signal must be converted to a digital signal via a microprocessor in a transmitter. A term that describes the digital replacement for the 4–20 mA DC communication system is the digital fieldbus.

## Distributed control

Distributed control systems (DCS) were first introduced in the 1970s as an efficient system for large installations where there were many field based sensors, actuators and controllers. A DCS allows for the feedback controllers to be located closer to the sensors and actuators, instead of in a centralised control room. The communication between the controllers and the operator interface screen(s) is provided via a digital fieldbus, or data highway, or Local Area Network (LAN) typically using Ethernet that connects the controllers, displays and computers. An advantage of this system is that if the communication link is lost, the individual controllers can remain functional.

Typical processes controlled are chemical addition and filtration. The processes are controlled by monitoring the status of pumps, tanks levels and turbidity.

Like SCADA systems, the data collected from plant and equipment on site can be massaged and displayed as useful information on screens in control rooms and specific plant areas. The information can be logged within plant historian databases to support operations, maintenance and planning activities.



**Figure 17.3: An example of a distributed control arrangement**

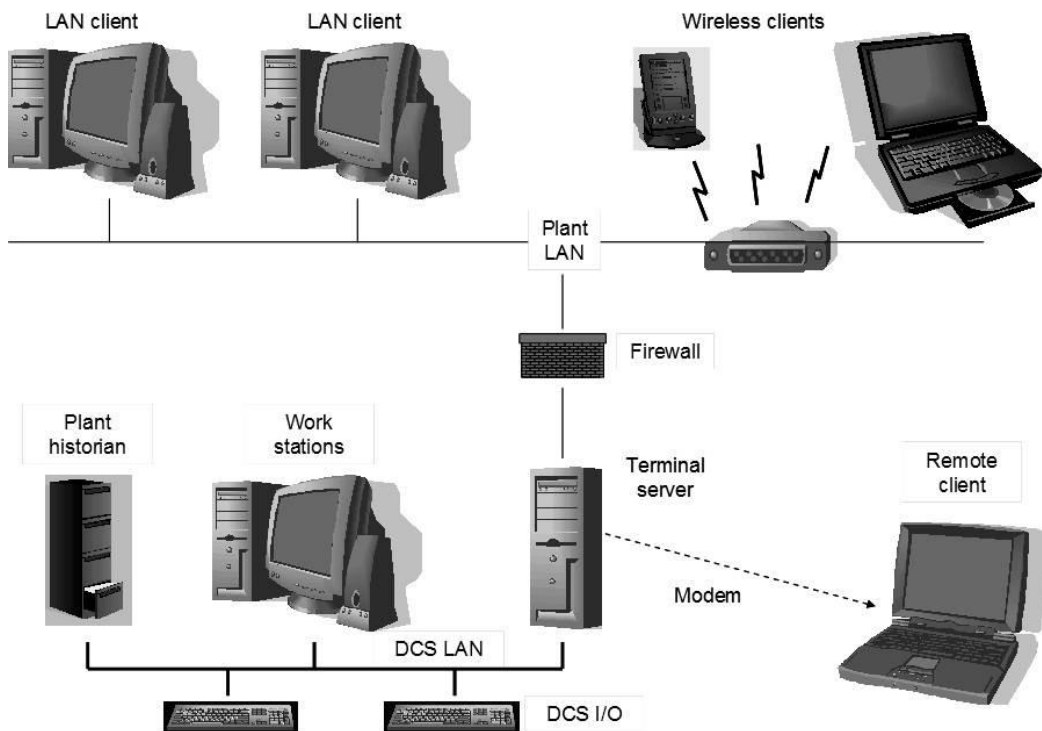

## SCADA

It is increasingly common for the values recorded by online instruments to be transmitted to SCADA (supervisory control and data acquisition). SCADA is a name for software-based operator interfaces that use symbols and icons for indicating the operational status of a plant as well as facilities to initiate controls.

Usually the SCADA will reside in a PC. However, the logic for the controls usually resides in the PLC or in dedicated controllers, with the SCADA software communicating with the PLC. The SCADA software packages can allow considerable transfer and storage of data for process monitoring. The operator interface is the screen display that may incorporate sophisticated graphics to illustrate the plant components and status of the components/processes. Similarly there may be a facility to demonstrate historic trends. Generally the screen will display alarms that are generated by unacceptable deviation of process variables from set points that have been determined by the operator.

The process monitor that displays alarms may also connect directly to further devices that serve as alarm warning devices: hooters, sirens, lights, auto-diallers and pagers. Remote connection to the SCADA system can be provided through a number of techniques (see telemetry).

In some cases the system enables the manager/operator to dial in to the plant to turn equipment on and off and make changes to set points (usually from an internet enabled laptop). Sometimes this can mean that site attendance in response to alarms is not necessary. Very often the operator can stabilise the system or call in additional resources prior to attending the site.

Generally SCADA systems cover a large geographic area, automatically collecting data from remote sites such as pump stations, service reservoirs and dams. Typical data collected is pump flow, reservoir level and water main pressure.

The software provided with many of the data acquisition systems, which can be custom designed for SCADA/DCS systems, also allows operators to trend and analyse data. Easy-to-use software provides clear graphics for operators to evaluate. Typically, data can be exported to various spreadsheets or database programs for later analysis. Software is interactive, with the ability to change colours, and graph sizes.

**Figure 17.4: An example of a SCADA arrangement**

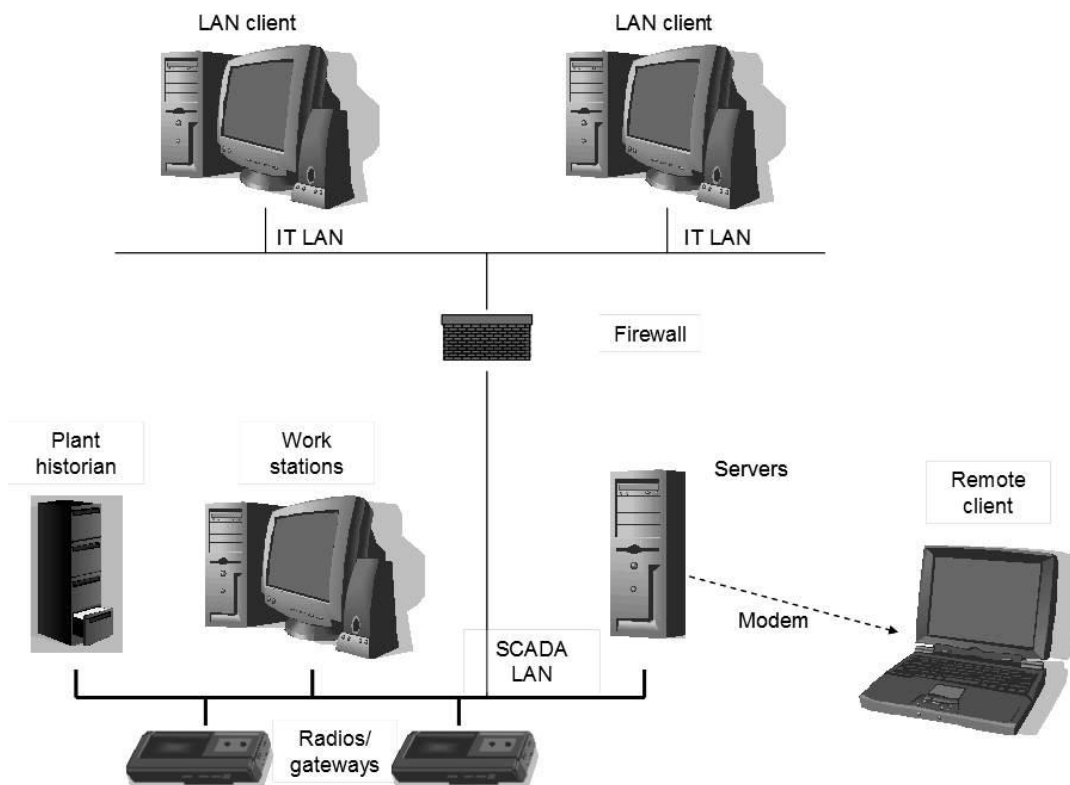

Having all this data at the fingertips of the operator is an extremely useful tool in quality management and trouble-shooting. For example, operators can analyse turbidity data to:

- evaluate peaks in filtered water turbidity for individual filters
- check how storm events affect the filtration capabilities
- examine the effect of various chemical dosages on filtered effluent
- check the setting on the streaming current meter
- compare different filters within a system
- assess the effect of different flow rates on filter performance.

## Telemetry

Telemetry is the capability of transmitting or retrieving data over long distance communication links. This is generally by telephone or radio link, but can be by satellite link in remote locations.

To transmit information from a number of locations to a central monitoring station, different communication systems may be employed, including microwave, radio, telephone, dedicated land lines, or even the internet.

**Figure 17.5: A telemetry system arrangement**

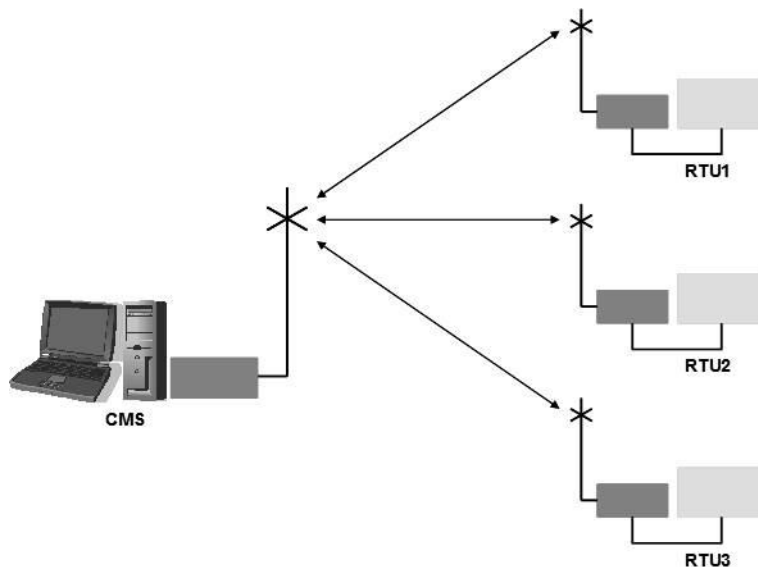

In Figure 17.5, RTU stands for remote transmitter unit. These units can collect information from PLCs, controllers, or even sensors, and transmit to the central monitoring unit (CMS).

Problems that often occur with telemetry/SCADA systems include:

- lightning strikes, especially on radiotelephone antennae. Note that during some storms, high level service reservoir alarms may activate due to the reservoir transducers reacting to low atmospheric pressure
- signal loss in hard-wired communications links due to earthing or cable breaks, or moisture ingress
- radio link loss due to atmospheric conditions or physical damage, especially to repeater stations.

## 17.4 Continuous monitoring for compliance

Section 3.2 of the DWSNZ specifies the minimum requirements for continuous (online) monitoring to demonstrate that public health is being protected. The minimum requirements vary depending on the determinand, the method of treatment, source, and population served. While standards are different for lesser populations for reasons of affordability, monitoring is equally important, regardless of size. The situations requiring continuous monitoring in DWSNZ appear in Table 17.3, and are discussed further in section 17.5.3.

See section 17.3 for general information about process control monitoring, much of which applies to this section as well.

Current guidance in the UK for drinking water compliance monitoring allows the use of online monitors for data collection; DWI (2014). The DWI publication specifies the extent to which online and laboratory data can differ for the online data to be acceptable; it sets limits on the mean difference between data pairs of online and laboratory data, and on the 95 percent confidence range of the difference between online and laboratory data pairs. The report finds that there are some important differences between online and laboratory measurements of chlorine and turbidity; these are discussed. UK water companies use duplication and triplication of instruments as a means of detecting instrument problems and of achieving high availability of key measurements.

### 17.4.1 Priority 1 determinands

The regulatory requirements for continuous monitoring relate primarily to Priority 1 determinands. For protozoa, an alternative parameter must be used to demonstrate compliance because measuring infectious protozoa directly in drinking-water is impractical at present. This is because tests can take days to complete, cannot be measured continuously, require very large samples, highly trained staff are needed, and the tests are very expensive.

#### Protozoa

Continuous turbidity monitoring is used to indicate the likelihood of *Giardia* cysts and *Cryptosporidium* oocysts being present in water leaving filters. This is based on evidence correlating turbidity with (oo)cyst numbers, documented in USEPA (2003/2006). See also Chapter 8: Protozoa Compliance.

As an example, for a plant serving more than 10,000 people, which is treating a surface water or a non-secure bore water by chemical coagulation and filtration, continuous turbidity monitoring on each filter is required in order to meet the protozoal compliance criteria in the DWSNZ. Continuous measurement of the individual filter turbidity provides operators with the basis for understanding what the filter is doing. For example:

- poor performance of an individual unit can be detected because the effect is not diluted by the other filters
- short term deterioration is detected
- ripening times and the optimum time to wash the filter become clearer
- by measuring at the filter the effect of subsequent processes such as post filter lime dosing is excluded.

Particle counting is an increasingly common method for monitoring the performance of filtration systems. Particle counters are more sensitive than turbidimeters although they are relatively expensive, susceptible to spikes in turbidity and are difficult to calibrate on-site (see Chapter 8: Protozoa Compliance, section 8.6.2.2). These units indicate particle numbers and sizes, including particles that are in the size range of protozoa. A particle counter is frequently recommended to ensure compliance as it will often detect deterioration in filter performance before detection by a conventional turbidimeter. Laser turbidimeters are now available with greatly improved sensitivity over conventional units. When turbidity and particle counts are both measured it is good practice to supply the instruments from a common sample stream.

Another method for demonstrating protozoal compliance is direct integrity testing (DIT), used for membrane filtration plants. There are no continuous DIT methods suitable for compliance testing at present.

Methods for monitoring compliance for protozoal inactivation rely on disinfectant dose rates (chlorine dioxide, ozone and UV dose) along with the monitoring of parameters that affect the performance of the disinfectant, such as temperature, UVT, turbidity, contact time and the residual remaining after treatment (chlorine dioxide, ozone).

See Chapter 8: Protozoa Compliance, sections 8.4.4.3 and 8.6.2.6 for discussion relating to operation and standardisation of UV intensity meters, and section 8.4.4.3 re UV transmission.

## Bacteria

The DWSNZ require bacterial compliance monitoring of water leaving the treatment plant to be measured directly (*E. coli*) at regular intervals, or by continuously monitoring the free available chlorine equivalent (FACE) or chlorine dioxide residual, or by a combination of *E. coli* and continuous ozone monitoring if disinfecting with ozone. *E. coli* testing is covered in Chapter 6.

When the water has a residual of at least 0.2 mg/L chlorine or chlorine dioxide (allowing for the effect of pH when using chlorine) after a minimum of 30 minutes' contact time, it is assumed (based on years of experience) that the bacteria will have been inactivated. Because free available chlorine and pH (and hence FACE) can be measured continuously, the reliability of disinfection can be demonstrated. Refer to Chapter 6: Bacterial Compliance, section 6.3.7 and Chapter 15: Treatment Processes: Disinfection, section 15.2.9). Continuously recording FAC and pH analysers will generally be more economical than the daily *E. coli* monitoring required. For water treatment plants serving fewer than 10,000 people, less than daily *E. coli* monitoring is required, so continuous FAC and pH analysers may become less economic as an alternative monitoring option. In practice, however, this level of process control is desirable for any sized plant. It also assists to reduce the amount of monitoring for *E. coli* in the distribution system.

The reliability of chlorine and chlorine dioxide monitoring is such that some *E. coli* monitoring of water in the distribution system can be substituted with FAC or chlorine dioxide monitoring (section 4.4.4.2 of the DWSNZ). Bulk water suppliers can measure FAC or chlorine dioxide continuously in lieu of *E. coli* testing (section 4.4.7 of the DWSNZ). Refer also to Chapter 6 for details of compliance issues.

Most FAC instruments are designed to indicate the total of two forms of FAC, ie, hypochlorite ion and hypochlorous acid (HOCl). In general they are only sensitive to the form that is prevalent at low pH values (hypochlorous acid). For this reason a buffer is often added to the sample to lower the pH and convert both forms of FAC to the detectable form (HOCl) and the sensor simply reads the total FAC.

Some instruments indicate the FAC without adding a buffer. They can do this by measuring the amount of hypochlorous acid and calculating the proportion it makes of the total using a relationship based on sample pH. These instruments allow the waste from the meter to be recycled more easily but depend heavily on the accuracy of both the FAC and pH calibration. This is a problem at a pH approaching 8 as the proportion of hypochlorous acid becomes very small, magnifying any error. Refer also to Chapter 15: Disinfection, section 15.5.1.1.

A spreadsheet method for converting FAC concentrations to FACE when the pH is greater than 8 appears in Chapter 6: Bacterial Compliance, section 6.3.7.

**Figure 17.6: Hypochlorite ion vs hypochlorous acid at various pH values**

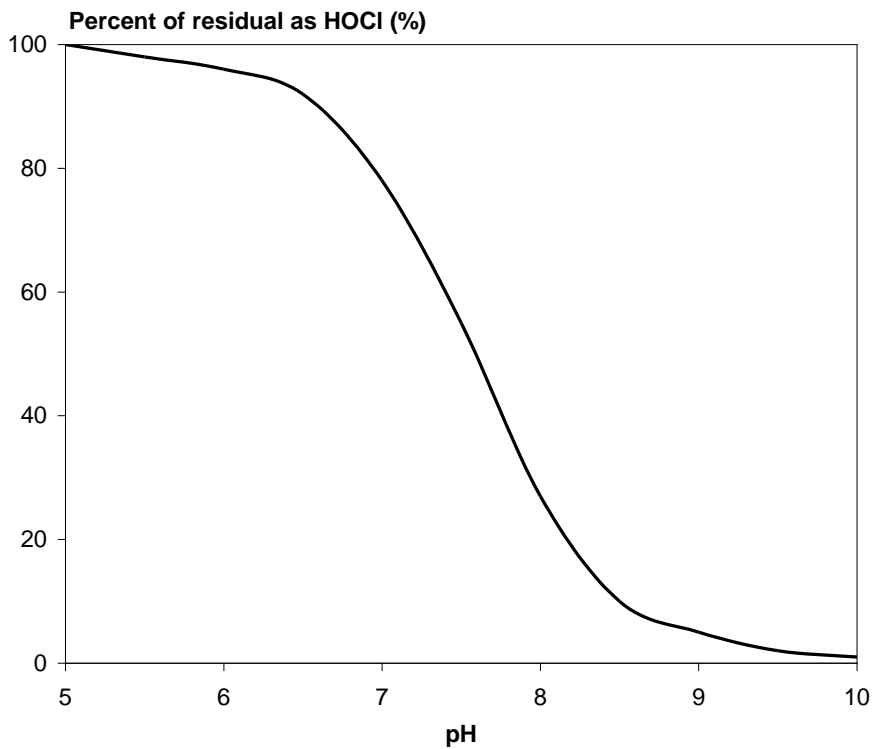

## 17.4.2 Priority 2 determinands and indirect indicators

The MAV for fluoride is 1.5 mg/L. The fluoride concentration in the water leaving most water treatment plants that fluoridate is around the 0.8 mg/L level, thereby making fluoride a priority 2A determinand, requiring weekly analysis. It is possible to monitor fluoride continuously for both process control and compliance purposes.

Most monitoring requirements for Priority 2 determinands are satisfied by manual sampling and laboratory analysis. Nevertheless it is good practice to monitor selected parameters online to confirm that the water treatment plant operates well within compliance limits.

Absorbance ( $A_{254}$ ), also sometimes measured as transmittance, is a useful indication of the level of natural organic matter (mainly humic and fulvic substances) that may give rise to disinfection by-products following disinfection. In organic-rich waters,  $A_{254}$  should be measured prior to chlorination. This test (reported as UVT) is also needed when using UV light for disinfection.

### 17.4.3 Control limits

To comply with the DWSNZ, a water supply should be operating within any MAVs or operational requirement limits set by the DWSNZ. The DWSNZ recommend that water suppliers establish control limits. Control limits warn that the water supply or treatment process is approaching transgression level. These should always be chosen conservatively to raise alerts and/or undertake corrective action before the MAVs or operational requirements are reached. It is recommend that water suppliers decide on a control limit for every MAV and operational requirement that relates to their system. Then they are to plan preventive measures that will come into play when the measured determinand reaches the control limit; these control limits and preventive measures are to be included in their WSP.

On occasions when water quality moves outside the acceptable range an operator alarm should be raised. Ideally the alarm limits should be set well below the 'not to exceed' limits in the DWSNZ; a limit set at about two-thirds the standard or requirement is quite common. Process control limits should be set to ensure that supply of non-compliant water is prevented.

A formal approach, aimed at laboratories, to establishing control charts, and how to use them, appears in APHA (2005), in section 1020. The Australian Drinking-water Guidelines Information Sheet 3.4 (NHMRC 2011) offers a useful summary (in three pages) for water suppliers. Further guidance is offered in DWI (1999).

**Figure 17.7: Example of use of control limits**

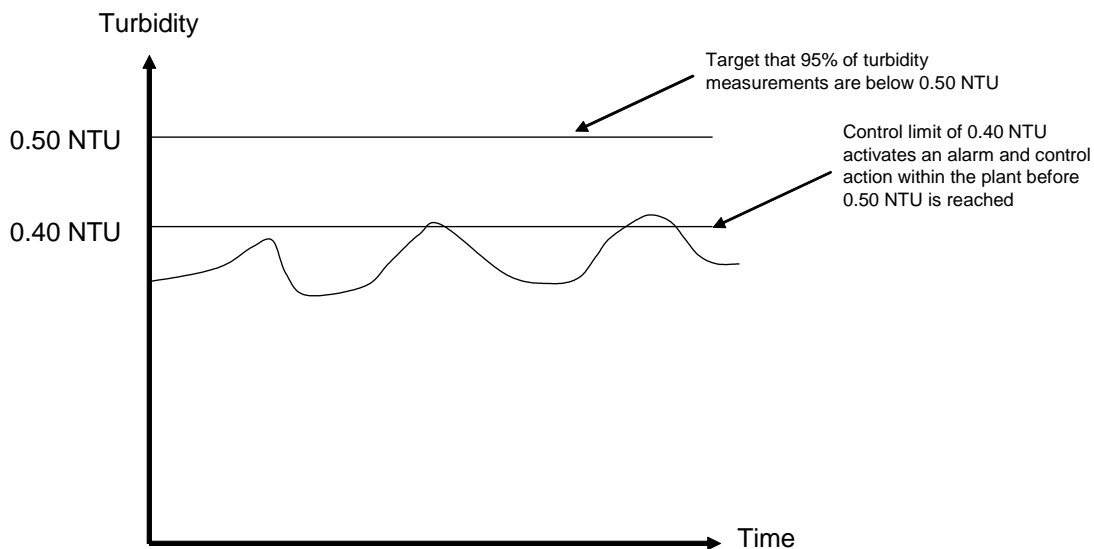



## 17.4.4 Recording and storing results

In order to prove compliance with DWSNZ there must be a continuous record of the relevant processes whilst in use. Clearly with digital data the record is actually a series of discrete data points. Continuous monitoring requirements for bacterial and protozoal compliance are defined in section 3.2 of the DWSNZ. As an example, records of filtered water turbidity are required to be no more than a minute apart, whereas five-minute intervals are acceptable for FACE in the water leaving the treatment plant. Obviously signal averaging time cannot exceed the recording period of one or five minutes, whichever applies.

The data are reported as the percent of time each condition was exceeded (or met) during the monitoring compliance period. Minimum measurement frequency and monitoring compliance periods are listed in the DWSNZ. There are also limits on the amount of time that instruments can be offline, see section 3.2 of DWSNZ.

Drinking water assessors will want to see a record showing that water quality complies with DWSNZ. Reliable storage of the data is an essential part of compliance. Maintaining data points for future analysis can pose a problem due to the amount of storage required. For example if turbidity is recorded every minute on each filter in a bank of four filters for one year, more than 2 million records are created for this parameter alone! It is permitted to compress the data if accuracy is maintained. In some plants this is achieved by only recording a value where that value has changed from the previous one, including recording if the instrument goes offline.

Water suppliers should consider the use of DVDs, CDs, USB memory sticks, external hard drives, Zip-drives or tape-drives for storage of data. Hard drives can be used to store data while manipulating or evaluating the data, but loss of data is likely to occur during a PC crash. Use of the above storage media types can overcome or minimise this problem.

The data must be stored in a usable format. Operators should have the ability to download data from their acquisition equipment into a usable and manageable format. Data is typically placed in one of many different formats such as Excel, Access, dBASE, and Lotus 123. Data should be converted into a format that can be used by the facility and by the assessor. Many water suppliers use software as above. The key to selecting a format is the ease with which the data can be viewed, manipulated, and or converted. Some software packages allow users to create reports, tables, or graphs based on the data.

**Table 17.3: Drinking-water Standards for New Zealand: requirements for continuous online monitoring**

| Treatment process                         | Turbidity             | Flow/<br>dose <sup>2</sup> | Temperature | pH                    | Disinfectant<br>residual | Other                    |
|---|-----------------------|----------------------------|-------------|-----------------------|--------------------------|--------------------------|
| Bacterial disinfection criteria           | Required <sup>1</sup> | Required <sup>1</sup>      | Or manual   | Required <sup>1</sup> | Required <sup>1</sup>    |                          |
| Protozoal compliance criteria             |                       |                            |             |                       |                          |                          |
| Bank filtration                           | Required <sup>1</sup> |                            |             |                       |                          |                          |
| Coagulation, sedimentation,<br>filtration | Required <sup>1</sup> |                            |             |                       |                          |                          |
| Coagulation, direct filtration            | Required <sup>1</sup> |                            |             |                       |                          |                          |
| Second stage filtration                   | Required <sup>1</sup> |                            |             |                       |                          |                          |
| Combined filtration                       | Required <sup>1</sup> |                            |             |                       |                          |                          |
| Individual filtration                     | Required <sup>1</sup> |                            |             |                       |                          |                          |
| Diatomaceous earth filtration             | Required <sup>1</sup> |                            |             |                       |                          |                          |
| Slow sand filters                         | Required <sup>1</sup> |                            | Or manual   |                       |                          |                          |
| Membrane filtration                       | Required <sup>1</sup> |                            |             |                       |                          | Direct<br>integrity      |
| Cartridge filtration                      | Required <sup>1</sup> |                            |             |                       |                          | Differential<br>pressure |
| Bag filtration                            | Required <sup>1</sup> |                            |             |                       |                          | Differential<br>pressure |
| Chlorine dioxide                          | Required <sup>1</sup> | Required <sup>1</sup>      | Or manual   |                       | Required <sup>1</sup>    |                          |
| Ozone                                     | Required <sup>1</sup> | Required <sup>1</sup>      | Or manual   |                       | Required                 |                          |
| UV  | Required <sup>1</sup> | Required <sup>1</sup>      |             |                       | UV intensity             | UV<br>transmittance      |

1 Refer to DWSNZ for specific requirements, as requirement varies depending on population served, etc; some manual testing may be acceptable.

2 Flow and dose calculated to enable C.t to be calculated. Refer to DWSNZ for specific online testing requirements for UV.

## 17.5 Testing

### 17.5.1 Introduction

This section discusses testing in a general sense. Obtaining a satisfactory test result presupposes a correct sample collection technique, and that the sample was placed in a container prepared for the purpose, or sterile container for microbiological testing. Some of these requirements are discussed generally in earlier sections of this chapter. A discussion on the use of statistics appears in the Appendix in Chapter 1. More specific sampling, preservation, transportation and testing procedures are provided elsewhere in these *Guidelines*, in appropriate chapters as follows:

- Chapter 2: Management of Community Supplies, section 2.4.3 Sampling frequency (for compliance)
- Chapter 4: Selection of Water Source and Treatment, sections 4.4.1 Where to sample, 4.3.2 When to sample and how often, and 4.4.3 What to sample
- Chapter 6: Bacterial Compliance (throughout most of the chapter)
- Chapter 8: Protozoa Compliance, section 8.6 Sampling and testing
- Chapter 10: Chemical Compliance, sections 10.3 Monitoring programme design, 10.4 Sampling procedures and techniques, and 10.5 Analytical details
- Chapter 18: Aesthetic Considerations, sections 18.4 Monitoring programme design, and 18.6 Analytical details.

Recommended test protocols are available, in detail, in publications such as *Standard Methods for the Examination of Water and Wastewater* (APHA). The requirements for a laboratory to be recognised by the Ministry of Health for compliance testing are outlined in Chapter 1: Introduction, section 1.3.10 Register of recognised laboratories.

This section deals with the process of testing in broader terms (eg, quality control) and the concepts and practices necessary to ensure that the testing is meaningful. This is important due to the time, effort and cost obtaining samples, the level of confidence needed in the results, as well as the public health risks a water supply can present. Some areas of repetition from previous sections have been inevitable. However, given the critical requirement of competency, such repetition is not amiss.

## 17.5.2 Appropriate testing

The critical requirement of any water testing protocol is that the testing be appropriate and competent. The monitoring and sampling efforts necessary to comply with the *Drinking-water Standards for New Zealand* (DWSNZ) are onerous and considerable in time, labour and expense. Such effort is wasted if the subsequent testing does not meet these requirements. It is implicit in the entire rationale of the monitoring process imposed by the DWSNZ that the samples collected are not just tested, but that they are tested properly.

Testing must not just be competent (ie, reliable, accurate and repeatable), but also appropriate. This means not just doing the tests right, but doing the right tests. This is necessary to ensure not just that the test process remains valid, but that test results (between time, place and laboratory) can be compared, and that it is possible to use the data for trend analysis if so desired.

There are several aspects to the concept of appropriate testing:

- testing only on valid samples, ie, samples having had proper sampling, transportation, storage and pretreatment procedures
- testing the exact parameter required. This is important, for example, in metals testing, where a number of forms of the metal can exist (total, soluble, particulate, acid digest, acid soluble) which require specific pretreatment and test methodologies to distinguish. It is important in microbiological testing too where options exist to distinguish various coliform types

- using a method with an appropriate limit of detection, see section 17.6. For example, the MAV for *E. coli* is less than 1 per 100 mL, so there is no point in testing a 50 mL aliquot for compliance purposes
- testing to the appropriate accuracy. This accuracy is essentially predetermined by the compliance values provided in the DWSNZ. For example, the MAV for lead is 0.01 mg/L, so testing with a method that has an uncertainty of measurement of 0.005 mg/L does not provide a very meaningful result, see also section 17.6.

The objective of the testing will usually indicate the determinand's form of interest, but it is often an area where experience and appropriate skill of the analyst will come into play, and where thought and consideration must be given to test options.

A number of determinands need to be tested on-site. This is usually because of determinand stability and the transportation time to reach the testing laboratory. The common example is testing of chlorine residuals where on-site testing is the only real option. The nature of such testing, sometimes with the use of simple test kits, may suggest a regime of testing where different standards apply. That is not the case. As far as compliance with the DWSNZ is concerned, such on-site testing is not just a screening procedure, or a rough check. It may lack the inherent accuracy of many laboratory tests but the same quality control requirements should apply. On-site results must be of known reliability, and they too must be traceable back to known reference standards.

If a laboratory's results are to be used to assess compliance with the DWSNZ, the laboratory must be a Ministry of Health recognised laboratory, ie, IANZ accredited, or a level 2 laboratory. Supplementary Criteria for Accreditation No. 1.2/2.2 defines the specific criteria for the approval of laboratories for entry into the Ministry of Health Register of Water Testing Laboratories; see IANZ (2007) for details. An accredited test report suggests that the laboratory met the requirements of IANZ, which does not necessarily include sampling. It is recommended that a document accompanying the test report include useful information such as the laboratory staff told the sampler how to collect and deliver the sample and provided the sampler with the correct equipment, and that the sample appeared to arrive in good condition; although that statement does not say the sample was handled correctly throughout the process, it does lend the test report a little more credibility.

### 17.5.3 Online monitoring

There can be obvious advantages in online instrumental monitoring:

- the immediacy of testing and of obtaining results
- the ability to use the results for direct plant control
- the ability to collect data without having to collect samples or to man sites
- the provision of continuous and recordable results.

Such monitoring can be more appropriate than manual methods, for example:

- where highly time-variable water quality fluctuations occur
- where and when it is difficult to sample manually
- where it is difficult to maintain the required sampling frequency
- variations between analysts are not a problem
- results can be more accurate when the manual method is difficult.

There can be economic advantages as well, despite what may be a fairly large capital outlay. Thus a wide range of on-site monitoring equipment is now available, and widely used, for an increasing number of test parameters.

However, while such testing can replace a degree of dependence on laboratory testing resources, the automated results should have a similar credibility to a result subject to the rigorous quality control regime that should prevail in an accredited laboratory environment. Thus a requirement exists that online monitoring equipment must be standardised properly and professionally certified at the time of installation, see section 17.3.3.

Also, because such instrument sensors can change over time (as a result, for example, of fouling, breakage, electronic drift, aging of electrodes), there must be sufficient regular standardisations and checks to ensure consistent and accurate performance. The verification process typically involves either instrument performance testing (essentially having the instrument read an independent standard), or by independent separate testing of a sample from the instrument against which its reading can be checked. Following the instrument manufacturer's instructions is a minimum requirement of the DWSNZ; this covers installation, operation, standardising with a zero and at least one other standard, and maintenance.

Instrument accuracy must be consistent with that required for any compliance monitoring function. Measurements from online instruments must agree with calibration or reference values within the predetermined uncertainty of measurement required.

Note that a record of each instrument standardisation (and indeed each maintenance and service event) must be retained as a retrievable, and auditable, document. Individual equipment requirements vary widely, though in all cases proper adherence to the manufacturer's instructions (as a minimum) is essential. Readers are directed to White (1997 and 1999) for an example (available on the internet) of a comprehensive field manual for automated water quality monitoring.

A public water supply in Portugal operated online monitoring equipment to monitor several parameters, including chlorine, pH, turbidity and conductivity. However, the quality of monitoring results was such that operators lacked confidence in readings and relied instead on manual sampling and laboratory testing. Through the WSP process, the WSP team focused on increasing the quality of data generated by the online instrumentation through improved calibration and maintenance, which resulted in greater confidence in readings and reduced reliance on laboratory testing. Also, the WSP risk assessment process revealed that some online instrumentation was unnecessary and could be removed from service. In addition, the frequency of

laboratory testing for other parameters (ie, those not monitored with the online equipment) was reduced on the basis of the outcomes of the risk assessment and prioritisation. As a result of WSP implementation, a 56 percent reduction in the cost of water quality monitoring was achieved through O&M costs avoided for the online instrumentation removed from service as well as reduced frequency of laboratory analysis (WHO 2018).

UK Guidance for online monitors used for compliance testing appeared in DWI (2010). In general, online monitors at water treatment works or service reservoirs may be used for regulatory analysis provided it can be shown that the particular monitor is:

- i. capable of providing fit for purpose data (as defined in regulation 16 or this Guidance)
- ii. sited to ensure that results are representative of the water being supplied
- iii. maintained and operated to a demonstrably high standard at all times
- iv. calibrated in a way that is valid, appropriate and traceable
- v. subject to reliable quality checks at an appropriate frequency
- vi. the date and time of each compliance reading is specified in advance of the start of the compliance year
- vii. there is a traceable means of demonstrating that the recorded reading is the true reading of the instrument at that time; and
- viii. there are robust and effective means for sampling and analysis whenever the monitor is out of service or performing unreliably.

Existing monitors for total chlorine, free chlorine, turbidity and conductivity may be demonstrated as meeting requirements (i) and (ii) above by comparing results of analysis using the current regulatory method with the instrument readings at the times of sampling. Provided the difference between the means is not greater than 10 percent of the result or 5 percent of the PCV, whichever is the greater, and the 95 percent confidence interval for the difference of an individual pair of results (difference between paired instrument result and compliance method result) is not greater than 20 percent of the result or 10 percent of the PCV, whichever is the greater, the results will be acceptable. Not fewer than 20 pairs of results covering at least one year should be used for the comparison. Only installations which satisfy these requirements may be used for compliance monitoring purposes.

DWI (2014) reports:

There is a paucity of dependable test data where online and laboratory measurements are compared in situations relevant to final water measurements at water treatment works. Based upon literature the following numerical conclusions were drawn.

- Chlorine – an uncertainty of about  $\pm 0.1$  mg/L Cl<sub>2</sub> against laboratory analysis is being achieved.
- Turbidity – uncertainty against laboratory analysis is better than  $\pm 0.2$  FTU, but due to the instrument-dependent nature of turbidity it may be more helpful to consider reproducibility and systematic error. The reproducibility is better than 0.1 FTU; the systematic error varies between instruments.

In all cases the performance derived from test data is significantly poorer than the suppliers' claimed performance.

## 17.5.4 Quality assurance, quality control and testing proficiency

The terms quality assurance and quality control are often used interchangeably. They have distinguishable meanings, particularly with regard to laboratory proficiency auditing and accreditation. Quality assurance (QA) refers to the system of operating protocols in a laboratory that, if strictly followed, will provide data of known and auditable quality. Separately, quality control (QC) is the laboratory's individual operational monitoring techniques and activities (within the QA system) used to check and ensure performance requirements.

A laboratory's QA system should be all-encompassing, and cover every aspect of laboratory activity including:

- management
- personnel
- equipment
- environment
- supplies
- test performance
- records
- reporting
- compliance with standards
- client relationships.

Such comprehensive (and auditable) quality assurance processes are a requirement of New Zealand's laboratory accreditation programme. This accreditation programme is intended to create a consistent and reliable level of laboratory testing performance nationally. Such performance is a necessity for good monitoring of any drinking-water standards and is supported by the system requirement of registered laboratories. Readers are referred to the referenced International Accreditation New Zealand (IANZ) publications for more detailed discussion of QA/QC, accreditation, and laboratory proficiency issues. Part 1000 of APHA (2005) contains useful information too.

IANZ accreditation provides confidence that:

- appropriate quality assurance systems are in place
- appropriate methods are being used for the tests the laboratory offers
- the methods used are either internationally recognised, or are properly validated in-house methods.

Through the site visits, IANZ assess whether the methods used are being carried out as stated. Site visits only 'sample' what is being done in the laboratory on an annual (or less frequently), so what accreditation cannot demonstrate is that the laboratory is following documented methodology on a daily basis. Even with accreditation in place, the production of reliable results from a laboratory, in the end, depends on the competence, diligence and integrity of the staff. The same is true of Level 2 labs.

Having a signatory, or head laboratory scientist, with appropriate expertise is important for ensuring that the correct response is made when dealing with situations that are not covered by the documentation. All that said, while accreditation does not guarantee the absence of inaccurate data, mistakes or corners being cut, it provides much greater assurance that such things are unlikely to happen than the lack of accreditation.

The outcome of the above is that a laboratory's test results should be of appropriate accuracy and reproducibility, and be able to be proven by audit to be so.

Laboratory accreditation bodies worldwide use proficiency testing schemes as part of the assessment process to validate the ability of laboratories to competently perform tests for which accreditation is held. Proficiency tests complement the traditional technique of an onsite laboratory review by technical experts.

IANZ operates the proficiency testing scheme in accordance to ISO/IEC Guide 43:1997, Proficiency testing by interlaboratory comparisons; Part 1: Development and operation of proficiency testing schemes.

The primary aims of proficiency testing schemes are:

- establishing the effectiveness and precision of test methods
- checking the individual testing performance of laboratory staff
- determining the characteristics of a material to a particular degree of accuracy (such as in the preparation of reference materials).

By participating in a proficiency testing scheme, laboratories will:

- identify any problem in the laboratory, eg, individual staff competence, method suitability, calibration of instrumentation, and initiate remedial action
- provide clients with additional confidence in the test results.

IANZ (2007) requires all laboratories in the MoH Register of Water Testing Laboratories to participate in suitable interlaboratory comparison programmes (ILCP) for those tests within their scope of recognition.

Ideally, ILCP samples should be part of a routine batch of analyses, all relevant determinands should be tested, and as many staff involved as possible. A very important part of ILCP is a timely follow-up, with a thorough investigation of all batches producing an unacceptable ILCP result. Outcomes should be available as part of staff training.



There may be occasions when a smaller scale interlaboratory comparison is appropriate, such as when establishing a new method, settling in new staff or equipment, or during problem solving. Splitting samples with an experienced nearby laboratory can be useful in such circumstances.

## 17.5.5 Accuracy, precision, uncertainty of measurement

An inherent part of a testing laboratory's QA and QC programme is prevention, detection and correction of errors in the measurement process. However, this aim is rarely completely achievable. The process can only minimise errors. Thus an extension of the quality control process is required to assess the errors remaining. In this way, a test result can be provided with an associated measure of its reliability. This is usually identified in terms of uncertainty of measurement or confidence limits that define the statistical certainty (often 95 percent) that the actual result lies within a given range, see section 17.6 for a more quantitative discussion.

Important components in limiting the uncertainty of a water test result may include some or all of the following:

- Method validation or verification (see section 17.5.6 for details)
  - analysis of reference standards or material
  - examination of published test performance data
  - appropriate limit of detection
  - eliminating interferences in the analysis
  - recovery of known additions
  - replicate analyses
  - independent method comparisons
- Laboratory analysis
  - testing samples in timely manner, or preserve them
  - calibration standards included with every batch
  - including appropriate sample and reagent blanks
- Quality control
  - internal performance audits
  - inter-laboratory proficiency testing programmes
  - control samples/charts
  - checking calculations
  - eliminating transcription errors.

Statistical data (usually in terms of standard deviation, or less commonly variance) from the above processes allow the measurement and monitoring of test method accuracy and precision. This reveals the basic reliability of a laboratory's test results, particularly in chemical testing. Microbiological testing has some differences in approach because of the absence of reference standard concentrations. Here methodology is primarily verified against both positive and negative control organisms.

The terms accuracy and precision have distinct meanings in the context of test results:

- accuracy refers to the proximity to the true or actual concentration value
- precision refers to the comparative similarity of repeat results.

IANZ (2004) defines three types of precision: repeatability, reproducibility and intermediate precision. These can be compared most easily in tabular form (Table 17.4).

**Table 17.4: Types of precision associated with test results**

| Parameter   | Repeatability | Intermediate precision | Reproducibility |
|-------------|---------------|------------------------|-----------------|
| Laboratory  | Same          | Same                   | Different       |
| Sample      | Same          | Same                   | Same            |
| Test method | Same          | Same                   | Same*           |
| Equipment   | Same          | Different              | Different       |
| Materials   | Same          | Different              | Different       |
| Time        | Same          | Different              | Different       |
| Staff       | Same          | Different              | Different       |

\* Note that by requiring test methods to be calibrated against a referee method or to be validated, acceptable reproducibility should be achievable nationally for purposes such as compliance testing.

When an analyst measures the concentration of a determinand in a sample several times in one batch, the repeatability can be calculated, which under these conditions will look rather good! Generally this will not reflect the precision obtained by a laboratory over time. A more realistic measure of the laboratory's precision is represented by intermediate precision. Reproducibility is more a measure of a test method's precision, as reflected by interlaboratory testing.

The test for precision, ie, measuring the standard deviation on one set of replicate samples (which is a measure of repeatability), can give misleading information in the situation where compliance with a national standard is being assessed over a very long period. A more reliable assessment of uncertainty of measurement includes a long-term assessment, or intermediate precision, which covers issues such as different analysts, the effect of new calibrations, new reagents, new equipment, etc. The situation may worsen if the water supplier uses more than one laboratory. On average, reproducibility has been found to be about double repeatability (Royal Soc Chem 2003).

A test method is said to be precise when repeated analyses on the same sample give similar results, but such results may not necessarily be accurate. An analogy with a dartboard is often made where a close cluster of darts represents precision, but with accuracy only being represented also when the cluster is around the bulls-eye, assuming that was the target.

Random errors (such as sample contamination, weight or volume uncertainties and calculation errors) are the main influence on precision, with a method being precise when random errors are small. Relatively small random error is advantageous in laboratory work since it allows reliably reproducible results to be obtained time after time. The results may still not represent the true value however. This depends on accuracy that is more derived from systematic errors (or bias) contributed by such factors as errors in standardising, interference, speciation and reagent contamination.

Ideally a test method should be both 100 percent precise and 100 percent accurate. However, given all the variables that can impact on test performance, this is very unlikely. Some systematic and random errors will still occur despite the minimisation of these through quality control measures. These will tend to be specific for any given test method and laboratory procedure, and they can be quantified by quality control components such as those listed above. Some (reference standards, independent method comparisons, inter-laboratory testing) identify systematic errors and accuracy, while others (sample replicates, different analysts, internal standards) identify random errors and precision.

Statistical treatment of the derived data (usually in terms of standard deviation) then quantifies total test performance error so that overall uncertainty of measurement can be available for any given result. This step of the quality control process is necessary before any result can be truly meaningful. Additionally, it can provide accept or reject criteria, used for example in test control charts, for individual test performance assessment.

It is not appropriate here to provide exact application guidelines for statistical treatment of test results. Various approaches are possible, and a brief summary is difficult. For examples of explanatory discussion of applications that are relevant to water testing, readers are directed to the very good IANZ Technical Guide (2004), APHA (2005), and Appendix 5 in ANZECC (2000).

When analysing a sample from a regular site for the first time, there are no previous results available for comparison. If all the major ions are analysed, the results can be checked by calculating the ion balance, or by comparing the measured conductivity with the calculated conductivity, see APHA (2005).

## 17.5.6 Referee methods, standards and traceability

For any given determinand, there is usually a range of test methods available. Sometimes this range is considerable. Different test methods might be preferred for a number of reasons such as:

- the concentration range of the determinand
- the form of the determinand
- presence of interfering substances
- accuracy required
- equipment available
- skill and qualifications of testing personnel
- sample stability
- time available before results needed
- cost
- convenience.

The overriding consideration must be that the method chosen can provide the required accuracy, limit of detection and uncertainty of measurement, and be 'fit for purpose'. The water supplier must define the objectives of the testing and discuss these with the analysts.

## Referee methods

Because different test methods often give different results (differing test conditions, forms of the determinand, reaction mechanisms, etc), comparison of results can lead to contention. This is certainly not desirable when compliance with a standard is being sought. For this reason referee methods have been identified for most test determinands in the DWSNZ. Referee methods first appeared in the DWSNZ in 1995 when there were several laboratories testing water in New Zealand, not all accredited by IANZ.

The DWSNZ are not updated very often, so the referee methods tend to become outdated. Therefore, apart from coliforms/*E. coli*, referee methods will probably not appear in future DWSNZ. Although the use of referee methods is currently encouraged, alternatives will be considered but the laboratory must have calibrated (section 17.5.7) or validated the alternative methodology against the referee method (IANZ 2007).

## Validation

Referee methods are usually taken from internationally accepted standard texts such as USEPA methods, APHA/AWWA/WPCF, ASTM, AOAC, ISO, etc. Methods that reach this 'status' have usually gone through a rigorous validation or peer review process. Individual laboratories can also validate a method, to the satisfaction of an accreditation body such as IANZ. They would normally do this when they have developed an analytical procedure of their own, or adapted a method not normally used for the same purpose.

Validation involves a successful examination of at least the following:

- i) repeatability, intermediate precision, with differences between the batches listed
- ii) recoveries from spiked and/or real samples, describing how this was carried out
- iii) matrix effects included for all matrices in the intended scope
- iv) comparison with alternative methods, interlab proficiency, reference materials
- v) method robustness, acceptance criteria established for conditions found to be critical
- vi) effect of determinand levels: acceptable ranges should be determined
- vii) uncertainty of measurement, method limits of detection, limits of quantitation etc
- viii) selectivity (interferences from other determinands)
- ix) linearity (over the intended range).

## Method verification

A laboratory using a referee method (sometimes called reference method) for compliance testing needs to demonstrate their competence in performing that method. This is called verification. The laboratory needs to show that it is fully compliant with the reference method. To claim it follows a particular reference method does, however, imply that it can match any method performance criteria given in the reference method, and this needs to be demonstrated and included in the report. This will include, at least, operating a QC programme, including satisfactory participation in an interlaboratory proficiency testing programme, and measuring detection limits and uncertainty.

## Standard materials

Ideally standard materials should be independent and certified, have known concentrations of determinands that, by analysis in the laboratory, allow the accuracy of test methods and procedures to be established. This is simply achieved by comparing the known value of the determinand in the standard material with the results obtained by the laboratory from its performed analysis of the standard material. Results should lie within the confidence limits identified for the reference standard material. Obviously the standard materials need to be in a similar concentration and matrix to the normal laboratory samples being processed.

A range of standard materials may be used:

- the most desirable are independently certified reference materials with stated determinand concentrations and confidence limits traceable to national or international standards. For water analyses, these can be obtained in a number of appropriate matrices, and with multi-determinand components. They are however relatively expensive and sometimes a lesser degree of certification may suffice
- the next level down is standard material prepared from (reputable) proprietary analytical grade chemicals
- a lesser form can be a large reservoir of a stable sample with known determinand concentrations from previous and confirmed analysis.

Important factors are that the reference material is certified to have a known true concentration and has not exceeded its warranty period, and is independent of the laboratory's calibration standards used in the routine test procedure. They should be used wherever possible. Use of standard materials, particularly certified reference materials, also provides testing laboratories with the added attribute of traceability. See Rienitz et al (2007) for a description of a technique for drinking-water interlaboratory comparisons.

## Traceability

Traceability can have two meanings within a water laboratory environment:

- the traceability of analytical results from the test report back to where the sample was collected. This traceability depends on such things as chain of custody records, sample identity, analyst identity, and test data and calculations

- the traceability of analytical results from the test report back to reference materials or calibrations, which can link ultimately with national or international standards.

Both are important test quality control requirements and are prerequisites for certification and accreditation of analytical laboratories.

## Chain of custody

The use of correct chain of custody procedures becomes very important when testing samples that may lead to a dispute or court appearance. Chain of custody traces the entire process of sample collection, delivery, storage, and the handling, testing and reporting procedures in the laboratory. Accredited laboratories should have adopted approved chain of custody practices for such occasions and they should be contacted for advice if required. The USEPA has produced a chain of custody 'procedure' which is available on the internet at:

**[http://www.epa.gov/region6/qa/qadevtools/mod5\\_sops/misc\\_docs/r1\\_chain-of-custody.pdf](http://www.epa.gov/region6/qa/qadevtools/mod5_sops/misc_docs/r1_chain-of-custody.pdf)**.

Utah State (2013) developed a Standard Operating Procedure (SOP) for sample Chain-of-Custody (CoC) based on the USEPA primer.

## 17.5.7 Calibrating a method against the referee method

The 2008 DWSNZ defined this as:

Demonstrating that an alternative method will reliably give the same result to an acceptable strength-of-agreement (NIWA 2007) as the referee method, under the same range of circumstances, within a known uncertainty considered acceptable by independent peer review, thus demonstrating that the alternative method is fit for purpose.

Section 3.1.1 of the DWSNZ stated that:

The referee methods specified in Appendix 2 are the definitive methods for demonstrating compliance with the DWSNZ. Alternative methods are acceptable but must have been calibrated against the referee methods, to the satisfaction of International Accreditation New Zealand (see NIWA 2007). In the event of any dispute about differences in analytical results, results obtained using the referee method will be deemed to be correct.

Infrequent revisions of the DWSNZ mean that the concept of referee methods is difficult to implement. The procedure for the approval of new test(s) used for drinking-water sample compliance was altered in December 2010; see

**<http://www.health.govt.nz/publication/ministry-health-procedure-approval-new-test-methods-bacteriological-compliance-testing-drinking>**:

Laboratories conducting tests for drinking-water compliance are either accredited by International Accreditation New Zealand (IANZ) or are recognised Level 2 laboratories. Laboratories conducting chemical tests may use the test methods for which they have been assessed by IANZ and found to be competent to perform, for the above compliance testing. Laboratories conducting bacteriological tests for drinking-water compliance need to use a referee method specified in the DWSNZ, or a method that has been calibrated against a referee method.

For new presence/absence bacteriological test methods, refer to the Ministry of Health procedure for approval of new test methods for bacteriological compliance testing of drinking-water samples using presence/absence methods (doc, 31.5 KB).

For numeric methods, refer to NIWA's 2007 report to the Ministry of Health: Equivalence measures for comparing the performance of alternative methods for the analysis of water quality variables (pdf, 246 KB).

The NIWA Concordance Calculator – a method for assessing agreement between alternative methods is recommended.

The NIWA report includes a calculator that allows users to determine the 'strength of agreement', which is classified into 'almost perfect', 'substantial', 'moderate' and 'poor'. The 'strength of agreement' must be fit for purpose. Ideally chemical methods will be 'almost perfect', but this will not always be possible, for example, when a MAV is close to the limit of detection.

Method validation and method verification are covered by IANZ in their *Specific Criteria for Accreditation*.

## 17.5.8 Reporting the results

Obviously there can't be a design or standard form because laboratories will be using different software packages, paper sizes, orientations, etc. But it is possible to say what should be included on the reports.

Some of the reporting requirements are specified in ISO 17025; for example, section 5.10.3 states that:

Test reports shall, where necessary for the interpretation of the test results, include the following:

- a. deviations from, additions to, or exclusions from the test method, and information on specific test conditions, etc, bearing in mind that reports need to contain all information necessary for the interpretation of the results (ISO 17025 section 5.10.1).

As a guide, Table 17.5 has been included to show the sort of information that should appear on a test report.

## 17.5.9 Records

Section 13 of the DWSNZ (2005, revised 2008) stated that:

The duty to keep records and make them available is covered in section 69ZD of the HDWAA (2007). See Health Act: <http://www.legislation.govt.nz/>.

This begins:

Every drinking-water supplier and every temporary drinking-water supplier who is required to prepare a WSP must ...

Section 69ZD(2)(g) states that the records kept must include details of the monitoring of that drinking-water; and (h) covers customer complaints.

Water suppliers only need to store information on the compliance monitoring results and the method used, not the field sheets, chain of custody documents, work sheets, QA/QC data, etc. The required information should appear on the laboratory result sheet.

The above applies to water suppliers, and does not apply to testing laboratories – their requirements are covered by their accreditation or conditions related to being a 'recognised laboratory', ie, covered by IANZ. *Supplementary Criteria for Accreditation No. 1.2/2.2* (IANZ. 2007) which covers laboratories recognised by the MoH states in section 12.1:

The laboratory shall maintain a record system to suit its particular circumstances and comply with any particular regulations. It shall retain on record all original observations and calculations and a copy of the test report for an appropriate period. The records for each test shall contain sufficient information to permit their repetition. Where appropriate, records of derived data and of calibration records shall also be retained for an appropriate period.

There is no reference to how long records should be retained. There had previously been some indication that a minimum of 10 years was required as stated in The Health (Retention of Health Information) Regulations 1996; however, these Regulations only relate to health services provided to, and information about, individuals.

**Table 17.5: Suggested report form**

**WAIRARAPA TECHNICAL SERVICES LTD**  
**PO Box 125, Masterton**

Analytical Services Division  
Chief Chemist: Brian Jones  
phone 06 235 1457  
fax 06 235 1458  
b.jones@wts.co.nz

Report dated 12.11.06

Space for IANZ 'stamp' if appropriate

**A Ministry of Health recognised laboratory**

Number of pages: 2



## b) Sample information area

Client: South Wairarapa District Council  
Water supply: Martinborough MAR003

| Samples         | WINZ     | Lab no     | Sampled               |
|-----------------|----------|------------|-----------------------|
| Treatment plant | TP01234  | 2006/11/06 | 1015, 8 November 2006 |
| 17 High Street  | MAR001HS | 2006/11/07 | 1030, 8 November 2006 |
| Rugby Club      | MAR001RC | 2006/11/08 | 1045, 8 November 2006 |

Samples collected by G Brown, Swimming Pool Services Ltd, Carterton.

Sample(s) arrived at laboratory at 1130, 8 November.

## Sample details

- E. coli*: in sterile borosilicate bottles with thiosulphate, 5.2°C on arrival
- For other tests: each sample in 2 x 2 L PE bottles supplied by lab, one sample straight from the tap, the other pre-acidified with 5 mL 50 percent HNO<sub>3</sub>.

Sampler's comments: fine this am, 35 mm rain fell previous day.

Analyst's comments: samples arrived in satisfactory condition for compliance testing purposes.

## c) Analytical information area

| Test           | Test method                | Detection limit | Uncertainty |
|----------------|----------------------------|-----------------|-------------|
| <i>E. coli</i> | APHA 9223B                 | NA              | NA          |
| pH             | APHA 4500-H <sup>+</sup> B | NA              | NA          |
| Turbidity      | APHA 2130 B                | 0.05            | 0.05        |
| Manganese      | APHA 3111 B                | 0.005           | 0.01        |
| FAC            | APHA 4500-Cl G             | 0.02            | 0.03        |

## d) Test results area

| Sample   | Test tested    | Unit result         | Date        | Test                | MAV |
|----------|----------------|---------------------|-------------|---------------------|-----|
| TP01234  | <i>E. coli</i> | per 100 mL          | 8 November  | <1                  | <1  |
| TP01234  | pH             | 8 November          | 7.95        | –                   |     |
| TP01234  | Turbidity      | NTU                 | 9 November  | 0.25                | –   |
| TP01234  | Manganese      | g/m <sup>3</sup> Mn | 11 November | 0.12 * <sup>1</sup> | 0.4 |
| TP01234  | FAC            | g/m <sup>3</sup>    | 8 November  | 0.35 * <sup>2</sup> | 5   |
| MAR001HS | etc ...        |                     |             |                     |     |
| MAR001RC | etc ...        |                     |             |                     |     |

\* 1 Less than the MAV but exceeds the GV (0.04 mg/L).

\* 2 Tested in the field by Swimming Pool Services Ltd, a MoH recognised laboratory.

Signed (Brian Jones – IANZ signatory)  
Wairarapa Analytical Services Limited

# 17.6 Comparing test results against a MAV

## 17.6.1 Uncertainties of measurement

ISO 17025 requires:

Testing laboratories shall have and shall apply procedures for estimating uncertainty of measurement. In certain cases the nature of the test method may preclude rigorous, metrologically and statistically valid calculation of uncertainty of measurement. In these cases the laboratory shall at least attempt to identify all the components of uncertainty and make a reasonable estimation, and shall ensure that the form of reporting of the results does not give a wrong impression of the uncertainty. Reasonable estimation shall be based on knowledge of the performance of the method and on the measurement scope and shall make use of, for example, previous experience and validation data.

Measurements are not exact. They are attempts at establishing the true value of a determinand, but because of numerous factors that influence the measurement in random ways (ie, excluding factors that bias the results), the measured value can only be an approximation of the true value. The statement of a test result alone, therefore, is incomplete. Information about the uncertainty in the measurement is needed in order to provide an understanding of how close to the true value the test result is likely to be. A good estimate of uncertainty of measurement allows laboratories and their clients to:

- establish that results are fit for purpose
- confirm that results are traceable to international or national standards
- properly compare results between laboratories
- compare results with specifications, legal tolerances or regulatory limits
- make informed decisions.

The uncertainty in a test result is stated as a  $\pm$  value, termed the confidence interval. The bounds of this interval are called the upper and lower confidence limits, respectively. Usually the interval is symmetrical about the test result (and is assumed always to be so in this section). So the limits are the test result  $\pm$  the 'confidence interval half-width'.

The size of the half-width depends on experimental factors, such as the sensitivity of the instrument, the analytical method used, the skill of the analyst etc, the required level of confidence, and the number of measurements made on the sample (see section 17.5). An estimate of the spread in the values caused by the experimental factors can be obtained by making repeated measurements of a determinand. This spread is often expressed as the standard deviation, and is one of the parameters used to calculate the confidence limits.

The level of confidence determines the likelihood that the true value will be within the confidence interval. The greater the confidence required, the larger that interval will be. Conversely, replicated analyses will tend to have smaller confidence intervals. The DWSNZ requires a 95 percent level of confidence where possible for the purposes of evaluating compliance.

Note that there is never 100 percent certainty that the true value will lie within the confidence limits; from time to time the true value will lie outside these limits. For example, if the level of confidence is set at 95 percent, this implies that there is a 5 percent probability that the true value will lie either below the lower limit or above the upper limit.<sup>1</sup>

The confidence limits (CL) can be determined from Equation 17.1:<sup>2</sup>

$$CL = \bar{y} \pm 1.960 q \frac{s_r}{\sqrt{n}} \quad \text{Equation 17.1}$$

where:

- $\bar{y}$  = the laboratory result for a particular sample; there is usually just one result, so usually  $\bar{y} = y$  (a single result is its own mean)
- $s_r$  = the standard deviation of a set of quality control samples<sup>3</sup>
- $n$  = the number of independent measurements made on the sample
- $q = \sqrt{\frac{n+m}{m}}$  where  $m$  is the number of independent blank determinations used to obtain the result.

Often, a sample result is obtained by subtracting a reading of one or more blanks from a reading of one or more measurements on a sample. Frequently, there is a single sample analysis, and a single blank, so that  $n = m = 1$ . When an analysis does not involve a blank subtraction (eg, instrumental turbidity measurements, or when it is believed that the analytical technique will not produce a non-zero result if the determinand is absent). In that case  $m = 0$  and so the  $q$  correction factor is simply  $q = 1$ .

For example, say we have previously performed a number low-level replicates of lead analyses, obtaining a standard deviation of  $s_r = 0.0010$  mg/L. If the result is based on a single sample analysis, from which a blank result is subtracted, then  $q = \sqrt{[(1+1)/1]} = \sqrt{2} = 1.414$  and the confidence interval lies a distance of 0.0028 mg/L on either side of the sample result.<sup>4</sup>

<sup>1</sup> Strictly, this is taking a Bayesian interpretation of probability, using uniform prior distributions (McBride 2005). The details need not concern us further.

<sup>2</sup> The approach given here is based on material in Hunt and Wilson (1984, section 8.3). It assumes that: (a) the standard deviation  $s_r$  equals the 'population' standard deviation and is known from an historical set of results for blank (or low level) samples, and (b) the distribution of the population of blanks and/or low level samples are 'normal'. The '1.960' factor is the value of the abscissa of the unit normal distribution that cuts off an area of 0.025 in each tail of that (symmetrical) distribution. (The 'unit normal distribution' is the ordinary normal, bell-shaped, distribution, with zero mean and unit standard deviation.) Note that some authors (eg, IANZ 2004) advocate the use of the  $t$  distribution in place of the unit normal distribution. However there are some conceptual difficulties in that approach (see Hunt and Wilson 1984, p 295).

<sup>3</sup> These repeated measurements are not made on the sample in question.

<sup>4</sup> Calculated as  $1.960 \times (0.0010 / \sqrt{1}) \times 1.414 = 0.0028$ .

IANZ accredited and MoH recognised laboratories will routinely make quality control measurements that allow them to calculate their measurement methods' limits of detection and uncertainties. The most balanced measurement of uncertainty uses intermediate precision; see section 17.5.5 and IANZ (2004). Factors involved in calculating the measurement of uncertainty vary depending on the nature of the analysis, see (IANZ 2004). A discussion on how to avoid underestimating uncertainty appears in RSC (2012). For some other helpful discussion, see <http://www.rsc.org/Membership/Networking/InterestGroups/Analytical/AMC/TechnicalBriefs.asp/>.

Uncertainty of measurement can vary with concentration. In terms of compliance with the DWSNZ, it is important to know the uncertainty of measurement for concentrations near the MAV. With respect to compliance, the importance of uncertainty of measurement reduces when the test result is small compared with the MAV.

With respect to the DWSNZ, uncertainty of measurement does not have to be reported with results of operational requirements used for compliance testing. This is because of the wide range of instruments in use, and because the concept of uncertainty in this field is still developing. The DWSNZ simply require that 'equipment used to demonstrate compliance must be suitable for that purpose'. Operational requirements include online or manual testing of pH, turbidity, temperature, FAC, pressure differential, chlorine dioxide, ozone, UV irradiance (sensor reading), UV transmission, and direct integrity (as used on MF plants).

## 17.6.2 Comparison of a measurement with a fixed value

The calculation of the confidence limits for a measurement is important for the reasons discussed above. However, Equation 17.1 has to be modified slightly if upper or lower confidence limits are to be calculated for comparing test results against a fixed value. This is what is required when establishing if a MAV or operational requirement has been transgressed.

Either a precautionary or a permissive approach can be taken when making this comparison. Just which approach is followed depends on the stance taken by the regulatory authority on the burden of proof. This is discussed in the following sections (and more fully by McBride 2005).

The precautionary approach, which is taken by most public health authorities around the world, assumes 'guilty until proven innocent beyond reasonable doubt', ie, there must be 95 percent confidence that the fixed value has not been exceeded, for compliance to be inferred. For this requirement to be met, the upper confidence limit must not exceed the fixed value.

The permissive approach, on the other hand, assumes 'innocent until proven guilty beyond reasonable doubt', ie, it seeks 95 percent confidence that the fixed value has been exceeded, before it is classed as having been exceeded. Thus exceedence is only deemed to have occurred once the lower confidence limit (*LCL*) exceeds the fixed value.

The upper confidence limit (*UCL*) is calculated using Equation 17.2:

$$UCL = \bar{y} + 1.645 q \frac{s_r}{\sqrt{n}} \quad \text{Equation 17.2}$$

The parameters are the same as in Equation 17.1, but because a comparison is being made with a fixed value this is a 'one-sided' limit. That is why the value '1.960' in Equation 17.1 has been changed to '1.645' in Equation 17.2.<sup>5</sup>

The lower confidence limit (*LCL*) is calculated in a similar manner, simply replacing the plus sign by a minus sign. That is:

$$LCL = \bar{y} - 1.645 q \frac{s_r}{\sqrt{n}} \quad \text{Equation 17.3}$$

Continuing the lead example above (section 17.6.1), the one-sided confidence limits would lie a distance of 0.0023 mg/L from the sample result.<sup>6</sup> The *UCL* would be above the sample result and the *LCL* would be below that result.

### 17.6.3 Approaches considered in developing the method used in the DWSNZ

Three approaches to the way in which results can be compared against MAVs and operational requirements were considered in establishing the requirements of the DWSNZ.

#### Approach 1: Ignore uncertainty in the test measurement

In this approach the face value (ie, the result without uncertainty of measurement considered) is compared directly with the MAV. No attempt is made to take the uncertainty of measurement into account. So, for example, a result for lead of 0.012 mg/L is a transgression, because it exceeds the MAV of 0.01 mg/L. If the uncertainty in the test measurement were, say,  $\pm 0.003$  mg/L, the true result could occasionally be below 0.009 mg/L, but this would make no difference to the finding that the result transgresses the MAV.

This approach relies on the balance of probabilities, taking an even-handed approach to swings and roundabouts for fairness. So when the measured value is just above a MAV, there is about a 50:50 chance that the true value is below it, and vice versa in the case that the measured result is just below the MAV.

<sup>5</sup> An abscissa of 1.645 cuts off an area of 0.05 in the right tail of the unit normal distribution.

<sup>6</sup> Calculated as  $1.645 \times (0.0010 / \sqrt{1}) \times 1.414 = 0.0023$ .

A major advantage of the approach is its simplicity.

## Approach 2: Round up or down

This approach compares test results with MAVs and operational requirements using the same number of significant numbers, so, using the example in Approach 1, the test result of 0.012 mg/L can be rounded down to 0.01 mg/L, which is not greater than 0.01, so it is not a transgression.

This is effectively a permissive approach. That is, the result has to be some way over 0.01 mg/L before it fails the MAV. For example, a lead result of 0.0149 mg/L in this approach would comply with a 0.01 mg/L MAV, despite being 49 percent greater than the MAV. A result of 0.0151 mg/L would be a transgression. This rounding approach also ignores uncertainty in test measurement.

## Approach 3: Accept uncertainty in the test measurement

To be implemented properly this approach requires the uncertainty of measurement to be based on either the upper or lower one-sided 95 percent confidence limit to be calculated using Equation 17.2, and for a decision to be made whether a precautionary or permissive approach should be taken, as discussed in section 17.6.2. Considering an example of a measured lead concentration being 0.012 mg/L, then, using the results we have already calculated, the two approaches would have the following consequences:

- a) **Permissive:** If this approach is taken, we use the result we calculated earlier (that the LCL lies 0.0023 below the result), to obtain  $LCL = 0.0097$  mg/L. Therefore, the result is not classed as a transgression, because LCL is less than the MAV (0.01 mg/L). For simplicity, in this example it is assumed that the uncertainty of measurement and LCL have the same value.
- b) **Precautionary:** If this approach is taken, we use the result we calculated earlier (that the UCL lies 0.0023 above the result), so that  $UCL = 0.0143$  mg/L. Or had the measured lead concentration been 0.0085 mg/L, then the  $UCL = 0.0108$  mg/L, which is above the MAV despite the test result being below the MAV of 0.01 mg/L. For simplicity, in this example it is assumed that the uncertainty of measurement and UCL have the same value.

The precautionary approach has been used in all previous editions of the DWSNZ for *E. coli* or faecal coliforms. This approach has been continued in the DWSNZ 2005 (revised 2008). For example, Table A1.4 in the DWSNZ expresses the permissible number of exceedances of a MAV, given the need to have 95 percent confidence that the MAV is exceeded for no more than 5 percent *of the time*. The proportion of allowable exceedances *among the samples* is always less than 5 percent, as it must be in a precautionary approach.<sup>7</sup> For example, one exceedance is allowed among 100 samples, a proportion of 1.0 percent, and six exceedances are allowed among 240 samples, a proportion of 2.5 percent.

<sup>7</sup> If 5 percent *of samples* exceed the MAV there would be about a 50 percent chance that the MAV would have been exceeded for more than 5 percent *of the time*. That is a 'face-value' stance to the burden-of-proof, not a precautionary approach.

## 17.6.4 Approach adopted in the DWSNZ

The DWSNZ 2005 (revised 2008) state that no account is to be taken of uncertainties of measurement in chemical test results when comparing them against MAVs. This is in line with previous practice.

However, NZS ISO/IEC 17025:2005 requires laboratories to calculate their uncertainty of measurement, which is explained in IANZ Technical Guide TG5 (IANZ 2004). When testing drinking-water for chemical compliance, laboratories must report their uncertainty of measurement (U) with the test result (T). A MAV has been exceeded when the test result (T) is higher than the MAV.

Most MAVs include a safety factor because of the uncertainty associated with the toxicological data. Consequently almost all are stated to only one significant figure. Despite this, MAVs are treated as exact numbers for the purposes of comparing them with test results. In other words, as many zeros as required can be placed after the last significant figure of the MAV when comparing it with a test result.

Roberts (2007) stated:

With the exception of some sections of the forensic fraternity, Australian regulators have not yet formally embraced the concept of measurement uncertainty (MU) or determined policies and rules for interpreting it with reference to regulatory limits. Some would argue that the limits established take MU into account, but in most cases the inaction is akin to adopting a policy to disregard MU. It is fair to say that to-date MU has had limited impact on regulatory standards in Australia. This is likely to change in the future. Both chemists and regulators would be well-advised to improve their understanding of MU.

In the future, the precautionary approach, ie, Approach 3(b) may well be used in determining whether a test result exceeds the MAV. The upper one-sided 95 percent confidence limit could be termed the adjusted result. Therefore it would be the adjusted result, and not the test result that will be compared against the MAV. If this adjusted result exceeds the MAV, a transgression will have occurred. For example:

If the uncertainty of measurement based on the upper one-sided 95 percent confidence limit (ie, adjusted result of  $U + T$ ) in a lead measurement lies 0.002 mg/L units above the measured value, then the test result cannot exceed 0.008 mg/L, otherwise the true value may too often exceed the MAV of 0.01 mg/L.

## 17.6.5 Detection

Various techniques are used to describe the lowest meaningful concentration a test method can report. Sometimes the terminology is used rather loosely, so it is important to explain exactly what is meant when discussing detection.

APHA (2005) refers to instrument detection level, lower limit of detection, method detection level, and the level of quantification. The relationship among these levels is approximately 1:2:4:10.

IANZ (2004) refers to criterion of detection, limit of detection and limit of quantification. The relationship of these to the standard deviation of low-level results is approximately 1:1.7:3.4:8.

These seven different relationships vary depending on whether blanks are included and whether the sample is tested more than once. Most laboratories in New Zealand use the expressions in IANZ (2004), which tend to be based on UK and European practices.

The criterion of detection (*CofD*) is the minimum concentration that a single test result may have for the analyst to say that the determinand is present with 95 percent confidence. The limit of detection (*LofD*) is the upper confidence limit for a result that is exactly on the *CofD*.

The *CofD* is defined as  $2.33s_r$ , and the *LofD* is defined as  $4.65s_r$ .<sup>8</sup> As an example, consider a determinand with  $s_r = 1.2$  mg/L. Then *CofD*  $\approx 2.8$  mg/L and *LofD*  $\approx 5.6$  mg/L. The data series 4.5, 3.4, 3.0, 2.5 and 8.9 mg/L would be reported as 4.5, 3.4, 3.0, <5.6 and 8.9 mg/L. There is an apparent inconsistency here: some results are reported as less than the *LofD*, while some are (validly) censored and reported as numerical values less than that limit. What's happening is that the numerically-reported results are 'central estimates' of the true concentrations, whereas in the censored results the *LofD* is playing the role of an upper one-sided 95 percent confidence limit.

It should be noted that the censoring practice advocated in these *Guidelines* (in the preceding paragraph) is not followed routinely, it often being common to use only the *LofD*, often taken as  $3s_r$  (eg, Eurachem 1988, Helsel 2005),<sup>9</sup> or other multiples of  $s_r$  (APHA 2005, IANZ 2004). In such approaches, any data above this limit are reported at face-value, those below it are reported less than the *LofD*. The problem with that is that if the true concentration happens to equal the *LofD*, 50 percent of the time the result will be 'not detected', or less than the *LofD* value. In contrast, the approach adopted in these *Guidelines*, using both the *CofD* and *LofD*, avoids that problem and has a strong theoretical foundation, especially for reporting compliance data.<sup>10</sup>

<sup>8</sup> These limits are based on keeping 'Type I' and 'Type II' statistical errors below 5 percent, for blank-corrected analyses. The rationale is as follows. If an analyst *observes* a blank-corrected value greater than *CofD* there is at least a 95 percent chance that it was in fact present. Furthermore, if the *true* concentration is greater than the *LofD* there is at least a 95 percent chance that the *observed* concentration will be above the *CofD*, thereby allowing detection to be claimed. Theoretical details can be found in Hunt and Wilson (1984), Ellis (1989) and McBride (2005). Note that if the analysis does not involve a blank-correction, the multipliers 2.33 and 4.65 for the *CofD* and *LofD* should be divided by  $\sqrt{2}$ , and so become 1.65 and 3.29 respectively. The latter figure is used in 'Standard Methods' (APHA 2005, pp 1–18), ie, ignoring the increased variability attributable to blank corrections.

<sup>9</sup> This divergence of practice is made more complex by a lack of uniformity in nomenclature, with one writer's *CofD* being called a Limit of Detection by others.

<sup>10</sup> The *CofD/LofD* approach given above involves 'informative censoring' (Helsel 2005). This can raise problems for some sophisticated data analyses (even for calculation of percentiles), but this is not an issue for compliance monitoring. Ellis (1989, Appendix 4B) presents some solutions to these difficulties.



Note also that this approach does not consider the Limit of Quantitation (LofQ), which is often taken as about  $10s_r$ . Data above this limit can be held to have satisfactory measurement precision.

Finally, note that the *CofD* and *LofD* are independent of a particular test result. They refer to an expected performance of a laboratory or instrumental technique on average, not to any feature of a particular result.

## MAVs and detection limits

Many chemical MAVs and operational requirements are close to common analytical limits of detection. The test methods need to be sensitive and precise enough to prevent large uncertainties. The detection limit needs to be less than the operational requirement or 50 percent of the MAV (to allow Priority 2 status to be assessed). That is, reporting a lead analysis as less than 0.1 mg/L, for example, is unsatisfactory because the result could be 0.09 mg/L, which is nine times its 0.01 mg/L MAV.

As far as possible, the limit of detection for tests should be *at most* a fifth of the MAV or operational requirement, eg, no more than 0.002 mg/L for lead, 0.06 NTU for a turbidity operational requirement of 0.30 NTU, or 0.02 NTU for an operational requirement of 0.10 NTU.<sup>11</sup> It is the responsibility of the water supplier to be vigilant when selecting a laboratory and/or method to ensure that *LofDs* are well below the MAV to eliminate the possibility of encountering an exceedance based on uncertain data. How to deal with “less than values” or “non-detects” is discussed in the Appendix of Chapter 1, and in Section 10.2.5.3 of the Guidelines.

Where a water supplier has control over a determinand such as turbidity, it would be wise to put control limits in place that signal a need for corrective action to be taken at levels well below the MAV or operational requirement; see section 17.4.3.

## Measuring the limit of detection

Ideally, all water suppliers (and/or water laboratories) should use the same approach for estimating the criterion and limit of detection (*CofD* and *LofD*). The following is recommended.

Select a low level standard (for example, a standard at about five times the expected *LofD*) and test it many times, preferably over several days; large laboratories could conduct the test using different instruments and staff. This will need to be repeated when new staff conduct the test, and when new methods or instruments are introduced. Conducting repeat analyses on a single sample on a single occasion is called repeatability. Different people testing different samples, on different occasions etc is called intermediate precision; see section 17.5.5. Say the following results were obtained from testing a 0.001 mg/L standard (eg, lead or aldicarb):

<sup>11</sup> Making the detection limit one-tenth of the detection limit is much more desirable.

|        |        |        |        |        |        |
|--------|--------|--------|--------|--------|--------|
| 0.0010 | 0.0012 | 0.0010 | 0.0010 | 0.0011 | 0.0018 |
| 0.0018 | 0.0014 | 0.0009 | 0.0009 | 0.0010 | 0.0019 |
| 0.0002 | 0.0011 | 0.0014 | 0.0014 | 0.0008 | 0.0018 |
| 0.0004 | 0.0008 | 0.0015 | 0.0015 | 0.0007 | 0.0015 |
| 0.0010 | 0.0005 | 0.0016 | 0.0016 | 0.0010 | 0.0013 |
| 0.0015 | 0.0004 | 0.0017 | 0.0017 | 0.0010 | 0.0011 |
| 0.0010 | 0.0006 | 0.0015 | 0.0015 | 0.0013 | 0.0008 |
| 0.0012 | 0.0009 | 0.0013 | 0.0013 | 0.0013 | 0.0006 |

Using a spreadsheet such as Excel, the above results have a standard deviation ( $s_r$ ) of 0.00041 mg/L (mean 0.00116 mg/L). Therefore CofD = 0.00068 mg/L and LofD = 0.00134 mg/L, when using CofD = 1.65  $s_r$  and 3.29  $s_r$  respectively, ie, no blank corrections used. These could be rounded off to 0.007 and 0.0013 mg/L respectively.

Ideally the LofD should be a fifth of the MAV, or lower. There may be situations where the analytical technique of a determinand is not particularly sensitive, and may have a LofD that is close to the MAV. This may result in the reported value exceeding the MAV, thereby requiring a water treatment process that will reduce the concentration of the determinand to an unnecessary level.

There are some techniques that can be adopted that may overcome this problem. Some of these will increase the cost of analysis, but this cost will be very small compared with the cost of installing additional treatment. Some approaches include:

- using a different analytical technique with a lower LofD
- concentrating the sample, say by boiling 200 mL down to 20 mL
- running replicate tests on the water sample.

## References

ANZECC. 2000. *Australian Guidelines for Water Quality Monitoring and Reporting*. Australia and New Zealand Environmental and Conservation Council.  
<http://www.environment.gov.au/water/publications/quality/nwqms-monitoring-reporting.html>.

APHA. 2005. *Standard Methods for the Examination of Water and Wastewater* (21st edition). Washington: American Public Health Association, American Water Works Association, Water Environment Federation.

ANZECC/ARMCANZ. 2000. *Australian Guidelines for Monitoring and Reporting, National Water Quality Management Strategy Paper No 7*. Australia and New Zealand Environment and Conservation Council / Agriculture and Resource Management Council of Australia and New Zealand.  
<http://www.environment.gov.au/water/policy-programs/nwqms/>.

AS/NZS 5667. 1998. *Water Quality – Sampling*. Homebush, NSW: Standards Australia, and Wellington: Standards New Zealand.

- AS/NZS 2031. 2001. *Selection of Containers and Preservation of Water Samples for Microbiological Analysis*. Standards Association of Australia.
- AWWA. 2001. *Concrete Pressure Pipe* (3rd edition). AWWA Manual M2. Denver CO: American Water Works Association.
- AWWA Manual. *Instrumentation and Control*. Denver CO: American Water Works Association. [www.awwa.org](http://www.awwa.org).
- British Standards Institution. 2010. *Guide for the Auditing of Water Quality Sampling*. BS 8550:2010.  
<http://shop.bsigroup.com/en/ProductDetail/?pid=00000000030169965>.
- Colton J. 2015. Online compliance, a decade of lessons. *Water* 191: 36–8. Water New Zealand, September/October.
- DWI. 1999. *Guidance on the Interpretation of Aspects of Analytical Quality Control (AQC)*. 8 pp. <http://dwi.defra.gov.uk/stakeholders/guidance-and-codes-of-practice/index.htm>.
- DWI. 2010. *Guidance on the Implementation of the Water Supply (Water Quality) Regulations 2000 (as amended) in England*. 99 pp.  
[http://dwi.defra.gov.uk/stakeholders/guidance-and-codes-of-practice/WS\(WQ\)-regs-england2010.pdf](http://dwi.defra.gov.uk/stakeholders/guidance-and-codes-of-practice/WS(WQ)-regs-england2010.pdf).
- DWI. 2014. *A Critical Appraisal of Existing Guidance on Online Monitor Performance Data*. Report No: UC9882. 184 pp. <http://dwi.defra.gov.uk/research/completed-research/reports/DWI70-2-285.pdf> or <http://dwi.defra.gov.uk/>.
- DWI. 2016. *Private Water Supplies Sampling Procedures Manual*. Drinking Water Inspectorate (UK). 29 pp. <http://dwi.defra.gov.uk/private-water-supply/regs-guidance/Guidance/sampling/pws-sampling-procedures.pdf>.
- Ellis JC. 1989. *Handbook on the Design and Interpretation of Monitoring Programmes*. Medmenham, England: Water Research Centre Report NS29. Section 8.2.3 and Appendix 4-B. Revised in 1996 as *Water Quality Monitoring: A practical guide to the design and implementation of freshwater quality studies and monitoring programmes*. UNEP/WHO, 366 pp. <http://www.bvsde.paho.org/bvsacd/who/monito.pdf>.
- Eurachem. 1998. *The Fitness for Purpose of Analytical Methods: A laboratory guide to method validation and related topics*. Teddington, Middlesex, UK: Eurachem.  
<http://www.eurachem.nl/images/eurachem/Fitnessforpurpose.pdf>.
- Helsel DR. 2005. *Nondetects and Data Analysis: Statistics for censored environmental data*. New York: Wiley. 288 pp.
- Hunt DTE, Wilson AL. 1986. *The Chemical Analysis of Water: General principles and techniques* (2nd edition). Section 8.3. London: The Royal Society of Chemistry.  
<http://pubs.rsc.org/en/Content/eBook/978-0-85186-797-7>.
- IANZ. *Specific Criteria for Accreditation*. Lab C 1: Biological Testing. Lab C 2: Chemical Testing. For latest versions, see <http://www.ianz.govt.nz/>.
- IANZ. 2004. *Technical Guide: Uncertainty of measurement precision and limits of detection in chemical and microbiological laboratories*. Auckland: International Accreditation New Zealand. See <http://www.ianz.govt.nz/>.

IANZ. 2005. *General Requirements for the Competence of Testing and Calibration Laboratories*. (NZS/ISO/IEC 17025). Auckland: International Accreditation New Zealand. <http://www.ianz.govt.nz/>.

IANZ. 2007. *Supplementary Criteria for Accreditation No. 1.2/2.2* (2nd edition). Ministry of Health Register of Water Testing Laboratories. Auckland: International Accreditation New Zealand. August. See: <http://www.ianz.govt.nz/>.

ISO / VIM. 1993. *International Vocabulary of Basic and General Terms in Metrology*.

ISO/IEC Guide 43:1997. *Proficiency Testing by Interlaboratory Comparisons*. Part 1: Development and operation of proficiency testing schemes.

McBride GB. 2005. *Using Statistical Methods for Water Quality Management: Issues, options and solutions*. ISBN 0471733202 9780471733201; 344 pp. New York: Wiley.

Ministry of Health. *Public Health Risk Management Plan Guide PHRMP Ref: G2. General – Monitoring*. Available on: <http://www.health.govt.nz/water> then select publications and Water Safety Plans.

Ministry of Health. 2005. *Drinking-water Standards for New Zealand 2005*. Wellington: Ministry of Health. Revised 2008. <http://www.health.govt.nz/water>.

NHMRC. 2011. *Australian Drinking Water Guidelines 6*. 1244 pp. [www.nhmrc.gov.au](http://www.nhmrc.gov.au).

NIWA. 2007. *Equivalence Measures for Comparing the Performance of Alternative Methods for the Analysis of Water Quality Variables*. Report to the Ministry of Health. <http://www.health.govt.nz/publication/ministry-health-procedure-approval-new-test-methods-bacteriological-compliance-testing-drinking>; the calculator is also available.

Rienitz O, Schiel D, Guttler B, et al. 2007. A convenient and economic approach to achieve SI-traceable reference values to be used in drinking-water interlaboratory comparisons. *Accreditation and Quality Assurance* 12(12): 615–22. See abstract on <http://cat.inist.fr/?aModele=afficheN&cpsidt=19940494>.

Roberts G. 2007. Measurement uncertainty and its impact on regulatory standards. *Chemistry in Australia* 74(9): 24–6.

Royal Society of Chemistry. 2003. Is my uncertainty estimate realistic? *AMC Technical Brief* 15, December. UK: Analytical Method Committee. [http://www.rsc.org/images/realistic-estimate-technical-brief-15\\_tcm18-214874.pdf](http://www.rsc.org/images/realistic-estimate-technical-brief-15_tcm18-214874.pdf).

Royal Society of Chemistry. 2012. Dark uncertainty. *AMC Technical Brief* 53, July. UK: Analytical Method Committee. [http://www.rsc.org/images/brief\\_53\\_tcm18-221675.pdf](http://www.rsc.org/images/brief_53_tcm18-221675.pdf).

Sundaram B, Feitz A, Caritat P de, et al. 2009. *Groundwater Sampling and Analysis: A field guide*. Commonwealth of Australia, Geoscience Australia, Record 2009/27, 95 pp. [http://www.ga.gov.au/metadata-gateway/metadata/record/gcat\\_68901](http://www.ga.gov.au/metadata-gateway/metadata/record/gcat_68901).

Sinton L. 1986. A guide to groundwater sampling techniques. *Water and Soil Miscellaneous Publication* 99. National Water and Soil Conservation Authority.

USEPA. *Chain of Custody for Samples and Data* (an online course).  
<https://trainex.org/offeringlist.cfm?courseid=771>.

USEPA. 2002. *Standard Operating Procedure for Chain of Custody of Samples*. New England: Office of Environmental Measurement and Evaluation – Region 1. 11 Technology Drive, North Chelmsford, MA 01863. 10 pp. Available at:  
[http://www.epa.gov/region6/qa/qadevtools/mod5\\_sops/misc\\_docs/r1\\_chain-of-custody.pdf](http://www.epa.gov/region6/qa/qadevtools/mod5_sops/misc_docs/r1_chain-of-custody.pdf).

USEPA. 2003. *Long Term 2 Enhanced Surface Water Treatment Rule: Proposed Rule*. National Primary Drinking Water Regulations: 40 CFR Parts 141 and 142, August 11, 2003 – see USEPA (2006) for Final Rule.

USEPA. 2003. *IDEXX Colilert® - 18 Test Method for the Simultaneous Detection of Total Coliforms and E. coli in Water*. Draft. USEPA. 6 pp. Available at:  
[http://www.google.co.nz/search?hl=en&source=hp&q=%22IDEXX+Colilert%C2%AE-18+Test+Method+for+the+Simultaneous+Detection+of+Total+Coliforms+and+E.+coli+in+Water%22&btnG=Google+Search&meta=&aq=f&aqi=&aql=&oq=&gs\\_rfai=](http://www.google.co.nz/search?hl=en&source=hp&q=%22IDEXX+Colilert%C2%AE-18+Test+Method+for+the+Simultaneous+Detection+of+Total+Coliforms+and+E.+coli+in+Water%22&btnG=Google+Search&meta=&aq=f&aqi=&aql=&oq=&gs_rfai=).

USEPA. 2006. *National Primary Drinking Water Regulations: Long Term 2 Enhanced Surface Water Treatment Rule: Final Rule*. (LT2ESWTR). Federal Register Part II, 40 CFR Parts 9, 141 and 142. Washington: National Archives and Records Administration. See  
<http://www.epa.gov/fedrgstr/EPA-WATER/2006/January/Day-05/w04a.pdf>  
<http://www.epa.gov/fedrgstr/EPA-WATER/2006/January/Day-05/w04b.pdf>  
<http://www.epa.gov/fedrgstr/EPA-WATER/2006/January/Day-05/w04c.pdf>  
<http://www.epa.gov/lawsregs/rulesregs/sdwa/lt2/compliance.cfm>.

USEPA. 2003. *Chemical/Name Index to EPA Test Methods* (April). 85 pp. Available at:  
<http://www.google.co.nz/url?q=http://www.epa.gov/region1/info/testmethods/pdfs/testmeth.pdf&sa=U&ei=N-TyTMK3DpTksQPW8MnnCw&ved=0CBMQFjAA&usg=AFQjCNHKeIqQHKhmrPLHPwXCTeLXnJGhw>.

USEPA, USGS. National Environmental Methods Index. See <http://www.nemi.gov/>.

USEPA (regularly updated). *Analytical Methods Approved for Compliance Monitoring under the Enhanced Surface Water Treatment Rule*. 21 pp.  
[http://www.epa.gov/safewater/methods/pdfs/methods/methods\\_swtrules.pdf](http://www.epa.gov/safewater/methods/pdfs/methods/methods_swtrules.pdf).

Utah State. 2013. *Standard Operating Procedure for Chain-of-Custody Samples*. 18 pp.  
[http://www.deq.utah.gov/Compliance/monitoring/water/docs/2014/05May/SOP\\_COCPcedures\\_7.1.13\\_Rev0.pdf](http://www.deq.utah.gov/Compliance/monitoring/water/docs/2014/05May/SOP_COCPcedures_7.1.13_Rev0.pdf).

WHO. 2004. *Guidelines for Drinking-water Quality 2004* (3rd edition). Geneva: World Health Organization. Available at:  
[www.who.int/water\\_sanitation\\_health/dwq/gdwq3/en/print.html](http://www.who.int/water_sanitation_health/dwq/gdwq3/en/print.html) see also the addenda.

WHO. 2011. *Guidelines for Drinking-water Quality 2011* (4th edition). Geneva: World Health Organization. Available at:  
[http://www.who.int/water\\_sanitation\\_health/publications/2011/dwq\\_guidelines/en/index.html](http://www.who.int/water_sanitation_health/publications/2011/dwq_guidelines/en/index.html).

WHO. 2017. *Guidelines for Drinking-water Quality: Fourth edition incorporating the first Addendum*. Geneva: World Health Organization. 631 pp.

[http://www.who.int/water\\_sanitation\\_health/publications/drinking-water-quality-guidelines-4-including-1st-addendum/en/](http://www.who.int/water_sanitation_health/publications/drinking-water-quality-guidelines-4-including-1st-addendum/en/).

WHO. 2018. *Strengthening Operations and Maintenance through Water Safety Planning: A collection of case studies*. 20 pp. WHO/CED/PHE/WSH/18.69. WHO/IWA.

[http://www.who.int/water\\_sanitation\\_health/publications/strengthening-om-thru-water-safety-planning/en/](http://www.who.int/water_sanitation_health/publications/strengthening-om-thru-water-safety-planning/en/).

White ET. 1997. *Guidelines for Automated Water Quality Monitoring Equipment*. Ministry of Environ. Lands and Parks, Victoria, BC, Canada. See also *Automated Water Quality Monitoring* by same author, 1999, 73 pp. Available on website

[http://www.geoscientific.com/technical/tech\\_references\\_pdf\\_files/BC%20RISC%20Automatic%20Water%20Quality%20Monitoring%20Manual.pdf](http://www.geoscientific.com/technical/tech_references_pdf_files/BC%20RISC%20Automatic%20Water%20Quality%20Monitoring%20Manual.pdf).

# Chapter 18: Aesthetic considerations

## Contents

|        |  |    |
|--------|--|----|
| 18.1   | Introduction   | 1  |
| 18.2   | Aesthetic determinands   | 3  |
| 18.2.1 | Overview of aesthetic determinands                                     | 3  |
| 18.2.2 | Rationale for the aesthetic guideline values                           | 11 |
| 18.3   | Water treatment for the removal of aesthetic determinands              | 12 |
| 18.4   | Monitoring programme design  | 20 |
| 18.5   | Aesthetic guidelines criteria  | 21 |
| 18.6   | Analytical details   | 24 |
|        | References   | 28 |
|        | List of tables   |    |
|        | Table 18.1: Sampling frequencies for aesthetic guidelines (ex grading) | 23 |

## 18.1 Introduction

This chapter provides information on the sources and occurrences of the aesthetic determinands discussed briefly in the *Drinking-water Standards for New Zealand 2005, revised 2008* (DWSNZ). Determinands with a Guideline Value (GV) are listed in Table 2.5 of the DWSNZ.

This chapter explains the methods used to derive the Guideline Values for the aesthetic determinands and provides detailed information on how to apply the DWSNZ to these determinands. All the aesthetic determinands with a GV included in the DWSNZ have been derived from the WHO Guidelines.

Information is given on the planning and implementation of monitoring programmes, and how and why to carry out discretionary monitoring.

Information is provided for some treatment processes for the removal of some of the more common taste and odour problems.

Some aesthetic determinands also have a MAV; in most cases the MAV has a lower concentration than the Guideline Value.

The individual aesthetic determinands are described in detail in the Datasheets in Volume 3. Datasheets have also been prepared for determinands that have been reported in scientific literature to have an aesthetic effect in drinking water.

The term Guideline Value has been used for aesthetic determinands. Because they tend to be subjective, only Guideline Values (or ranges for some determinands) are given, rather than Maximum Acceptable Values (MAVs). Guideline Values for aesthetic determinands are mostly based on taste, odour, and appearance.

Corrosion of metallic pipes and fittings can give rise to aesthetically unpleasing water, eg, zinc from galvanised steel and brass, iron from galvanised piping and steel fittings, and copper from copper tubing. In some cases, corrosion can result in a determinand exceeding its MAV (eg, lead and copper), therefore corrosion is discussed in Chapter 10: Chemical Compliance.

The Institute of Environment and Health (IEH 2014) selected for consideration all those substances reported as being involved in taste and odour incidents in a developed country, excluding those for which there was no evidence of UK production or import, as well as those already regulated to a limit value either lower than or close to the reported taste and odour threshold. Other prioritised substances were then categorised according to amounts used and their reported taste and odour threshold. This process gave a list of compounds from which substances formed during water treatment were excluded leaving 18 priority compounds. Eleven of the prioritised taste and odour compounds were found to be fuel additives. Added to this list were the two compounds most commonly associated with taste and odour problems arising from natural sources (geosmin and 2-MIB). Most of the specified substances are discussed in the individual datasheets. The project was undertaken by addressing a series of distinct but inter-related objectives:

Objective 1: Establish a list of substances of interest that have low taste and odour thresholds and could pose a similar problem to water sources as EDD and EMD

Objective 2: Identify the quantities of substances used and the industries that use them; with respect to primary anthropogenic substances, this involves identifying in detail the quantities of substances used and the industries that use them in Europe and, to the extent possible, refining these estimates to England and Wales or UK specific information

Objective 3: Determine the possible routes of entry into the water system

Objective 4: Estimate the likely concentrations of substances of interest found in raw and treated drinking water



Objective 5: Produce a prioritised short list of substances based on the likelihood of exceeding taste and odour thresholds in treated drinking water in England and Wales that can be used to inform water company risk assessment, monitoring and management

Objective 6: Final report and dissemination of research findings.

A study in Adelaide found that people who indicated they usually drank mains water with or without a point-of-use filter or rainwater showed greater acceptance of metropolitan and regional (River Murray sources) tap water over all others. Commercial spring water was the third most accepted, with regional groundwater the least accepted. Those who usually drank bottled water indicated they had the greatest acceptance for commercial spring water. This suggests that individuals prefer the water they are most used to drinking (Webber et al 2014).

DWI (2014) describes a number of major taste and odour incidents in the UK and elsewhere involving contamination of drinking water by substances released into the environment due to anthropogenic activities, highlighted the need for awareness of potential threats to inform the development of effective risk management practices. These are discussed in individual datasheets.

## 18.2 Aesthetic determinands

### 18.2.1 Overview of aesthetic determinands

#### General remarks

Because the DWSNZ deal only with determinands that have a demonstrated significance for public health, no MAVs have been set for determinands whose undesirable effects are only aesthetic. Drinking-water that complies with the DWSNZ is deemed potable or safe; safe water that also satisfies the Guideline Values is deemed wholesome, see Health Act, 69G: Interpretation. In the UK water supplies provided for cooking, drinking, food preparation, washing and to premises where it is used for food production must meet the wholesomeness requirements of their Regulations regardless of whether the water is supplied from the public piped supply system, tanker, bottle or other container (DWI 2017).

It is recommended that drinking-water supplies should be maintained below the Guideline Values (GVs) given for the aesthetic determinands in Table 2.5 of the DWSNZ. Otherwise the water may be unattractive to consumers who could consequently change to a more attractive, but less safe, alternative.

Because of the link the mind makes between the aesthetic properties of a water and its safety, its appearance, taste and smell are very important to consumers. Most consumer complaints are received because of the aesthetic properties of water, not because trace levels of chemical contaminants have been noticed. A water will most closely meet consumer expectations when it is clear, colourless, odourless, cool and contains no unpleasant taste. This does not mean that a water should not contain any dissolved substances; a very high purity water has an insipid taste and is usually corrosive.

People are naturally wary of any drinking-water that smells, tastes, or looks cloudy or coloured. Although waters that are aesthetically unpleasant are not necessarily unsafe to drink, those characteristics of the water that are apparent to the senses are usually the only guide the public has to the microbiological quality of the water. Conversely, a clear, tasteless, odourless water is not guaranteed to be safe.

Awareness of the importance of minerals and other beneficial constituents in drinking-water has existed for thousands of years, being mentioned in the Vedas of ancient India. In the book Rig Veda, the properties of good drinking-water were described as follows:

Sheetham (cold to touch), Sushihī (clean), Sivam (should have nutritive value, requisite minerals and trace elements), Isthām (transparent), Vimalam lahu Shadgunam (its acid base balance should be within normal limits) (WHO 2005).

WHO (2005) also discusses some negative aspects of drinking deionised, distilled or reverse osmosis water, due to their tastelessness, and loss of essential minerals: mainly calcium and magnesium. This is discussed briefly in Chapter 10: Chemical Compliance, section 10.2.2, and in the respective datasheets.

In a UK survey 5 of the 17 responding Water Companies reported no issues associated with taste and odour. For the 12 companies reporting taste and odour problems, the majority were associated with biologically derived compounds (specifically geosmin and/or methylisoborneol) (7/12), or phenols (6/12) and chlorine (4/12). A number of other taste and odour compounds were identified less frequently (named in the report) (IEH 2014).

## Turbidity

The colour and turbidity of drinking-water affect its appearance. Turbidity also influences the safety of the water because particulate matter in the water can make the disinfection process less effective by shielding cells from the disinfectant. Turbidity may arise from clay and silt particles not removed from the raw water, or from the precipitation of insoluble metal compounds such as those of iron and manganese, or aluminium from an inefficient treatment plant using alum or PAC coagulation. Sometimes the iron and manganese can be associated with micro-organisms such as the loosely defined group of iron bacteria; this is usually more common in groundwater systems (see Chapter 3: Source Waters, section 3.2.3.4). Turbidity can also be introduced into the water from the scouring effect in the mains, or from sediments flushing out of service reservoirs.

A common consumer complaint of turbid water can occur after maintenance work on nearby water mains or general pressure problems that causes very fine air bubbles to give the water a milky appearance. This condition can be confirmed by filling a glass and watching the water clear slowly, beginning from the bottom of the glass.

## Colour

It is necessary to distinguish between true colour and apparent colour.

True colour arises predominantly from dissolved natural organic matter, mainly humic material (fulvic acids tend to be colourless) formed as a result of the degradation of vegetation. It is the colour the eye would see if there were no turbidity in the water.

If the water is turbid, it affects the colour as seen by the eye, which perceives a different colour, called the apparent colour. When colour is measured routinely in the laboratory it is usually the apparent colour. When measuring apparent colour the analyst attempts to match the colour on the Hazen disc with the colour of the water, including the particulate matter. When the turbidity is high, this colour match can be very difficult and quite misleading. Many people reading colour in a turbid sample report more colour than they should.

A true colour value can be obtained by removal of turbidity before making the colour measurement. Filtration through a 0.45 µm membrane filter or through a Whatman GF/C (or equivalent) filter may provide an acceptable means of doing this, but checks need to be made that the filter material is not also removing true colour from the water, or adding to it. Due to the fairly subjective nature of colour measurement, sometimes there is an advantage in measuring UV absorption at 254 nm; this is a much more reliable test.

Because of the nature of the material that usually gives rise to colour, the presence of colour may affect the taste of the water as well as its appearance.

Standard Methods (APHA 2005, method 2120 B) states that 1 colour unit (CU) = 1 Hazen unit = 1 Pt/Co unit. When reporting colour readings, it is important to state whether apparent or true colour was measured. True and apparent colour is usually indistinguishable in drinking-water samples that are free from corrosion products or that have low turbidity.

The Australian Water Quality Guidelines describe the public's perception of colour:

A true colour of 15 Hazen can be detected in a glass of water, and a true colour of 5 Hazen can be seen in larger volumes of water, for instance in a white bath. Few people can detect a true colour level of 3 Hazen, and a true colour of up to 25 Hazen would probably be accepted by most people provided the turbidity was low.

Also, see datasheets for colour and UV absorbance (or UVT).

## Temperature

A number of other factors may affect the taste of the water. The most universal of these is temperature. The taste of a water is generally more acceptable when it is cool rather than when it is warm. Generally consumers become increasingly aware of taste as the water warms. Most odorous compounds are volatile so they will become more noticeable as the water warms.

Water can become noticeably warm if drawn from mains or service pipes that are on or near the surface, or from above-ground service reservoirs or tanks. Warm water in the distribution system also encourages the growth of micro-organisms, and accelerates the decomposition of free available chlorine (FAC); therefore pipes need to be buried. Pipes may need to be at least a metre deep in very cold areas to avoid problems related to freezing.

The temperature of surface waters in New Zealand can range quite widely, generally:

- in the summer, as high as 16–25°C in the north, 10–25°C in the south
- in the winter, as low as 8–12°C in the north, 5–10°C in the south.

The temperature of groundwater drawn from near the surface can vary seasonally, but deeper groundwater has a near-constant temperature that is usually close to the mean annual air temperature. Waters drawn from depths greater than about 50 m increase in temperature at about 0.6°C per 30 m increase in depth due to geothermal heat. Any groundwater with a higher than expected temperature may contain water from a hydrothermal source, possibly leading to elevated levels of boron and other geothermal contaminants, such as arsenic, mercury, fluoride, boron and lithium. Bore waters that exhibit a seasonal temperature pattern are not likely to be secure.

Water from unburied service reservoirs with a long detention time can reach 30°C in the summer. Inadequately buried dark coloured service pipes to houses can produce water that is almost too hot to drink!

Water temperatures, particularly of surface waters, can also have an indirect effect on the aesthetic quality of the water by stimulating algal blooms. The seasonal appearance of algae in rivers, lakes or reservoirs can cause tastes due to the exudates released by the organisms.

The WHO (2005) recommends maintaining the water temperature below 20°C to reduce the risk of legionellosis. *Legionella* organisms have been reported growing in hot water systems up to about 60°C. Temperature control of hot water cylinders as required by the New Zealand Building Act/Building Code should control the organism in buildings. See datasheet.

## pH

High pH waters (alkaline) have an unpleasant taste, and the high pH can also impart a soapy feel to the water. Low pH levels may influence the taste of the water indirectly by the release of metal corrosion products. Metallic tastes, whether from corrosion products or natural concentrations of metals, iron for example, can be unpleasant. The pH of slow moving water can exceed 10 in some supplies in pipes with concrete linings or made with cementitious material. The same is true of rainwaters stored in concrete tanks. The effect lessens with time as  $\text{Ca}(\text{OH})_2$  (lime) is leached from the surface of the concrete, or if organic matter in the water coats the surface, although this may take years. Fish placed in high pH water can be affected adversely.

Risk management issues related to pH are discussed in the MoH Public Health Risk Management Plan Guide PHRMP Ref: P8.1: Treatment Processes – pH Adjustment.

## Inorganic compounds

Inorganic compounds in high concentrations, such as sodium chloride (salt) or sodium bicarbonate (soda springs may contain high concentrations) which lead to high levels of total dissolved solids, can also influence the taste of water. Very high concentrations of sulphate can cause a laxative effect in unaccustomed consumers, especially when magnesium concentrations in the water are also high.

Water constituents such as calcium carbonate or silica can lead to scale formation or reduce soap lathering, and may also introduce particulate matter into the water, reduce flows through pipes, and lead to the premature burnout of heating elements.

A high chloride and sulphate content (compared with alkalinity) can increase corrosion rates. Corroding fittings can impart a metallic taste to water. Hard or mineralised waters usually require special treatment if used in boilers. However, some people find the high mineral content of some bottled waters to be attractive.

See WHO (2005) and Chapter 10: Chemical Compliance, section 10.2.2 for a discussion on some possible health aspects related to drinking water with low levels of inorganic determinands, particularly calcium and magnesium.

## Organic compounds

A wide range of organic substances may influence taste and odour. These include organic compounds that are natural in origin, synthetic compounds, chemicals used in industry that have found their way into the source water, tastes and odours that are derived from organisms living in the raw water or stored treated water, and organic compounds formed as a consequence of reactions between natural (or other) organic matter and disinfectants during treatment.

The AWWA (USA) states that earthy musty odours may usually be attributed to the source water, and their intensity may increase with warmer weather. Customer complaints about this type of odour are second in number only to disinfection-related complaints. The most common source for these odours is geosmin (produced by *Actinomyces*, *Streptomyces*, *Nocardia*, *Micromonospora*, *Microbispora*, *Oscillatoria*, *Apahizomenon*, and *Phormidium* bacteria); and 2-methylisoborneol (MIB), produced by *Actinomyces*, *Oscillatoria*, *Phormidium*, *Uroglena americana* and blue-green algae (cyanobacteria). Fishy odours may come from algal products (including n-hexanal, n-heptanal, trimethylamine and trans, trans-2,4-decadienal). Related odours are described as swampy (from bacteria producing dimethyl trisulfide or aldehydes), grassy (from algal production of cis-3-hexen-1-ol), musty (from MIB or 2,4,6-trichloroanisole), or tobacco-like (from production of  $\beta$ -cyclocitral).

Davies et al (2004) report their studies of some odours resulting from lakes and reservoirs in Canada; they list some odour thresholds. Earthy odours were more prevalent in reservoirs and lakes with higher total phosphorus (TP), whereas decomposing vegetation and green vegetation + grassy odours almost exclusively occurred when TP was lower (<0.013 mg P/L).

A preliminary study by Webber et al in Australia indicated that drinking water containing greater than 10 ng/L geosmin or 2-MIB will result in a reduction in acceptance.

Cis-3-hexen-1-ol, which has been found to contribute a grassy odour to water, is thought to arise from green algae (EA 1998, 2004). This chemical is approved as a flavouring agent so presents no health concerns in water. The chemical (CAS No. 928-96-1) is also called (Z)-hex-3-enol and 'green leaf alcohol'. See individual datasheets for further details.

Refer also to colour, in this chapter. Some organic chemicals also leach from plumbing materials, see Chapter 16.2.6: Permeation and leaching.

Risk management issues related to the removal of organic compounds are discussed in the MoH Public Health Risk Management Plan Guide PHRMP Ref: P8.4: Treatment Processes – Trace Organics Removal.

WQRA (2010) reports that a survey of 37 drinking water providers in Australia, representing 5 million customers, found that 78% of the providers had experienced problems with earthy/musty odours and half had not positively identified the problem compounds and were not carrying out routine chemical analysis. Interestingly, only five respondents reported a definite link between algal numbers and T&Os, indicating a need for further investigation. Their study found that loss processes such as biodegradation and volatilisation have a major effect upon the concentration of T&Os in a reservoir. Biodegradation was found to be temperature dependent with optimum rates occurring at 20–25°C. Biodegradation followed a first-order reaction rate and based upon this the half-life of geosmin was approximately 1 day at 20°C. This means that it would take approximately 24 hours for geosmin to reach 50% of its original concentration through biodegradation alone. Volatilisation was also found to be a significant loss factor with the rate directly related to wind speed, whereas photodegradation is not likely to be an important loss mechanism in natural water. The project incorporated all of these processes into a conceptual and mass balance model.

## Hydrogen sulphide

Hydrogen sulphide can be smelt in some groundwaters (anoxic, and usually deep), often at concentrations below the analytical detection limit of commonly used tests.

## Chlorine

Most individuals are able to taste or smell chlorine in drinking-water at concentrations well below the MAV of 5 mg/L. Many people can detect the odour of chlorine at around 0.2 mg/L and the taste at around 0.4 mg/L, particularly if there are any off-flavours due to chlorine reacting with organic matter. At a free available chlorine (FAC) concentration of between 0.6 and 1.0 mg/L, there is an increasing likelihood that some consumers may object to the taste or odour of FAC. However, some people occasionally complain when they cannot smell chlorine in their drinking-water because they think it has not been disinfected adequately.

A preliminary study by Webber et al in Australia indicated that chlorine taste and odour acceptance decreased above 1 mg/L but retained a volunteer rating of 'acceptable' for all samples in the range tested (maximum 3 mg/L). A statistically significant decrease in acceptance was found between 0 mg/L and 1 mg/L however drinking water at 0 mg/L is unusual as residual chlorine is required throughout the distribution systems.

## Chloramines

Monochloramine is not objectionable at concentrations as high as 5 mg/L. It can cause taste and odour problems when in conjunction with FAC, and with some organic substances in the water or associated with plumbing materials. Dichloramine and trichloramine should not occur in drinking-water; both can cause taste and odour complaints. For further discussion, refer to Chapter 15: Treatment Processes, Disinfection, section 15.5.2.

## Other tastes and odours

The topic of tastes and odours is rather subjective. What constitutes a taste or odour in drinking-water varies widely amongst people. It can also vary for the individual, depending on mood, motivation, expectation, familiarity and the level of confidence they have with their water supply or supplier.

Some reported tastes are actually odours; if a glass of water is raised to the mouth while the drinker is not breathing in, the sensation may not be noticed until the water is in the mouth.

Drinking-waters produced by distillation, deionisation or reverse osmosis are often described as tasting flat, or being tasteless.

Theoretically, taste refers only to the sensations of bitter, sweet, salty and sour. However, when attempting to describe the taste of water, people actually record flavour, which is an overall effect. Some complaints are difficult to describe other than by saying the water has an unpleasant drying sensation on the tongue and palate, often after swallowing. Standard Methods (APHA 2005) has a section on taste and odour test panels: Methods 2150, 2160 and 2170.

## Wildlife

The public usually does not like to see wildlife in their drinking-water. Small numbers of invertebrates may pass through the water treatment process where the barriers to particulate matter are not completely effective and then colonise the distribution system. Their motility (ability to move) may enable them and their larvae to penetrate filters at the treatment plant, and through vents on storage reservoirs. The commonest examples in New Zealand are probably midge and mosquito larvae, nematodes and visible colonial algae such as *Volvox*. Slow sand filters have been reported to produce more organisms than the more traditional treatment processes used in New Zealand. Wildlife can also enter the system through service reservoirs, mains laying and repair, and in roof tanks.

## Other comments

Determinands affecting the aesthetic quality of the water can also be linked to other problems related to the use of the water in the home or industry. Some of these problems may have an economic impact. The possibility of corrosion leading to concentrations of metals high enough to cause tastes has been noted above, but the dissolution of pipework, plumbing fittings and hot water cylinders also has economic implications for consumers; a common cause is due to carbon dioxide in groundwater.

Water quality complaints/comments from consumers should be followed up because they often assist in solving other problems, eg, petrol spills. Following up a complaint of a sulphide smell in a surface water public water supply led to the discovery that the house was not even on the town supply, but fed from a bore!

The range over which the concentration of a particular determinand is acceptable may vary from individual to individual, and community to community, and may depend on the concentration of other determinands in the water. The determinands with Guideline Values listed in the DWSNZ are a guide to what may be acceptable to consumers over an extended period. However, problems may occur at higher or lower values according to local circumstances. Consumer complaints may arise from determinands without a GV. Consultation with the community offers a mechanism by which the balance between water quality and cost to the community can be determined.



## 18.2.2 Rationale for the aesthetic guideline values

While most aesthetic determinands in drinking-water do not have a direct influence on public health at or near their GV, they are largely responsible for determining whether people will drink the water. This decision is usually based on smell, taste and appearance.

The Guideline Values (GVs) for aesthetic determinands given in the DWSNZ are largely based on the World Health Organization (WHO) document *Guidelines for Drinking-water Quality, 2004* and subsequent editions. The WHO GV's were developed to be acceptable internationally. New Zealand being a developed country, it was appropriate to adopt some slightly lower GV's than appear in WHO (2004). These Guideline Values should ensure that drinking-water is aesthetically pleasing and will not cause corrosion or physical problems in the reticulation or domestic plumbing.

The GV's are not absolute values, but have been derived from the consideration of a number of factors. Exceeding the aesthetic GV's for a short period will not necessarily render the water unacceptable. Feedback from the public should provide guidance as to what the customers consider to be acceptable. However, unless the public has already experienced unsatisfactory water, their opinion may not be sufficiently reliable to use as guidance when planning a new scheme or modifications.

Water supply authorities should maintain a register of complaints and enquiries relating to water quality (refer to Chapter 2: Management of Community Supplies and Chapter 16: The Distribution System). Preferably this will involve establishing a team that has been trained in handling consumer complaints. Procedures should be formalised in the WSP or other appropriate documentation. A standard questionnaire provides a consistent approach when interviewing complainants.

Further details on the levels of aesthetic determinands acceptable in water supplies are given in the individual Datasheets in Volume 3. The factors considered when deriving the Guideline Values include:

- taste and odour thresholds, ie, the smallest concentration or amount that would be just detected by smell or taste
- the smallest concentration or amount that would just be visible in a glass of water
- the smallest concentration or amount that would produce noticeable stains on laundry or porcelain
- the minimisation of corrosion or encrustation of pipes or fittings.

Several determinands without an aesthetic GV have been reported to give rise to consumer complaints. Datasheets have been prepared for some of these.

## 18.3 Water treatment for the removal of aesthetic determinands

Point-of-entry (POE) and point-of-use (POU) systems designed for the removal of aesthetic determinands are covered, for example, by NSF/ANSI 42-2005e. Determinands included are chloramines, chlorine, hydrogen sulphide, iron, manganese, zinc, particulates, and pH adjustment. NSF/ANSI 58-2006 *Reverse Osmosis Drinking Water Treatment Systems* is designated as an ANSI standard for point-of-use units. Tastes and odours can also be addressed by using these systems. POE and POU systems are discussed further in Chapter 19.

### Ammonia

A groundwater with say >2 mg/L ammonia at a pH of say 9 may result in enough ammonia gas to be expelled when running the tap for some people to notice:

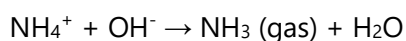

Ammonia can be removed by breakpoint chlorination, refer to Chapter 15: Treatment Processes, Disinfection, section 15.5.1. This avoids the formation of chloramines, but requires a high dose, theoretically 7.6 parts of chlorine per part of ammonia. The ratio may vary depending on the pH and temperature of the water, and even the mixing efficiency. The process can be rather expensive once the ammonia concentration exceeds say 0.5 mg/L.

Chlorine dioxide does not react with ammonia.

### Carbon dioxide (CO<sub>2</sub>)

Carbon dioxide is usually removed from groundwater (usually non-secure bores) to reduce or eliminate corrosion of metallic pipes, pumps and fittings, and dissolution of concrete.

It is removed by aeration, or by chemical reaction with calcium hydroxide (hydrated lime) or sodium hydroxide (caustic soda).

Removal of carbon dioxide is discussed in Chapter 12: Treatment Processes, Pretreatment, section 12.2.1.

## Chlorine

If there are general taste and odour problems at a chlorine concentration less than approximately 0.5 mg/L, they may be a result of interactions between chlorine and nitrogenous substances, or traces of phenolic substances naturally occurring in the water. Surface waters containing ammonia often also contain traces of amino acids and other nitrogenous compounds that may react with FAC to cause chlorinous tastes and odours at quite low levels of measured FAC. When serious taste and odour problems develop, activated carbon dosage may be needed to remove these at the treatment plant prior to chlorination.

Chlorination of water containing ammonia (usually bore water) can produce chloramines; dichloramine and trichloramine theoretically can be produced if the pH is very low (under 6). Although the pH of the water supply may be above 7, a high chlorine dose into a lightly buffered water may lower the pH to under 6 in localised areas, especially if mixing is poor. Improved mixing, breakpoint chlorination, or simply a higher dose, may overcome these problems. In the absence of any complications such as FAC or dichloramines also being present, monochloramine should not impart a noticeable taste or odour at concentrations normally found in the distribution system (say 0.4–2.0 mg/L). The greatest problems with chloramine formation from ammonia are likely to occur at low pH and high chlorine concentrations, but not high enough to achieve destruction of the chloramines. These situations favour the formation of the more highly chlorinated and more odorous chloramines, dichloramine and trichloramine.

Some taste or odour problems can arise if the chlorine dosing system allows areas of low chlorine concentration to occur, where there may not be instantaneous reaction with organic matter, ie, breakpoint chlorination does not occur, allowing intermediate products to exist in the water.

Localised problems can result from an interaction of FAC with coatings or additives used in or on concrete or plastic piping, etc. Some particularly nasty tastes have been experienced when the water has been in contact with a fire hose. Rubber and plastic hoses used to fill drinking water tanks on ships, coaches, caravans, trains, etc may give rise to taste and/or odour problems, as can hoses used to fill drink-vending machines (EA 1998). All materials used in the water supply should be suitable for use in drinking-water. A simple test routine was explained by Ogilvie (1986). See AS/NZS 4020 (2002) for some information about the testing of products for use in contact with drinking-water. Micro-organisms in the biofilm (slime) on pipe surfaces can also interact with FAC, sometimes causing tastes or odours.

Occasionally some individuals (and aquarium fish) appear to have a very strong objection to chlorine in the water (or whisky!) they are drinking or swimming in. Water that has been in sunlight for some time (several hours) will usually show a large drop in the FAC level. Boiling the water will also reduce the chlorine concentration, and water from the hot tap usually contains very little chlorine. Chlorine can also be removed using point-of-use activated carbon filters; however, these can grow large numbers of micro-organisms so the supplier's instructions must be followed; see Chapter 19: Small, Individual and Roof Water Supplies, note 1 to Table 19.2 in section 19.2.4.

Further information on chlorination and chloramination appears in Chapter 15: Treatment Processes, Disinfection, section 15.5.

## Colour and turbidity

Generally, colour due to natural organic matter (predominantly humic, and to a lesser extent, fulvic material) is removed by chemical coagulation. Chemical oxidation by chlorine, chlorine dioxide or ozone can also reduce colour, but the extent to which this is achieved depends on the oxidant, the nature of the organic matter, and the treatment conditions. An undesirable consequence of reducing colour in this way may be the formation of disinfection by-products.

Turbidity is removed by chemical coagulation followed by sand filtration, or by direct filtration techniques such as diatomaceous earth, cartridge filters or membrane filtration.

These treatment processes are described in Chapters 13: Coagulation with Filtration, Chapter 14: Filtration, and Chapter 15: Disinfection.

## Hardness (calcium and perhaps magnesium)

Calcium and magnesium are the main components of water hardness. Hard water can cause calcium carbonate to deposit in pipes, hot water cylinders, boilers, and over kettle elements. In the extreme, it can be tasted. Hard water requires a lot more soap to be used to develop a lather. Surface waters in New Zealand are generally soft because the water has not been in contact with minerals long enough to dissolve large quantities of calcium or magnesium. Groundwaters, on the other hand, that have been in contact with calcium carbonate-containing rocks, such as limestone and marble, are likely to be hard to some degree.

New Zealand's waters are generally softer than those found overseas. More than 90 percent of water supply zones in New Zealand receive water that, according to the hardness scale used by the American Water Works Association, is classified as soft (hardness 0–75 mg/L as CaCO<sub>3</sub>). As at 2005, no town water supplies in New Zealand are softened regularly.

Calcium is usually the main contributor to hardness, so is usually the substance targeted in the water softening process. Softening can be carried out by ion exchange or the lime process.

Ion exchange (WHO 2004) is a process in which ions of like charge are exchanged between the water phase and the solid resin phase. Water softening can be achieved by cation exchange. Water is passed through a bed of cationic resin, and the calcium ions and magnesium ions in the water are replaced by sodium ions. When the ion exchange resin is exhausted (ie, the sodium ions are depleted), it is regenerated using a solution of sodium chloride.

The process of dealkalisation can also soften water. Water is passed through a bed of weakly acidic resin, and the calcium and magnesium ions are replaced by hydrogen ions. The hydrogen ions react with the carbonate and bicarbonate ions to produce carbon dioxide. The hardness of the water is thus reduced without any increase in sodium levels.

Some care is needed in the use softening by ion exchange, as the very efficient stripping of calcium and magnesium from the water can result in water that is more corrosive than it was before treatment.

An ion exchange plant normally consists of two or more resin beds contained in pressure shells with appropriate pumps, pipework and ancillary equipment for regeneration. The pressure shells are typically up to 4 m in diameter, containing 0.6–1.5 m depth of resin.

Risk management issues related to softening are discussed in the MoH Public Health Risk Management Plan Guide PHRMP Ref: P8.3 Treatment Processes – Softening.

Traditional water softening and softening by ion exchange are discussed a little more fully in Chapter 13: Coagulation Processes, section 13.6. NSF/ANSI 44-2004 *Residential Cation Exchange Water Softeners* is designated as an ANSI standard.

## Hydrogen sulphide (H<sub>2</sub>S)

H<sub>2</sub>S can be found in otherwise quite good quality groundwater. It is formed when soil bacteria reduce sulphate ions in the water percolating through the soil. Groundwater containing H<sub>2</sub>S would usually be expected to be anaerobic.

The Guideline Value is 0.05 mg/L in water but some people can smell it at as low as about 0.1 µg/L (0.0001 mg/L). It is readily displaced into the air where it can be detected at as low as 0.8 µg/m<sup>3</sup>.

If the groundwater is aerated the H<sub>2</sub>S is usually dispelled quite rapidly (unless the pH is high, say above pH 8), but after aeration the water may require repumping.

To avoid the costs of repumping the H<sub>2</sub>S can be oxidised using a low dose of chlorine, with the dose being used for disinfection usually being adequate. Chlorine should only be used if the H<sub>2</sub>S concentration is low, otherwise the production of elemental sulphur or polysulphides may noticeably increase the turbidity. The amount of chlorine needed depends on various factors such as pH and temperature, (and probably most importantly) on the accuracy of the sample collection and H<sub>2</sub>S testing procedure (which is very difficult). Generally it is best to find the required chlorine dose by trial and error. Two of the more commonly proposed reactions (which are rapid) are:

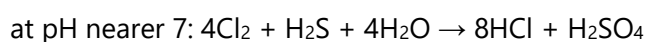

Surface water supplies should not produce H<sub>2</sub>S complaints, so if H<sub>2</sub>S is found at a consumer's tap, there must be a serious problem in the distribution system or consumer's plumbing.

## Iron

Iron can stain porcelain and clothing. It also builds up on the inside of water mains where it can shield micro-organisms from residual disinfectants. It can build up forming slimes and encrustations that can break off during flow reversal or velocity changes, causing widespread complaints of dirty water.

Iron is usually only a problem in groundwater and spring supplies, unless it is dissolved from iron pipes, such as cast iron or galvanised iron after the galvanising has been removed, by corrosive water. Some groundwaters containing iron can appear to be clear when leaving the bore, but after aeration, it can change to an orange/brown colour due to oxidation of soluble ferrous iron (II) to insoluble ferric iron (III).

Iron also can occur in lakes and reservoirs, particularly during summer and autumn when the water body stratifies and the bottom waters (in the hypolimnion) become anaerobic, in which conditions iron is reduced to the soluble ferrous form. The iron content in the bottom water can exceed 10 mg/L Fe. The problem can be reduced by artificial aeration, or by abstracting through a valve at a higher depth where the iron concentration is manageable. Reservoir and lake waters that produce high concentrations of iron usually undergo chemical coagulation, which is described in Chapter 13: Treatment Processes, Coagulation. Provided the raw water receives sufficient aeration so that the ferrous form is oxidised to ferric, coagulation is usually effective at removing the iron.

Risk management issues related to reservoir destratification are discussed in the MoH Public Health Risk Management Plan Guide PHRMP Ref: P4.2 Pre-treatment Processes – Destratification.

Groundwater does not usually require colour or turbidity removal, as long as the bore has been well developed, so if iron is greater than about 0.2 mg/L as Fe (the Guideline Value), it will require some other form of treatment. The first step is to ensure that the raw water is fully aerated. Sometimes that is enough; the iron content can be so high that, when oxidised, it forms a floc that settles in a clarifier and the small amount remaining is removed by filtration, see Chapter 12: Treatment Processes, Pretreatment, section 12.2.

In some waters the iron is more difficult to remove, often because it forms complexes with natural organic matter that are less easily oxidised. For satisfactory oxidation, these waters may require pH elevation, sometimes to higher than pH 9, depending on the nature of organic matter. After filtration this water will probably need pH correction.

An alternative is to oxidise the ferrous iron with chlorine, chlorine dioxide, ozone or potassium permanganate. The efficacy of chlorine and chlorine dioxide treatment increases with pH. Ozone is more efficacious than the other oxidants when dealing with complexed iron (see further discussion below). Care is needed with potassium permanganate to avoid overdosing, which will cause complaints about the aesthetic properties of the water.

The presence of manganese on the surface of filter medium particles acts as a catalyst for the oxidation of iron. Such a coating can result from the oxidation of naturally occurring manganese in the water, the use of potassium permanganate, or the use of greensand filters.

## Manganese

The source of manganese and its treatment options are similar to iron (see above) but it is usually more difficult to deal with, and causes aesthetic problems at lower concentrations. Concentrations of manganese as low as 0.04 mg/L Mn in water in the distribution system can cause periodic staining or discoloration problems, particularly after disturbances in the distribution system. Concrete-lined mains and fibrolite pipes have a high pH at the water/pipe surface interface, so even water with a low manganese content can deposit manganese on the surface.

Soluble manganous manganese (valence 2) frequently exceeds 1 mg/L as Mn in the bottom waters of lakes and reservoirs (hypolimnetic water), which is higher than the MAV (0.4 mg/L). See Chapter 13: Treatment Processes, Coagulation for a discussion on chemical coagulation.

Generally it will need aeration together with chemical oxidation and pH elevation, followed by filtration, in order to achieve satisfactory removal. If the chlorine dose required is too high (ie, requires some subsequent dechlorination) chlorine dioxide, potassium permanganate or ozone may be viable alternatives for oxidising the manganese to the insoluble manganic (valence 4) form. Some stubborn waters may require catalytic filter sand (see the comment regarding the catalytic action of manganese in the section on iron).

The oxidation rate of manganese (II) can be rather slow, so secondary filtration may be useful (and preferable to it precipitating in the distribution system), see Chapter 13, section 13.8.

## Iron and manganese removal using ozone

Ozone will oxidise iron and manganese, converting the soluble ferrous iron (Fe<sup>II</sup>) to the insoluble ferric iron (Fe<sup>III</sup>), and Mn<sup>II</sup> to Mn<sup>IV</sup>.

The dose of ozone required to oxidise 1 mg iron is 0.43 mg. Adding excess ozone has no effect on the oxidation of iron.

There are two possible oxidation reactions for manganese:

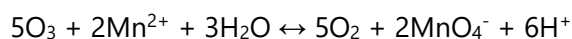
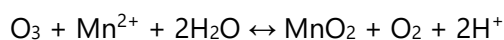

The required ozone dose for oxidation to the insoluble Mn<sup>IV</sup> is 0.88 mg for 1 mg manganese.

The required ozone dose for oxidation to the soluble Mn<sup>VII</sup> is 2.18 mg for 1 mg manganese.

The production of Mn<sup>IV</sup> or Mn<sup>VII</sup> will depend on the ratio of ozone to manganese employed. If Mn<sup>VII</sup> is produced, it will have to be reduced to Mn<sup>IV</sup> prior to removal by filtration. This can be achieved by filtering through granular activated carbon filters.

The pH for iron removal using ozone is in the range 6–9; however manganese removal is best achieved at a pH of around 8. Consideration should be given for control of the pH upstream and downstream of the filters, as it is possible to dissolve precipitated and filtered manganese, should the pH be allowed to drop.

Risk management issues related to iron and manganese removal are discussed in the MoH Public Health Risk Management Plan Guide PHRMP Ref: P8.2: Treatment Processes – Iron and Manganese Removal.

## Tastes and odours (except hydrogen sulphide)

Other than sulphide, the cause of taste and odour problems is not usually identified in terms of specific determinands. In New Zealand, most sporadic or seasonal taste and odour events are related to biological activity in the river, lake or reservoir source water.

Many chemicals have been identified as the cause of tastes and odours. Those with a biological origin are usually difficult and/or expensive to analyse, and their threshold concentrations are not well documented. They include geosmin (trans-dimethyl-trans-9-decalol), 2-methyl isoborneol (MIB), 2-isopropyl-3-methoxypyrazine (similar to MIB), 2-isobutyl-3-methoxypyrazine, cadin-4-ene-1-ol and 2,3,6-trichloroanisole; these have been reported to arise from bacteria in the actinomycete group; AWWA (2004) and EA (1998 and 2004) discuss biology, ecology, identification and control strategies.

The commoner chemicals that cause tastes and odours, usually with an industrial origin, are included in Table 2.5 of the DWSNZ. Their Guideline Values are based on the WHO Guidelines, and are discussed in the Datasheets.

EA (1998) has copied an excellent *Taste and Odour Wheel* from an American Water Works Association Research Foundation report by Suffet et al (1995), titled *Advances in Taste and Odour Treatment and Control*.

The commonest and most reliable form of treatment is to dose with activated carbon. The process is quite expensive so for temporary dosage, powdered activated carbon (PAC) is preferred. The type of PAC and its dose can only be found by trial and error.

It is used in response to sniffing the raw water or to the public reacting to unpleasant tastes or odours. Some people have a poor sense of smell so those conducting sniff tests should be screened. Many chemicals that contribute to odour in water are volatile and are therefore more pronounced in warm water. Often, the public will be more aware of the odour when in the shower than when drinking the water. A useful device for identifying when the raw water is smelly is to atomise it at 35–40°C into a large glass jar or bottle, with the tester sniffing the bottle opening.



Water supplies that draw from more polluted sources, or water that contains cyanotoxins, may require more regular activated carbon treatment in order to comply with the chemical or cyanobacterial MAVs in the DWSNZ. Because these waters usually also require full chemical treatment, this is discussed in Chapter 13: Treatment Processes, Coagulation.

WHO (2004) states that activated carbon is produced by the controlled thermalisation of carbonaceous material, normally wood, coal, coconut shells or peat. This activation produces a porous material with a large surface area (500–1500 m<sup>2</sup>/g) and a high affinity for organic compounds. It is used either in powdered (PAC) or in granular (GAC) form. When the adsorption capacity of the carbon is exhausted, it can be reactivated by burning off the organics in a controlled manner. However, PAC (and some GAC) is normally used only once before disposal. Different types of activated carbon have different affinities for different types of contaminants.

PAC is dosed as a slurry into the water and is removed by subsequent treatment processes together with the waterworks sludge. Its use is therefore restricted to surface water treatment works with existing filters. The choice between PAC and GAC will depend upon the frequency and dose required. PAC would generally be preferred in the case of seasonal or intermittent contamination or where low dosage rates are required. Because prompt delivery of PAC usually cannot be guaranteed, procedures for obtaining PAC at short notice need to be specified in the WSP for those water supplies prone to taste and odour problems.

GAC in fixed-bed adsorbers is used much more efficiently than PAC dosed into the water, and the effective carbon use per water volume treated would be much lower than the dose of PAC required to achieve the same degree of removal.

GAC is normally used in fixed beds, either in purpose-built adsorbers or in existing filter shells by replacement of sand with GAC of a similar particle size. Although at most treatment works it would be cheaper to convert existing filters rather than build separate adsorbers, use of existing filters usually allows only short contact times. It is therefore common practice to install additional GAC adsorbers (in some cases preceded by ozonation) between the rapid gravity filters and final disinfection.

The service life of a GAC bed is dependent on the quality of the feed water, the capacity of the carbon used, the contact time between the water and the carbon, the empty bed contact time (EBCT), controlled by the flow rate of the water. EBCTs are usually in the range 5–30 minutes. GACs vary considerably in their capacity for specific organic compounds, which can have a considerable effect upon their service life. A guide to capacity can be obtained from published isotherm data. Carbon capacity is strongly dependent on the water source and is greatly reduced by the presence of background organic compounds. The properties of a chemical that influence its adsorption on to activated carbon include the water solubility and octanol/water partition coefficient ( $\log K_{ow}$ ). As a general rule, chemicals with low solubility and high  $\log K_{ow}$  are adsorbed well.

The use of activated carbon is also discussed in Chapter 14: Treatment Processes, Filtration and Adsorption, section 14.7. Point-of-use/point-of-entry treatment systems are discussed in Chapter 19: Small, Individual and Roof Water Supplies, section 19.3.4.

USEPA (2004) is the Environmental Technology Verification (ETV) Technology Specific Test Plan for evaluation of drinking water treatment equipment utilising fixed bed adsorptive media and aeration plant for volatile organic chemical (VOC) removal.

WRF (2014) reports the results of aeration trials on the removal of several volatile organic contaminants from water. The VOCs' removal efficiencies were studied by collecting operational data from pilot plant operations, under various air-to-water ratios (53–652), three different temperatures (4, 12, and 20°C), and 1 to 6 trays in series.

## 18.4 Monitoring programme design

Monitoring of some aesthetic determinands is carried out as part of the routine process control of the water treatment process or operation of the distribution system, or to investigate consumer complaints and any subsequent troubleshooting. Process control is discussed in Chapter 17: Monitoring Water Treatment and Drinking-water, section 17.3, and section 17.2 discusses sampling.

Some aesthetic determinands may only reach nuisance level after climatic events such as drought (taste and odour due to low river flows, or changes in the composition of shallow groundwater), or flood (more colour in surface water or more turbidity in shallow groundwater), while others may be seasonal (algal-related taste and odour). A certain amount of routine monitoring may be needed before these relationships are understood. A water supplier needs to know the normal concentration range of aesthetic determinands before they can identify what may have initiated a complaint. Ideally (but rarely), these source water conditions should be understood before a water treatment plant is designed.

The geographical distribution of consumer complaints is likely to act as a good guide for monitoring locations within the distribution system. An understanding of the distribution system is very important. Dirty water complaints predominate in dead end mains, downstream of pump stations, and in areas of flow reversal. Dirty water complaints can also occur in areas served by steel or cast iron mains, and taste and odour complaints can arise in areas with coal tar lined mains (not many left in New Zealand now). Some service reservoirs may only be used during high demand periods, such as a dry summer – the water may have been sitting around for a year and become musty.

Nothing should be taken for granted. There have been occasions when consumers have complained to the water supplier about aesthetic problems, only for the investigations to show that the 'public water supplies' were actually private bore supplies. Also, complaints of slimes and wildlife in tapwater have been traced to a storage tank below the roof; some residents do not even know they have a roof tank.

## 18.5 Aesthetic guidelines criteria

The following notes have been taken from Appendix B of the Explanatory Notes and Grading Forms of the Public Health Grading of Community Drinking-Water Supplies (MoH 2003).

These criteria are intended for use by a supplier wishing to demonstrate that their water supply meets the aesthetic Guideline Values (GVs) of the DWSNZ, for the purposes of achieving an 'A1' grade for treatment or 'a1' grade for the distribution system. Showing that these criteria are met is not mandatory, other than for gaining an 'A1' or 'a1' grade. Suppliers, however, may wish to demonstrate that their water meets these criteria for other reasons.

A supply will be considered not to have met the aesthetic guidelines if any of the following apply within the year under consideration:

- a) complaints about appearance taste and odour have not been recorded and addressed
- b) the concentration of any determinand in a monitoring sample exceeds the GV, or is outside the Guideline range stated in the DWSNZ
- c) the water has been designated as aggressive (plumbosolvent), and either the pH or CO<sub>2</sub> content is not adjusted or the consumers have not been warned annually (note: although this appeared in the 2003 Grading notes, it is no longer correct. This is now covered in the DWSNZ section 8, Priority 2C)
- d) complaints of taste and/or odour are received from an area within the distribution zone and found to be due to the GVs being exceeded
- e) complaints of black or brown-staining are received from an area within the distribution zone and found to be due to the GVs being exceeded
- f) complaints of discoloured water are received from an area within the distribution zone and found to be due to the GVs being exceeded.

Analyses must be carried out by a Ministry of Health recognised laboratory (field measurements must follow the requirements of the DWSNZ), and records of water quality complaints, and their investigations and follow-up actions, are to be kept.

An exception to these criteria is made for chlorine because of its importance as a disinfectant. It is possible that some consumers may object to the taste or odour of chlorine in the water, or that the aesthetic GV has to be exceeded to protect public health. In either case, and assuming all other criteria are being met, the supply will be considered to be meeting the aesthetic GV.

Sampling for the 'A1' treatment grading should take place at the point where water leaves the treatment plant except when lime treatment is used, in which case turbidity samples may be taken before liming.

For the 'a1' distribution system grading:

- for bulk water distribution zones, samples should be taken at the point of delivery to the satellite reticulation or tankered supply
- for reticulated or tankered supplies, monitoring samples should be taken at the point of delivery or from randomly selected consumers' taps. If a sample fails to comply with the aesthetic guidelines a confirmatory sample should be taken from a nearby house in case the problem arises from the domestic plumbing. Some pH and chlorine measurements should be made at a tap of the house closest to the treatment plant. Metal samples should be taken without flushing the tap.

The supplier may choose one of two approaches for monitoring aesthetic determinands.

### Approach 1

- At the start of each yearly cycle collect samples for all the aesthetic determinands.
- For the remainder of the year, collect samples at the frequency stated in Table 18.1. By doing the full range of determinands at the beginning of the year, this information can be used to help assess an appropriate sampling frequency for the chemically reduced determinands.

Where historical data are available for a determinand, and they show the determinand to be consistently below 50 percent of the GV, the sampling frequency for monitoring can be reduced to annual. The sampling frequency should be restored to that given in Table 18.1, if any changes to the source, treatment processes, or the distribution system are made which are likely to result in increases in the determinand concentration.

**Table 18.1: Sampling frequencies for aesthetic guidelines (ex grading)**

| Determinand  | Group   | Monitoring frequency  |
|--|---|---|
| chloride<br>hardness<br>sodium<br>sulphate<br>TDS                                    | Major ions (significant changes in the concentrations of these determinands are unlikely)   | Annually  |
| aluminium<br>chlorine<br>colour<br>pH<br>turbidity                                   | Process-linked determinands. <sup>1</sup><br>(Concentrations of these determinands may be quite variable depending on the processes in place and the way they are controlled)                   | Fortnightly <sup>2</sup>  |
| copper<br>iron<br>manganese<br>zinc  | Source or corrosion-derived metals (some variation in the concentration of these determinands can be expected depending on the aggressiveness of the water, and the nature of the source water) | Monthly   |
| ammonia<br>hydrogen sulphide   | Chemically-reduced determinands   | Annually, unless there is evidence of chemically reduced forms of nitrogen or sulphur in the water, <sup>3</sup> in which case, monthly.  |
| <b>Trace organics</b>  |   |   |
| 1,2-dichlorobenzene<br>1,4-dichlorobenzene<br>monochlorobenzene<br>trichlorobenzenes | Halogenated aromatics   | Six monthly – regular monitoring for tastes and odours (see below) can be substituted for chemical analysis for trace organics if preferred.  |
| 2 chlorophenol<br>2,4 dichlorophenol<br>2,4,6 trichlorophenol                        | Halophenols   |   |
| ethylbenzene<br>styrene<br>toluene<br>xylene   | Aromatics   |   |
| odour<br>taste   | Taste and odour   | Fortnightly – if a supplier has a method to determine threshold odour numbers.<br><br>Otherwise, the acceptability of taste and odour should be judged on the basis of consumer complaints. |

<sup>1</sup> Where a supply is not chlorinated, or not using aluminium-based coagulation, monitoring for chlorine or aluminium is not required. Iron should be included in this group if an iron-based coagulant is in use.

<sup>2</sup> Where these determinands are monitored for compliance with microbiological criteria, the results of the compliance monitoring should be used to assess whether the supply meets the aesthetic guidelines, as these data will be obtained more frequently. Where treatment processes affecting a determinand in this group are under automatic control, its monitoring frequency can be reduced to monthly.

<sup>3</sup> Very low concentrations of nitrate may indicate the presence of ammonia, and hydrogen sulphide is likely to be present if the sulphate concentration is low.

## Approach 2

- At the start of each yearly cycle collect samples for all the aesthetic determinands.
- After this, consumer complaints about water quality will be used to assess whether there is a need for chemical analysis of the water, and whether aesthetic GVs are being met.
- When complaints are received, samples should be taken to try to identify the chemical determinand(s) responsible for the complaint, and the reason for its (their) appearance in the water.
- Where complaints of a similar nature occur over an area, and the problem is not specific to particular premises, the supply will be regarded as not having met the aesthetic GVs for that year.

## 18.6 Analytical details

Some comments on the methods of analysis for the aesthetic determinands appear in the datasheets. *Standard Methods for the Examination of Water and Wastewater* 21st edition (APHA 2005) provides details of suitable methods of analysis for these determinands. In most instances a number of suitable analytical methods for each determinand are provided in *Standard Methods*. The method of choice will depend upon such factors as cost, whether the measurements have to be made in the field, availability of instrumentation, other determinands to be measured on the same sample (multi-determinand methods may be of value), whether the determinand is to be reported as total, soluble, etc, and the required sensitivity and accuracy.

The following discussion relates only to those determinands without compliance issues, ie, only aesthetic determinands. Determinands with compliance issues are discussed in their relevant Chapters (6–11), on bacterial compliance, viral compliance, protozoan compliance, cyanobacterial compliance, chemical compliance and radiological compliance. Where a determinand has both compliance and aesthetic issues, it is discussed in the relevant compliance chapter.

It is not intended to cover all aesthetic determinands here. *Standard Methods* (APHA 2005) and the datasheets give sufficient information in most cases. Some additional helpful information follows.

### Taste and odour

For taste and odour, assessment could be a better word than analysis. It is recommended that a panel be established, comprising people (not necessarily water supply staff) that have demonstrated that they have the ability to reliably recognise different tastes and odours, and to rank these based on strength. Method 2150B in *Standard Methods* (APHA 2005) gives some advice on odours and Method 2160 covers tastes. Some large water testing laboratories have modern instruments such as mass spectrometers that can be used for testing specific determinands such as those referred to earlier in this chapter.

## Total dissolved solids

Direct measurement of total dissolved solids requires a time-consuming evaporation of sample and a series of weight measurements. However, an estimate of total dissolved solids can be obtained from the conductivity measurement, which is simple and rapid. Multiplication of the conductivity (expressed in mS/m) by a factor of seven yields an estimate of the total dissolved solids in mg/L. The accuracy of this approach is adequate for most measurements required in potable waters, provided the temperature of the conductivity test is reported, and the units are correct (a common error). Note that the conversion factor is less accurate for groundwaters that have a high concentration of silica. Making total dissolved solids and conductivity measurements on a series of samples of the water of interest, and using the refined multiplicative factor obtained from these data can obtain a more accurate estimate.

## Hardness and alkalinity

Both hardness and alkalinity results can be expressed in different units. To avoid confusion, it is important that the units are clearly stated with the measurement result.

Total hardness is usually reported in units of mg/L as CaCO<sub>3</sub>. This is equal to the sum of calcium hardness and magnesium hardness, when both are expressed in units of mg/L as CaCO<sub>3</sub>. Often, calcium and magnesium are reported in concentrations of mg of Ca/L and mg of Mg/L respectively. The following factors are needed for the conversions:

$$\text{Ca in mg/L as CaCO}_3 = \text{Ca in mg of Ca/L} \times 100/40$$

$$\text{Mg in mg/L as CaCO}_3 = \text{Mg in mg of Mg/L} \times 100/24.3$$

The total alkalinity of a water is usually reported in units of mg of HCO<sub>3</sub><sup>-</sup>/L or mg/L as CaCO<sub>3</sub>. Conversion is done as follows:

$$\text{alkalinity in mg of HCO}_3^-/\text{L} = \text{alkalinity in mg/L as CaCO}_3 \times 1.22$$

In waters with pH higher than 8.3, the alkalinity to 8.3 may be reported. This value can also be reported in mg/L as CaCO<sub>3</sub>, or in mg of CO<sub>3</sub><sup>2-</sup>/L.

It is important to understand that although an alkalinity value may be reported in terms CaCO<sub>3</sub>, the value gives no indication of the amount of calcium present in the water.

## Field or treatment plant analyses

The use of sophisticated instrumentation for analysis of samples should allow good analytical results to be obtained when samples can be returned to the laboratory for analysis, and when measured online. There are often times however, when it is more appropriate for an analysis to be carried out in the field. Such situations arise when measurements have to be made in a plant for the monitoring of process performance, ie, if the result is needed very quickly. These measurements are not usually intended to determine compliance with the DWSNZ, rather they help assess the improvement, or otherwise, of process performance while changes to operating conditions are being made, or indicate at a complainant's premises, the degree of a problem with an aesthetic determinand. While laboratory analysis is perhaps more accurate, it is usually

too slow for this type of work. The relatively simple field tests can provide rapid feedback.

The detailed procedures for field analyses will be set out either in the analytical reference book from which they are taken, or in the manufacturers' instructions if a commercial test kit or online system is being used. The discussion that follows is intended to inform those without analytical training of aspects of testing that are of importance, and need to be emphasised, or that are not explicitly noted in method procedures. Although there is a small number of field tests that are carried out almost universally, a wide range of tests might be used in the field depending on the quality of the source water, and the treatment processes employed. Rather than discuss each determinand separately, the tests will be grouped according to the type of measurement method used. Field tests should be standardised regularly in the laboratory against the referee method, or against the method calibrated against the referee method.

## Titration

Determinands not related to compliance issues that may be measured in the field by titration include chloride, hardness and alkalinity.

The titrants (solutions of known concentration contained in the burette for titration) and indicators used in titration measurements will have limited lifetimes with some being very much shorter than others. Care must be taken to ensure that they are stored correctly and renewed as required by the method. The expected lifetime of titrants should be noted in the method and on the reagent bottle. Some solutions can be obtained from chemical manufacturers, otherwise a reliable analytical laboratory should be requested to prepare the necessary solutions on a regular basis.

The capacity of the burette used and the concentration of the titrant must be matched with the typical concentrations of the determinand being measured, if results of value are to be obtained. It would, for example, be inadvisable to use a 50 mL burette, graduated to 0.1 mL, if the titre (volume of titrant dispensed from the burette during the measurement) is typically 1.0 mL; the precision of these measurements would be very poor. This situation would be better approached by obtaining a smaller volume burette, say 5 mL graduated to 0.02 mL, and adjusting the concentration of the titrant to obtain larger titres so that the percentage errors in the reading are smaller.

Where a colour change in an indicator is used as the end-point of a titration, the titration should be performed on a white surface, preferably in natural light, to ensure that the end-point is seen clearly.

## Comparators and Nesslerisers

Comparators are often used for field measurements. Comparator kits are available for a range of determinands, including pH, aluminium and hardness. Colour is read using a Nessleriser.



To obtain the best results from comparators and Nesslerisers, the cells or tubes must be kept clean and unscratched, the comparator or Nessleriser is stored so the colour plates in the disc do not fade, and the correct background lighting used. Some manufacturers produce lighting units that will ensure that the appropriate background lighting is available. Natural light is usually required for accurate results (fluorescent lighting changes the apparent hue of some colours). Readings outside should be taken facing away from the sun. The instructions in many units produced in the northern hemisphere state to face north; for use in New Zealand the appropriate direction is south.

Analysts should be checked for colour blindness, and their ability to see colours reliably under different lighting conditions. Do not use people who cannot distinguish 10 and 20 Hazen units (for example). Apart from people needing to have a natural ability, the colour test is straightforward. There is usually enough technical information provided with the disc, but the method 2120B in APHA (2005) is recommended.

If the colour of the sample (for any test) approaches the upper limit of the disc, dilute the sample with clean distilled or deionised water and repeat the analysis. Multiply the recorded result by the dilution factor to obtain the final result.

## Colorimetry

Colorimetry measures the intensity of colour in solution electronically rather than estimating the colour intensity by eye. In the past, these measurements have generally had to be made in the laboratory because few treatment plants were equipped with the spectrophotometers necessary to make the measurements. There are now small, relatively inexpensive spectrophotometers available for use on the bench, and there are also portable spectrophotometers for hand use. Many of these purport to measure a very wide range of determinands, and come pre-calibrated.

All analytical instruments should be standardised, even those that are stated to be pre-calibrated. Where an instrument comes with the calibration internally set by the factory, the instrument should be sent to a qualified laboratory from time-to-time, starting when the instrument is first delivered, to determine how the reading of the instrument correlates with more reliable laboratory measurements. In addition, standard solutions of known concentration should be obtained and used to check the calibration regularly.

If the colour of the sample approaches the upper limit of the calibration limit, dilute the sample and repeat the analysis. Multiply the recorded result by the dilution factor to obtain the final result.

## General comments

See Chapter 17: Monitoring Water Treatment and Drinking-water, section 17.5 for a discussion on analytical quality control.

Chemical cleanliness is required whenever analyses are being undertaken to ensure that results are not invalidated by contamination. This is not an easy task when analyses are being performed in a water treatment plant or in the field because of the large quantities of treatment chemicals present, such as aluminium salts and lime, or dust in the air or in a vehicle during transport. The dust from these compounds, either in the air, on working surfaces, or on hands during analyses can produce misleading results.

The comments above have referred to hand-held instruments, or instruments that would be used on a lab bench. A number of determinands that can be measured by these methods can also be used online. In these instances the regular calibration of the probe, or instrument, is as important as it is for the methods used for discrete sample analysis.

## References

ANSI/AWWA B102-10. *AWWA Standard for Manganese Greensand for Filters* (19 March 2010).

APHA. 2005. *Standard Methods for the Examination of Water and Wastewater* (21st edition). American Public Health Association, American Water Works Association, Water Environment Federation.

AS/NZS 4020. 2002. *Testing of Products for Use in Contact with Drinking Water*.

AWWA. 1995. *Advances in Taste-and-Odor: Treatment and Control*. IH Suffet, J Mallevialle, E Kawczynski (eds). AWWA Research Foundation and Lyonnaise des Eaux, ISBN 0-89867-744-0.

AWWA. 2002. *Distribution Generated Taste-and-Odor Phenomena*. D Khiari, et al. AWWA Research Foundation, ISBN 1-58321-227-4.

AWWA. 2004. Problem organisms in water: identification and treatment. *Manual of Water Supply Practices*. AWWA Manual M7. Denver: American Water Works Association.

Davies, et al. 2004. Origins and implications of drinking water odours in lakes and reservoirs of British Columbia, Canada. *Water Research* 38: 1900–10.

[http://web.uvic.ca/water/publications/Davies%20et%20al%202004%20\(Water%20Research\).pdf](http://web.uvic.ca/water/publications/Davies%20et%20al%202004%20(Water%20Research).pdf).

DWI. 2014. *National Assessment of the Risks to Water Supplies posed by Low Taste and Odour Threshold Compounds*. Final Report Project WT1275. 202 pp.

<http://dwi.defra.gov.uk/research/completed-research/reports/DWI70-2-281.pdf>.

DWI. 2017. *Guidance on the Implementation of the Water Supply (Water Quality) Regulations 2016 in England and the Water Supply (Water Quality) Regulations 2010 (as amended) in Wales*. The Regulations Part 3 – Wholesomeness; Regulation 4: Wholesomeness. 4 pp. <http://dwi.defra.gov.uk/stakeholders/guidance-and-codes-of-practice/wswq/03-wholesomeness.pdf>.

EA. 1998. The assessment of taste, odour and related aesthetic problems in drinking waters. *Methods for the Examination of Waters and Associated Materials*. Environment Agency (UK).  
[https://www.gov.uk/government/uploads/system/uploads/attachment\\_data/file/316850/171\\_taste\\_odour\\_in\\_water.pdf](https://www.gov.uk/government/uploads/system/uploads/attachment_data/file/316850/171_taste_odour_in_water.pdf).

EA. 2004. The microbiology of drinking water (2004) – Part 11 – Taste, odour and related aesthetic problems. *Methods for the Examination of Waters and Associated Materials*. Environment Agency.  
[https://www.gov.uk/government/uploads/system/uploads/attachment\\_data/file/316821/mdwpart112004\\_859972.pdf](https://www.gov.uk/government/uploads/system/uploads/attachment_data/file/316821/mdwpart112004_859972.pdf).

IEH. 2014. *National Assessment of the Risks to Water Supplies posed by Low Taste and Odour Threshold Compounds*. Final Report Project WT1275. Institute of Environment and Health, Cranfield University. 202 pp.  
<http://dwi.defra.gov.uk/research/completed-research/reports/DWI70-2-281.pdf>.

The New Zealand Ministry of Health's Guides for drinking-water supplies can be accessed as Word documents on the Ministry of Health website:  
<http://www.health.govt.nz/water> then select publications and Water Safety Plans.

Ministry of Health. *Public Health Risk Management Plan Guide PHRMP Ref: P4.2. Pre-treatment Processes – Destratification*. Wellington: Ministry of Health.

Ministry of Health. *Public Health Risk Management Plan Guide PHRMP Ref: P8.1. Treatment Processes – pH Adjustment*. Wellington: Ministry of Health.

Ministry of Health. *Public Health Risk Management Plan Guide PHRMP Ref: P8.2. Treatment Processes – Iron and Manganese Removal*. Wellington: Ministry of Health.

Ministry of Health. *Public Health Risk Management Plan Guide PHRMP Ref: P8.3. Treatment Processes – Softening*. Wellington: Ministry of Health.

Ministry of Health. *Public Health Risk Management Plan Guide PHRMP Ref: P8.4. Treatment Processes – Trace Organics Removal*. Wellington: Ministry of Health.

Ministry of Health. 2003. *Public Health Grading of Community Drinking-water Supplies, Explanatory Notes and Grading Forms*. Wellington: Ministry of Health. Available on:  
<http://www.health.govt.nz/water> then select publications.

MoH. 2005. *Drinking-water Standards for New Zealand 2005*. Wellington: Ministry of Health.

NSF/ANSI 44-2004. *Residential Cation Exchange Water Softeners*. Ann Arbor, Michigan: NSF International. <http://www.nsf.org>.

NSF/ANSI 42-2005e. *Drinking Water Treatment Units – Aesthetic effects*. Ann Arbor, Michigan: NSF International. <http://www.nsf.org>.

NSF/ANSI 58-2006. *Reverse Osmosis Drinking Water Treatment Systems*. Ann Arbor, Michigan: NSF International. <http://www.nsf.org>.

Ogilvie DJ. 1986. *The Suitability of Materials for Use in Water Supplies*. Annual Conference, New Zealand Water and Wastes Association.

USEPA. 2004. Protocol for Equipment Verification Testing of Volatile Organic Chemical Removal. Environmental Technology Verification Protocol (ETV). 04/9209/EPADWCTR. Prepared by NSF. 138 pp. <http://www.epa.gov/etv/pubs/049209epadwctr.pdf>.

Webber MA, Atherton P, Newcombe G. 2014. Water. *Journal of the Australian Water Association* 41(4): 48–52.

WHO. 2004. *Guidelines for Drinking-water Quality 2004* (3rd edition). Geneva: World Health Organization. Available at: [www.who.int/water\\_sanitation\\_health/dwq/gdwq3/en/print.html](http://www.who.int/water_sanitation_health/dwq/gdwq3/en/print.html), see also the addenda.

WHO. 2005. *Legionellosis, History and Overview*. Fact Sheet #285 (February). World Health Organization. Updated to WHO (2007).

WHO. 2005. *Nutrients in Drinking-water*. WHO/SDE/WSH/05.09, 210 pp. See Chapter 12: Health Risks from Drinking Demineralised Water. World Health Organization. This is available on the internet at [www.who.int/water\\_sanitation\\_health/dwq/nutrientsindw.pdf](http://www.who.int/water_sanitation_health/dwq/nutrientsindw.pdf) and select Chapter 12.

WHO. 2007. *Legionella and the prevention of legionellosis*. J Bartram, Y Chartier, J Lee, et al (eds). Geneva: World Health Organization. ISBN 92 4 156297 8. 276 pp. See: [http://www.who.int/water\\_sanitation\\_health/emerging/legionella.pdf](http://www.who.int/water_sanitation_health/emerging/legionella.pdf).

WHO. 2011. *Guidelines for Drinking-water Quality 2011* (4th edition). Geneva: World Health Organization. Available at: [http://www.who.int/water\\_sanitation\\_health/publications/2011/dwq\\_guidelines/en/index.html](http://www.who.int/water_sanitation_health/publications/2011/dwq_guidelines/en/index.html).

WHO. 2017. *Guidelines for Drinking-water Quality: Fourth edition incorporating the first Addendum*. Geneva: World Health Organization. 631 pp. [http://www.who.int/water\\_sanitation\\_health/publications/drinking-water-quality-guidelines-4-including-1st-addendum/en/](http://www.who.int/water_sanitation_health/publications/drinking-water-quality-guidelines-4-including-1st-addendum/en/).

WQRA. 2010. *Tastes and Odours in Reservoirs*. Research Report 73. Water Quality Research Australia Limited. 98 pp. <http://www.waterra.com.au/research/knowledge-transfer/cyanobacteria-info-page/>.

WRF. 2014. *Removal of Volatile Organic Contaminants via Low Profile Aeration Technology*. 58 pp. <http://www.waterrf.org/PublicReportLibrary/4439.pdf>.

# Chapter 19: Small, individual and roof water supplies

## Contents

|             |  |           |
|-------------|--|-----------|
| <b>19.1</b> | <b>Introduction</b>  | <b>2</b>  |
| <b>19.2</b> | <b>Small water supplies</b>                                | <b>5</b>  |
| 19.2.1      | Key requirements of the DWSNZ                              | 5         |
| 19.2.2      | Preparing a water safety plan                              | 6         |
| 19.2.3      | Sanitary inspection  | 8         |
| 19.2.4      | Water quality monitoring                                   | 13        |
| 19.2.5      | Supplies not required to demonstrate compliance with DWSNZ | 16        |
| 19.2.6      | Water supplies operated under the Building Act             | 18        |
| <b>19.3</b> | <b>Individual household drinking-water supplies</b>        | <b>19</b> |
| 19.3.1      | Water sources other than rainwater                         | 19        |
| 19.3.2      | Sanitary inspection  | 21        |
| 19.3.3      | Water quality and monitoring                               | 21        |
| 19.3.4      | Water treatment  | 23        |
| 19.3.5      | Plumbing considerations                                    | 32        |
| <b>19.4</b> | <b>Roof-collected rainwater supplies</b>                   | <b>33</b> |
| 19.4.1      | Introduction   | 33        |
| 19.4.2      | Microbiological problems                                   | 34        |
| 19.4.3      | Chemical problems  | 37        |
| 19.4.4      | Maintenance problems                                       | 40        |
| 19.4.5      | Design and operation                                       | 41        |
| 19.4.6      | Information resources                                      | 48        |
| <b>19.5</b> | <b>Tankered drinking-water supplies</b>                    | <b>49</b> |
| <b>19.6</b> | <b>Rural agricultural drinking-water supplies</b>          | <b>49</b> |
|             | <b>References</b>  | <b>50</b> |

## List of tables

|   |    |
|---|----|
| Table 19.1: Common contaminants, related problems, and their likely sources   | 22 |
| Table 19.2: Contaminants and treatment methods  | 25 |
| Table 19.3: Point-of-use and point-of-entry devices and an indication of their effectiveness against various contaminants | 30 |

## List of figures

|  |    |
|--|----|
| Figure 19.1: Reducing the contamination of open reservoirs   | 9  |
| Figure 19.2: Prevention of contamination of storage tanks    | 11 |
| Figure 19.3a and b: Backflow prevention device installations | 12 |
| Figure 19.4: Typical point-of-use installation               | 26 |
| Figure 19.5: Minimising contamination of roof water          | 44 |

# 19.1 Introduction

Providing safe drinking-water for all is a cornerstone of protecting people from illness, and it is the responsibility of the water supplier/operator to ensure that the drinking-water they provide is safe regardless of the number of people served and the type of population.

Generally, the larger water supplies have more resources and lower costs per customer, so can more readily comply with the DWSNZ. In the US, small supplies (<10,000 population) account for over 90 percent of 'violations' (USEPA 2003). In New Zealand, water supplies serving <5,000 people predominate the 'non-compliances', which led to the assistance programme, see Chapter 1: Introduction, sections 1.4.6 and 1.5.

In 2002 the New Zealand Water and Wastes Association (NZWWA) in conjunction with the New Zealand Water Environment Research Foundation (NZWERF) conducted a survey of New Zealand small water systems (systems that supply water to fewer than 500 people). The survey attempted to identify how well the systems were being managed, and what difficulties the industry experienced in meeting the requirements as set out in the *Drinking-water Standards for New Zealand 2000* (DWSNZ). The objective of the report was to highlight the trends and issues facing small water systems. The interviewers undertook a visual inspection of the systems and rated the plant in the majority of systems (85 percent) as in excellent or satisfactory condition; although 'satisfactory' does not mean that they were DWSNZ compliant. The 15 percent of the systems that were rated as unsatisfactory were given this rating mainly for having no (or an inadequate level) of treatment. Only 40 percent of surface water sources were reported to be fenced, at least 20 percent of the groundwater sources had insecure head works, and 47 percent of roof water sources had no flushing points. The storage tanks for 33 percent of the systems were considered to have inadequate vermin protection or were incorrectly sealed, NZWWA (2002).

*The Drinking-water Standards for New Zealand 2005, revised 2008 and 2018* (DWSNZ) describe safe drinking-water in terms of maximum acceptable levels of contaminants (MAV), and describe how to demonstrate that drinking-water is safe. The DWSNZ include a specific section for small water supplies (section 10). Section 10 covers small and neighbourhood drinking-water supplies as defined in the Health (Drinking Water) Amendment Act 2007. Rural agricultural drinking-water supplies (RADWS) are covered by the *Rural Drinking-water Supply Guideline* (Ministry of Health 2015). See section 19.6.

Specific actions are required to be carried out and documented for small and neighbourhood drinking-water supplies. This chapter of the Guidelines provides references to a range of resources (including those available from the Ministry of Health's web page) and information to assist these water suppliers manage their supplies to ensure safe drinking-water, and to meet their obligations under the DWSNZ (see sections 19.2 and 19.3 for small and individual water supplies, respectively).

Reticulated community supplies that serve fewer than 1,500 person days (eg, fewer than 25 persons for 60 days) per year do not have to demonstrate compliance with the DWSNZ, but must still provide safe (potable) drinking-water as described in the Building Act 2004 and its amendments.

Section 19.3 provides information to assist individual household water suppliers produce safe drinking-water at a reasonable cost. Section 19.4 covers roof water, and section 19.5 covers tankered water supplies.

Readers should refer to other chapters of these Guidelines for additional information. Some helpful information also appears in AWWA (1999) *Design and Construction of Water Systems, an AWWA Small System Resource Book*.

Other chapters discuss some of the treatment processes covered in this chapter. For example, Chapter 13 Treatment Processes: Coagulation and Filtration includes lime softening and ion exchange processes, and Chapter 14 Treatment Processes: Filtration and Adsorption covers cartridge and bag filtration, and adsorption processes such as activated alumina and activated carbon.

DWI (2001) is an extensive manual on water treatment for small water supplies. It includes an interesting procedure for risk assessment in Appendix E.

WHO (2011a) discusses issues related to water quality in buildings, while WHO (2009a) addressed water supplies to schools.

WHO (2012) gives step-by-step guidance for the planning, design and implementation of water safety plans by and for rural and remote communities, including communities with piped schemes, those served by point sources and community-wide water supply services using various technical options. WHO (2014) contains short explanations of the water safety planning process (including practical templates and tips) that support WSP development and implementation in small communities. Chapter 2 of these Guidelines also covers WSPs.

The DWSNZ do not cover private water supplies. The Ministry of Health has prepared a lot of material to assist owners and operators of small water supplies. Go to [www.health.govt.nz](http://www.health.govt.nz) and click on Environmental Health, Drinking-water. The NSW Government published *NSW Private Water Supply Guidelines* in 2015; see <http://www.health.nsw.gov.au/environment/water/Pages/NSW-private-water-supply-guidelines.aspx>. The Victorian Government published *Guidelines for private drinking water supplies at commercial and community facilities* in 2010.

DWI (2016) notes that larger water supplies are increasingly choosing UV disinfection for protozoa compliance, using modern validated appliances with adequate instrumentation, monitoring and maintenance. Previously this process was not always understood resulting in inadequately disinfected water entering the distribution system. DWI found this can still be the case with smaller water supplies. They observed that:

There was a general lack of understanding amongst users regarding the treatment of their private supplies. This was compounded by the lack of information provided by equipment providers/installers.

There was no indication that UV equipment had been selected correctly for the flow or water quality.

UV equipment was generally serviced by specialist companies, plumbers or the users, with quartz sleeves cleaned at intervals between 2-12 months and lamps changed around every 12 months; the frequency of maintenance of other equipment and replacement of cartridge filters was less clear. Maintenance logs are generally not kept by users.

Monitoring and control of UV equipment is inadequate. Failure of a UV lamp may go undetected for some time because a lack of a prominent alarm, and will generally not prevent flow and the possibility of the consumption of non-disinfected water.

A UVI sensor is stipulated by all standards where UV is installed for disinfection applications in larger applications. Unfortunately such a sensor is considered desirable, but not necessarily essential, for private supply applications.

The potential for contamination of stored UV-treated water may not be well understood by users.

There is currently no licensing or approved contractor scheme applicable to the installation of equipment for private water supplies.

As a result, DWI recommends that:

- a licensing or approved contractor scheme should be implemented for installers of equipment for private water supplies
- copies of manufacturers'/suppliers' operating and maintenance instructions should be provided and retained by the supply owner. In addition, a maintenance log should be maintained by the owner to record details of maintenance carried out and schedules for future maintenance
- audible and visual alarms should be more prominent, particularly where the UV system is sited away from the user's premises



- UV systems should include automatic shutdown of the water supply in the event of power or lamp failure. An emergency valved by-pass line could be incorporated with instructions to boil drinking water prior to consumption (whilst the UV system awaits repair).

## 19.2 Small water supplies

### 19.2.1 Key requirements of the DWSNZ

A risk management approach has been adopted in the DWSNZ for small drinking-water supplies, placing the emphasis on taking action to prevent contamination in the first place and on water quality monitoring/testing as a check that the risk management actions are working.

There are two options for demonstrating that small water supplies comply with the DWSNZ:

- 1 comply with the requirements in sections 4, 5 and 7 to 9 of the DWSNZ, or
- 2 follow a Water Safety Plan (WSP – formerly known as a Public Health Risk Management Plan, PHRMP) approach to compliance (section 10 of DWSNZ). Although it is not necessary to comply with all the requirements in sections 4, 5 and 7 to 9 of the DWSNZ, any issues relating to these need to be addressed in the WSP. Water suppliers following this approach were called participating supplies.

Compliance with section 10 of the DWSNZ requires that:

- a WSP must have been approved by a drinking-water assessor (DWA) and is being implemented
- appropriate bacterial and chemical treatment, as determined from the catchment assessment in the WSP, must be in use
- appropriate protozoal treatment must be in use, following the manufacturer's instructions
- water quality must be monitored and meet specified requirements
- the remedial actions that have been specified in the WSP must be undertaken when a MAV is exceeded or treatment process controls are not met.

Reticulated community supplies serving fewer than 1500 person days (eg, 25 people for fewer than 60 days) each year are exempt from having to demonstrate compliance with the DWSNZ, but must have safe (potable) water. This means the drinking-water must not contain any contaminants that exceed the MAVs in the DWSNZ.

Section 19.2.5 provides information to assist these water suppliers produce safe drinking-water.

## 19.2.2 Preparing a water safety plan

Preparing, implementing and updating a WSP are requirements of ongoing compliance with the DWSNZ. WSPs and quality management for larger supplies are discussed in Chapter 2: Management of Community Supplies. The WHO has now adopted the principle of WSPs, which they also call water safety plans (see WHO 2012, 2014).

Risk management recognises that sometimes things will not go as planned, and aims to identify the causes of these problems and to recognise early warnings that these events are starting, and to put in place measures to control their impact. Emphasis is placed on developing plans that detail how to prevent events occurring and to respond to events when they do occur.

### Why prepare a plan

Water, whether it comes from a river, stream, lake, reservoir, rain, spring or groundwater, may be unsafe to drink. What makes water safe is the care and consideration people have for activities and actions in the areas from where the water is obtained (the catchment), and in the treatment, storage and distribution of the water.

Water suppliers have a public health responsibility to ensure that the drinking-water supplied to their communities is safe. Following a well thought-out WSP designed specifically for the supply will provide consumer confidence of consistently safe drinking-water. A WSP provides direction for improvements and expenditure, is a safeguard against changing operations staff and management, and is a learning resource for new staff.

### What is covered by the plan

A WSP is a systematic assessment of every aspect of providing safe drinking-water, identifying the events that could cause water quality to deteriorate and become unsafe to drink, and developing plans to manage these.

The WSP covers three parts of a water supply: catchment and intake; treatment; storage and distribution. It helps to identify whether any of the following four barriers to contamination are missing:

- preventing contaminants entering the source water
- removing particles from the water (where many of the pathogens/germs hide)
- killing or inactivating pathogens/germs
- preventing recontamination after treatment.

The WSP covers the following questions:

- 1 what could happen to cause the water quality to deteriorate and become unsafe to drink
- 2 which of these factors needs urgent attention

- 3 how to know when the water quality is deteriorating to a point where action is needed
- 4 how to respond if action is needed
- 5 what to do to stop deterioration happening in the future.

## How to prepare the plan

A kit has been developed to help water suppliers prepare a supply-specific WSP (*Small Drinking-water Supplies Public Health Risk Management Kit*, February 2008, available from the Ministry of Health's website <http://www.health.govt.nz>). See also Ministry of Health (2014a and b).

- Step 1 describes the drinking-water supply. A good description of the water supply starts the process of identifying what could cause the water to become unsafe to drink.
- Step 2 is based on the description of the water supply, and assesses in detail what is being managed well and where improvements are needed to ensure safe drinking-water.
- Step 3 focuses on what needs attention and develops a plan to manage these. The plan covers monitoring and inspections, emergency and incidents, standard operating and maintenance procedures and an improvement schedule. WHO (2011b) provides technical notes covering a range of emergency situations.

A range of resources are available from the Ministry of Health's website <http://www.health.govt.nz> to assist you. For a list of DVDs, go to [http://www.health.govt.nz/publications?page=2&f%5B0%5D=im\\_field\\_category%3A39](http://www.health.govt.nz/publications?page=2&f%5B0%5D=im_field_category%3A39). These include:

- Don't Bug Me! Pathogens and pathways in drinking water supplies, 2006, DVD.
- Making it Safe! Principles and methods of treatment for small drinking-water supplies, 2007, DVD.
- Checking it Out. Sampling and monitoring of small drinking-water supplies, 2007, DVD.
- Tanks, Pumps and Pipes. Small drinking-water supply reticulation systems, 2007, DVD.
- Pathogens and Pathways, and Small Drinking-water Supplies. Resources for the Drinking-water Assistance Programme, 2007, booklet.
- Treatment Options for Small Drinking-water Supplies. Resources for the Drinking-water Assistance Programme, 2007, booklet.
- Sampling and Monitoring for Small Drinking-water Supplies. Resources for the Drinking-water Assistance Programme, 2007, booklet.
- Optimisation of Small Drinking-water Treatment Systems. Resources for the Drinking-water Assistance Programme, 2007, booklet.
- Sustainable Management of Small Drinking-water Supplies. Resources for the Drinking-water Assistance Programme, 2007, booklet.

## What to do with the plan

The WSP will guide both day-to-day actions and long-term planning. It will identify regular monitoring and inspections that signal deteriorating water quality and prompt action. It will identify regular on-going maintenance to reduce the chance of failure of any of the four barriers to contamination. It will list where to get help, who needs to know what about the status of the WSP and drinking-water quality, and how quickly they need to know. It will provide direction and priorities for improvements and expenditure.

Risk management is an ongoing process, so the WSP should be reviewed at least annually. It should also be reviewed after any significant change in the catchment or to the water supply, or in response to finding a weakness in the plan. The review process should incorporate appropriate document control.

For supplies wishing to comply with section 10 of the DWSNZ, the completed WSP needs to be approved by a DWA (contact the local District Health Board). The DWA will assess the WSP and return it with a report within 20 working days. They may visit the supply periodically to see progress in using the WSP.

### 19.2.3 Sanitary inspection

A sanitary inspection of the water supply system is a necessary part of preparing, implementing and updating a WSP. It is the physical/visual assessment component of the water supply assessment step. The broader water supply assessment gathers recent and historical information about the supply to identify what could cause the water to become unsafe to drink. It reminds the supplier about previous problems, things that have been slowly changing, or sudden but short-lived changes, and extreme events that have impacted on water quality and delivery.

The Ministry of Health's *Small Drinking-water Supplies Public Health Risk Management Kit* provides useful checklists of things to consider about the catchment and intake, the treatment process, storage and distribution, and the people-aspects of water supply management.

Every effort should be made to prevent contaminants entering the source water. The catchment and intake sanitary inspection should consider:

- access to catchment by people, human excrement
- access to catchment by animals, animal excrement
- discharges to catchment such as effluent from farm practices, septic tanks and wastewater treatment plants, pesticide and fertiliser run-off or seepage, industrial waste, stormwater, seepage from landfills, underground tanks and pipes – all of which can affect surface water, springs and groundwater
- land use changes
- access and discharges to pretreatment storage
- natural events (eg, algal blooms, floods, drought and other natural disasters)
- condition of intake structure and accumulation of debris

- saltwater intrusion
- entry of contaminants to poorly constructed wells or bore heads
- deliberate damage and sabotage.

As an example, Figure 19.1 schematically shows the elements for minimising contamination of open reservoirs (pretreatment storage). Note that the water will still attract birds, and the trees will attract possums. There will, therefore, always be a certain amount of pollution of surface waters even in controlled catchments.

**Figure 19.1: Reducing the contamination of open reservoirs**

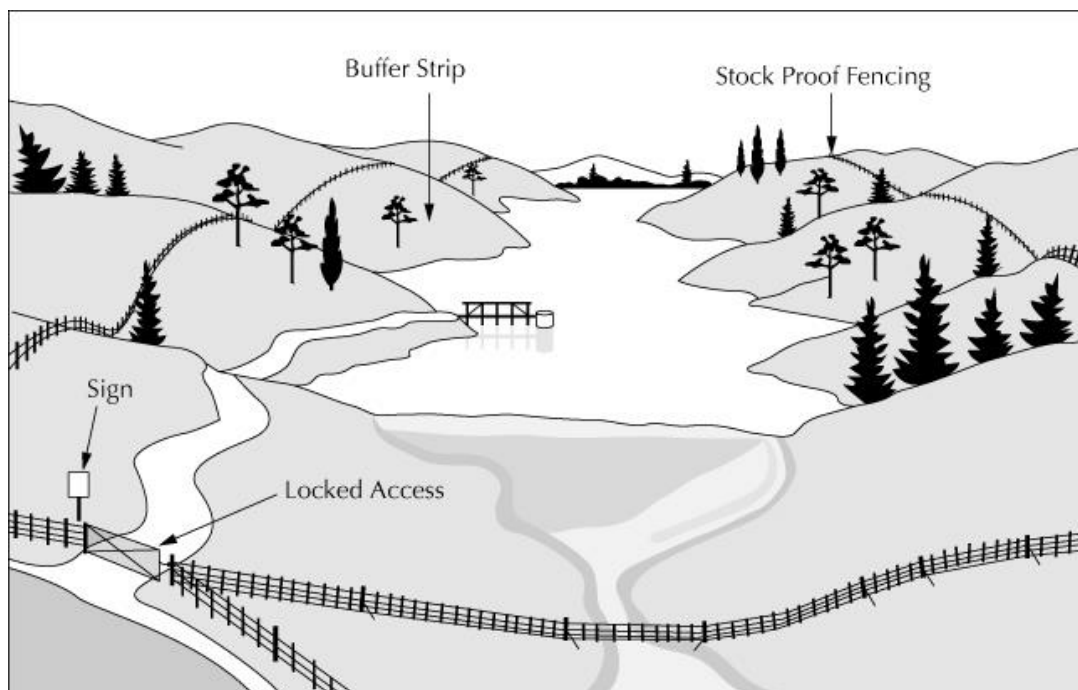

The treatment process needs to be operated in a manner that assures removal of contaminants, kills or inactivates pathogens/germs, and does not add contaminants. The treatment sanitary inspection should consider:

- condition of treatment units and parts
- the training of water supply staff
- the suitability of the treatment process for the likely contaminants
- the suitability of the operational procedures for the equipment used
- the monitoring system, alarm indication and backup equipment if faults occur
- use of approved parts and certified chemicals
- maintenance, cleaning and personal hygiene practices while working at the treatment plant
- appropriate record keeping to assist in management and troubleshooting
- security against access and vandalism or deliberate damage.

Storage/distribution needs to be protected from contamination; see Ministry of Health (2010d). The storage/distribution inspection should consider:

- maintenance, cleaning and personal hygiene practices while working on the reservoirs/tanks and distribution system
- condition of reservoirs/tanks
- security against access and deliberate damage
- interconnections between this supply and a supplementary lesser quality supply (eg, an untreated stream supply that tops up a groundwater supply)
- illegal connections
- maintenance of consistent pressure in the system
- leakage control
- use of backflow prevention devices, particularly for high-risk connections (toxic chemicals or pathogens) such as stock troughs, chemical dosing tanks and irrigation systems
- condition of pipes and fittings, releasing any build-up of corrosion products or material that have settled out from poor quality water, or allowing ingress of sub-surface water from the surrounding area into the pipes.

As an example, access of birds and animals to storage tanks has caused a number of contamination incidents. Refer to Figure 19.2 for methods of preventing contamination of storage tanks.

**Figure 19.2: Prevention of contamination of storage tanks**

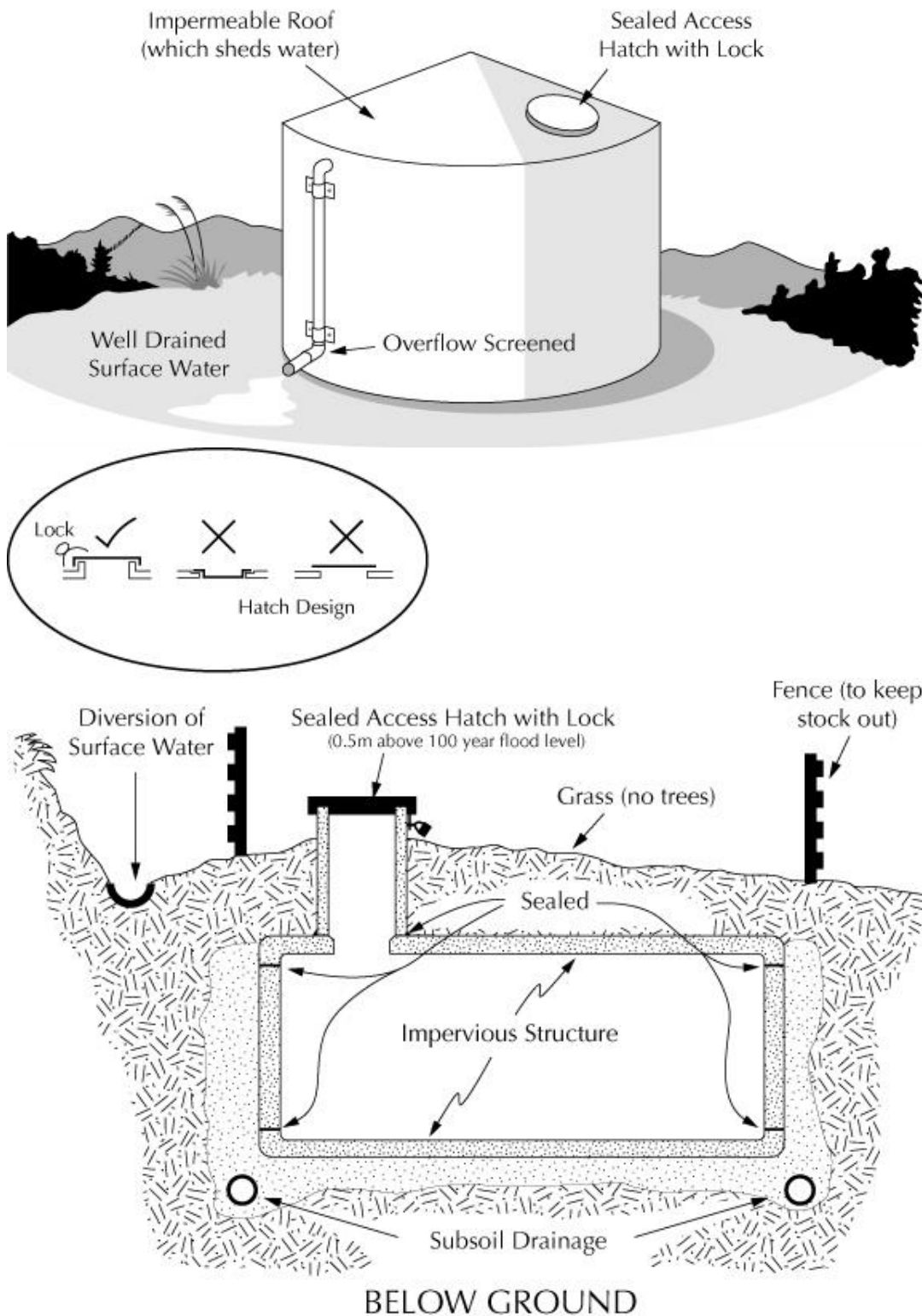

As an example, Figure 19.3 shows how potential sources of backflow can be eliminated. Backflow prevention is also discussed in Chapter 16: The Distribution System, section 16.3.2.

**Figure 19.3a and b: Backflow prevention device installations**

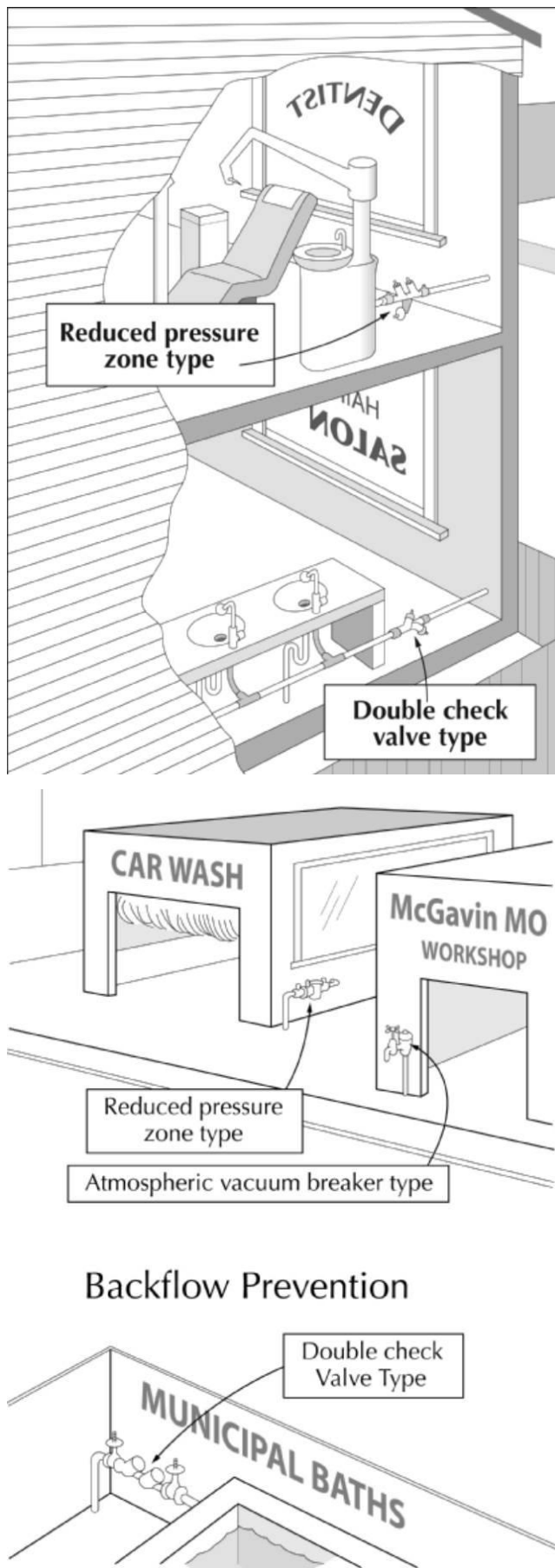



Although Figures 19.3a and b provide examples of how potential sources of backflow can be eliminated they also show examples of errors that can occur and these are listed below (details in brackets relate to clause G12 of the New Zealand Building Code):

- water supply systems must be installed in a manner that allows the system and any backflow prevention devices to be isolated for testing and maintenance (page 4, G12.3.7d and page 23 3.7.1a and b). Isolation valves are shown on the swimming pool and carwash but not on the other installations
- the hair salon is high hazard (page 18, section 3.3.1 comment c) and as such a double check valve is not sufficient (page 19, Table 2)
- all backflow prevention installations should be fitted with a line strainer upstream (page 21, 3.6.3a). None of the diagrams shows a strainer
- the atmospheric vacuum breaker on the garage hose tap is incorrectly installed; the tap/valve should be on the upstream side of the vacuum breaker and the outlet from the system should be a minimum of 150 mm above the outlet from the vacuum breaker (page 21 3.6.3d (i)–(iii))
- the double check valve in the hair salon diagram is installed backwards, ie, it would allow backflow from the sinks to enter the mains but would not allow water from the mains to flow to the sinks.

## 19.2.4 Water quality monitoring

Regular water quality monitoring and a satisfactory response to any contamination event or when the MAV of a contaminant is exceeded is a requirement of compliance with the DWSNZ. These monitoring requirements provide the check on planning and the actions taken to prevent contamination in the first place. The monitoring requirements are based on the principle that it is more effective to test for a narrow range of key contaminants frequently than to conduct comprehensive testing less often. The monitoring requirements are also based on the principle that the microbiological quality of the water is by far the most important factor in determining how safe water is from a health perspective. The Small Water Supplies section of the DWSNZ provides, or refers to, general requirements (details are to be included in the WSP) of:

- how often to take samples
- where to take samples
- who should take the samples
- who should test the samples
- for what the samples need to be tested
- what to do with the results.

From time to time there are other reasons for carrying out additional water testing. These reasons are for:

- source water assessments
- treatment selection and enhancement
- process control and operational issues

- consumer complaints
- troubleshooting.

There is no set time or place that this additional testing should be done and each individual supply has its own requirements. Most of this type of testing should be identified in the WSP. The Ministry of Health's *Sampling and Monitoring for Small Drinking-water Supplies* booklet provides useful information.

## Process monitoring of chlorine disinfection

Disinfection of a drinking-water supply by chlorination is common for small water supplies. Generally, a chlorine residual throughout the distribution system of between 0.2 and 0.5 mg/L is adequate. The amount of chlorine required to achieve this free disinfectant residual varies with the flow rate, the composition of the raw water, the water temperature, time in the distribution system, and the type of treatment.

Testing of chlorine residuals should be carried out at least weekly, preferably daily. This can be done using a simple diethyl-phenylenediamine (DPD) tablet and colour comparator or Nessleriser. Portable spectrophotometers are becoming increasingly popular. Online monitoring is highly recommended. Regular testing for residual chlorine will:

- serve as a check on the continuous satisfactory operation of the chlorinator
- indicate when the chlorine demand has increased, requiring dose adjustment
- allow savings to be made in the quantity of chlorine used
- reduce the level of complaints of strong chlorine odours, which may result from excessive or insufficient dosing.

If the water has a low turbidity and colour, and a free chlorine residual is maintained, consumers can be reasonably confident that most (if not all) pathogenic organisms will have been destroyed after a 30-minute period. Some pathogens (eg, oocysts of the protozoan *Cryptosporidium*) are more tolerant of chlorine and require removal by filtration or inactivation by another disinfection system, but chlorination is still regarded as the most appropriate key defence against contamination by bacteria and viruses. If there are perceived problems related to disinfection by-products, colour/turbidity or taste/odour, these must be addressed rather than turning off the disinfection process; see chapters 5, 6 and 15.

In addition, and provided the dose is adequate, chlorine will prevent slimes and other organisms from growing within the pipeline system so minimises the loss of hydraulic capacity and reduces the potential for biological slimes to cause tastes, odours, turbidity and colour in the water.

## Process control of other treatment

Based on the outcome of the catchment assessment (section 10.3.2 of DWSNZ), water treatment may be needed (Table 10.1 in DWSNZ) to inactivate or remove protozoa, or to remove excess colour or turbidity, or to reduce the concentration of any chemicals to below their MAV. Cartridge filtration and UV disinfection will be popular treatment options; some technical requirements are specified in the notes to Table 10.1.

A continuous UV monitor (intensity meter) is required and an alarm or fail-safe device is strongly recommended, and although not usually fitted as standard on point-of-use units, they are usually available as an extra (DWI 2001).

Section 10.3.1 of DWSNZ states that as a minimum requirement, treatment processes must be operated and monitored according to the manufacturer's instructions. That means that the water supplier must demonstrate with appropriate confidence that the UV lamp is working within specification, and the UV dose is satisfactory (which in some cases implies UVT is being measured), and the turbidity is suitable (ie, prefiltration in operation if needed). If using cartridge filtration, note 5 to Table 10.1 requires the vendor to guarantee the system will meet defined performance standards. That means the vendor must supply a test procedure for the water supplier to follow that demonstrates that the equipment is performing to specification, and will indicate when maintenance, servicing, and replacement is required. To be able to do that, the vendor must be aware of the quality of the water being disinfected.

## In summary

Instead of prescriptive compliance criteria being detailed in section 10 of the DWSNZ, individual participating water suppliers must cover these in their WSP. Water suppliers will match treatment requirements (see Table 10.1) with the results of their catchment assessment (section 10.3.2). Monitoring the effectiveness of the treatment plant is a balance between source water quality, treatment practices, network protection, and treatment plant suppliers' specifications (section 10.4.3). *E. coli* and total coliform monitoring is specified in section 10.4.2.

The WSP should address issues related to treatment plant performance, either from a compliance perspective or safety. An operator should be alerted when the treated water quality begins to deteriorate, ideally before non-compliance is reached. A system of alarms is normally incorporated into the treatment process, triggering different levels of response. A minor alarm (eg, visual or audible) could indicate some action is required within say 24 hours. A major alarm (eg, a pager) could indicate a plant inspection is required urgently or within a few hours. A critical alarm can be designed to shut down the treatment plant or part thereof.

The MoH prepared Operation and Maintenance of a Small Drinking-water Supply, see Ministry of Health (2010b), and Managing Projects for Small Drinking-water Supplies (Ministry of Health 2010c).

## 19.2.5 Supplies not required to demonstrate compliance with DWSNZ

Reticulated community supplies serving fewer than 1,500 person days (eg, 25 people for fewer than 60 days) each year are exempt from having to demonstrate compliance with the DWSNZ, but this does not absolve suppliers from the responsibility of producing safe (potable) drinking-water, as required by the Building Act 2004 and its amendments. This means the drinking-water must not contain any contaminants that exceed the MAVs in the DWSNZ.

The cost of treatment, maintenance, and water quality monitoring per consumer may be a concern for some small communities, but it is considered unwise that the health of people in the community or those visiting the community should be compromised. These very small community supplies are encouraged to adopt a WSP approach to provide adequate assurance of safe drinking-water. The processes and resources described in sections 19.2.2 and 19.2.3 are equally applicable to very small communities as they are to the fewer than 500 people communities. Useful information can also be found in section 19.3: Individual Supplies.

Responsible management of these very small community drinking-water supplies includes:

- the skills and knowledge of the people responsible for operating and maintaining the supply are adequate for the type of system operated
- raw water sources and storage are inspected regularly for any source of contamination (see section 19.2.3)
- all equipment and plant are maintained in good condition, inspected regularly, and a maintenance routine is in place
- treatment is provided where the quality of raw water is poor, and appropriate treatment selection is based on known source water quality and variability. The Ministry of Health's *Treatment Options for Small Drinking-water Supplies* booklet provides useful information
- disinfection should be considered for water entering the distribution system, preferably with chlorine or using technology that is effective for removing or inactivating microbiological contamination
- the level of attention to water quality should be increased during periods when water quality is known to be poor. Indicators of poor water quality are turbidity (murkiness), the absence of a free available chlorine residual and the presence of *E. coli*. The indicators will help in deciding whether the barriers to contamination are adequate at times of greatest need. They will also assist in assessing the need for action and the extent of action required
- distribution pipes are cleaned/flushed to remove any build-up of corrosion products or material that has settled out from poor quality water
- treatment and storage facilities are secure and cleaned regularly
- potential sources of backflow are eliminated and reasonably constant pressure in the distribution system is maintained

- funds are set aside to ensure that repairs/maintenance can be carried out when required
- plans are in place to manage deteriorating drinking-water quality before the water becomes unsafe to drink, including knowing the signs of deteriorating water quality or treatment plant performance, knowing when to take action, knowing what actions to take, and who will take the actions.

Where water quality or quantity problems occur, they must be investigated thoroughly and the risks to the community assessed. The options may then be to:

- inform the community of the problem, the actions being taken, and advise what actions individual households should take while the problem is being attended to, eg, boil water:<sup>1</sup> see section 3.1 of WHO (2009) for a discussion on issues related to boiling
- if a permanent 'Boil Water' notice is issued, approved signage must be displayed next to all taps connected to the supply
- check the operation of the existing system to ensure that the complete system is working as designed
- thoroughly clean the system and flush the system to waste
- seek an alternative source of raw water or upgrade the existing source
- upgrade the barriers to contamination in order to achieve potable drinking-water
- as a last resort, declare the supply non-potable and recommend alternatives.

## Microbiological quality and monitoring

The microbiological quality of water is by far the most important factor in determining the safety of water supplies from a health perspective. Good microbiological quality in very small water supplies can be achieved by:

- regular sanitary inspections
- routine system maintenance
- adequate disinfection
- monitoring/testing for microbiological indicator organisms.

Barriers for preventing contamination must be effective. Routine sampling and analysis of the microbiological quality of the water during periods of higher risk can help in detecting contamination problems, and in determining whether these have arisen at the water source, during treatment, or in the distribution system. As a minimum, these very small community drinking-water supplies should be monitored for the four determinands that best establish the sanitary state of the water:

- *E. coli* and total coliforms
- pH
- disinfectant residual (may not be relevant for secure bore water supplies, or for ultraviolet light irradiated water)
- turbidity (monitoring frequency will be less for secure bore water supplies).

<sup>1</sup> Chapter 6 includes an Appendix: Boil Water Notices.

Note that secure bore water is defined in the DWSNZ, and is explained in Chapter 3 of the Guidelines.

Except for the indicator micro-organisms, the above determinands can be tested on-site using relatively simple testing equipment. This is essential for disinfectant residuals, which must be measured at the time of sampling. It is also important for the other determinands where laboratory support is lacking or where transportation problems would render conventional sampling and analysis difficult or impossible.

Test kits are available for rapid microbiological examination of water, but the results obtained may be variable and require careful interpretation. A coliform presence/absence test (P/A) may be used for process control monitoring, and for testing the water supply for compliance with the DWSNZ. But when total coliforms or *E. coli* are found when using presence/absence kits, the correct response should be to consider that the drinking-water supply is contaminated; a more rigorous method must be used for repeat tests so that a numerical result (the number of organisms can be counted) can be obtained. Although microbiological test kit analyses are relatively simple and cheap, expertise in their use and strict compliance with the instructions are required.

To enable a small drinking-water supply to be monitored adequately, the water supplier may wish to consider using the services of a volunteer from the community. Suitable personnel can be selected after consideration of where their premises are, and whether they have previous experience such as operating a swimming pool. The water supplier should call periodically to cross-check results and to replace reagents and equipment as required. Advice can be obtained from drinking-water assessors.

Any person undertaking the monitoring or operation of a community water supply should receive adequate training, reference material, and contact personnel to enable them to perform their functions responsibly, with a full understanding of the requirements and purpose of their duties.

## 19.2.6 Water supplies operated under the Building Act

Many drinking-water supplies in New Zealand are self-supplied drinking-water systems, eg, rural schools, marae, and camping grounds. The water is not delivered to individual buildings via a distribution system, but distributed across the owner's property by their own plumbing system. Self-supplied drinking-water systems are subject to the requirements of the *Building Act* 2004.

Section 19.2.5 (Small Community Supplies not Required to Demonstrate Compliance with DWSNZ) should be used as a guide for these self-supplied drinking-water supplies.

Refer to section 19.3 for matters related to individual household drinking-water supplies.

## 19.3 Individual household drinking-water supplies

An individual household drinking-water supply is a stand-alone system that is not connected to a community drinking-water supply. Individual household supplies have a responsibility to produce safe (potable) drinking-water as described in the *Building Act* 2004 and its amendments. Approved Document G12 Water Supplies requires premises to be provided with potable water for oral hygiene, utensil washing and food preparation. Bathing, showering, and toilet flushing can use non-potable water such as salt water or stream water, provided it is not detrimental to health. Under section 39 of the *Health Act* 1956, it is illegal to let or sell a house unless there is a supply of potable water.

Water, whether it comes from a river, stream, lake, reservoir, rain, spring or groundwater, may be unsafe to drink. What makes water safe is the care and consideration people have for activities and actions in the areas from where the water is obtained (the catchment), and in the treatment, storage and distribution of the water, affecting the raw water quality and the safety of the final product. This section provides information to assist individual household water suppliers produce safe drinking-water at a reasonable cost. For further information on design of individual household drinking-water supplies refer to (available from district health board offices):

- *Household Water Supplies*, Ministry of Health, 2001, revised 2016
- *Water Collection Tanks and Safe Household Water*, Ministry of Health, 1999, revised 2014
- *Secure Groundwater Bores and Wells for Safe Household Water*, Ministry of Health, 2000.

Further useful information can be found in the resources listed in section 19.2.2 for small community supplies. MoH drinking water publications can be found at <http://www.health.govt.nz/our-work/environmental-health/drinking-water/drinking-water-resources>.

The WHO published *Managing Water in the Home: Accelerated health gains from improved water supply* and is available on the internet (WHO 2002).

### 19.3.1 Water sources other than rainwater

Waters from different sources tend to have different qualities. These are summarised in Chapter 4: Selection of Water Source and Treatment, Table 4.1: Source Water Quality. This table may be used as a guide in determining how much risk is associated with a particular source, and therefore what degree of treatment and vigilance is necessary to ensure safe drinking-water. The characteristics listed in the columns headed Chemical Quality and Aesthetic Quality are sometimes interrelated. For example, soft corrosive waters can cause high concentrations of some metals due to corrosion of plumbing materials.



Apart from some chemicals in geothermal or hydrothermal waters (most frequently boron, arsenic and fluoride), and corrosion metals such as lead, the principal health risk is usually from the presence of illness-causing micro-organisms. Therefore microbiological quality should be given the most attention.

## Groundwater

Groundwater as a source for drinking-water is discussed in Chapter 3: Source Waters, section 3.2. Also, see *Design and Operation of Bores for Small Drinking-water Supplies* (Ministry of Health 2010a).

The key points about groundwater are:

- most groundwater used for individual household supplies is likely to be from bores drawing from shallow systems
- these shallow systems should be treated as if they were surface sources, ie, susceptible to contamination from surface activities, and therefore likely to require treatment, particularly disinfection
- a properly constructed and protected bore head, and an adequate separation between the bore and any septic tank or other wastes, are important in preventing contamination from surface activities, see Chapter 3: Source Waters, Figure 3.2: sanitary protection of a typical bore
- groundwater can contain elevated levels of nitrate from farm run-off and seepage (fertiliser application and stock effluent), and from septic tank effluent; health effects from nitrate at or above the MAV of 50 mg/L as NO<sub>3</sub> are restricted to infants, see datasheet
- some groundwater can contain elevated levels of iron and manganese, which when exposed to the atmosphere or are chlorinated, can appear as brown/orange and black staining or particles
- some groundwaters contain high levels of carbon dioxide which can cause metallic corrosion eg, copper pipes, see Chapter 10
- some groundwater can also occasionally have odours and tastes associated with them, usually H<sub>2</sub>S, however these are not necessarily indicators of any health risk.

## Surface water

Surface water as a source for drinking-water is discussed in Chapter 3: Source Waters, section 3.3. Surface water is water from streams, rivers, ponds, lakes, reservoirs, springs and shallow unconfined groundwater systems. Roof water is discussed in section 19.4. In areas where roof water may offer an inadequate supply, surface water can be used for non-potable purposes such as garden watering. Taps providing non-potable water should have suitable signage.



The key points about surface water are:

- it is necessary to regard surface water as unsafe for use in a household unless reliable treatment is provided because it is susceptible to contamination from surface activities
- surface water from streams, rivers and lakes draining catchments that are highly modified by human and animal impacts will have higher turbidity (murkiness). These sources are likely to be contaminated by animal effluent, sewage effluent, agricultural fertilisers, and possibly industrial waste discharges. They may also have high algae concentrations during summer. In some parts of the country, surface waters can be affected by geothermal activity which can cause health effects over a long period of exposure
- a controlled surface water catchment is one where animals or people are prevented (unless a permitted entry is allowed) from entering. Such a catchment is often well-vegetated and the water usually has a low turbidity, but may have moderate to high colour, depending on the vegetation and soil type. These sources may undergo rapid increases in turbidity and colour following heavy rainfall. Feral animals (eg, possums) and birds (eg, scavengers such as seagulls and ducks) are often present, introducing illness-causing micro-organisms.

### 19.3.2 Sanitary inspection

A sanitary inspection is the physical/visual assessment of a drinking-water supply from catchment to tap that identifies what could happen to cause water quality to deteriorate and become unsafe to drink. The processes described in section 19.2.3 are equally applicable to individual household supplies as they are for small community supplies.

### 19.3.3 Water quality and monitoring

The microbiological quality of water is by far the most important factor in determining the safety of water supplies from a health perspective. Good microbiological quality in individual household drinking-water supplies can be achieved by:

- regular sanitary inspections
- routine system maintenance
- adequate disinfection
- monitoring/testing for microbiological indicator organisms.

Common contaminants, the problems they cause, and their likely origins, are shown in Table 19.1.

**Table 19.1: Common contaminants, related problems, and their likely sources**

| Cause                              | Problem  | Likely source  |
|------------------------------------|--|--|
| Aggressiveness                     | Corrosion, taste and staining  | Soft low pH water (eg, rainwater) and bore water containing CO <sub>2</sub>  |
| Arsenic                            | Poisonous to humans  | Water containing geothermal fluids   |
| Bacteria                           | Waterborne disease   | Human and animal wastes  |
| Boron                              | Possible health problems   | Water containing geothermal fluids   |
| Colour                             | Appearance, taste, staining  | Natural decaying vegetative matter, or high manganese/iron   |
| Copper                             | Possible health problems. Taste and staining (blue water) can occur at lower concentrations  | Corrosive water and plumbing materials   |
| Hardness                           | Scale, excessive soap use and increased maintenance of water heating elements  | Dissolution of limestone-type rocks  |
| Iron                               | Staining, taste, pipe clogging   | Soluble iron salts produced by reduction in oxygen-free conditions, usually bore water   |
| Lead                               | Poisonous to humans, especially infants, young children and unborn babies  | Corrosive water and older plumbing materials/roof paints   |
| Manganese                          | Possible health problems if above 5 mg/L. Taste and staining can occur at lower concentrations   | Soluble manganese produced by reduction in oxygen-free conditions, usually bore water  |
| Nitrate                            | Bottle fed infants can have breathing problems (blue baby syndrome)  | Fertilisers, sewage, animal effluent, clover pasture   |
| pH                                 | When less than 6.5, corrosion of plumbing materials, possibly causing copper or lead to be dissolved into the water  | Soft water, CO <sub>2</sub> rich groundwaters  |
|                                    | When greater than 8.5, scale formation in hot water cylinders and on heating elements causing reduced efficiency and premature failure. Also can cause excessive scale build-up in pipes | Many groundwaters  |
| Protozoa                           | Waterborne disease   | Human and animal wastes  |
| Taste and odour causing substances | Taste, odour   | Many causes including algae, minerals, chlorination by-products, leaching of organic materials from plumbing materials, corrosion products |
| Turbidity                          | Appearance, and interference with disinfection   | Suspended particles of natural and human or animal origin  |
| Viruses                            | Waterborne disease   | Human and animal wastes  |

Water supply owners should have the water being used for drinking, cooking and food preparation tested for microbiological indicator organisms (eg, *E. coli*) at least once every six months.

A specialist water testing laboratory should be used, and can give advice on the correct procedures and container to be used when taking samples (see Laboratories – Analytical, and Laboratories – Testing in the Yellow Pages; but check that they routinely carry out water quality analyses). The laboratory used should be on the list of analytical laboratories recognised by the Ministry of Health as suitable for carrying out compliance testing related to the DWSNZ. Advice is also available from Drinking-water Assessors (contact your local public health protection unit through your District Health Board). IANZ accredited and MoH recognised laboratories are listed in <http://www.ianz.govt.nz/>.

Other contaminants should be tested when there is a change in the source or treatment process, or every two to three years, or when there is some cause for concern. Cause for concern may arise because of a new or worsening problem with the water (see Table 19.1 for some of the more common contaminants and their related problems). If analysis shows that a particular contaminant has reached or is greater than 50 percent of its MAV (refer to DWSNZ), the cause should be investigated and it should be monitored every three months until it has dropped below the 50 percent level, and/or the source of the contamination is removed or controlled.

### 19.3.4 Water treatment

The purpose of treating water is to ensure reliable safe (potable) water for the household or buildings. Anything less than microbiological safety is placing members of a household at risk. Only the water used in drinking, washing, cooking, and food preparation is required to be both microbiologically and chemically safe. This typically represents only two to three percent of household consumption. It is recommended that, if the whole supply is not being treated, to ensure safe drinking-water, as an absolute minimum, the water used for the above purposes should be treated to the required standard using a point-of-use or point-of-entry device (see below). Labelling of pipes and outlets is extremely important especially for visitors and future owners (refer New Zealand Building Code Approved Document G12: Water Supply). Labelling of pipes helps prevent cross-connections between potable and non-potable waters. When the water is unsafe, a notice at points of use should advise consumers to boil water for all water used for drinking.

Bore water proven to be secure should not need any treatment, at least for microbiological contamination. However, for some groundwater, treatment of the whole supply may be necessary to remove or control specific chemical contaminants, eg, carbon dioxide (see Chapter 12: Pretreatment Processes), iron and manganese (see Chapter 18: Aesthetic Considerations). Proving bore water is secure can be very expensive so it is recommended to assume that it is equivalent to surface water.

Treatment selection should be based on known source water quality and its variability. This requires repeated testing over a period of time to select a treatment process that will be effective over the range of source water quality. In particular, a sample should be tested when the source water is considered to be at its worst quality and at its best. A specialist water testing laboratory should be used, and the results made available to a drinking-water treatment specialist/consultant (see Table 19.1 for some of the more common contaminants and their related problems).

Table 19.2 summarises the common contaminants found in water, and some possible methods of treatment (suitable for individual supplies) for these contaminants. The Ministry of Health's *Treatment Options for Small Drinking-water Supplies* booklet provides additional information. The discussions that follow provide further detail on some of these treatment options. Refer to Chapters 12–15 for a more in-depth discussion about methods for water treatment and disinfection. Chapter 18 includes some treatment processes for the control of aesthetic determinands.

Water treatment systems for individual households fall into two main groups:

- point-of-entry (POE), where the water is treated 'at the gate' or boundary
- point-of-use (POU), which is usually associated with the kitchen tap, commonly installed under the sink. Sometimes they are installed under the bathroom basin as well. If POU rather than POE is used, the potential risk exists of drinking water from the wrong tap.

The World Health Organization (WHO 2016) has begun evaluating household water treatment technologies. After their first round of testing they concluded:

- only half of the 10 products evaluated were found to provide comprehensive protection against all three pathogen classes
- two of the products evaluated were found to not meet the any of the minimum performance targets
- two of the products evaluated (a membrane ultrafiltration device and a solar disinfection indicator) did not consistently meet the required performance targets across all samples
- manufacturer testing, in some cases, is insufficient to support claims as testing does not cover all three classes of pathogens
- existing testing is often conducted under ideal conditions that are not reasonably reflective of actual use in the field
- unclear instructions and product labelling were observed in two products
- national regulations are generally weak.

Membrane filters are split into categories depending on the size of the pores. In decreasing order of pore size, the categories are microfiltration (MF), ultrafiltration (UF), nanofiltration (NF) and reverse osmosis (RO); they are discussed individually. For small supplies they are usually in the form of a cartridge.

Section 19.4 discusses rainwater/roof water systems and their treatment options. Section 19.3.5 covers plumbing considerations.

**Table 19.2: Contaminants and treatment methods**

| Contaminant                   | Treatment   |
|-------------------------------|---|
| Arsenic                       | Cartridge filtration if arsenic is particulate; strong base anion exchange or reverse osmosis if soluble. Activated alumina   |
| Bacteria                      | Ultraviolet light (only effective in low turbidity/low colour waters and while lamps performing near full efficiency)<br>Ozone, chlorine, reverse osmosis, boiling, nanofiltration                      |
| Boron                         | Ion exchange  |
| Carbon dioxide                | Aerate; add calcium carbonate, marble, dolomite granules or chips   |
| Colour                        | Activated carbon, reverse osmosis   |
| Copper                        | Make water less corrosive, treat as for carbon dioxide. If copper present in source water (unlikely) other treatment will be necessary so seek specialist advice  |
| Hardness                      | Ion exchange, water softening, reverse osmosis  |
| Iron                          | Aerate and filter, chlorinate and filter, ion exchange (if soluble)   |
| Lead                          | Remove source of lead. Use approved fittings. Make water less corrosive, treat as for carbon dioxide. If present in source water (unlikely) other treatment will be necessary so seek specialist advice |
| Manganese                     | Aerate, chlorinate and filter, potassium permanganate and filter, ion exchange (if soluble)   |
| Nitrate                       | Ion exchange or reverse osmosis; use alternative source for infants   |
| pH                            | If too low, treat as for carbon dioxide; if too high, treat by ion exchange (but rarely necessary)  |
| Protozoa                      | Boil, cartridge filter (1.0 µm nominal pore size), ozone, ultraviolet light, reverse osmosis, nanofiltration, ultrafiltration, microfiltration  |
| Taste and odour (many causes) | Activated carbon, boil, reverse osmosis   |
| Turbidity                     | Cartridge filter, reverse osmosis, nanofiltration, ultrafiltration, microfiltration   |
| Viruses                       | Chlorine, reverse osmosis, boil, nanofiltration   |

## Point-of-entry systems

POE systems usually treat all the water entering a property or a cluster of buildings, for domestic purposes. Capital costs are usually higher but the plumbing may be simpler. The larger treatment units can incorporate some degree of automation such as routine backwashing, water quality monitoring becomes more cost-effective, and they can be operated by trained staff.

POE systems have been used where a non-potable supply (eg, irrigation water) passes a village or cluster of buildings; the local authority installs or supervises an approved POE system, and then monitors the water and maintains the equipment. POE systems can feed into a storage tank.

## Point-of-use devices

Many people use the cheap, effective point-of-use (POU) device found in most kitchens: an electric kettle. If water is boiled for a minute, all biological (including *Cryptosporidium* oocysts and *Giardia* cysts) and most gaseous contaminants will be removed or destroyed; most chemicals will be unaltered.

Other POU devices are like a miniature water treatment plant and can be used to treat all household water, or even be put on the end of a tap, for producing drinking-water only (see Figure 19.4). A potentially serious limitation with POU devices is that there will invariably be other taps in a dwelling without a POU device and people will need to be able to identify these, and accept that they should not be used for drinking.

**Figure 19.4: Typical point-of-use installation**

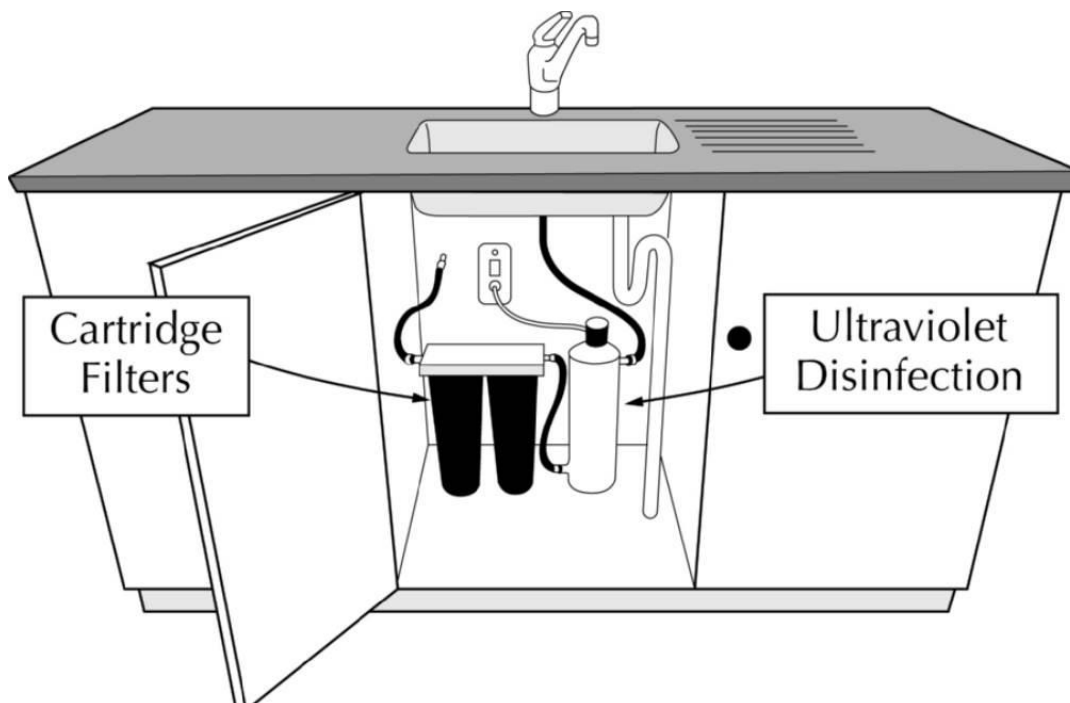

There is a wide range of POU devices on the market. They are available as plumbed-in, tap mounted, and stand-alone units. The POU devices available vary widely in quality, type and performance. Their effectiveness has a number of considerations, such as knowing:

- the quality of water that the device needs to treat
- the device can cope with this incoming quality
- the device can cope with the anticipated quantity and flow rate
- the device is being operated, maintained and serviced appropriately
- when the device has failed, either physically, or is no longer producing potable water. Preferably there should be a warning that this state is approaching because these systems usually do not include any (or much) treated water storage so there is very little time to remedy the situation.

It is important to get clear written specifications from the vendor about what determinands the device will treat, and perhaps more importantly, what it will not treat. This should then be compared with the source water quality and its variability. It is also advisable to ask for validated New Zealand tests for the performance claimed by the manufacturer and vendor. In the event of the purchased device not being suitable for its purpose there may be a remedy available under the *Consumer Guarantees Act 1993*.

Where communities rely on household water treatment, WHO (2006a) considers water authorities should initiate programmes and work to ensure that a range of these technologies or systems are available, such that consumers can choose what is acceptable, affordable and appropriate for their household. As a minimum they should work to ensure that the training and information that consumers need to make good decisions is available. Authorities should also monitor these situations to be sure that the household treatment is functioning successfully.

With recent research indicating that household-based approaches to managing water are cost effective, WHO has taken the lead in coordinating the International Network to Promote Household Water Treatment and Safe Storage (WHO 2006b). WHO (2002) describes many household treatment and storage techniques.

Neglected maintenance is one of the biggest problems with POU devices (the other being selection of an inappropriate system for the contaminants of concern). For example, many micro-organisms can accumulate and grow in or on poorly maintained devices, or systems designed to remove tastes/odours (eg, activated carbon filters). It is important to be familiar with the maintenance and replacement requirements of each treatment unit. Some units require more maintenance than others. All POU units should be maintained according to the manufacturer's recommendations. Some units have dealer or manufacturer maintenance contracts available to ensure proper operation over the life of the unit. One of the major problems is the difficulty of knowing when a point-of-use device has ceased to function effectively. Use-by dates or the manufacturer's instructions as to the maximum volume of water that can be treated should be strictly adhered to. It could be helpful to install a water meter or to measure pressure loss across the device. Once again, reputable suppliers should offer sound advice.

Table 19.3 shows the different types of POU and POE devices and their effectiveness against various contaminants when used and maintained properly. A POU device should state clearly and permanently on its casing, what type of unit it is and what it will and will not achieve.

NSF/ANSI have published the following standards (note: these are updated frequently):

Point-of-entry and point-of-use systems designed for the removal of aesthetic determinands are covered by NSF/ANSI 42-2005e. Determinands included are chloramines, chlorine, hydrogen sulphide, iron, manganese, zinc, particulates, and pH adjustment.

NSF/ANSI 44-2004 *Residential Cation Exchange Water Softeners* is designated as an ANSI standard. See Chapter 13: Coagulation Processes, section 13.6: Lime Softening and Ion Exchange for further information. Some discussion related to water softening also appears in Chapter 18: Aesthetic Considerations, section 18.3, under the heading of Hardness.

NSF/ANSI 53-2006 *Drinking water treatment units – Health effects* (with Addendum No. 1) is a standard that establishes minimum requirements for design and construction, and performance of drinking-water treatment systems that are designed to reduce specific health-related contaminants in public or private water supplies.

- Clauses 7.2.1 and 7.2.4 cover organic chemical reduction
- Clause 7.2.2 covers inorganic chemical reduction (fluoride, nitrate)
- Clause 7.2.3 covers radon reduction (POU activated carbon)
- Clause 7.3.2 covers (oo)cyst reduction
- Clause 7.3.3 covers turbidity reduction
- Clause 7.4.1 covers arsenic reduction (RO)
- Clause 7.4.2 covers general metals reduction
- Clause 7.4.3 covers lead reduction
- Clause 7.4.4 covers mercury reduction.

NSF/ANSI 55-2004 *Ultraviolet Microbiological Water Treatment Systems* is designated as an ANSI standard for point-of-use units. This specifically covers point-of-entry and point-of-use systems.

NSF/ANSI 58-2006 *Reverse Osmosis Drinking Water Treatment Systems* is designated as an ANSI standard for point-of-use units.

NSF/ANSI 61-2017 *Drinking Water System Components – Health Effects*.

NSF/ANSI 62-2004 *Drinking Water Distillation Systems* is designated as an ANSI standard.

NSF/ANSI 419-2015 *Public Drinking Water Equipment Performance – Filtration*.

Discussion of point-of-use systems appeared in the July and November 1995 issues of *Water and Wastes in New Zealand*, nos. 86 and 88. See USEPA (2006) for an extensive discussion on POU/POE treatment systems. Section 7 in USEPA (2003) discusses point-of-use and point-of-entry (POU/POE) units too. WHO (2012a) produced a Toolkit to help assess correct and consistent use of household water treatment and safe storage by those most at risk.

Three very good handbooks have been published in recent years, see CRC (2007), British Columbia (2007) and USEPA (2006a). Costs are discussed in USEPA (2007).

See also: Ministry of Health. 2010e. *UV Disinfection and Cartridge Filtration: Resources for Drinking-water Assistance Programme*.



## Chlorination

Individual household supplies may use chlorination to disinfect the water. Disinfection by chlorination must be controlled carefully – both the dose and the contact time, before using the water. The chlorine should be dosed to give a free available chlorine (FAC) level of at least 0.2 mg/L in the water 30–60 minutes after mixing. Enough FAC needs to be added to destroy the pathogens/germs, but too much may cause consumers to complain about taste and odour. Disinfection using chlorine can be done on either a batch basis, or by using a proprietary chlorinator that doses chlorine into the water as it is drawn and stored, as used at school swimming pools. The FAC can be measured using a test kit based on the DPD colorimetric method or by a combination test kit that includes pH measurement. These kits come with all necessary test tubes, chemicals, colour chart and instructions, and are available from swimming pool chemical suppliers and some pharmacies.

The compounds of chlorine most commonly used for batch dosing are sodium hypochlorite (ordinary, unscented, uncoloured, fresh, household bleach, a liquid) or calcium hypochlorite (swimming pool chlorine, powder or granules). For water that comes from very safe to reasonably safe sources a dose of either:

- 4 to 7 mL of sodium hypochlorite bleach per 100 litres of water; make sure it is fresh stock (at 3 percent available chlorine this is equivalent to a dose of 1 to 2 mg/L) or
- 0.15 to 0.3 g of calcium hypochlorite (65 percent available chlorine) per 100 litres of water

will generally give the required free available chlorine residual. The disinfected water should be left to stand overnight before use. The Ministry of Health's *Household Water Supplies* booklet has tables of chlorine dose (sodium hypochlorite bleach and calcium hypochlorite) for other tank volumes. CDC (2009) discusses emergency disinfection of drinking water, including disinfecting wells.

It is advisable to keep records of the disinfection, eg, dates, doses and volumes, so the process can be fine-tuned as experience accumulates. Records will be helpful when different people treat the water, when the raw water quality varies, and for troubleshooting.

WHO (2011) discusses some household water treatment options.

**Table 19.3: Point-of-use and point-of-entry devices and an indication of their effectiveness against various contaminants**

| Contaminant                | Activated carbon (1) | Boiling (4) | Ceramic candle (2) | Cartridge filtration (2) | Home distillation (13) | Reverse osmosis (8) | Water softener (7, 8) | Ultra-filtration (8) | Ultraviolet light (6) | Calcium filtration (9) | Oxidising systems (16) |
|----------------------------|----------------------|-------------|--------------------|--------------------------|------------------------|---------------------|-----------------------|----------------------|-----------------------|------------------------|------------------------|
| Arsenic (11)               | P                    | N           | N-G                | N-G                      | M-Ex                   | G-Ex                | G (7)                 | N-G                  | N                     | P-G                    |                        |
| Bacteria                   | N (1)                | Ex (4)      | P-G                | P                        | Ex                     | M                   | N-P                   | M                    | Ex (6)                | P                      |                        |
| Boron                      | N                    | N           | N                  | N                        | Ex                     | N                   | Ex                    | N                    | N                     | N                      |                        |
| Carbon dioxide/corrosivity | P                    | G           | N                  | N                        | M                      | P                   | P                     | N                    | N                     | G-Ex                   |                        |
| Colour                     | M (3)                | N           | N                  | N                        | Ex                     | G                   | P                     | P-M                  | N                     | N                      |                        |
| Hardness                   | P                    | M (5)       | N                  | N                        | Ex                     | P-M                 | G (7)                 | P                    | N                     | N                      |                        |
| Iron, soluble              | P                    | N           | N                  | N                        | Ex                     | G                   | G-Ex (7)              | M                    | N                     | P-M                    | G                      |
| Manganese, soluble         | P                    | N           | N                  | N                        | Ex                     | G                   | G (7)                 | M                    | N                     | P-M                    | G                      |
| Nitrate                    | P                    | N           | N                  | N                        | Ex                     | G                   | G (7)                 | P                    | N                     | N                      |                        |
| Protozoa cysts/oocysts     | G (2)                | Ex (4)      | G-Ex               | G (2)                    | Ex                     | Ex                  | N                     | Ex                   | G (15)                | P (10)                 |                        |
| Taste and odour            | G-Ex (3)             | M (12)      | N                  | N                        | M                      | M                   | P                     | P                    | N                     | P                      | M                      |
| Turbidity (14)             | M                    | N           | P-M                | P-G                      | Ex                     | Ex                  | M                     | Ex                   | N                     | P                      |                        |
| Viruses                    | N (1)                | Ex (4)      | P                  | P                        | Ex                     | Ex                  | P-M                   | Ex                   | P-Ex (15)             | P                      |                        |

Terms used in table:

Ex excellent removal, where equipment is in good condition

G good removal to an acceptable level

M moderate removal, constituent may still give a problem

P poor performance, most of constituent levels unaffected

N no removal at all

Notes:

Activated carbon filters can be either POE or POU.

Boiling, ceramic candle, cartridge filtration, home distillation, reverse osmosis tend to be used as POU systems.

Water softening, ultra-filtration, ultraviolet light, calcium filtration, and oxidising systems tend to be used for POE treatment.

See Chapter 9, section 9.7.2.4 for brief comments related to removal of cyanotoxins.

Explanatory notes for Table 19.3:

- 1 Activated carbon filters should not be used for water containing biological contaminants unless there is a subsequent reliable disinfection stage. Activated carbon can act as a growth medium for micro-organisms. WHO (2003) states in Chapter 12.4 that Health Canada, the US Environmental Protection Agency (EPA), the US Consumer Product Safety Commission and the Italian government have all, at one time or another, proposed banning activated carbon filters used in home drinking-water treatment devices because of the growth of HPC bacteria on the carbon media and subsequent rises in HPC counts in the filtered water. After further study, however, all four decided against banning the filters. At Health Canada, the decision was made following consultations with stakeholders and was based on the absence of evidence of any illness linked to such devices. This decision was taken with the proviso that the manufacturers and distributors of activated carbon filters agree to take steps to help prevent the use of these devices on microbially unsafe waters or waters of unknown quality. In addition to growth on the carbon filter, it was shown that the filter media of some new commercial filters were already contaminated with bacteria and moulds even before being installed in homes.
- 2 Either plain or activated carbon cartridge-type filters or ceramic candles can remove protozoa (oo)cysts, provided the nominal particle retention size of the filter is 1 micron or less. However, see note 1 above. Some candle filters are impregnated with a bactericide. NZS 4348 (1995) covers the requirements for protozoa removal. WHO (2009) discusses ceramic filters, and some other treatment processes.
- 3 Activated carbon will eventually become saturated with contaminants. The carbon must then be replaced or the contaminants will start returning to the water, often at a higher concentration than in the original water.
- 4 Jugs with automatic cut-out are suitable; do not hold the cut-out switch down manually. Non-automatic jugs should be allowed to boil for a minute.
- 5 Boiling hard water removes some of the hardness (the carbonate, or temporary hardness). The hardness not removed forms a scale on the heating element making the element less efficient and advances its time of failure.
- 6 Ultraviolet disinfection becomes less effective if anything shields the microbiological contaminants from the ultraviolet light. Dissolved iron, manganese, natural organic matter (colour), or turbidity will all make UV disinfection less effective. Keep these constituents low or remove them before the water passes through the UV appliance. Treating dirty water also necessitates a lot of lamp cleaning.
- 7 Water softeners use ion exchange resins that can selectively remove specified chemicals from a range of chemical contaminants if the appropriate resins are chosen. They are available as cation, anion and mixed bed exchangers. Cation exchangers usually remove calcium hardness, replacing it with sodium. General purpose resins (mixed bed) are often not suitable for drinking-water treatment, and they tend to remove everything from the water (see note 13). A resin has been developed that removes tannin, so can be used for colour removal. See Chapter 13 for further information.
- 8 While some treatment methods work well for some contaminants, they can be upset by the presence of others. For example, ion exchange, reverse osmosis, and nanofiltration, are capable of effectively removing a range of contaminants. However, when fouled with excess turbidity and bacterial growths, their performance efficiency can fall off dramatically and they can break down. Bacteria can grow in these systems when they are not in regular use, thereby contaminating the drinking-water. Reverse osmosis and nanofiltration need daily flushing to prevent this. Reverse osmosis nearly always has an activated carbon filter upstream, and this can grow bacteria too. RO may not be appropriate in water-short areas because up to 80 percent may be wasted.
- 9 The calcium in the filter device is in the form of calcium carbonate, marble or dolomite; these dissolve, quite rapidly in some waters. Akdolite (a heat-treated dolomite) is a common brand used in New Zealand.
- 10 These calcium filter devices are of variable effectiveness depending upon exact details of filter.
- 11 Filtration processes remove arsenic if it is particulate; soluble forms require strong-base anion exchange or reverse osmosis. The ion exchange process removes most anions, replacing them with chloride; this could make the water corrosive.
- 12 Boiling will remove odours, but not necessarily taste. The chemicals that give rise to taste are not as volatile as odour chemicals.
- 13 Most people consider distilled water (and deionised water) to be insipid, and it does not provide many of the common minerals that are needed in the daily diet. Distillation requires considerable electricity usage, nearly 1 kilowatt-hour per litre.
- 14 Turbidity removal usually depends on the size of the particles that give rise to the turbidity. These can range from visible particles to very fine colloids.
- 15 The effectiveness of disinfection of viruses by UV light depends on the type of virus that is in the water. UV light only inactivates bacteria effectively if the dose is reliably high and the water clean. UV disinfection installations can inactivate protozoa effectively if they have been tested to NSF55 or DVGW. UV systems that meet the NSF standard (Class A) can be found at the website: <http://nsf.com/Certified/DWTU/>.
- 16 Oxidising systems cover a range of products from small ozone generators, greensand filters, to a variety of propriety products. Most oxidising systems will cause the iron and manganese to become particulate, so that they can then be filtered out. Most cells in Table 19.3 have not been filled in because of the variety of products available. They will range from being not very effective, to products like ozone that can also inactivate bacteria, viruses, protozoa, remove taste and odours, and maybe even reduce the colour. Small-scale package ozonation equipment is available that could be suitable for treatment of small water supplies. However, ozone is not widely used because of the high power requirements, complexity of the equipment, and relatively high capital cost.

## 19.3.5 Plumbing considerations

Plumbing requirements are covered by the Building Act 2004 and its relevant Building Codes.

See Chapter 10: Chemical Compliance, section 10.2.6 re plumbosolvency, and section 10.3.4 re discretionary monitoring which includes some discussion related to corrosion of pipes and fittings.

Chapter 16: The Distribution System, section 16.2.6 discusses permeation and leaching of chemicals into or from water pipes (mostly plastic).

MoH (2011) includes some discussion of hot water systems as they relate to the control of legionellae.

AS/NZS 3497:1998 (which was reissued in 2001 to incorporate Amendment No 1) covers plumbing requirements related to drinking-water treatment units. This will soon only be an Australian standard.

WHO (2006a) has produced a publication on health aspects of plumbing. The following paragraph is an extract from the section in Chapter 12 on domestic roof tanks:

There is considerable debate over the desirability in distributed water systems of domestic storage tanks or cisterns. An argument in favour of domestic storage is that it provides an air break that virtually excludes the possibility of back-siphonage and contamination of the public mains. Without this air break it is possible for contamination to occur whenever the mains pressure is reduced. In the event of temporary stoppage of mains supply (due to planned stoppages, breakdown or repairs), sufficient water is stored in the tank to provide domestic supply for a short period. The major disadvantage is that these tanks can become contaminated. Where distribution systems work without intermittency and the authority ensures a continuous positive pressure, fixtures connected directly to the incoming water service pipe should be preferred, avoiding the need for a tank.

DWI (2002) stated:

In Southern England it has been common practice to provide drinking water directly from the supply main at the kitchen sink only. All other taps, both hot and cold, are supplied from storage within the premises. The practice in Northern England is different where all water comes directly from the supply mains. The Water Supply (Water Quality) Regulations will require that drinking water taps in domestic premises and public buildings deliver water that is wholesome. The regulations include detailed standards for the definition of wholesome water. Storage within premises represents a risk of potential deterioration in bacterial quality. Since it is not feasible for a householder to implement a monitoring and maintenance regime similar to that carried out by water companies for their service reservoirs, compliance with quality standards cannot be reliably maintained if water is stored within consumer's premises.

Because of the risk of deterioration in drinking water quality from storage within premises, it is recommended that all supplies to the cold water taps and other cold water services in domestic premises normally used for drinking or cooking purposes should be supplied directly from the water company distribution network or from a rising main pumped either directly or indirectly from the distribution network. Where ground level storage is deemed necessary, it should be designed, sized and maintained to ensure that any stored drinking water remains wholesome at all times. Where the plumbing arrangements in existing domestic premises are renovated, the premises owner should be encouraged to design the plumbing arrangements so that all cold water supplies used for drinking or cooking purposes are connected directly to the incoming main.

## 19.4 Roof-collected rainwater supplies

### 19.4.1 Introduction

In New Zealand more than 10 percent of the population is on roof-collected rainwater systems, mostly in areas not served by municipal town supplies. Roof-collected rainwater consumption is also popular because of the general public's perception that rainwater is pure and safe to drink. The risk of disease arising from roof-collected rainwater consumption can be low, providing the water is visibly clear, has little taste or smell and, importantly, the storage and collection of rainwater is via a properly maintained storage tank and roof catchment system.

Section 19.4.2 summarises a number of national and international studies that have shown that the microbiological quality of roof-collected rainwater can be poor, often failing to meet standards.

Section 19.4.3 introduce some of the problems that can result from chemical issues.

Section 19.4.4 covers problems with rainwater catchment systems and components such as lack of maintenance, inadequate disinfection of the water, poorly designed delivery systems and storage tanks, and failure to adopt physical measures to safeguard the water against contamination. This may reflect the notion that rain is a relatively pure source of water and it may be related to the fact that in many rural areas, the availability of sufficient water for households seems to be a bigger issue than water quality. Irrespective of how roof-collected rainwater is used, the water quality is dependent on implementing a sensible maintenance programme.

Section 19.4.5 provides guidance on managing rainwater collection and storage in order to maximise the quality of water supplied from storage tanks.

Section 19.4.6 lists some readily available publications offering technical advice.

## 19.4.2 Microbiological problems

Rainwater collected and stored in domestic tanks will contain a range of micro-organisms from one or more sources. While many will be harmless, the safety of roof-collected rainwater will depend on excluding or minimising the presence of enteric pathogens. Enteric pathogens include types of bacteria such as *Salmonella* and *Campylobacter* and protozoa such as *Cryptosporidium* and *Giardia*. The likely sources of these pathogens can be faecal material deposited by birds, frogs, lizards, rodents, possums, insects, and dead animals, either in the gutters or in the tank itself, or arriving as wind-blown aerosols.

The microbiological quality of drinking-water is commonly measured by testing for *Escherichia coli* (*E. coli*), or alternatively thermo-tolerant coliforms (sometimes referred to by the less accurate term, faecal coliforms), as indicators of faecal contamination and hence the possible presence of enteric pathogens, see Chapter 5: Microbiological Quality for further information.

The following references are included to help dispel the belief that roof water is potable, therefore requiring no attention.

A study by Dennis (2002) on 60 roof-collected rainwater samples from South Wairarapa, where approximately 60 percent of the households use roof water, revealed *E. coli* transgressions in all samples on at least one occasion during a three-month period. Most samples had total coliform counts of more than 500 per 100 mL, and in two samples *E. coli* counts of greater than 550 per 100 mL were found. In a study by Sedouch (1999) on 100 roof-collected rainwater samples from the lower half of the North Island, only 18 percent of samples were found to comply with the *Drinking-water Standards for New Zealand* (DWSNZ) and 40 percent of samples were found to have failed badly with very high *E. coli* counts (> 150 per 100 mL).

Of 125 roof-collected rainwater samples from rural Auckland districts analysed between 1996 and 1998, 56 percent had faecal coliform levels that would have exceeded the 1993 WHO drinking water guidelines (Simmons et al 2001a). Significantly *Aeromonas* spp. was found in 16 percent of the samples leading the authors to conclude that this organism has potential as an alternative indicator of water quality and health risk.

In a survey of the water quality of 100 private farm rainwater supplies in Australia, varying levels of total coliforms were found in 52 percent of the water samples and 38 percent showed the presence of *E. coli* as well (Verrinder and Keleher 2001). An intensive monitoring programme in southeast Queensland showed that while roof water and *in situ* tank water exceeded the *Australian Drinking Water Guidelines* for total and faecal coliforms by a considerable margin (average tank counts of 830 and 120 per 100 mL respectively), the water quality from the hot water systems consistently produced zero levels of total and faecal coliforms (Coombes et al 2000). This study also revealed that in rainwater cisterns, the highest counts occurred immediately after major rainfall events ( $\geq 50$  mm) that washed organic material from the roof gutters into the tanks.

Several investigations in the 1980s also revealed that in many instances stored rainwater did not meet WHO, USEPA or other standards with respect to one or more bacteriological water quality indicators. In northeast Thailand, where several million people use rainwater tanks, a major study of rainwater quality by Wirojanagud et al (1989) on 189 rainwater storage tanks, revealed that only around 40 percent met WHO drinking-water standards. The faecal coliform and faecal streptococci levels in the water samples taken from roofs and gutters demonstrated that the faecal contamination was from non-human sources such as animals, birds and rodents.

Koplan et al (1978) postulated roof-collected rainwater as the possible cause of a 63-case outbreak of salmonellosis in Trinidad, West Indies, after detecting the organisms in rainwater samples and in food prepared using the rainwater.

Eight roof tank water samples were tested from rural areas near Auckland during 1975–1986. Three of the eight samples contained faecal coliforms: 17, 25 and 25 per 100 mL. Two of the three samples tested for faecal streptococci were positive (2 and 30 per 100 mL), one being in the absence of faecal coliforms. Most samples had high numbers of heterotrophic bacteria (two had more than 1000 per mL grown at 37°C for two days), probably living on the detritus washed off the roofs (Ogilvie 1994).

Simmons and Smith (1997) reported roof-collected rainwater as the probable source of *Salmonella* Typhimurium infections in a family of four in New Zealand. An investigation of an outbreak of *Salmonella enterica* serotype Typhimurium DT160 infections in humans in New Zealand (Thornley et al 2003) found that five of the 170 case-patients had consumed roof-collected rainwater in which the pathogen was also detected. In an investigation of 28 cases of gastroenteritis among 200 workers at a construction site in Queensland, *Salmonella* Saintpaul was isolated from both cases and rainwater samples (Taylor et al 2000). Animal access was suggested as source of the contamination with several live frogs being found in one of the suspect tanks.

Savill et al (2001) found the presence *Campylobacter* in 5 percent of roof water samples collected from rural locations in the North Island. In a 621 case-control multi-centre analysis of gastroenteritis induced by *Campylobacter* study in New Zealand, Eberhart-Phillips et al (1997) found that consumption of roof-collected rainwater was associated with a threefold greater risk of campylobacteriosis than that of non-consumers. In New Zealand an estimated 237 cases (2 percent) of campylobacteriosis was likely to be explained by the consumption of rainwater. Contamination of an open-topped water storage tank by faecal material from birds and bats was the most likely source of infection in an outbreak of *Campylobacter* gastroenteritis that affected 234 pupils and 23 staff at a UK boarding school over a period of eight weeks (Palmer et al 1983). An outbreak of 23 cases of *Campylobacter enteritis* on a resort island in North Queensland was probably due to the consumption of contaminated rainwater (Merrit et al 1999).

In a study on 45 water samples of roof water cisterns in the United States, Crabtree et al (1996) revealed that 48 percent were positive for *Cryptosporidium* (mean = 2.4 oocysts/100 L) and 26 percent positive for *Giardia* (mean = 1.09 cysts/100 L). In contrast, in a New Zealand study by Simmons et al (2001a) on 50 roof-collected rainwater samples, *Cryptosporidium* oocysts were detected in only two (4 percent) of the samples and no *Giardia* cysts were found in any of the samples. The authors of the latter study suggest that the difference in the results of the two studies may reflect differences in the prevalence of the protozoa in the animal reservoirs, the sources, and

the degree and frequency of faecal contamination of the catchment or rainwater storage tank. An underground rainwater storage tank was associated with a mixed outbreak of cryptosporidiosis and giardiasis in Australia in which 89 people supplied with the drinking water became ill (Lester 1992). Investigations revealed that the tank had been contaminated by an overflow from a septic tank.

Despite the fact that relatively few roof-collected rainwater-linked disease outbreaks have been reported, the indications are that there could well be under-reporting of illnesses associated with contaminated roof-collected rainwater (see Chapter 1, section 1.1.3). High levels of faecal indicator organisms are frequently detected in roof-collected rainwater as well as range of bacterial and protozoan pathogens known to cause gastroenteritis in humans. The lack of reports linking communicable disease outbreaks to roof-collected rainwater may in part be due to the fact that while rainwater use is extensive, most systems serve individual households of only a few persons. Residents experiencing sporadic gastrointestinal illnesses are less likely to seek medical attention unless the illnesses are severe and/or life threatening. Furthermore, contaminated rainwater is also more likely to be a source of sporadic disease episodes because of possible immunity in a proportion of those exposed, together with asymptomatic infection in others (Abbott 2004, Simmons et al 2001b).

In March 2006 three cases of legionella (causing one death) in a small community in south Auckland (Beachlands) were identified, resulting from three different household water supplies. These were found to have been contaminated with *L. pneumophila* SG1. The water supplies were all untreated roof-collected rainwater systems. Filters attached to taps were also contaminated. *Legionella* bacteria affect the respiratory system, often due to inhaling organisms with water vapour in a shower box. *Legionella* bacteria can grow in water when the temperature is in the range 25–60°C (approximately). Roof tank water can be kept cooler by installing the tanks on the south side of the house and selecting tanks with a light colour. The bacteria are unlikely to grow if the hot water cylinder operates at >60°C. Strictly speaking, problems due to *Legionella* bacteria (they also cause problems in some air-conditioning systems) are covered by the Building Act. Further information is included in the Datasheets 1.1: Bacteria, *Legionella*. See the Ministry of Health's 2011 publication "*The Prevention of Legionellosis in New Zealand: Guidelines for the Control of Legionella Bacteria*".

A South Korean study (Lee et al 2011) found that turbidity was the highest five minutes after the initial precipitation, and ranged from 240 to 570 NTU in all events. In the first flush of rainfall runoff at five minutes, there were significant levels of total coliforms, *E. coli*, and heterotrophic plate count organisms recorded in all events; the quality of the rainfall runoff was good after 10 minutes however.

WQRA (2010) reported the prevalence and counts of bacterial contaminants in stored rainwater in a survey in Adelaide.



| Bacterial parameter                      | Samples analysed | Prevalence n (%) <sup>1</sup> | Median | Range    |
|--|------------------|-------------------------------|--------|----------|
| Heterotrophic plate count/mL (35°C/48 h) | 974              | 961 (98.7)                    | 1200   | 0–32,000 |
| Total coliforms/100 mL <sup>2</sup>      | 973              | 802 (82.4)                    | 180    | 0–22,000 |
| <i>E. coli</i> /100 mL                   | 974              | 293 (30.1)                    | 0      | 0–2,400  |
| Enterococci/100 mL                       | 974              | 696 (71.5)                    | 6      | 0–3,200  |
| <i>Salmonella</i> spp <sup>3</sup>       | 486              | 1 (0.21)                      | NA     | NA       |
| <i>Campylobacter</i> spp <sup>4</sup>    | 486              | 0                             | NA     | NA       |
| Pathogenic <i>E. coli</i>                | 273              | 43 (15.8)                     | NA     | NA       |

1 Prevalence = 100 x (number of positive samples / total number of samples).

2 One sample was not tested for total coliform.

3 Samples (1 L) were tested weekly for *Salmonella*.

4 *Campylobacter* was tested weekly using a semi-quantitative MPN method <4 orgs/L.

The rainwater samples tested contained either *E. coli* only (2.5 percent), enterococci (43.8 percent) only, both (27.6 percent) or neither (26.1 percent). When both *E. coli* and enterococci were detected, 31.6 percent (85 of 269) of the samples had higher *E. coli* counts. Where *E. coli* was present, 33.5 percent of the samples had counts of 1 *E. coli* / 100 mL, 29.6 percent had counts of >1–10 *E. coli* / 100 mL, while 36.9 percent had levels of >10 *E. coli* / 100 mL.

## 19.4.3 Chemical problems

### Rainwater chemistry

Rainwater is nothing like distilled water! During 1982/1983 the Auckland Regional Authority Water Laboratory collected a series of monthly rainwater samples at urban sites. The rainwater had passed through a glass fibre filter so that no dry deposition was collected. During a windy month the chloride content averaged as high as 55 mg/L, the total hardness reached 20 mg/L as CaCO<sub>3</sub> and the ammonia concentration was high in the sample collected near a sewage treatment plant (Ogilvie 1994).

Urban and rural rainwater can become quite impure. Rural roofwater has been contaminated with chemicals in spray drift. The median monthly lead content of nine samples collected at Mt Eden (in Auckland) was 0.01 mg/L (ie, equalled the DWSNZ MAV), and the highest monthly result was 0.033 mg/L. Most of this lead will have resulted from motor vehicle fumes. The Mt Eden site was the most urban site but not beside a busy road. The concentration of lead was analysed in Christchurch rainwater (just rain, no dry deposition) by Stevenson (1980). Results varied from 0.005–0.031 mg/L Pb, with a mean of 0.017 mg/L, whereas rain from the Main Divide contained only 0.002 mg/L. The Christchurch and Auckland results were similar, and would have been even higher had dry deposition been included. In New Zealand about 1,500 tonnes of lead were being added to petrol per annum in the early 1980s; by 1994 it was down to around 500 tpa. The Ministry of Economic Development stated in 2005 that:

New Zealand has used lead-free petrol since 1996; only a contamination level of 13 mg/L is allowed, and this is proposed to be reduced to 5 mg/L.

The limit of detection (0.0002 mg/L) was exceeded on five of the six occasions arsenic was analysed in the Mt Eden rainwater; the maximum was 0.0022 mg/L As. Boron reached 0.2 mg/L. Arsenic and boron levels are fairly high in New Zealand coal, and both are used in wood preservation.

The ARC (2004) concluded from an Auckland study that roofs within 100 m of busy roads are likely to generate increased amounts of road transport contaminant loads. However, Adachi and Kobayashi (1992) described the results of their analysis of 117 samples of rainwater collected 1,500 m from a motorway near Kobe in Japan. Some mean values include:

- nitrate: 3.69 mg/L N
- cadmium: 0.0003 mg/L Cd
- copper: 1.52 mg/L Cu
- lead: 0.12 mg/L Pb
- nickel: 1.82 mg/L Ni
- zinc: 0.43 mg/L Zn.

The lead and nickel concentrations are well above the MAVs in the DWSNZ. Some organic chemicals such as benzene, toluene, ethylbenzene and xylene will find their way into roof tank water from motor vehicle fumes too; maybe their volatility will limit the amount that reaches water storage tanks. PAHs will deposit on roofs from chimney smoke and motor vehicle exhaust.

WQRA (2010) found 2 percent of roof water supplies in Adelaide exceeded the health-related parameter for lead (0.01 mg/L), and 26 percent exceeded the aesthetic parameter for zinc.

## Roof water chemistry

Once the rainwater lands its quality will be affected by the roof, guttering and storage system, and how these are operated and maintained.

Generally water does not sit around for long on a roof that is not flat, so the material it is constructed of probably should not have a marked effect on water quality. Two exceptions will be a new, unpainted galvanised steel roof, which will lose zinc for months, and newly painted roofs that leach detergent and other organic substances for months, causing frothing and astringent tastes in tank water.

In 1977 TJ Sprott & Associates tested four roof water samples from bitumastic-type roofs in Rodney County. They found phenolic substances that they assumed were tar derivatives in each sample at about 0.4 ppm measured as phenol. Their report concluded that the water would taste too foul to drink before it became a health risk. Some were even highly coloured.

Simmons et al (2000) found 16 percent of rural Auckland roof waters exceeded the DWSNZ MAV for lead (0.01 mg/L as Pb), despite the very low nearby traffic densities.

ARC (2004) compared the levels of copper, lead and zinc that ran off new artificial roofs made from colour steel tiles, concrete tiles, decramastic, and long run colour steel. All produced very low concentrations, <0.002 mg/L Cu, <0.001 mg/L Pb and <0.06 mg/L Zn.

ARC also examined the composition of water running off existing galvanised roofs, in conditions ranging from excellent to very poor, and unpainted. The mean concentrations of copper and lead tended to be lower on the well-painted roofs, while zinc was much lower (usually <0.2 mg/L, compared with many samples over 2 mg/L for roofs other than well-painted. Maximum total lead levels exceeded the DWSNZ MAV for all roofs in the study. The mean total lead from the fair, poor and very poor condition roofs exceeded the MAV of 0.01 mg/L Pb. One sample from a poor condition roof almost reached the MAV for cadmium of 0.004 mg/L.

## Smoke from the chimney and external fires

The discussion above referred to elevated levels of arsenic and boron, both of which can arise from the burning of coal and treated timber. Some of the smoke and soot settles on to the roof, to be washed off later by rain. Chromium was not analysed in the Auckland study; copper levels never exceeded 0.01 mg/L Cu (Ogilvie 1992).

Dungal (1961) related the high incidence of stomach cancers in a part of Iceland to the presence of polyaromatic hydrocarbons in the rainwater that was gathered from the house roofs into barrels. The houses were heated with coal and oil. The soot settled on the roofs and is washed with the rainwater into their barrels of drinking water. Quite frequently the water tasted of soot.

ARC (2004) reported fluoranthene and benzo[a]pyrene median levels commonly exceeded their (then) MAVs. Several other PAHs were reported at quite high levels too. Combustion is a common source of dioxins too.

Smoke from external fires can also affect rainwater supplies. See section 1.8 of these Guidelines re forest fires. Ash and debris deposited on a roof should be removed and the first flush of water after a fire should not be collected. Care should be taken to ensure that hatches or openings in the tops of rainwater tanks are closed or covered/sealed. If material has been washed into a tank in sufficient quantities to affect taste or appearance of rainwater, the tank will need to be drained and cleaned, or alternatively the water could be used for non-potable purposes.

Where rainwater tanks are used in bushfire-prone areas, consideration should be given to ensuring that the rainwater can be easily and quickly disconnected from the roof area for the tank. The disconnection should occur as early as possible when a bushfire is in the area so as to avoid windblown ash or debris landing on the roof area and possibly entering the tank. Reconnection of the tank to the catchment area should only occur after the fire has past and the roof area has been clear of ash and debris.

Fire retardants and foams may also be deposited on roofs. This material can be washed into tanks when water is hosed on to the roof as part of fire protecting activities, or when it rains after a bushfire. The recommended concentrations of the commonly used retardants and foams should not present a risk to health, but they may affect the taste of the water if washed into the tank. Fire retardants also contain detergents that may cause the water in the tank to froth.

## The effect of storage materials

Water from a galvanised steel roof tank near Auckland was found to contain 7 mg/L zinc (Ogilvie 1992). At this level zinc can impart a taste to the water.

Concrete tanks raise the pH, calcium and alkalinity of the water, so it is quite common to find water with a pH greater than 9.5. At this level it can kill goldfish. Water with a pH above 9 can spoil the taste of tea and coffee, and drunk on its own, can have a drying effect in the mouth.

Water from some fibreglass tanks has been associated with taste and odour problems due to organic chemicals leaching out.

A manufacturer of stainless steel and galvanised iron rainwater tanks in Tasmania had used a 50:50 lead:tin solder. Concentrations of lead from the 64 stainless steel tanks were significantly higher than from the galvanised iron tanks, with median concentrations of 121 µg/L compared with 1 µg/L respectively. The maximum lead concentration found in water from a stainless steel tank was 2030 µg/L. All stainless steel tanks had water lead concentrations above the ADWG health-related limit of 10 µg/L, only four of the 60 galvanised tanks exceed this limit; all of these four had lead flashing on roofing or lead in plumbing materials (Lodo et al 2018).

## The effect of nearby trees

Leaves falling on the roof can cause a low pH (less than 6) in the stored water, and has been implicated in the corrosion of copper service pipes. Trees can also give animals access to the roof. Generally, the main water quality problem caused by trees is the detritus that enters the tank to support large populations of bacteria, fungi and build-up the sludge layer. They can also cause the water to become coloured.

## 19.4.4 Maintenance problems

The following surveys highlight the fact that many rainwater supplies in New Zealand are designed and/or managed inappropriately. Contamination of rainwater can be minimised and even eliminated so that, with appropriately protected roof catchments and well-maintained storage tanks, high quality water can be collected.

A study by Walker (1997) of 40 private dwellings using roof water supplies in the Pauatahanui district revealed deficiencies by property owners in the use of rainwater catchment systems and components. These deficiencies included lack of maintenance, inadequate disinfection of the water, poorly designed delivery systems and storage tanks, and failure to adopt physical measures to safeguard the water against contamination.

A study on risk perception and domestic roof-collected rainwater supplies of 20 households on Waiheke Island (Fleming 2000) found that 55 percent of participants maintained their systems in terms of cleaning but the frequency of maintenance varied; only 45 percent of those participants who actually cleaned their systems had done so within the previous six months. This study also found that while 55 percent of participants did have some type of filtration system, none chemically disinfected their supplies.

A study by Breach (1996) of 20 rainwater water supplies of rural schools in South Auckland showed that only 20 percent of the schools cleaned their roofs and while 65 percent of the schools cleaned their gutters either yearly or every two to three years; only 42 percent of the schools regularly cleaned their rainwater storage tanks. Seventy-three percent of the schools did not monitor the microbiological and chemical quality of their supplies and only 9 percent of the schools disinfected their supplies with either chlorine, UV light, or filtration.

A study of 125 domestic roof-collected rainwater supplies from four rural Auckland Districts (Simmons et al 2000) showed that only 35 percent of households ever cleaned their storage tanks, and 25 percent never cleaned their catchment guttering. Forty-three percent of supplies had some type of water filtration system but only 3 percent ever used any disinfection, and then only intermittently. In 19 percent of the supplies foliage was found to overhang the roof surface.

## 19.4.5 Design and operation

### Design of collection and storage systems to minimise water quality issues

BRANZ (accessed 2014) has published a note which lists roofing materials that are suitable for rainwater collection and a list of those which are not recommended. They also offer other advice on their website, eg, at <http://www.level.org.nz/water/water-supply/mains-or-rainwater/>.

Roof materials suitable for water collection for human consumption include:

- unpainted zinc/aluminium-coated or galvanised steel
- factory-coated or painted zinc/aluminium alloy-coated or galvanised steel
- zinc
- stainless steel
- aluminium
- concrete or terracotta (clay) tiles

- copper
- PVC (without lead stabilisers) or fibreglass sheet
- untreated timber shingles (usually imported western red cedar)
- butyl rubber.

Do not use collected water for drinking if it has come into contact with:

- uncoated lead flashings (lead flashings on existing roofs should be coated with a suitable paint; coated lead is available for new roofs)
- treated timber where chemicals leaching out might contaminate the water
- bitumen-based (asphalt) roofing (note however, that BRANZ do approve some brands)<sup>2</sup>
- asbestos (although no longer used in building, existing asbestos roofs should not be used for collection of rainwater); note that the DWSNZ do not consider asbestos particles from materials used for water supply present health concerns when consumed.

Roof catchments are vulnerable to microbiological contamination by droppings of birds, frogs, lizards, rodents, possums, and contamination from dead animals and insects, either on the roofs or in the gutters. Unpleasant material can be brought to the roof by animals for feeding. Physical contamination of roof catchments can occur from windborne material, and chemical contamination from the soft corrosive water, and by leaching from inappropriate roof paints (eg, lead based) or lead flashings or some plastic gutters. Most paints and gutters are lead-free these days, but it is still advisable to check before purchasing. While roofs are being painted and for some time thereafter, disconnection of the tank is recommended during preparation and paint application and for a period immediately following application. Most reputable roof paint manufacturers provide advice on the paint container label. The lead content of paint used on roofs used for drinking-water collection should not exceed 0.1 percent and 0.2 percent (percentage based on the non-volatile content of the paint) for lead and lead compounds and lead and lead compounds occurring as an impurity in zinc based paint, respectively (MoH 2012). Care is required if fungicides or other chemicals are used for cleaning a roof.

Gutters should have sufficient and continuous fall to down pipes to prevent ponding, which can increase the accumulation of material, result in algal or slime growth, and provide a site for mosquito breeding. A fall of 1:100 should suffice. Gutter shielding devices will substantially reduce the amount of larger debris such as leaves but small particles will not be removed. Periodic cleaning of gutters will still be needed but at a lower frequency than for gutters without shielding.

<sup>2</sup> On 5 October 2015 The Ministry of Business, Innovation & Employment issued Determination 2015/056 which included: 10. The Decision. 10.1 In accordance with section 188 of the Building Act 2004 I hereby determine that asphalt roofing shingles used as part of a potable water supply system, if verified as set in paragraphs 9.4.2 to 9.4.5 of this determination, comply with Clause G12 of the Building Code in respect of chemicals or particulates leaching from the asphalt.

Before installing a rainwater tank the roof catchment should be checked for overflows, discharges and bleed-off pipes from roof-mounted appliances such as hot water systems and solar heaters. These appliances should not discharge on to the roof catchment area. Flues from slow combustion wood, coal or oil burners should be installed in accordance with the AS/NZ standards (1999).

Entry by small animals and birds to rainwater tanks can lead to direct faecal contamination, even if the animals escape from the tank. In some cases, animals become trapped in the tanks and drown, leading to high levels of contamination. In the case of larger animals such as possums, ducks and cats, this will almost certainly have an impact on the taste and odour of the water as well. Rainwater tanks can provide excellent habitats for midge and mosquito breeding, and certain types of mosquitoes can be vectors of arboviruses. Arbovirus is short for arthropod-borne virus. Arboviruses are a large group of viruses that are spread by certain invertebrate animals (arthropods), most commonly blood-sucking insects like mosquitoes and ticks. Of particular concern are species of mosquito that can be vectors of dengue fever virus, which occurs in tropical and sub-tropical regions of the world. The inlet to the tank should incorporate a screen to prevent material such as leaves and dirt that may have collected on the roof or in the gutters being washed into the tank, as well as a mesh covering to prevent access of mosquitoes and other insects. Overflows should be covered with an insect-proof mesh. The tank's contents should be inspected regularly and a cleaning programme should be established. See Figure 19.5.

A range of tanks made from different materials is available in New Zealand. Concrete and ferro-cement tanks are strong and long lasting. New tanks may impart tastes and leach lime thereby increasing the pH of water. These tanks may need to be flushed several times before use. Tanks manufactured from synthetic polymers and polyethylene are also available for rainwater storage. Plastic tanks and liners should be constructed from materials that are at least of food-grade standard, eg, compliant with AS 2070 (1999) and preferably that comply with the requirements of AS/NZS 4020 (2002).

**Figure 19.5: Minimising contamination of roof water**

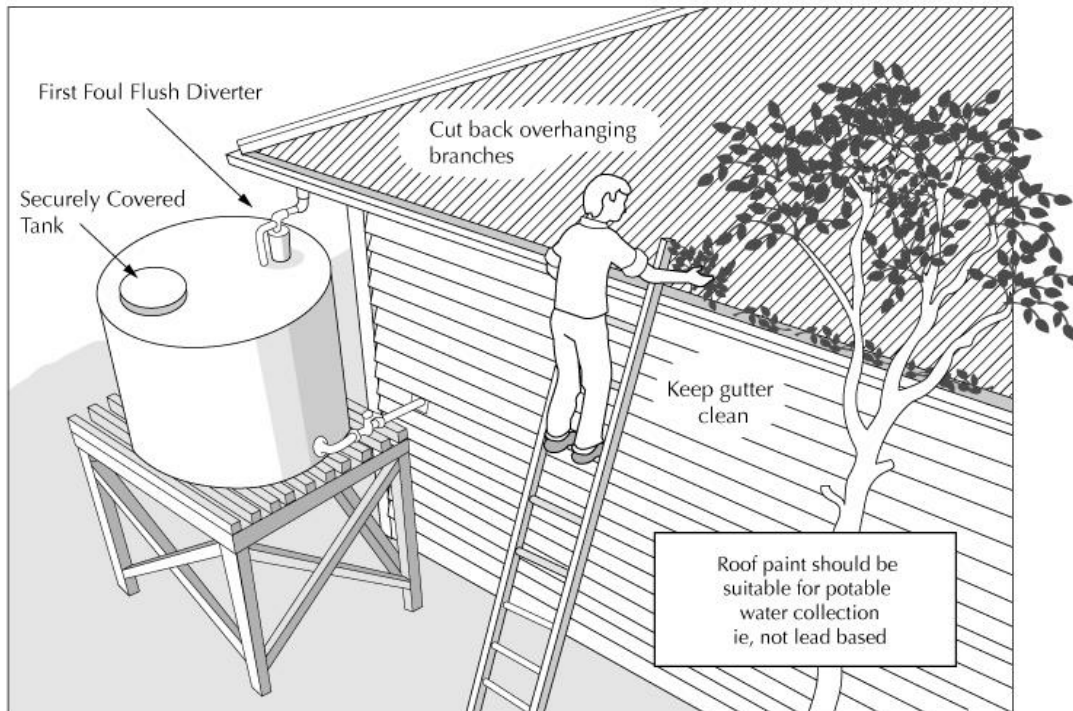

Fibreglass tanks are suitable for collecting rainwater but must be manufactured with a food grade coating on the interior surface. The coating must be cured before the tanks are offered for sale. Fibreglass and plastic tanks should be manufactured to prevent the entry of light which could encourage the growth of algae.

According to the principle of first order kinetics, tanks operating in series should reduce considerably the levels of microbial contamination of stored rainwater. Ashworth (2002; 2005) recommends that at least two tanks operating in series should be installed, including a removable drop inlet pipe arrangement and a floating arm draw off in the first tank. Free discharge of water into second or sequential tanks should result in the majority of dirt and micro-organisms being confined to the first tank. Water should exit the drop inlet pipe horizontally, 500 mm above the tank floor so as to reduce the resuspension of any sediment, and the floating arm draw off will siphon the surface water from the first tank into the second tank.

Sometimes water storage tanks are buried or partly buried. This is not a good practice. Concrete and plastic tanks can split or crack and metallic tanks can corrode, allowing contaminated groundwater or septic tank effluent to enter the tank causing illness, as pointed out in section 19.4.2 (Lester 1992). Also, unless the tank has been installed to prevent it, a high water table can push a near empty tank out of the ground.

Preventive measures and corrective actions for minimising contamination of roof-collected rainwater include:

- use a clean impervious roof made from non-toxic material
- remove and replace with approved materials any items containing toxic products (eg, lead paints, flashings, nails, etc)
- keep roof catchments clean and clear of moss, lichen, debris and leaves



- keep roof catchments clear of overhanging vegetation as branches provide roosting points for birds and can provide access for small animals such as rodents, cats and possums
- inspect gutters regularly and clean if necessary. Disconnect the pipe(s) that feed the water tank before cleaning the gutters. Exercise care when cleaning gutters; ensure the ladder is secure and avoid going anywhere near overhead power lines or better still have the power disconnected before cleaning the gutters
- if appropriate, install removable gutter guards and/or screens as well
- ensure that chimneys within or adjacent to roof water collection areas are of sufficient height to minimise the settlement of ash or residues on the roof and in the gutters
- use a coarse filter (leaf slide) and first foul flush device to intercept water entering the tank. Any roof water collection area, by virtue of its location, susceptible to undue contamination with organic material, dust, ash, sand, salt or airborne chemical residue, should have a first flush diversion system installed
- clean gutters, tank inlets and screens every three to four months
- in the event of any weed or chemical spraying in an adjacent location, advise the contractor that the roof is used to collect drinking water, and that there must be no over-spraying. Obtain a guarantee from the contractor that pesticides that present a health risk will not be used
- prevent access by small animals, birds and mosquitoes into rainwater storage tanks by screening all tank inlets as well as overflows, and keep access hatches closed
- prevent entry of surface run-off from areas other than roof catchment into below-ground tanks (see below). Tank roofs must be secure and the sides and bottom of the tank should be sealed to prevent egress
- inspect tanks annually and if necessary have tanks cleaned out professionally. See section on tank desludging, cleaning and replenishing below
- if tank contamination by faecal material is apparent the supply should be disinfected
- ensure that tank taps or draw-off pipes are at least 100 mm above the tank floor, or use a floating arm draw off valve
- do not use roof water if it is likely to be contaminated by smoke, soot or fumes from a nearby industrial process without checking its safety.

## Tank desludging, cleaning and replenishing

Accumulated sediments can be a source of microbiological and chemical contamination and can cause off-tastes and odours. Desludging water storage tanks should ideally be done by tank cleaning contractors (see telephone directory). Sludge can be removed without emptying the tank by siphoning the sludge with an inverted funnel attached to the end of a hose. Sludge can also be pumped from the tank with minimum loss of water by using a suitable pump and attachments. Alternatively, draining out and cleaning the tank can remove the sludge. Sludge can be removed continuously by installing a tank vacuum system in the tank that automatically siphons the overflow water from the bottom of the tank instead of from the top.

If it is necessary to enter the tank for cleaning, care should be taken to ensure that there is adequate ventilation and that there is an additional person in attendance. Working in a confined space such as a water tank can be dangerous because of the possibility of carbon dioxide, methane and other gases at lethal concentrations being present in the tank. Cleaning should ideally be performed by tank cleaning contractors. Cleaning should generally be limited to removing accumulated sediments and leaf litter. Cleaning agents that might release hazardous fumes should be avoided. After cleaning, the internal walls and floor of the tank should be rinsed with clean water. Rinse water and sediment should be run to waste. Further details on tank cleaning procedures can be found in the Ministry of Health's *Water Collection Tanks and Safe Household Water* booklet.

When water is delivered to replenish a storage tank, written assurance must be obtained from the water carrier that the water is from a registered source meeting the requirements of section 11 of the DWSNZ and that the water has been loaded, transported, and delivered in accordance with the requirements of the tankered drinking-water guidelines (Ministry of Health 2008). Transfer of water from the supply vehicle must not cause undue agitation of any sediment on the bottom of the tank. Water should not be transferred to any tank that is in bad state of repair or to any tank in which the residual water or sediments could adversely affect the quality of the water being transferred to the tank.

## Treatment methods

Roof-collected rainwater can be affected by contaminants that will make it undesirable or even unsafe to drink. The rainwater source needs to provide sufficient quantity to meet the requirements of the household (normally 300 litres per person per day). The water quality should be checked by an accredited laboratory. Testing will reveal the quality of the water and the treatment needed to make the water safe to use. See the Ministry of Health's *Household Water Supplies: The selection, operation, and maintenance of individual household supplies* book for full details of the contaminants, their sources, the problems they can cause, and the treatments that can be used to remove or reduce the contaminants. Some of the methods that can be used to treat roof-collected rainwater follow.

A point-of-use device is like a mini-treatment plant. It can be used to treat all the household water, or it can be put on the end of a tap for treating drinking-water only. They are effective if operated correctly. See section 19.3.4 and Table 19.3. Some common approaches include:

- boiling water in an electric kettle is an effective point-of-use technique. Boiling for one minute will remove or destroy all microbiological and most gaseous contaminants. Electric jugs with automatic cut-off are suitable especially if the water is left to cool for some minutes before use
- an under-the-bench filter at the kitchen sink is another example of a point-of-use device. There is a wide range of filters on the market that can remove micro-organisms, chemicals, and even bad tastes and taints. Before installing a point-of-use device, ensure that there is a written statement from the manufacturer as to what the device will achieve and what it will not achieve in the way of purification. The device should provide some means of indicating when it will no longer function

according to specification. It is important to adhere rigidly to the manufacturer's maintenance instructions. Check that it complies with AS/NZS 3497 and has been tested to AS/NZS 4348 for the purpose which the appliance is to be used. Ultraviolet light can be used to disinfect rainwater by treating microbiological contaminants so that they are unable to reproduce. The UV disinfection unit can be installed in the pipework delivering water from a storage tank to a dwelling, or selectively to taps used to supply water for drinking and food preparation. An ultraviolet light point-of-use device must be used with relatively clean water to enable the light beam to penetrate with sufficient intensity throughout the reaction chamber. The lamps degrade with time and must be replaced on a six-monthly to yearly basis. The intensity of UV radiation emitted decreases with lamp age; typical lamp life is about 10 to 12 months after which the output is about 70 percent of that of a new lamp, and lamp replacement is required. If UV light is used, it is important to install a system incorporating a sensor that indicates when the device is or is not operational. See Chapter 15: Disinfection Processes, section 15.5.5 for further information.

## Chlorination

Regular chlorination of roof-collected rainwater stored in domestic household tanks is not considered appropriate in most cases and is generally only recommended as a remedial action. The effectiveness of chlorine is short-lived and will only act on water in the tank at the time of dosing. Fresh rain run-off into the tank after chlorination will probably not be disinfected.

The Ministry of Health's *Household Water Supplies: The selection, operation, and maintenance of individual household supplies* book provides full details on how to calculate the dosages required for disinfection using sodium hypochlorite (plain household bleach, usually about 3 percent available chlorine) or calcium hypochlorite (swimming pool chlorine).

To achieve effective disinfection, it is necessary to add sufficient chlorine to provide a free chlorine residual of at least 0.5 mg/L after a contact time of at least 30 minutes. This can be measured using a suitable chlorine test kit (eg, a swimming pool kit) if available.

As a guide, the addition of 40 mL of liquid sodium hypochlorite (12.5 percent available chlorine) per 1,000 L of water or 7 g of granular calcium chloride (75 percent available chlorine) per 1,000 L of water will give a reasonable assurance of effective disinfection. Both methods will provide chlorine doses of approximately 5 mg/L. Sodium and calcium hypochlorite can be purchased from large supermarkets, hardware stores or swimming pool stockists. When handling and storing strong chemical compounds it is important to follow safety instructions given on the package label.

When adding the chemical solution to the tank, spread it as widely as possible across the surface to promote mixing (this will often be limited by restricted access) and let it stand for at least one hour before using the disinfected water. The chlorine will impart a distinct taste and odour that should dissipate in a few days. Boiling the water will remove most of the taste and odour associated with chlorination.

## 19.4.6 Information resources

A number of information resources on the safe collection and storage roof-collected rainwater systems have been published including material available on the internet:

- *Water Collection Tanks and Safe Household Water*. Ministry of Health 1999; Code 10148. This booklet outlines the steps involved the safe collection and storage of rainwater.
- *Household Water Supplies: The selection, operation, and maintenance of individual household supplies*. Ministry of Health 2004 Code 4602. This book presents information on the supply of safe drinking-water to households not connected to town supplies. Information on water sources and treatment options are included.
- *Public Health Risk Management Plan Guide: Roof water sources*. Ministry of Health 2001 Ref S1.2. This guide covers many of the causes of contamination of roof water and the preventive measures and corrective actions that are necessary to ensure the safety of the water supply. Included are contingency plans such as when roofs are contaminated by spray drift, volcanic ash, and contingencies for water shortage events. See also the worked example, Ref W1.
- *Codes of Practice for Private Rainwater Supplies*. Sarfai 1997. This non-mandatory code was developed for the Southland District Council for use as a building compliance guidance document for the potable water requirement of the Building Act.
- *Tank Water Supply Design Guide*. Ashworth 2002. This book is intended to help householders or small businesses that collect roof rainwater or surface water, to improve their water quality.
- *Rainwater Tank Supply Best Practice*. Ashworth 2005. This book simplifies the above design guide, putting forward the preferred systems to achieve a wholesome water supply to serve communities of fewer than 25 people.
- *Guidance on the Use of Rainwater Tanks*. EnHealth 2010, third edition. This Australian monograph consolidates the most up-to-date information and advice as a resource for Environmental Health Officers and other professionals, and for those members of the public seeking detailed guidance on safe rainwater collection and storage.
- The NSW Government published the *NSW Guideline on use of rainwater where a public water supply is available*. See <http://www.health.nsw.gov.au/environment/water/Pages/rainwater.aspx>.
- *Rainwater Catchment Systems for Domestic Supply: Design, construction and implementation*. Gould and Nissen-Petersen 1999. This very detailed book focuses on technical options for improving rainwater collection and storage. It provides an extensive review of recent developments and lessons learnt with respect to rainwater catchments systems for domestic supply.
- *Sustainable Water from Rainwater Harvesting*. Wade 2003. This is an information booklet about simple, cost effective and revolutionary designed products for leaf and debris diversion/exclusion/removal systems for household and industrial use.

- *Public Health Aspects of Rainwater Tanks in Urban Australia*. CRC 2005. Recent drought and ongoing concerns about the sustainability of water supplies have resulted in increased interest in the installation of rainwater tanks in urban areas. Given the potential that this may lead to increased consumption of rainwater even in areas where a treated public drinking water supply is available, health authorities are concerned that the potential health risks should be better documented and understood, particularly with respect to any differences in rainwater quality that may exist between urban and rural settings.

## 19.5 Tankered drinking-water supplies

The tankered drinking-water carriers formed a voluntary group: the Tankered Drinking Water Carriers Association Incorporated (TDWCAI). In July 2008 the Ministry of Health, in conjunction with the TDWCAI, published the *Guidelines for the Safe Carriage and Delivery of Drinking-water*. The latest version of that publication is available at <https://www.health.govt.nz/publication/guidelines-safe-carriage-and-delivery-drinking-water>.

By following the Guidelines, applying best practice, and implementing a water safety plan, tankered drinking water suppliers can demonstrate that they have taken all practicable steps to comply with the Health Act 1956.

WHO (2011b) includes Technical Note 12 titled *Delivering Safe Water by Tanker*. The NSW Government published the *NSW Guidelines for Water Carters* in 2012, see <http://www.health.nsw.gov.au/environment/water/Pages/nsw-guidelines-for-water-carters.aspx>.

## 19.6 Rural agricultural drinking-water supplies

The drinking-water provisions of the Health Act 1956 include a new category of water supply: Rural Agricultural Drinking-water Supplies (RADWS). The *Rural Agricultural Drinking-water Supply Guideline* was published in March 2015 (<https://www.health.govt.nz/publication/rural-agricultural-drinking-water-supply-guideline>). The Guideline includes a decision tree that determines if a water supply is a RADWS.

This Guideline gives water suppliers flexibility in demonstrating compliance with the requirements of the drinking-water provisions of the Act. By following the Guideline, applying best practice, and implementing a water safety plan, rural agricultural water suppliers can demonstrate that they have taken all practicable steps to comply with the Health Act 1956.

## References

- Abbott SE. 2004. Microbiological health risks of roof-collected rainwater. *Water & Wastes in New Zealand* 134(May): 26–7.
- Adachi A, Kobayashi T. 1992. Influence of motor vehicle exhausts on chemical components in rainwater. *Wat Sci Tech* 26(9–11): 2563–6.
- ARC. 2004. *A Study of Roof Runoff Quality in Auckland, New Zealand*. Technical Publication No. 213. Auckland Regional Council. New Zealand.  
<http://www.aucklandcouncil.govt.nz/EN/planspoliciesprojects/reports/technicalpublications/Pages/technicalpublications201-250.aspx>.
- Ashworth J. 2002. *Tank Water Supply Design Guide* (2nd edition). Glenfield, New Zealand: Ashworth.
- Ashworth J. 2005. *Rainwater Tank Supply Best Practice: Serving communities of 25 people or less*. Glenfield, New Zealand: Ashworth.
- AS 2070. 1999. *Plastic Materials for Food Contact Use*.
- AS/NZS 4348. 1995. *Water Supply – Domestic type water treatment appliances – Performance requirements* (currently under review).
- AS/NZS 3497. 1998. *Domestic Type Water Treatment Appliances*. Amendment 1:2001, Drinking water treatment units – plumbing requirements.
- AS/NZS 3869. 1999. *Domestic Solid Fuel Burning Appliances – Safe design and construction*.
- AS/NZS 4012 and 4013. 1999. *Provide a Range of Methods Designed to Assess Emission Limits, Power Output and Efficiency of Woodburners*.
- AS/NZS 4020. 2002. *Testing Products for Use in Contact with Drinking Water*.
- AWWA. 1999. *Design and Construction of Water Systems: An AWWA Small System Resource Book* (2nd edition). Denver CO: American Water Works Association.
- BRANZ (accessed December 2014). Water use, sustainability, and efficiency by choosing quality systems and materials, and providing environmentally friendly solutions. BRANZ. <http://www.level.org.nz/water/water-supply/mains-or-rainwater/harvesting-rainwater/>.
- Breach LJ. 1996. *A Study to Investigate Rural School Water Supplies in South Auckland*. BAppSc NBSEH 3330 Environmental Health Research Project. Wellington Polytechnic.

British Columbia. 2007. *Application of 'Point of Entry' and 'Point of Use' Water Treatment Technology in British Columbia*. Prepared for the British Columbia Ministry of Health. 104 pp. [http://www.health.gov.bc.ca/protect/poureport\\_main.pdf](http://www.health.gov.bc.ca/protect/poureport_main.pdf).

CDC. 2009. Emergency Disinfection of Drinking Water. [http://www.cdc.gov/healthywater/drinking/travel/emergency\\_disinfection.html](http://www.cdc.gov/healthywater/drinking/travel/emergency_disinfection.html).

Coombes P, Argue J, Kuczera G. 2000. *Rainwater Quality from Roofs, Tanks and Hot Water Systems at Fig Tree Place*. Perth: Third International Hydrological and Water Resources Symposium, pp 1042–7.

Crabtree K, Ruskin R, Shaw S, et al. 1996. The detection of *Cryptosporidium* oocysts and *Giardia* cysts in cistern water in the US Virgin Islands. *Water Research* 30: 208–16.

CRC. 2005. *Public Health Aspects of Rainwater Tanks in Urban Australia*. CRC for Water Quality and Treatment Occasional Paper 10. 90 pp. [www.waterquality.crc.org.au](http://www.waterquality.crc.org.au).

CRC. 2007. *Point of Entry/Use Treatment for the Delivery of Potable Water*. CRC for Water Quality and Treatment. Research Report 50. 104 pp. Cooperative Research Centre for Water Quality and Treatment, Australia. <http://www.waterquality.crc.org.au>.

Dennis J. 2002. *A Survey to Assess the Bacterial Quality of Roof-collected Rainwater in the Wairarapa*. BHIthSc 214.318 Environmental Health Research Project. Massey University, Wellington, New Zealand.

Dungal N. 1961. The special problem of stomach cancer in Iceland. *Journal of the American Medical Association* 178(8): 93–102.

DWI. 2001. *Manual on Treatment for Small Water Supply Systems*. DETR/DWI 4936/1. 138 pp. [http://dwi.defra.gov.uk/research/completed-research/reports/DWI70\\_2\\_137\\_manual.pdf](http://dwi.defra.gov.uk/research/completed-research/reports/DWI70_2_137_manual.pdf).

DWI. 2002. *Review of the Benefits and Disbenefits for Drinking Water Storage within Premises*. DWI 70/2/150. 46 pp. [http://dwi.defra.gov.uk/research/completed-research/reports/DWI70\\_2\\_150\\_storage%20within%20premises.pdf](http://dwi.defra.gov.uk/research/completed-research/reports/DWI70_2_150_storage%20within%20premises.pdf).

DWI. 2016. Comparison of Private Water Supply and Public Water Supply Ultraviolet (UV) Systems: Final Report. Report Reference: DEFRA10932.05. 177 pp. <http://dwi.defra.gov.uk/research/completed-research/reports/DWI70-2-306.pdf>.

Eberhart-Phillips J, Walker N, Garret N, et al. 1997. Campylobacteriosis in New Zealand: results of a case control study. *Journal of Epidemiology and Community Health* 51: 686–91.

EnHealth. 2010. *Guidance on Use of Rainwater Tanks*. 3rd edition, 64 pp. Australian Government Department of Health. <http://www.health.gov.au/internet/main/publishing.nsf/Content/ohp-enhealth-raintank-cnt.htm>.

Fleming J. 2000. *Risk Perception and Domestic Roof-collected Rainwater Supplies*. Master of Public Health Thesis. Auckland University, New Zealand.

Gould J, Nissen-Petersen E. 1999. *Rainwater Catchment Systems for Domestic Supply: Design, construction and implementation*. London: Immediate Technology Publications Ltd.

Koplan J, Deen R, Swanston W, et al. 1978. Contaminated roof-conducted rainwater as a possible case of an outbreak of Salmonellosis. *Journal of Hygiene* 45: 303–9.

Lee JY, Kim HJ, Han MY. 2011. Quality assessment of rooftop runoff and harvested rainwater from a building catchment. *Water Science and Technology* 63(11): 2725–31. See summary in *Healthstream* September 2011: [www.wqra.com.au](http://www.wqra.com.au).

Lester R. 1992. A mixed outbreak of cryptosporidiosis and giardiasis. *Update* 1: 14–15.

Lodo K, Dalgleish C, Patel M, et al. 2018. A novel public health threat – high lead solder in stainless steel rainwater tanks in Tasmania. *Australian and New Zealand Journal of Public Health* 42(1): 77–82.

Merrit A, Miles R, Bates J. 1999. An outbreak of *Campylobacter enteritis* on an island resort, North Queensland. *Communicable Disease Intelligence* 23: 215–19.

Ministry of Economic Development. 2005. *Petrol Properties and Changes Proposed*. Updated 19 December 2005.

Ministry of Health. 1999, various subsequent revisions. *Water Collection Tanks and Safe Household Water*. Code 10148. Wellington: Ministry of Health.  
<https://www.health.govt.nz/your-health/healthy-living/drinking-water/household-water-supplies>.

Ministry of Health. 2000. *Secure Groundwater Bores and Wells for Safe Household Water*. Wellington: Ministry of Health.

The New Zealand Ministry of Health’s Guides for drinking-water supplies can be accessed as Word documents on the Ministry of Health website:  
<http://www.health.govt.nz/water> then select publications and Water Safety Plans. Some DVDs and booklets are listed in section 19.2.2. See also  
<http://www.health.govt.nz/publication/water-safety-plan-guides-drinking-water-supplies>.

Ministry of Health. *Public Health Risk Management Plan Guide PHRMP Ref S1.2. Roof Water Sources*. Wellington: Ministry of Health.

Ministry of Health. *Public Health Risk Management Plan Guide PHRMP Ref: D2.4. Distribution System – Backflow Prevention*. Wellington: Ministry of Health.

Ministry of Health. *Worked Example of a Public Health Risk Management Plan for a Small Supply Using Rainwater*. Ref: W1. Wellington: Ministry of Health.

Ministry of Health. *Worked Example of a Public Health Risk Management Plan for a Small Supply Using Chlorinated Groundwater*. Ref: W2. Wellington: Ministry of Health.

Ministry of Health. 2001. *How to Prepare and Develop Public Health Risks Management Plans for Drinking-water Supplies*. Wellington: Ministry of Health. Available at: <http://www.health.govt.nz/water> then select publications.

Ministry of Health. 2001. *Model Public Health Risks Management Plan Guides*. Wellington: Ministry of Health. Available at: <http://www.health.govt.nz/water> then select publications.

Ministry of Health. 2002. *An Introduction to Risk Management Planning: Small Community Drinking-water Supplies*. A video. Wellington: Ministry of Health.



Ministry of Health. 2004, various subsequent revisions. *Household Water Supplies: The selection, operation, and maintenance of individual household supplies*. Code 4602. Wellington: Ministry of Health.

Ministry of Health. 2005. *Drinking-water Standards for New Zealand*. Wellington: Ministry of Health. Revised 2008 and 2018.

Ministry of Health. 2005. *A Small Supplier's Guide to Developing a Plan to Ensure Safe Drinking-water template*. Wellington: Ministry of Health.

Ministry of Health. 2005. *A Small Supplier's Guide to Developing a Plan to Ensure Safe Drinking-water*. A video, available from the Ministry of Health.

Ministry of Health. 2005. *Small Drinking-water Supplies – How to Prepare a PHRMP*. Available at: <http://www.health.govt.nz/water> then select publications.

Ministry of Health. 2007. *Treatment Options for Small Drinking-water Supplies*. 45 pp. Wellington: Ministry of Health. <http://www.health.govt.nz/publication/treatment-options-small-drinking-water-supplies>.

Ministry of Health. 2008. *Drinking-Water Standards for New Zealand*. Wellington: Ministry of Health.

Ministry of Health. 2008. *Guidelines for the Safe Carriage and Delivery of Drinking-water*. Wellington: Ministry of Health.

Ministry of Health. 2010a. *Design and Operation of Bores for Small drinking-Water Supplies: Resources for Drinking-water Assistance Programme*. Wellington: Ministry of Health. 25 pp.

[http://www.health.govt.nz/system/files/documents/publications/design-operation-bores-small-drinking-water-supplies-2010\\_0.pdf](http://www.health.govt.nz/system/files/documents/publications/design-operation-bores-small-drinking-water-supplies-2010_0.pdf).

Ministry of Health. 2010b. *Operation and Maintenance of a Small Drinking-water Supply: Resources for Drinking-water Assistance Programme*. Wellington: Ministry of Health. 30 pp.

<http://www.health.govt.nz/system/files/documents/publications/operation-maintenance-small-drinking-water-supply2010-jan14.pdf>.

Ministry of Health. 2010c. *Managing Projects for Small Drinking-water Supplies: Resources for Drinking-water Assistance Programme*. Wellington: Ministry of Health. 28 pp.

[http://www.health.govt.nz/system/files/documents/publications/managing-projects-for-small-drinking-water-supplies-2010\\_0.pdf](http://www.health.govt.nz/system/files/documents/publications/managing-projects-for-small-drinking-water-supplies-2010_0.pdf).

Ministry of Health. 2010d. *Pumps, Pipes and Storage: Resources for Drinking-water Assistance Programme*. Wellington: Ministry of Health. 46 pp.

[http://www.health.govt.nz/system/files/documents/publications/pumps-pipes-and-storage2010\\_0.pdf](http://www.health.govt.nz/system/files/documents/publications/pumps-pipes-and-storage2010_0.pdf).

Ministry of Health. 2010e. *UV Disinfection and Cartridge Filtration: Resources for Drinking-water Assistance Programme*. Wellington: Ministry of Health. 24 pp.

[http://www.health.govt.nz/system/files/documents/publications/uv-disinfection-and-cartridge-filtration\\_0.pdf](http://www.health.govt.nz/system/files/documents/publications/uv-disinfection-and-cartridge-filtration_0.pdf).

Ministry of Health. 2011. *The Prevention of Legionellosis in New Zealand: Guidelines for the Control of Legionella Bacteria*. 115 pp. Published by the Ministry of Health, Wellington.

<http://www.health.govt.nz/system/files/documents/publications/prevention-of-legionellosis-in-new-zealand-v2.pdf>.

Ministry of Health. 2012. *The Environmental Case Management of Lead-exposed Persons: Guidelines for Public Health Units: Revised 2012*. 136 pp. Wellington: Ministry of Health. <http://www.health.govt.nz/publication/environmental-case-management-lead-exposed-persons>.

Ministry of Health. 2014a. *A Framework on How to Prepare and Develop Water Safety Plans for Drinking-water Supplies*. Wellington: Ministry of Health.

<http://www.health.govt.nz/system/files/documents/publications/framework-water-safety-plans-jan14.pdf>.

Ministry of Health. 2014b. *Small Drinking-water Supplies: Preparing a water safety plan*. Wellington: Ministry of Health.

<http://www.health.govt.nz/system/files/documents/publications/small-drinking-water-supplies-jan14.pdf>.

Ministry of Health. 2015. *Rural Agricultural Drinking-water Supply Guideline*.

Wellington: Ministry of Health. 12 pp. <http://www.health.govt.nz/publication/rural-agricultural-drinking-water-supply-guideline>.

Ministry of Health. 2018. *Drinking-Water Standards for New Zealand*. Wellington: Ministry of Health.

NSF/ANSI 44-2004. *Residential Cation Exchange Water Softeners*. Ann Arbor, Michigan: NSF International. <http://www.nsf.org>.

NSF/ANSI 55-2004. *Ultraviolet Microbiological Water Treatment Systems*. Ann Arbor, Michigan: NSF International. <http://www.nsf.org>.

NSF/ANSI 62-2004. *Drinking Water Distillation Systems*. Ann Arbor, Michigan: NSF International. <http://www.nsf.org>.

NSF/ANSI 42-2005e. *Drinking Water Treatment Units: Aesthetic effects*. Ann Arbor, Michigan: NSF International. <http://www.nsf.org>.

NSF/ANSI 53-2006. *Drinking Water Treatment Units: Health effects*. Ann Arbor, Michigan: NSF International. <http://www.nsf.org>.

NSF/ANSI 58-2006. *Reverse Osmosis Drinking Water Treatment Systems*. Ann Arbor, Michigan: NSF International. <http://www.nsf.org>.

NZWWA/NZWERF. 2002. *New Zealand Small Water Systems Survey*. 78 pp. Wellington: New Zealand Water and Wastes Association.

Ogilvie DJ. 1994. *The Quality of Auckland's Roof Water and Rainwater*. Report to the Auckland Medical Officers of Health. August.

Palmer SR, Gully PR, White JM, et al. 1983. Waterborne outbreak of *Campylobacter* gastroenteritis. *Lancet* 327: 287–90.

- Sarfaiti M. 1997. Codes of practice for private rainwater supplies. *New Zealand Journal of Environmental Health* October: 17–21.
- Savill MG, Hudson JA, Ball A, et al. 2001. Enumeration of *Campylobacter* in New Zealand recreational and drinking waters. *Journal of Applied Microbiology* 91: 38–46.
- Sedouch V. 1999. *Total Coliform and Faecal Coliform Detection in Roof Water*. BAppSc 3330 NBSEH Environmental Health Research Project. Massey University, Wellington, New Zealand.
- Simmons G, Smith J. 1997. Roof water probable source of *Salmonella* infections. *The New Zealand Public Health Report* 4: 5.
- Simmons G, Gould J, Gao W, et al. 2000. The design, operation and security of domestic roof-collected rainwater in rural Auckland. *Proceedings of the Water 2000 Conference 'Guarding the Global Resource'*. Auckland: New Zealand Water and Wastes Association. Session 3; pp 1–16.
- Simmons G, Hope V, Lewis G, et al. 2001a. Contamination of potable roof-collected rainwater in Auckland, New Zealand. *Water Research* 35: 1518–24.
- Simmons G, Heyworth J, Rimajova M. 2001b. Assessing the microbial health risks of tank rainwater used for drinking water. *Environmental Health* 3: 57–64.
- Stevenson DG. 1980. The lead content and acidity of Christchurch precipitation. *New Zealand Journal of Science* 23: 311–12.
- Taylor R, Sloan D, Cooper T, et al. 2000. A waterborne outbreak of *Salmonella saintpaul*. *Communicable Disease Intelligence* 24: 336–40.
- Thornley CN, Simmons GC, Callaghan ML, et al. 2003. First incursion of *Salmonella enterica* serotype DT160 into New Zealand. *Emerging Infectious Diseases* 9: 493–5.
- USEPA. 2003. *Small Drinking Water Systems Handbook: A guide to 'packaged' filtration and disinfection technologies with remote monitoring and control tools*. EPA/600/R-03/041. Office of Research and Development. Water Supply and Water Resources Division, United States Environmental Protection Agency. See: <http://www.epa.gov/nrmrl/pubs/600r03041.html> or Google title.
- USEPA. 2006. *Investigation of the Capability of Point-of-Use/Point-of-Entry Treatment Devices as a Means of Providing Water Security*. EPA/600/R-06/012, February 2006. USEPA, Office of Research and Development, National Homeland Security Research Center. See: <http://www.epa.gov/nhsrc/pubs.html> and select Treatment and Disposal.
- USEPA. 2006a. *Point-of-Use or Point-of-Entry Treatment Options for Small Drinking Water Systems*. EPA 815-R-06-010. 132 pp. US Environmental Protection Agency, Office of Ground Water and Drinking Water, Standards and Risk Management Division. [http://www.epa.gov/ogwdw000/smallsystems/pdfs/guide\\_smallsystems\\_pou-poe\\_june6-2006.pdf](http://www.epa.gov/ogwdw000/smallsystems/pdfs/guide_smallsystems_pou-poe_june6-2006.pdf).
- USEPA. 2007. *Cost evaluation of point-of-use and point-of-entry treatment units for small systems: cost estimating tool and user guide*. EPA 815-B-07-001. 37 pp. [http://www.epa.gov/ogwdw/smallsystems/pdfs/tool\\_smallsystems\\_cost-tool-usersguidepdf.pdf](http://www.epa.gov/ogwdw/smallsystems/pdfs/tool_smallsystems_cost-tool-usersguidepdf.pdf).

Verrinder G, Keleher H. 2001. Domestic drinking water in rural areas; are water tanks on farms a health hazard? *Environmental Health* 1: 51–6.

Wade R. 2003. *Sustainable Water from Rainwater Harvesting* (3rd edition). Queensland: Environmental Conservation Planning.

Walker TJ. 1997. *A Study to Evaluate the Physical Fitness of Roof Catchment Water Supplies in the Rural District of Pauatahanui*. BAppSc NBSEH 3330 Environmental Health Research Project. Wellington Polytechnic.

*Water and Wastes in New Zealand*. 1995. For information about point-of-use devices. July and November issues (Nos 86 and 88).

WHO. 2002. *Managing Water in the Home: Accelerated Health Gains from Improved Water Supply*. WHO/SDE/WSH/02.07. Geneva: World Health Organization: Department of Protection of the Human Environment. Available at:  
[http://www.who.int/water\\_sanitation\\_health/dwq/WSH02.07.pdf](http://www.who.int/water_sanitation_health/dwq/WSH02.07.pdf).

WHO. 2003. *Heterotrophic Plate Counts and Drinking-Water Safety: The significance of HPCs for water quality and the human health*. IWA Publishing. Available at  
[http://www.who.int/water\\_sanitation\\_health/dwq/hpc/en/index.html](http://www.who.int/water_sanitation_health/dwq/hpc/en/index.html).

WHO. 2004. *Guidelines for Drinking-water Quality 2004* (3rd edition). Geneva: World Health Organization. Available at:  
[www.who.int/water\\_sanitation\\_health/dwq/gdwq3/en/print.html](http://www.who.int/water_sanitation_health/dwq/gdwq3/en/print.html) see also the addenda.

WHO. 2006a. *Health Aspects of Plumbing*. World Health Organization and the World Plumbing Council. ISBN 92 4 156318 4. 139 pp. Available on the internet at:  
[www.who.int/water\\_sanitation\\_health/publications/plumbinghealthasp/en/index](http://www.who.int/water_sanitation_health/publications/plumbinghealthasp/en/index).

WHO. 2006b. *The International Network to Promote Household Water Treatment and Safe Storage*. Available at [www.who.int/household\\_water](http://www.who.int/household_water).

WHO. 2007. *Combating Waterborne Disease at the Household Level*. International Network to Promote Household Water Treatment and Safe Storage, World Health Organization. 36 pp.  
[http://www.who.int/household\\_water/advocacy/combating\\_disease.pdf](http://www.who.int/household_water/advocacy/combating_disease.pdf).

WHO. 2009. *Scaling Up Household Water Treatment Among Low-Income Populations*. 84 pp. [http://whqlibdoc.who.int/hq/2009/WHO\\_HSE\\_WSH\\_09.02\\_eng.pdf](http://whqlibdoc.who.int/hq/2009/WHO_HSE_WSH_09.02_eng.pdf).

WHO. 2009a. *Water, Sanitation and Hygiene Standards for Schools in Low-cost Settings*. 51 pp. [www.who.int/water\\_sanitation\\_health/publications/en/index.html](http://www.who.int/water_sanitation_health/publications/en/index.html).

WHO. 2011. *Evaluating Household Water Treatment Options: Health-based targets and microbiological performance specifications*. 68 pp.  
[http://www.who.int/water\\_sanitation\\_health/publications/2011/evaluating\\_water\\_treatment.pdf](http://www.who.int/water_sanitation_health/publications/2011/evaluating_water_treatment.pdf).

WHO. 2011a. *Water Safety in Buildings*. Geneva: World Health Organization. 164 pp.  
[http://www.who.int/water\\_sanitation\\_health/publications/en/](http://www.who.int/water_sanitation_health/publications/en/).

WHO. 2011b. *WHO Technical Notes on Drinking-water, Sanitation and Hygiene in Emergencies*.  
[http://www.who.int/water\\_sanitation\\_health/dwq/publications/en/index.html](http://www.who.int/water_sanitation_health/dwq/publications/en/index.html).

WHO. 2011c. *Guidelines for Drinking-water Quality* (4th edition). Geneva: World Health Organization. Available at:

[http://www.who.int/water\\_sanitation\\_health/publications/2011/dwq\\_guidelines/en/index.html](http://www.who.int/water_sanitation_health/publications/2011/dwq_guidelines/en/index.html).

WHO. 2012. *Water Safety Planning for Small Community Water Supplies Step-by-step Risk Management Guidance for Drinking-water Supplies in Small Communities*. 66 pp. [http://www.who.int/water\\_sanitation\\_health/publications/2012/water\\_supplies/en/index.html](http://www.who.int/water_sanitation_health/publications/2012/water_supplies/en/index.html).

WHO. 2012a. A toolkit for monitoring and evaluating household water treatment and safe storage programmes. WHO/UNICEF. 76 pp.

[http://www.who.int/household\\_water/resources/toolkit\\_monitoring\\_evaluating/en/](http://www.who.int/household_water/resources/toolkit_monitoring_evaluating/en/) or

[http://apps.who.int/iris/bitstream/10665/76568/1/9789241504621\\_eng.pdf?ua=1](http://apps.who.int/iris/bitstream/10665/76568/1/9789241504621_eng.pdf?ua=1).

WHO. 2014. *Water safety plan: a field guide to improving drinking-water safety in small communities*. World Health Organization Regional Office for Europe. 100 pp.

<http://www.euro.who.int/en/health-topics/environment-and-health/water-and-sanitation/publications/2014/water-safety-plan-a-field-guide-to-improving-drinking-water-safety-in-small-communities>.

WHO. 2016. Results of Round 1 of the WHO International Scheme to Evaluate Household Water Treatment Technologies. World Health Organization. ISBN 978 92 4 150994 7; 64 pp. [http://www.who.int/household\\_water/scheme/household-water-treatment-report-round-1/en/](http://www.who.int/household_water/scheme/household-water-treatment-report-round-1/en/) or go to

[http://www.who.int/water\\_sanitation\\_health/publications/en/](http://www.who.int/water_sanitation_health/publications/en/).

WHO. 2017. *Guidelines for drinking-water quality: fourth edition incorporating the first Addendum*. Geneva: World Health Organization. 631 pp.

[http://www.who.int/water\\_sanitation\\_health/publications/drinking-water-quality-guidelines-4-including-1st-addendum/en/](http://www.who.int/water_sanitation_health/publications/drinking-water-quality-guidelines-4-including-1st-addendum/en/).

Wirojanagud W, Hovichitr P, Mungkarndee P. 1989. *Evaluation of Rainwater Quality: Heavy metals and pathogens*. Ottawa: IDRC. 103 pp.

WQRA. 2010. Quality of stored rainwater used for drinking in metropolitan South Australia. Research Report 84. 56 pp.

<http://www.waterra.com.au/publications/featured-publications/>.